

CG304T/S



FEATURES

Maintain control with dual-stacked burners that go from 18,000 Btu down to a mere breath of flame

Simmer and melt sauces, soups, and marinades easily with the lower tier of the dual-stacked burner

Makes an attractive statement even when installed alone

Reignites flame automatically with spark ignition system

Cleanup is a snap as sealed, seamless burner pans contain splashes and spills

Move pots and pans effortlessly across the continuous cast-iron grates

ACCESSORIES

2-Burner Wok Grate

30" Professional Grate Set

High altitude conversion kits available

Accessories available through an authorized dealer.
For local dealer information, visit subzero-wolf.com/locator.



COOKTOP SPECIFICATIONS

- 2 - 9,200 Btu Burner
- 1 - 12,000 Btu Burner
- 1 - 18,000 Btu Burner

PRODUCT SPECIFICATIONS

Model	CG304T/S
Dimensions	30"W x 4"H x 21"D
Weight	56 lbs
Electrical Supply	120 VAC, 60 Hz
Electrical Service	15 amp dedicated circuit
Gas Supply	3/4" ID line
Gas Inlet	1/2" NPT female

ELECTRICAL

GAS

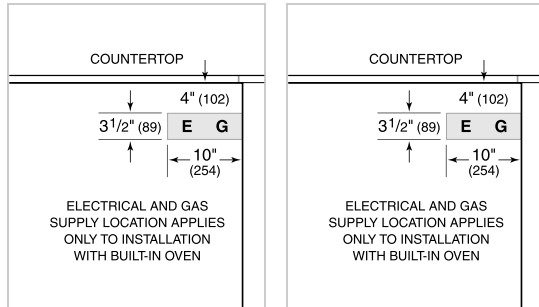

NOTE: Dimensions in parenthesis are in millimeters unless otherwise specified

DIMENSIONS

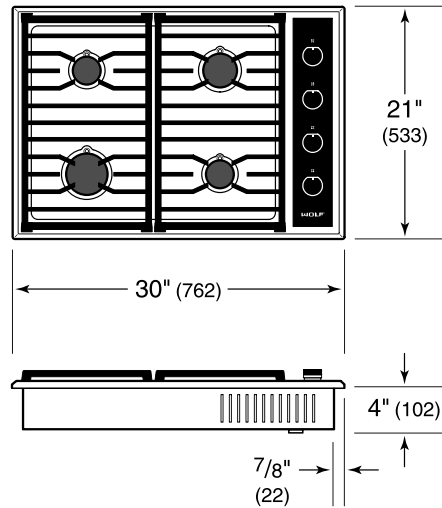

STANDARD INSTALLATION

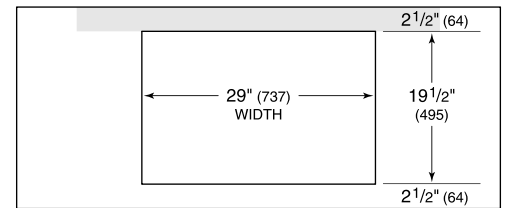

COUNTERTOP CUT-OUT

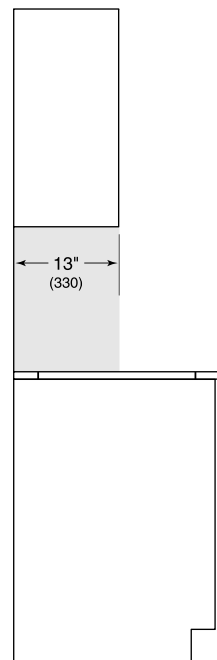

SIDE VIEW

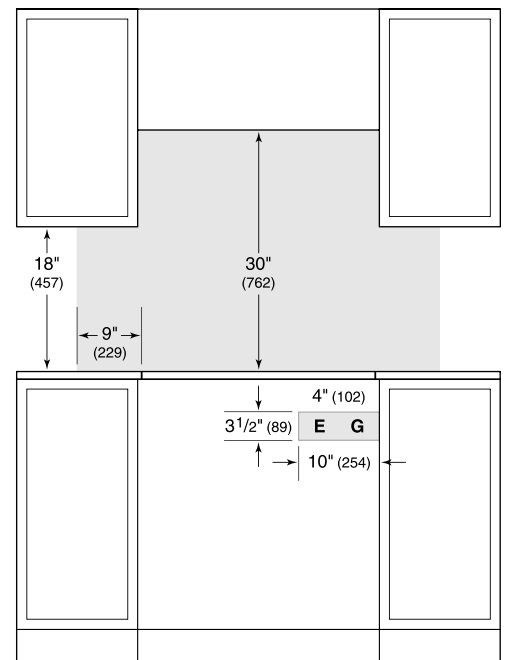

FRONT VIEW

NOTE: Shaded area above countertop indicates minimum clearance to combustible surfaces, combustible materials cannot be located within this area. Electrical and gas supply location only applies to installations with built-in oven.