

**JDH/C2 Series** Equipped with halogen lighting. Not available with heat lamps. Optional duct covers available in standard and custom sizes.

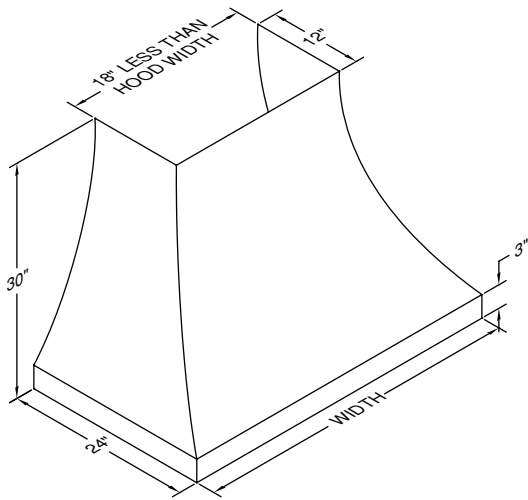

### Recommended Mounting Height

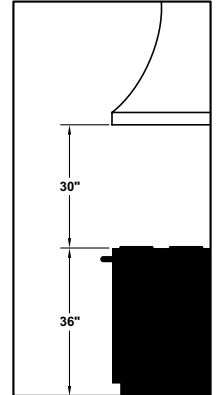

\*Recommended mounting height is for optimum performance.

### Connection Diagrams (36" - 48" Widths)

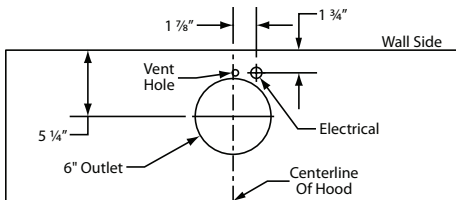

**B100 Single Blower (Top View)**

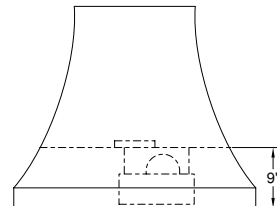

**(Front View)**

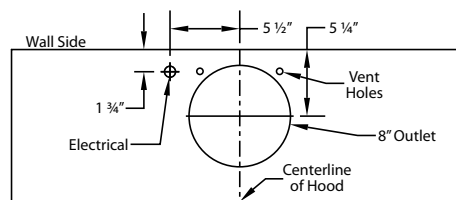

**B200 Dual Blower (Top View)**

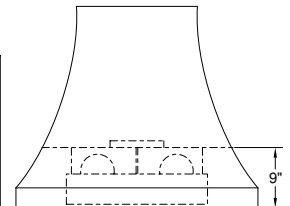

**(Front View)**

### Connection Diagram (48" - 60" Widths)

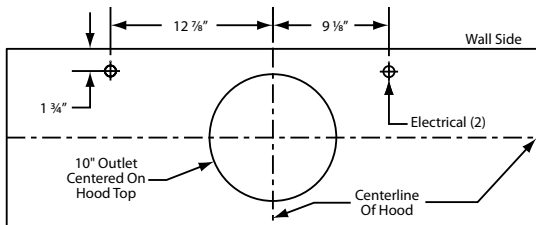

**900 CFM B200 Dual & B100 Single Blower (Top View)**

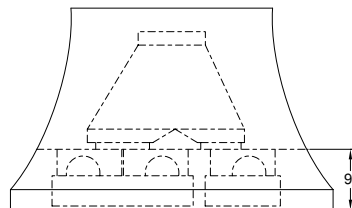

**VP562 Standard Transition Installed (Front View)**

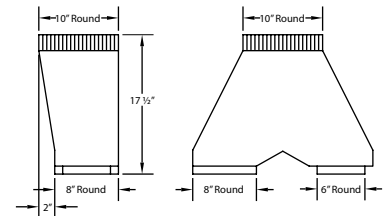

**VP562 Standard Transition Included**

### Connection Diagram (54" - 66" Widths)

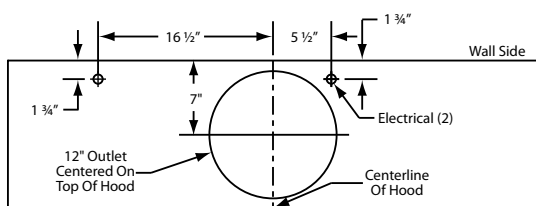

**1200 CFM Double B200 Dual Blowers (Top View)**

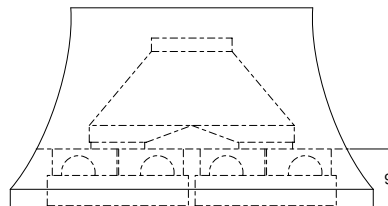

**VP563 Standard Transition Installed (Front View)**

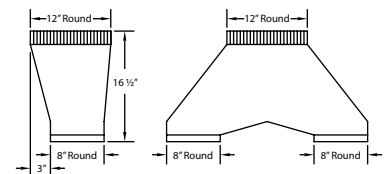

**VP563 Standard Transition Included**

### Electrical/Mechanical Specifications For Blower Units

Model	Volts	Amps*	Hz	RPM	CFM SP@0.0"	Equivalent CFM*	CFM SP@0.1"	CFM SP@0.2"	CFM SP@0.3"	Minimum Round Duct Size	Sones#
B100 Single	115	1.5	60	1550	300	450	273	245	225	6" (28 in. <sup>2</sup> )	5.4
B200 Dual	115	2.9	60	1550	600	900	531	480	430	8" (50 in. <sup>2</sup> )	6.5
B200 Dual & B100 Single	115	4.4	60	1550	900	1350	804	725	655	VP562: 10" (79 in. <sup>2</sup> )	6.3
Two B200 Duals	115	5.8	60	1550	1200	1800	1062	960	860	VP563: 12" (113 in. <sup>2</sup> )	6.6

\* Add 0.5 amp for each halogen light. Hoods are available with halogen lights (2 lights: 30" - 41", 3 lights: 42" - 53", 4 lights: 54" - 66").

# Because the Magic Lung® blower uses centrifugal filtration rather than conventional baffle or mesh filters, the Magic Lung® blower can handle cooking equipment with higher cubic feet per minute (CFM) requirements and can deliver equivalent CFM much more efficiently than other filtration systems. When comparing the Magic Lung® with other blower units made by other manufacturers, use the "Equivalent CFM".

# Ratings in accordance with the Standard Test Code by the Energy Systems Laboratory of the Texas Engineering Experiment Station.