

## SuperSteam+™ Oven

MODEL  
SSC3088AS



SuperSteam+™  
Oven: Model SSC3088AS

<b>CUSTOMER ASSISTANCE .....</b>	<b>2</b>	<b>NEW OVEN CLEAN - BEFORE FIRST USE .....</b>	<b>12</b>
<b>US CONSUMER LIMITED WARRANTY.....</b>	<b>3</b>	<b>COOKING FUNCTIONS .....</b>	<b>13</b>
<b>CANADA CONSUMER LIMITED WARRANTY .....</b>	<b>4</b>	<b>AUTOMATIC COOKING.....</b>	<b>14-16</b>
<b>IMPORTANT SAFETY INSTRUCTIONS.....</b>	<b>5</b>	<b>THE MENUS .....</b>	<b>17-19</b>
<b>INFORMATION YOU NEED TO KNOW.....</b>	<b>6-8</b>	<b>STEAM OPTIONS.....</b>	<b>20</b>
<b>PART NAMES.....</b>	<b>9</b>	<b>MANUAL COOKING.....</b>	<b>21-22</b>
<b>CONTROL .....</b>	<b>10</b>	<b>OTHER FEATURES .....</b>	<b>23</b>
<b>IMPORTANT INSTRUCTIONS.....</b>	<b>11</b>	<b>CLEANING AND CARE .....</b>	<b>24-25</b>
<b>BEFORE OPERATING.....</b>	<b>12</b>	<b>BEFORE YOU CALL FOR SERVICE.....</b>	<b>26</b>

# CUSTOMER ASSISTANCE

---

**IMPORTANT! Register within 10 days of purchase.**

**Register ONLINE at [www.sharppusa.com/productregistration](http://www.sharppusa.com/productregistration)**

To aid in reporting this appliance, please record below the model number and serial number located on the unit. We also suggest you record all the information listed and retain for future reference.

**MODEL NUMBER** \_\_\_\_\_ **SERIAL NUMBER** \_\_\_\_\_

**DATE OF PURCHASE** \_\_\_\_\_ / \_\_\_\_\_ / \_\_\_\_\_

**DEALER** \_\_\_\_\_ **TELEPHONE** \_\_\_\_\_

**SERVICER** \_\_\_\_\_ **TELEPHONE** \_\_\_\_\_

---

## FOR US

---

**TO PHONE:**      **CALL 1-800-BE-SHARP (237-4277) for:**  
                         SERVICE (for your nearest Sharp Authorized Servicer)  
                         PARTS (for your authorized parts distributor)  
                         ADDITIONAL CUSTOMER INFORMATION

**TO WRITE:**  
  
                         Sharp Electronics Corporation  
                         Customer Assistance Center  
                         Sharp Plaza Blvd  
                         Memphis, Tennessee 38193

**TO ACCESS INTERNET: [www.sharppusa.com](http://www.sharppusa.com)**

Please provide the following information when you write or call: model number, serial number, date of purchase, your complete mailing address (including zip code), your daytime telephone number (including area code) and description of the problem.

---

## FOR CANADA

---

To obtain the name and address of the nearest Sharp Authorized Service Centre, please contact:

                         Sharp Electronics Of Canada Ltd.  
                         335 Britannia Road East  
                         Mississauga, Ontario  
                         L4Z 1W9  
                         (905) 568-7140

**TO ACCESS INTERNET: [www.sharpp.ca](http://www.sharpp.ca)**

Please provide the following information when you write or call: model number, serial number, date of purchase, your complete mailing address (including zip or postal code), your daytime telephone number (including area code) and description of the problem.

# SHARP®

## US CONSUMER LIMITED WARRANTY

SHARP ELECTRONICS CORPORATION (“Sharp”) warrants to the first consumer purchaser (“Purchaser”) that this SHARP brand product (“Product”), when shipped in its original container and sold or distributed in the United States by Sharp or an authorized Sharp dealer or reseller, will be free from defective workmanship and materials, and agrees that it will, at its option, either repair the defect or replace the defective Product or part thereof with a new or remanufactured equivalent at no charge to the Purchaser for parts or labor for the period(s) set forth below.

This limited warranty does not apply to any appearance items of the Product nor to the additional excluded item(s) set forth below nor to any Product the exterior of which has been damaged or defaced, which has been subjected to misuse, abnormal service or handling, or which has been altered or modified in design or construction.

In order to enforce the rights under this limited warranty, the Purchaser should follow the steps set forth below and provide proof of purchase to the servicer.

The limited warranty described herein is in addition to whatever implied warranties may be granted to Purchasers by law. ALL IMPLIED WARRANTIES INCLUDING THE WARRANTIES OF MERCHANTABILITY AND FITNESS FOR USE ARE LIMITED TO THE PERIOD(S) FROM THE DATE OF PURCHASE SET FORTH BELOW. Some states do not allow limitations on how long an implied warranty lasts, so the above limitation may not apply to you.

Neither the sales personnel of the seller nor any other person is authorized to make any warranties other than those described herein, or to extend the duration of any warranties beyond the time period described above on behalf of Sharp.

The warranties described herein shall be the sole and exclusive warranties granted by Sharp and shall be the sole and exclusive remedy available to the Purchaser. Correction of defects, in the manner and for the period of time described herein, shall constitute complete fulfillment of all liabilities and responsibilities of Sharp to the Purchaser with respect to the Product, and shall constitute full satisfaction of all claims, whether based on contract, negligence, strict liability or otherwise. In no event shall Sharp be liable, or in any way responsible, for any damages or defects in the Product which were caused by repairs or attempted repairs performed by anyone other than an authorized servicer. Nor shall Sharp be liable or in any way responsible for any incident or consequential economic or property damage. Some states do not allow the exclusion of incidental or consequential damages, so the above exclusion may not apply to you.

THIS LIMITED WARRANTY GIVES YOU SPECIFIC LEGAL RIGHTS. YOU MAY ALSO HAVE OTHER RIGHTS WHICH VARY FROM STATE TO STATE.

THIS LIMITED WARRANTY IS VALID ONLY IN THE FIFTY (50) UNITED STATES, THE DISTRICT OF COLUMBIA AND PUERTO RICO.

**Your product model number & description** Model # SSC3088AS or Home Use SuperSteam+. (Be sure to have this information available when you need service for your Product.)

**Warranty period for this product:** One (1) year parts and labor including in-home service.

**Additional item(s) excluded from warranty coverage (if any):** Non-functional accessories and light bulbs.

**Where to obtain service:** From a Sharp Authorized Servicer located in the United States. To find the location of the nearest Sharp Authorized Servicer, call Sharp toll free at 1-800-BE-SHARP (1-800-237-4277).

**What to do to obtain service:** In-home service is provided for one year from date of purchase. In-home service can be arranged by calling 1-800-BE-SHARP. Be sure to have Proof of Purchase available.

---

TO OBTAIN SUPPLY, ACCESSORY OR PRODUCT INFORMATION, CALL 1-800-BE-SHARP or visit [www.sharpsusa.com](http://www.sharpsusa.com). SAVE THE PROOF OF PURCHASE AS IT IS NEEDED SHOULD YOUR OVEN EVER REQUIRE WARRANTY SERVICE.



**CANADA CONSUMER LIMITED WARRANTY**  
**Congratulations on your purchase!**

Sharp Electronics of Canada Ltd. ("Sharp") warrants to the first purchaser for this Sharp brand product ("Product"), when shipped in its original container and sold or distributed in Canada by Sharp or by an authorized Sharp dealer, and Product was not sold "as is" or "sales final" that the Product will during the applicable warranty period, be free from defects in material and workmanship, and will within the applicable warranty period, either repair the defective Product or provide the first purchaser a replacement of the defective Product.

This warranty does not apply to any appearance items of the product nor to the additional excluded item(s) set forth below nor to any product the exterior of which has been damaged or defaced, which has been subjected to improper voltage or other misuse, abnormal service or handling, which has been altered or modified in design or construction, or if the serial number or model number affixed to Product has been removed, defaced, changed, altered or tampered with.

**How to get service:** Should this Sharp product fail to operate during the warranty period, warranty service is provided by an Authorized Sharp Service Centre or an Authorized Sharp Servicing Dealer. In home warranty service will be carried out to locations accessible by on-road service vehicle and within 50 km of an authorized Sharp service centre. The servicer may if necessary take the unit for repair at the servicer's facility. No other person (including any Sharp dealer or service centre) is authorized to extend, enlarge or transfer this warranty on behalf of Sharp.

The express warranties in this limited warranty are, except for consumer purchasers domiciled in Quebec, in lieu of and, except to the extent prohibited by applicable law, Sharp disclaims all other warranties and conditions, express or implied, whether arising by law, statute, by course of dealing or usage of trade, including, without limitation, implied warranties or conditions of merchantability and/or quality, fitness for a particular use or purpose, and/or non-infringement. Limitations (not applicable to consumer purchasers domiciled in Quebec to the extent prohibited under Quebec law): (a) Sharp shall not be liable for any incidental, special, consequential, economic, exemplary or indirect damages of any kind or nature (including lost profits or damages for loss of time or loss of use or loss of data) arising from or in any connection with the use or performance of a Product or a failure of a Product, even if Sharp is aware of or has been advised of the possibility of such damages; (b) the remedies described in this limited warranty constitute complete fulfillment of all obligations and responsibilities of Sharp to the purchaser with respect to the Product and shall constitute full satisfaction of all claims, whether based on contract, negligence, strict liability or otherwise. Some provinces may not allow the exclusion or limitation of certain damages, or limits on the duration or voiding of implied warranties or conditions; in such provinces, the exclusions and limits herein may not apply. This limited warranty is, except for consumer purchasers domiciled in Quebec, governed by the laws of the Province in Canada in which the purchaser has purchased the Product. For consumer purchasers domiciled in Quebec this limited warranty is governed by the laws of Quebec.

<b>Your product model number &amp; description</b>	Model # SSC3088AS Home Use SuperSteam+ Oven. (Be sure to have this information available when you need service for your product).
<b>Warranty period for this product:</b>	One (1) year parts and labor including in-home service.
<b>Additional item(s) excluded from warranty coverage (if any):</b>	Non-functional accessories, reservoir, drip tray, base tray, rack, baking tray, perforated tray and light bulb.

To obtain the name and address of the nearest Authorized Sharp Service Centre or Dealer, please contact:

SHARP ELECTRONICS OF CANADA LTD  
335 Britannia Road East  
Mississauga, Ontario  
L4Z 1W9  
(905) 568-7140  
Website: [www.sharp.ca](http://www.sharp.ca)

**THIS LIMITED WARRANTY IS VALID ONLY IN CANADA**

# IMPORTANT SAFETY INSTRUCTIONS

## READ ALL INSTRUCTIONS BEFORE USING

When using the appliance, basic safety precautions should be followed, including the following:

**WARNING** To reduce the risk of burns, electric shock, fire, injury to persons:

- 1 Read all instructions before using the appliance.
- 2 Be sure your appliance is properly installed and grounded by a qualified technician in accordance with the provided Installation Manual.
- 3 Never use your appliance for warming or heating the room.
- 4 Children should not be left alone or unattended in area where appliance is in use. They should never be allowed to sit or stand on any part of the appliance.
- 5 Wear proper apparel. Loose-fitting or hanging garments should never be worn while using the appliance.
- 6 Do not repair or replace any part of the appliance unless specifically recommended in the manual. All other servicing should be referred to a qualified technician.
- 7 Flammable materials should not be stored in an oven or near surface units.
- 8 **DO NOT USE WATER ON GREASE FIRES!** Smother fire or flame or use dry chemical or foam-type extinguisher.
- 9 Use only dry potholders. Moist or damp potholders on hot surfaces may result in burns from steam. Do not let potholder touch hot heating elements. Do not use a towel or other bulky cloth.
- 10 Use care when opening door. Let hot air or steam escape before removing or replacing food.
- 11 Do not heat unopened food containers. Build-up of pressure may cause container to burst and result in injury.
- 12 Keep oven vent ducts and all other openings on the appliance unobstructed.
- 13 Always place oven racks in desired location while oven is cool. If rack must be moved while oven is hot, do not let potholder contact hot heating element in oven.
- 14 Use this appliance only for its intended use as described in this manual. Do not use corrosive chemicals or vapors in this appliance. This appliance is specifically designed to heat, cook or dry food. It is not designed for industrial or laboratory use.
- 15 Do not operate this appliance if it has a damaged cord or plug, if it is not working properly or if it has been damaged or dropped.
- 16 Do not store or use this appliance outdoors. Do not use this product near water—for example, near a kitchen sink, in a wet basement, near a swimming pool or similar locations.
- 17 Do not immerse cord or plug in water.
- 18 Keep cord away from heated surfaces.
- 19 Do not climb or sit on the appliance.
- 20 Keep fingers and other objects and materials away from the door of the appliance when closing.
- 21 When cleaning appliance use only mild, nonabrasive soaps or detergents applied with a sponge or soft cloth. See cleaning instructions on pages 24-25.
- 22 To reduce the risk of fire in the appliance cavity:
  - a Do not overcook food. Carefully attend appliance when paper, plastic or other combustible materials are placed inside the appliance to facilitate cooking.
  - b Remove wire twist-ties from paper or plastic bags before placing bag in appliance.
  - c Do not use the appliance for storage purposes. Do not leave paper products, cooking utensils, or food in the appliance when not in use.
- 23 If the appliance light fails, consult a SHARP AUTHORIZED SERVICER.

**WARNING** As a safety precaution, the oven will periodically exhaust steam during cooking modes to reduce the amount of steam build up in the cavity. The steam will exhaust from the vent above the door pictured.

**CAUTION** Stand clear and do not block vent during steam exhaustion. Steam will be hot.

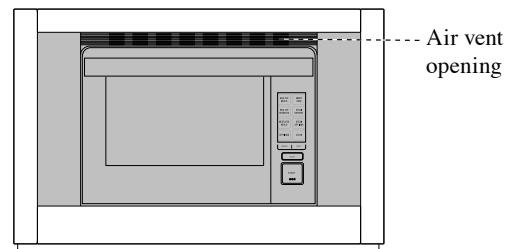

## SAVE THESE INSTRUCTIONS

# INFORMATION YOU NEED TO KNOW

## ABOUT UNPACKING AND EXAMINING YOUR OVEN

- 1 Remove all packing materials from inside the oven.
- 2 Remove the feature sticker, if there is one. Check the oven for any damage, such as misaligned or bent oven, damaged oven seals and sealing surfaces, broken or loose door hinges and latches and dents inside the cavity or on the front side of the oven. If there is any damage, do not operate the oven and contact your dealer or a SHARP AUTHORIZED SERVICER.
- 3 Install or locate this appliance only in accordance with the provided Installation Manual.

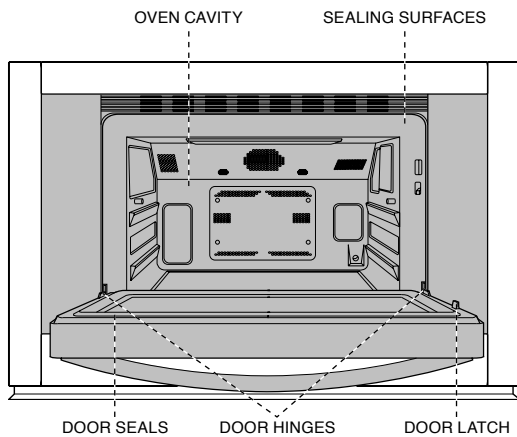

## CHOOSING A LOCATION FOR YOUR OVEN

You will use your oven frequently, so plan its location for ease of use. Your oven can be built into a cabinet or wall by itself, or above any electric wall oven, above Sharp's Microwave Drawer model SMD3070AS or above other Sharp Microwave Drawer models that specify the combination of this oven. It cannot be built in above any gas wall oven.

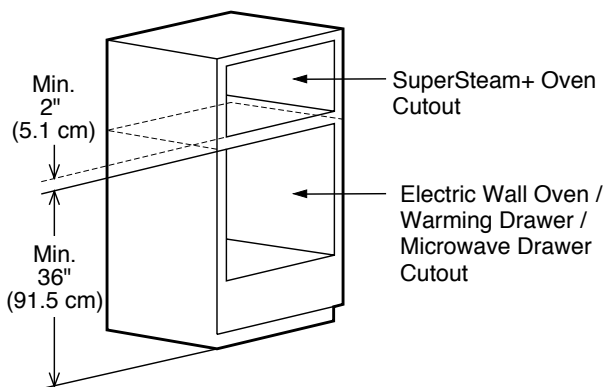

# GROUNDING INSTRUCTIONS

This appliance must be grounded. The oven is equipped with a cord having a grounding wire with a grounding plug. It must be plugged into a wall receptacle that is properly installed and grounded in accordance with the National Electrical Code

### Permanent and Correct Installation

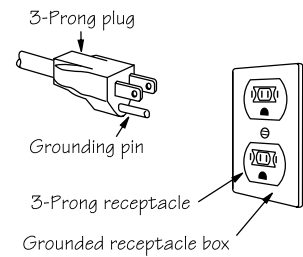

and local codes and ordinances. In the event of an electrical short circuit, grounding reduces risk of electric shock by providing an escape wire for the electric current.

**⚠️ WARNING** – Improper use of the grounding plug can result in a risk of electric shock. **Do not use an extension cord. If the power supply cord is too short, have a qualified electrician or serviceman install an outlet near the appliance.**

If you have any questions about the grounding or electrical instructions, consult a qualified electrician or service person.

## ABOUT SAFETY

- Check foods to see that they are cooked to the United States Department of Agriculture's recommended temperatures.

160°F / 71°C - For fresh pork, ground meat, boneless white poultry, fish, seafood, egg dishes and frozen prepared food.

165°F / 74°C - For leftover, ready-to-reheat refrigerated; deli and carry-out "fresh" food.

170°F / 77°C - White meat of poultry.

180°F / 82°C - Dark meat of poultry.

To test for doneness, insert a meat thermometer in a thick or dense area away from fat or bone.

- Accessible parts (e.g. oven door, oven cavity, dishes and accessories) may become hot during use. Use dry pot holders or oven mitts when removing container, food and oven accessories from the oven and be careful not to touch the oven cavity to prevent burns.
- Use care when opening door. Avoid steam burns by directing steam away from the face and hands. Always stand back from the oven when opening it.
- Slowly lift the farthest edge of a dish's covering and oven cooking bags away from the face.
- Stay near the oven while it's in use and check cooking progress frequently so that there is no chance of overcooking food.
- NEVER use the cavity for storing cookbooks or other items.

# INFORMATION YOU NEED TO KNOW

- Select, store and handle food carefully to preserve its high quality and minimize the spread of foodborne bacteria.
- Use care when removing items from the oven so that the utensil, your clothes or accessories do not touch the door projection.
- Do not touch around the oven light. This area will become hot when the oven light is on.
- To avoid burns, always be careful of splashing grease from the baking tray when removing roasted or broiled meats from the oven.
- To avoid burns, always test food and container temperature and stir before serving. Pay special attention to the temperature of containers, foods and drinks. Do not drink beverage or soup without checking the container's temperature.
- Do not touch the oven door, outer cabinet, rear cabinet, oven cavity, ventilation openings, accessories, dishes and the escaping steam from the air vent openings during operation because they will become hot.
- Do not operate the oven if reservoir cracks and water leaks. Call a Sharp Authorized Service Centre to purchase a replacement part.
- After use, condensed water may be inside oven cavity, especially on the oven floor. Dry any liquid residue with a sponge and wipe out to keep the oven clean.
- Do not move the oven during the operation. If the oven needs to be moved, always drain all water inside the oven using the DRAIN WATER function (See page 25). After draining, empty the drip tray.
- To prevent condensation, which could corrode the appliance, do not leave cooked food in the oven for an extended period.
- Clean the oven at regular intervals and remove any food deposits in the oven or on the door.
- Do not use for deep frying.
- ALWAYS use potholders to prevent burns when handling utensils that are in contact with hot food. Enough heat from the food can transfer through utensils to cause skin burns. In Supersteam, Steam and Convection modes, cabinet, interior and door may be too hot to touch.
- Do not pour cold water on the tempered glass oven floor after cooking as it might break.
- Do not pour cold water on the door as it might break.
- Do not touch hot surfaces.
- The use of accessory attachments not recommended by the appliance manufacturer may cause injuries.
- The oven should not be left unattended during operation. Oven temperatures that are too high or cooking times that are too long may overheat foods resulting in a fire.
- Do not insert fingers or objects in the steam outlets or air vent openings. This may damage the oven and cause an electric shock or a hazard.
- If any objects drop inside the air vent openings, turn off the oven immediately, unplug and consult a Sharp Authorized Servicer.
- Do not touch the plug with wet hands when inserting or removing from the outlet. Plug securely into the electric wall receptacle and remove by gripping on the plug end. Never pull using just the cord.
- During steaming, steam may come from the right side of the vent.
- In the case of a grease fire, DO NOT USE WATER. Smother fire or flame or use dry chemical or foam-type extinguisher.
- Never use your appliance for warming or heating the room.
- Loose-fitting or hanging garments should never be worn while using the appliance.
- Do not heat unopened food containers. Build-up of pressure may cause container to burst and result in injury.
- Always place oven racks in desired location while oven is cool. If rack must be moved while oven is hot, do not let potholder contact hot heating element in oven.

## ABOUT CHILDREN

Children below the age of 7 should use the oven with a supervising person very near to them. Between the ages of 7 and 12, the supervising person should be in the same room.

The child must be able to reach the oven comfortably; if not, he/she should stand on a sturdy stool.

At no time should anyone be allowed to lean or swing on the oven door.

Children should be taught all safety precautions.

Don't assume that because a child has mastered one cooking skill he/she can cook everything.

Children need to learn that the oven is not a toy. Young children should be supervised to ensure that they do not play with the oven.

Children should not be left alone or unattended in area where appliance is in use. They should never be allowed to sit or stand on any part of the appliance.

# INFORMATION YOU NEED TO KNOW

## ABOUT UTENSILS AND COVERINGS

The chart below will help you decide what utensils and coverings should be used in each mode.

UTENSILS - COVERINGS	COOKING MODE	
	SUPERHEATED STEAM (STEAM ROAST & STEAM GRILL) / CONVECTION	STEAM
Aluminium Foil, Foil Containers	YES	YES
Metal	YES	YES
China, Ceramics, Porcelain, Pottery, Stoneware	YES	YES
Heat-resistant Glassware e.g. Pyrex®	YES	YES
	Care should be taken if using fine glassware as it can break or crack if heated suddenly.	
Non-heat-resistant Glassware	NO	NO
Heat-resistant Plastic/Polystyrene	NO	YES
	Check manufacturer's temperature range.	Care must be taken as some containers warp, melt or discolor at high temperatures.
Plastic, Thermoset®	NO	YES
Microwave Plastic Wrap	NO	NO
Paper Towels, Paper Plates	NO	NO
Parchment Paper	NO	YES
Wax Paper	NO	NO
Roasting Rack	YES	NO
Roasting Bags	YES	NO
	Roasting bags should only be used with convection bake or roast.	
Silver Dishes and Cooking Utensils or Containers that might rust inside the oven.	NO	NO
Low Rack, High Rack, Baking Tray, Steam Basket	YES	YES
Silicone-based cookware	NO	NO

## ACCESSORIES

There are many heat-resistant accessories available for purchase. Evaluate carefully before you purchase so that they meet your needs. Sharp is not responsible for any damage to the oven when accessories are used.

For automatic cooking, use the recommended container in the cooking chart in this operation manual.



# PART NAMES

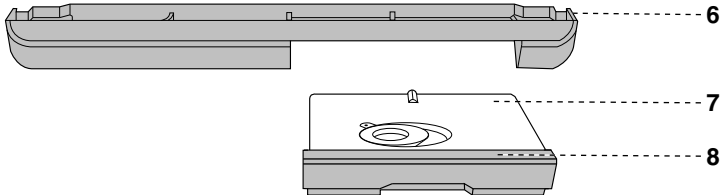
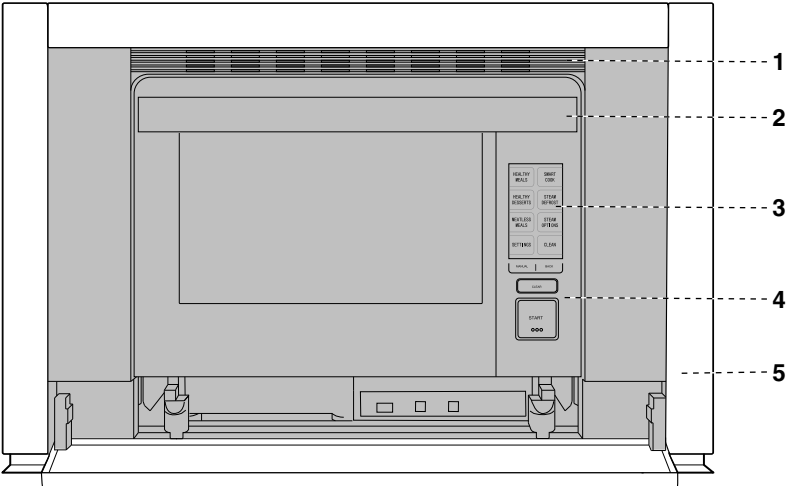

- 1 Air vent opening
- 2 Handle
- 3 LCD display
- 4 Control panel
- 5 Frame
- 6 Drip tray (see page 11)
- 7 Reservoir lid (see page 11)
- 8 Reservoir (see page 11)
- 9 Oven light
- 10 Anti-tip stubs
- 11 Tray guide
- 12 Upper level
- 13 Lower level
- 14 Door hinges
- 15 Latches
- 16 Air deflector
- 17 Ceramic oven floor
- 18 Door gasket

## ACCESSORIES

- 19 2 Trays
- 20 2 Racks

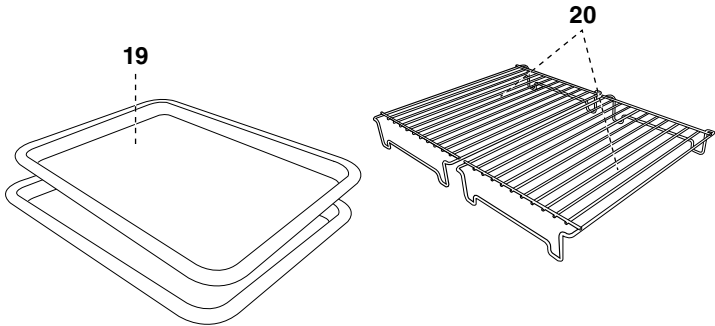
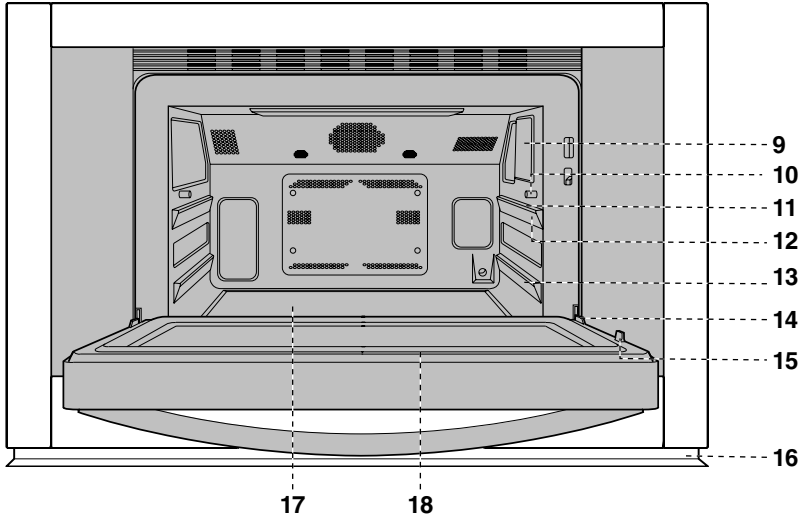

# CONTROL

HOME PAGE

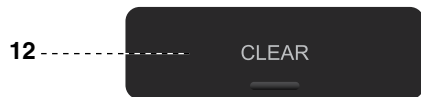
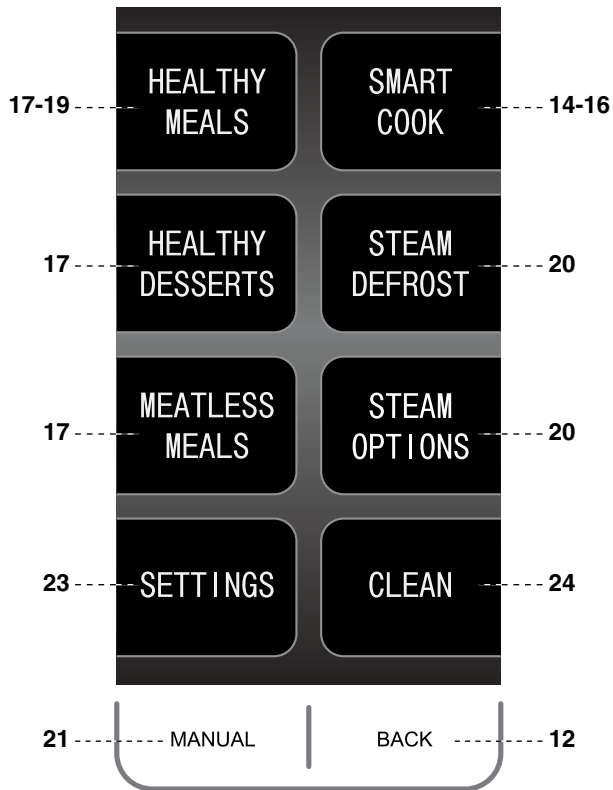

MANUAL PAGE

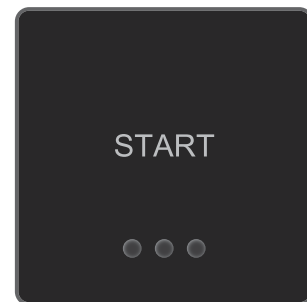
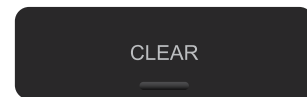
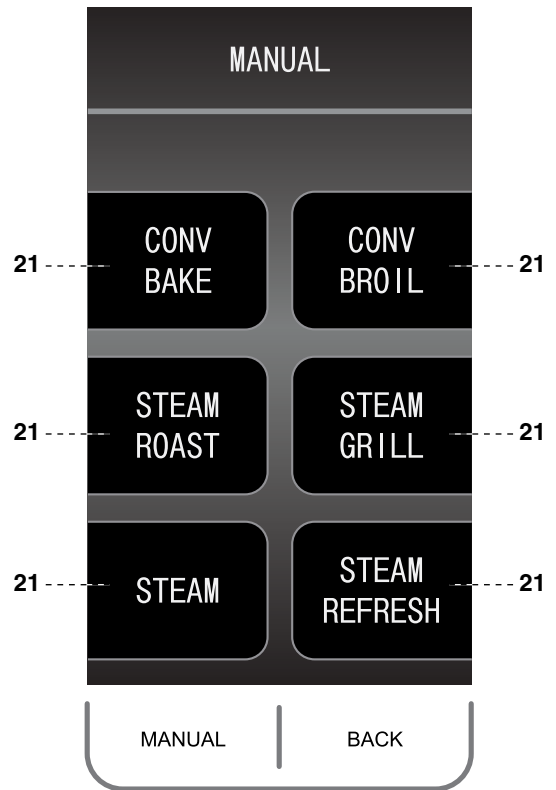

# IMPORTANT INSTRUCTIONS

## READ CAREFULLY BEFORE COOKING

### RESERVOIR

Filling the reservoir with fresh cold tap water is necessary for all Steam functions in both Automatic and Manual Cooking. Follow the directions below before cooking.

- 1 Pull the reservoir toward you to remove.
- 2 Wash the reservoir and lid for first time use.
- 3 Fill the reservoir with fresh cold tap water through the lid to the 2 mark each time you begin to cook. Do not fill the reservoir over the 2 mark.
- 4 Close the lid tightly.
- 5 Reinstall the reservoir, pushing it firmly into place.
- 6 After cooking, empty the reservoir and wash the reservoir and the lid.

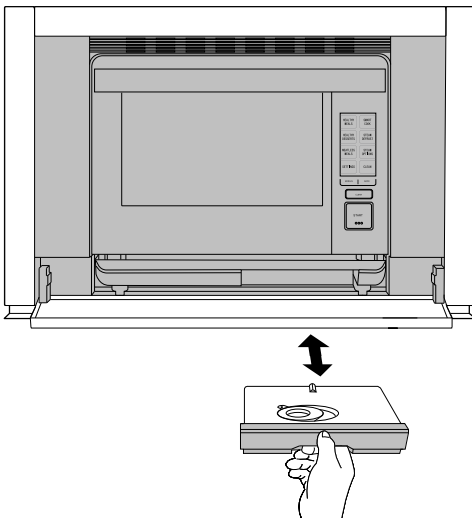

### NOTES:

- 1 Do not use distilled water or any other liquid.
- 2 An insufficient amount of water in the reservoir may cause an undesired result.
- 3 We recommend that you empty the reservoir every time after cooking. Do not leave the reservoir filled with water in the oven over a day.
- 4 If any messages, such as “Fill water reservoir”, show in the display during cooking, remove reservoir and refill water.
- 5 Do not drop or damage the reservoir. Heat may cause the reservoir to change shape. Do not use a damaged reservoir. Call a Sharp Authorized Service Centre to purchase a replacement part.
- 6 There may be a few water drops when removing the reservoir. Wipe the oven dry with a soft cloth.
- 7 Do not block the air holes on the lid of the reservoir. It will cause trouble during cooking.
- 8 A small amount of water will drain into the drip tray when the reservoir is removed. Empty after cooking.

### DRIP TRAY

**The drip tray must be in the correct position while cooking. For proper operation, follow the directions below.**

The drip tray is packed with the oven. Place the drip tray under the oven door as shown below. This drip tray collects the condensation from the oven door.

**To remove the drip tray:** Pull the drip tray toward you with both hands. Water should not be dripping before removing the drip tray.

**To replace the drip tray:** Place the drip tray onto the right and left hooks under the oven and push firmly as shown below.

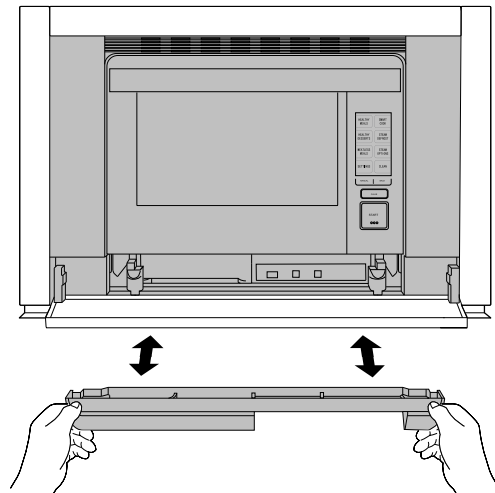

If “Replace drip tray” or “Empty drip tray and replace” is shown in the display, remove and replace the drip tray correctly.

**Empty the drip tray after each time you cook.** Empty, rinse thoroughly, dry and replace. Cooking repeatedly without emptying the drip tray may cause it to overflow.

### ⚠ WARNING

- 1 The oven will become very hot after cooking and draining water function.
- 2 Do not open the oven with your face close to the oven. Steam from the oven may cause burns.
- 3 Wait until the oven has cooled before emptying the reservoir and the drip tray. Then, wipe the oven cavity.
- 4 Do not touch the water directly as water in the drip tray may be hot.

# BEFORE OPERATING

---

Before operating your new oven, read and understand this operation manual completely.

Before the oven can be used, follow these steps:

- 1 Place the drip tray correctly. See page 11.
- 2 Close the door. Plug in the oven. Check that the display lights.
- 3 Follow directions below to clean the oven before first use.

## STANDBY POWER

To activate the oven, open and close door.

The U.S. Department of Energy has set forth standards for standby power and energy consumption in appliances during periods of nonuse. In order to comply with these requirements, the display on this unit will not be visible or active in initial use or in periods of inactivity. This unit's display will need to be activated by the action of opening and closing the door. Once the opening and closing of the door has been performed, the display will be fully visible and operational.

# NEW OVEN CLEAN - BEFORE FIRST USE

---

The steam generator heats the water which is used for cooking. It should be cleaned before the first use to get rid of any odor in the oven cavity. Clean the oven with New Oven Clean in manual operation for 20 minutes without preheat and food. You may notice some smoke and odor during this process. This is normal. The oven is not out of order.

## PREPARATION

- 1 Ventilate the room.
- 2 Fill the reservoir with fresh cold tap water and install.
- 3 Install the empty drip tray.

## CLEAR

Press the CLEAR pad to:

- 1 Return to Home Page.
- 2 Cancel a program during cooking.

## BACK

Press Back if you want to go back to the previous page during programming before pressing START. After pressing START, it is not possible to return to a previous page.

## TO CLEAN THE OVEN BEFORE USE, FOLLOW THESE STEPS.

- 1 Select CLEAN from the home page.
- 2 Select NEW OVEN CLEAN from the list provided.
- 3 Insert all accessories (i.e. two trays, two racks) into the oven.
- 4 Fill the reservoir with fresh cold water. Replace reservoir and press START.
- 5 Once NEW OVEN CLEAN is complete, use caution in opening the oven.

## WARNING

- 1 The oven door, outer cabinet and oven cavity will become hot.
- 2 Do not open the oven with your face close to the oven. Steam from the oven may cause burns.

# COOKING FUNCTIONS

The SuperSteam+ oven encompasses multiple cooking functions to allow for flexibility and high performance for the best results. The array of functions range from traditional dry heat convection cooking to steam to superheated steam that provides moisture and browning in tandem. Please see below for the categories and capabilities of this unique oven.

There are 3 categories.

**1** Dry heat : Convection Bake, Convection Broil

**2** Superheated steam : Steam Roast, Steam Grill

**3** Steam

Note : See additional Steam options on page 20.

1

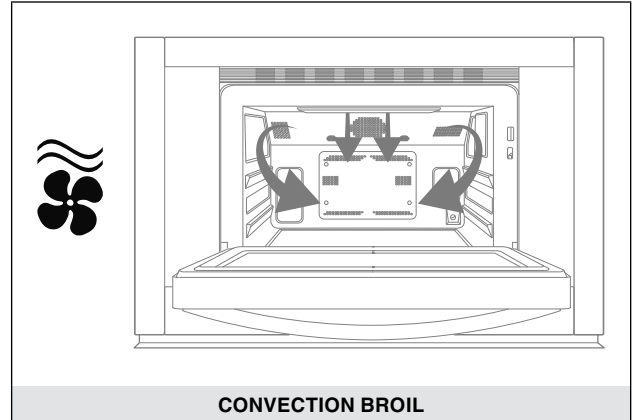
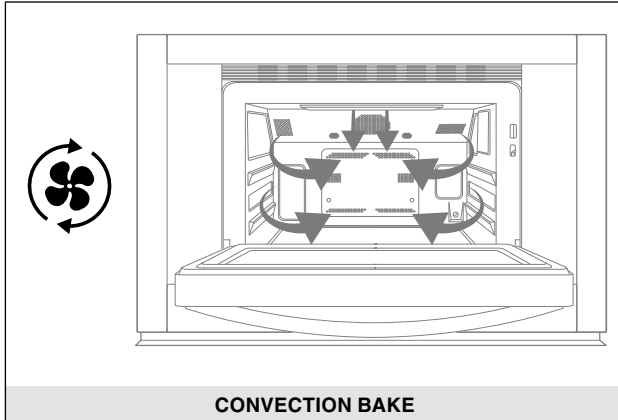

2

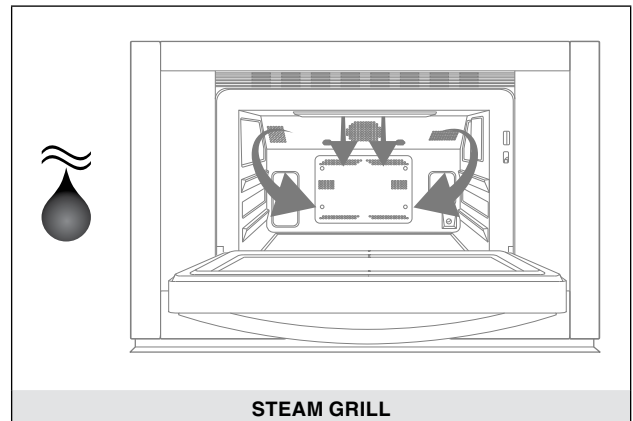
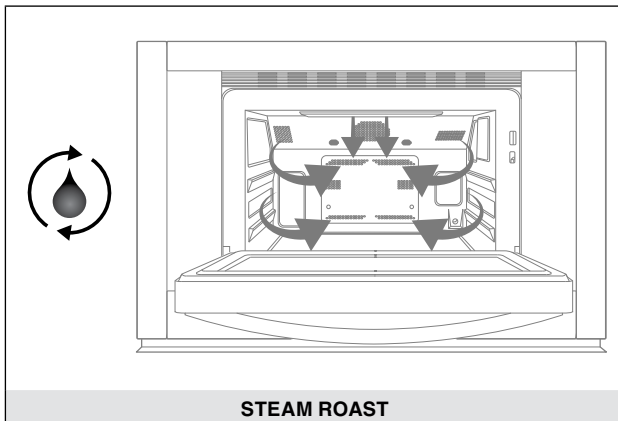

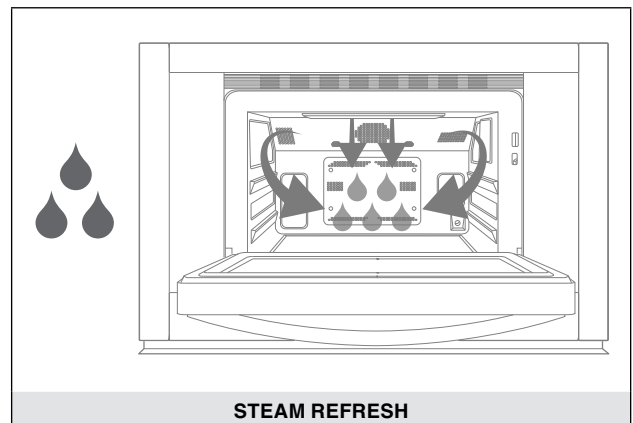
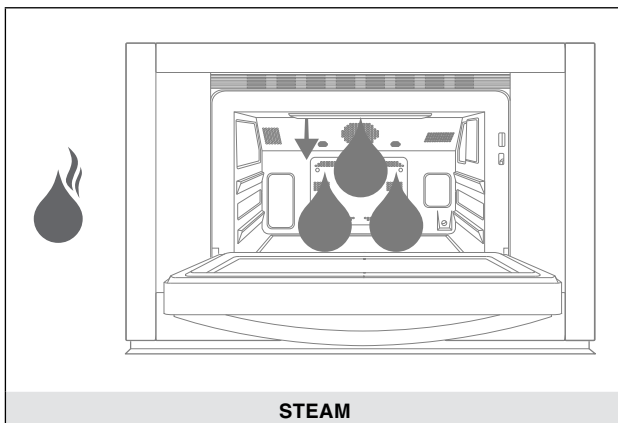

3



# AUTOMATIC COOKING

The menus included in the automatic cooking options include suggested amounts and average cooking times. Please note that different brands of food items can vary in shape, size, quantity, and weight. Please be sure to monitor the food items during cooking to ensure satisfactory completion of the selected automatic menu item.

HOME PAGE	COOKING OPTIONS	MENUS	SUGGESTED AMOUNT	PRE-SET TIME COOK
SMART COOK	CONVEC BAKE 	1. Bread		
		• Biscuit	8 - 16	12 mins.
		• Muffin	12	20 mins.
		• Crescent Roll	8 - 16	14 mins.
		• Dinner Roll	1 pan or 6 - 8 large rolls	20 mins.
		2. Desserts		
		• Cookies	12 - 24	12 mins.
		• Brownies	1 pan	40 mins.
		• Layer Cake	1 - 2 pans	27 mins.
		• Pre-Made Pie	1 pie	45 mins.
		3. Snacks		
		• Fish Sticks	25	25 mins.
		• Chicken Nuggets	25	15 mins.
		• French fries	75	30 mins.
		• Tater Tots	60	20 mins.
		4. Pizza		
	• Personal Pizza	1	15 mins.	
	• Thin Crust Pizza	1	15 mins.	
	• Thick Crust Pizza	1	20 mins.	
	• Fresh Pizza	1	20 mins.	
	STEAM GRILL 	1. Beef		
		• Beef Fillet	2	13 mins.
		• T-Bone	2	15 mins.
		• Beef Sirloin	2	10 mins.
		• Hamburger	4	14 mins.
		2. Fish		
		• Tuna Steak	2	10 mins.
		• Salmon	4	7 mins.
• Sea Scallops		14	8 mins.	
• Jumbo Shrimp		20	5 mins.	
3. Pork				
• Pork Chop		4	12 mins.	
• Bratwurst	4	8 mins.		
• Ham Slice	2	12 mins.		
• Bacon	6	10 mins.		
4. Poultry				
• Boneless Chicken Breast Halves	2	20 mins.		
• Chicken Pieces	6	9 mins.		

# AUTOMATIC COOKING

HOME PAGE	COOKING OPTIONS	MENUS	SUGGESTED AMOUNT	PRE-SET TIME COOK
SMART COOK	STEAM ROAST 	1. Beef		
		• Eye of Round Roast	1	50 mins.
		• Meat Loaf	1	40 mins.
		• Rib Roast	1	30 mins.
		• Tenderloin	1	50 mins.
		2. Pork		
		• Boneless Ham	1	30 mins.
		• Boneless Pork Loin Roast	1	1 hr.
		• Pork Tenderloin	1	1 hr.
		3. Poultry		
		• Cornish Hen	2	35 mins.
		• Turkey Breast, Half	2	27 mins.
		• Whole Chicken	1	55 mins.
		• Chicken Pieces	6	9 mins.
		4. Potatoes		
		• Sweet Potato	4	30 mins.
	• Yam	2	40 mins.	
	• Baked Potato	2	50 mins.	
	• New Potato	13	25 mins.	
	STEAM 	1. Eggs		
		• Poached Eggs	4	8 mins.
		• Hard Boiled Eggs	7	15 mins.
		2. Fish		
		• Salmon Fillet	4	15 mins.
• Tilapia		4	10 mins.	
• Whitefish		2	12 mins.	
3. Shellfish				
• Clam in Shell		10	15 mins.	
• Lobster		3	20 mins.	
• Sea Scallops		14	10 mins.	
• Shrimp		20	10 mins.	
4. Vegetables Fresh				
• Asparagus		30	8 mins.	
• Broccoli		3 servings	8 mins.	
• Green Beans		3 servings	8 mins.	
• Squash		2 servings	10 mins.	

# AUTOMATIC COOKING

## SMART COOK

- To automatically cook biscuits in Smart Cook:

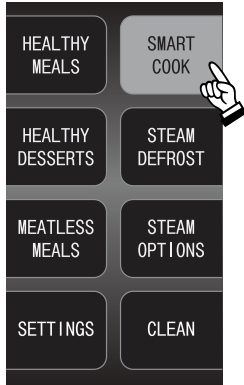

1. Press SMART COOK.

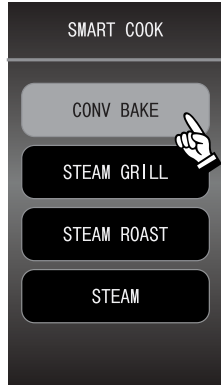

2. Press CONV BAKE.

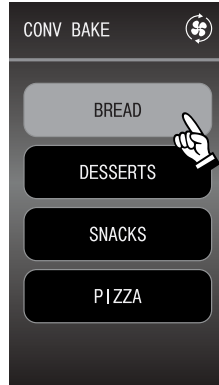

3. Press BREAD.

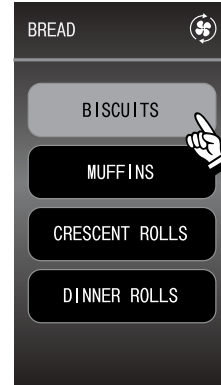

4. Press BISCUITS.

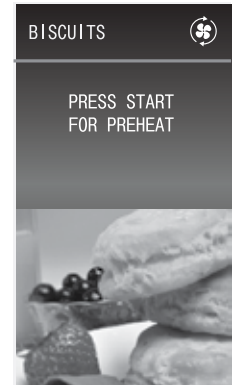

5. Press START.

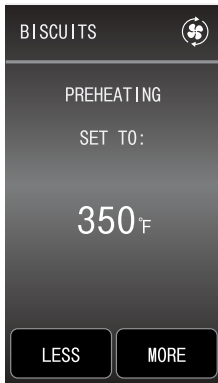

6. PREHEAT starts.

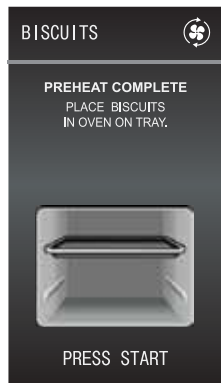

7. When PREHEAT completes, place up to 8 biscuits in pan on upper level. Press START.

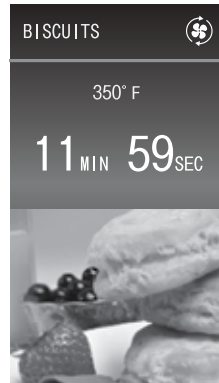

8. Cooking time counts down.



9. Finished cooking.

Option for more cooking time:

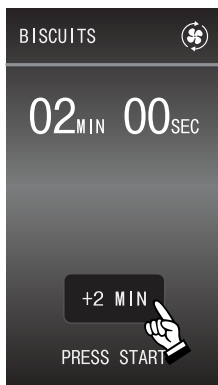

10. Press +2 MIN to add 2 minutes.

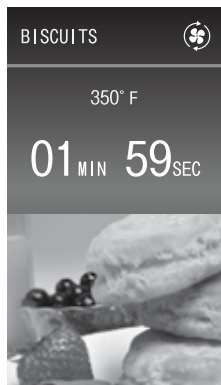

11. Cooking time counts down.



12. Finished cooking.



# THE MENUS

HOME PAGE	MENU OPTIONS	MENUS	SERVING SIZE	PRE-SET TIME COOK
HEALTHY MEALS	LOW CARB MENU	1. Basil Chicken Kabobs	6	7 mins
		2. Salmon with Dilled Tomatoes	4	15 mins
		3. Italian Stuffed Peppers	6	20 mins
		4. Pesto Broiled Fish	4	14 mins
	LOW SODIUM MENU	1. Marvelous Meat Loaf	8	50 mins
		2. Baked Curried Salmon	4	15 mins
		3. Apricot Glazed Pork Chops	4	17 mins
		4. Herbed Fish Steaks	4	18 mins
	FAMILY MEALS	1. Herbed Roasted Chicken	6	55 mins
		2. Crustless Chicken Quiche	6	40 mins
		3. Cajun Burgers	4	12 mins
		4. Zesty Pork Loin	9	50 mins
	MEALS FOR 2	1. Salmon	2	15 mins
		2. Fajitas	2	15 mins
		3. Pork	2	15 mins
		4. Chicken	2	15 mins
HEALTHY DESSERTS	1. Apple Berry Pie	8	25 mins	
	2. Chocolate Chip Zucchini Cake	9	35 mins	
	3. Pineapple-Orange Upside Down Cake	8	20 mins	
	4. Banana Apricot Bran Bread	12	50 mins	
MEATLESS MEALS	VEGAN	1. Korean BBQ Tofu Tacos	5	8 mins
		2. Sweet Potato Black Bean Burger	4	27 mins
		3. Stuffed Peppers	4	35 mins
		4. Spaghetti Squash	6	50 mins
	VEGETARIAN	1. Sweet Potato with Ricotta Kale	4	38 mins
		2. Asparagus Mushroom Quiche	8	42 mins
		3. Cuban Bowl	2	25 mins
		4. Spring Roll	6	27 mins

# THE MENUS

## HEALTHY MEALS

- To cook basil chicken kabobs in HEALTHY MEALS:



1. Press **HEALTHY MEALS**.

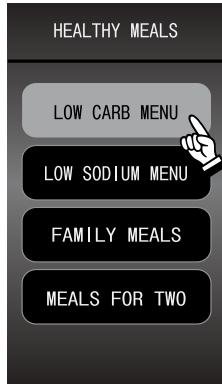

2. Press **LOW CARB MENU**.



3. Press **BASIL CHICKEN KABOBS**.

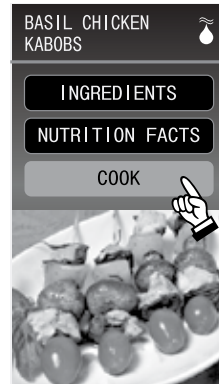

4. Press **COOK**.



5. Press **START** for preheat.

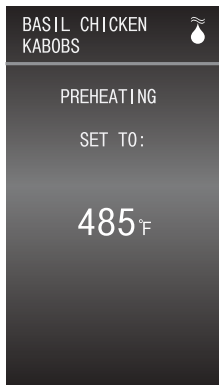

6. Preheating oven.

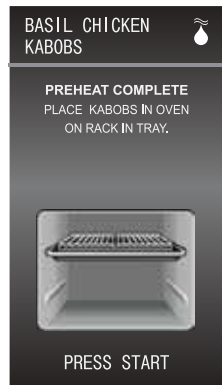

7. Place chicken kabobs in pan on upper level. Press **START**.

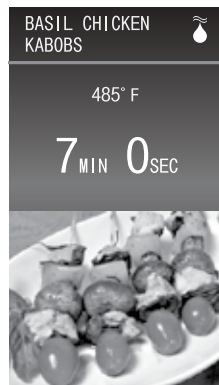

8. Cooking time counts down.

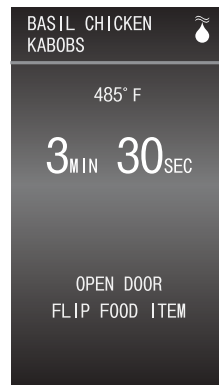

9. When audible sound is on, turn food over.



10. Finished cooking.

## Option for BASIL CHICKEN KABOBS - INGREDIENTS:

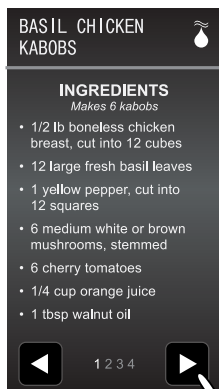

5. At step 4 press **INGREDIENTS**. Press right arrow to continue to next page.



6. Press right arrow to continue to next page.

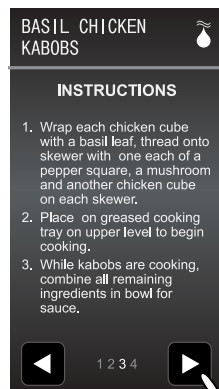

7. Press right arrow to continue to next page.

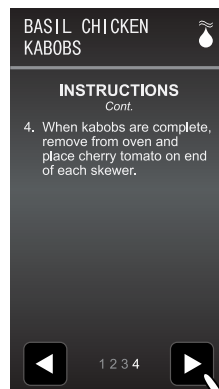

8. Press right arrow to continue to next page.



9. Press **START** for preheat.

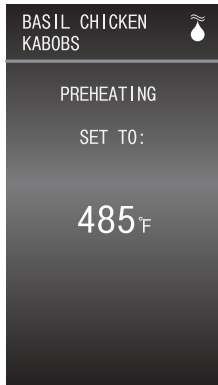

10. Preheating oven.

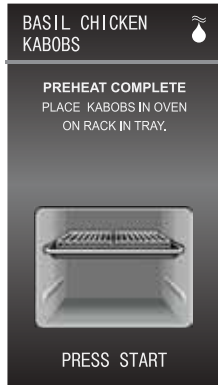

11. Place chicken kabobs in pan on upper level. Press START.

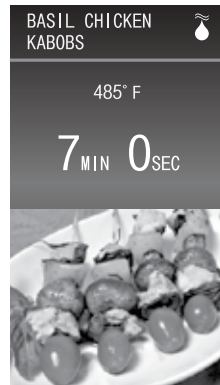

12. Cooking time counts down.

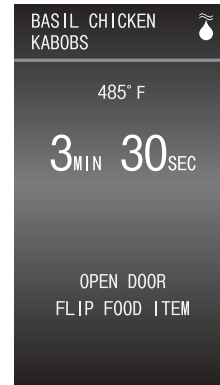

13. When audible sound is on, turn food over.



14. Finished cooking.

## Option for BASIL CHICKEN KABOBS - NUTRITION FACTS:

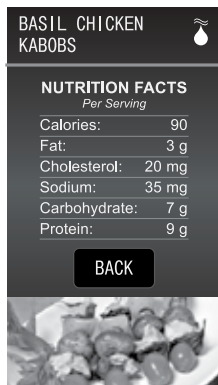

5. At step 4 press NUTRITION FACTS.

# STEAM OPTIONS

HOME PAGE	ICONS	EXAMPLES	WEIGHT	TIME	TEMP
STEAM DEFROST		Chicken Breast	1 lb	40 - 50 mins	100°F
		Ground Beef	1 lb	40 - 50 mins	100°F
		Fish	1 lb	15 - 25 mins	100°F

HOME PAGE	ICONS	MENU SETTING	EXAMPLES	TEMP SETTINGS
STEAM OPTIONS		STEAM PROOF	Bread Dough	100°F
		KEEP WARM	Dinner Plate	150°F
		SIMMER	Casserole	400°F - 200°F
		SAUTE	Onion	475°F
MANUAL		STEAM REFRESH	Fresh Bread	100°F

## STEAM OPTIONS

- To use STEAM PROOF in STEAM OPTIONS:

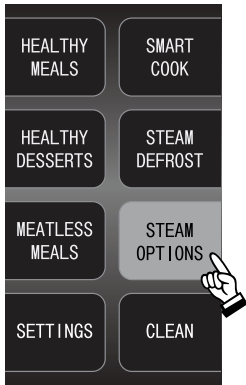

1. Press STEAM OPTIONS.



2. Press STEAM PROOF.

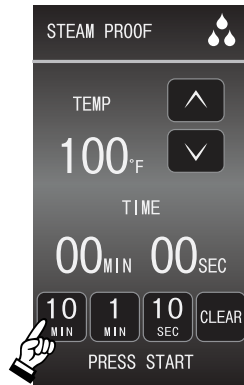

3. Enter desired time.

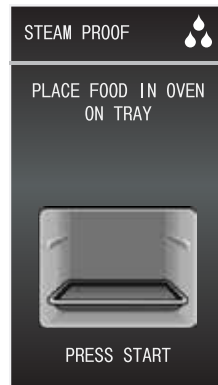

4. Press START.

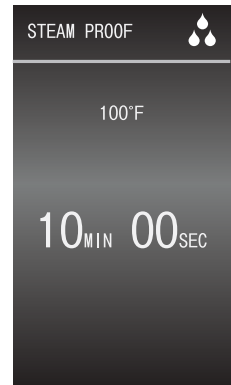

5. Proofing time counts down.



6. Finished proofing.

The Manual cooking option allows you the freedom to choose and explore the full range of cooking features the SuperSteam+ oven has to offer. Each manual cooking option is equipped with its specialized function to ensure optimum cooking performance. Please see the below Manual cooking option explanations to begin your exploration!

**1 Convection Bake** – In the convection bake function, dry heated air is circulated to ensure even cooking throughout the food of choice. This function is representative of traditional convection ovens and best used for baked goods or convenience items.

Examples: cookies, cakes, biscuits, pizza, chicken nuggets

**2 Convection Broil** – The convection broil function incorporates dry heated air that is directed from above the food (top of oven cavity). This broiling function allows for shorter cooking times due to the concentration of the heat. This function is best used for browning, searing, or melting.

Examples: cheese topping, steak, vegetables

**3 Steam Roast** – In this function, the steam that is injected into the cavity is “superheated” steam. Typical steam temperature is 212°F. With “superheated” steam, the temperature of the steam is heightened to levels of up to 485°F; thus allowing for the benefits of steam moisture and the browning effect of the high temperature. This “superheated” steam circulates in the cavity to ensure even cooking. This function is best used for meats, potatoes, or larger items that would require the even cooking effects and browning or outer edge crispness.

Examples: chicken (whole), sweet potato, roast

**4 Steam Grill** – The steam grill function utilizes the “superheated” steam, but in a targeted manner, coming from above in the oven cavity. This pinpoint guidance allows for the benefit of steam as well as being able to concentrate the “superheated” steam temperature to accomplish browning and multiple cooking options. With this function, you are able to grill and sauté while enjoying the benefits of steam.

Examples: fish, vegetables, onions, steak

**5 Steam** – The steam function consists of water vapor at a temperature of 212°F injected into the oven cavity to allow for a nutrient saving cooking option. Steaming provides moisture and tenderness to foods that may otherwise dry out or become tough by using traditional cooking methods. This function is best used for vegetables, fish, or meats.

Examples: broccoli, salmon, cod, chicken

**6 Steam Refresh** – Steam Refresh utilizes low temperature steam that brings back to life or “refreshes” food that may be a day old or yesterday’s leftovers. The injection of gentle steam can help to restore foods back to states of when they were first fresh. This function is best used with firm breads, rice, noodles, vegetables, or meats.

Examples: French bread, brown rice, spaghetti noodles, broccoli, hamburgers

# MANUAL COOKING

- To cook using CONV BAKE manually:



1. Press MANUAL.

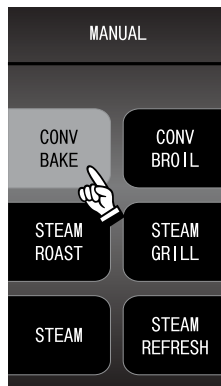

2. Press CONV BAKE.

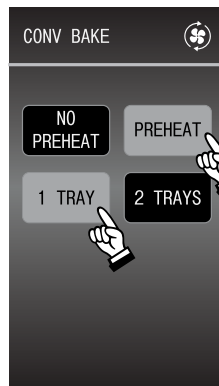

3. Select preheat preference and number of tray.

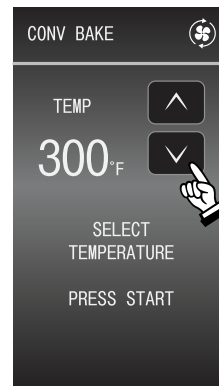

4. Select temperature then press START.



5. Oven is preheating.



6. Place food in the oven.

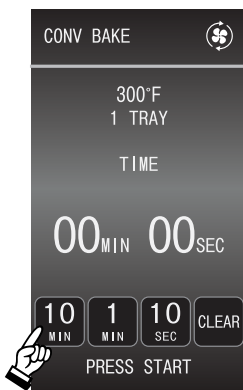

7. Set cooking time, then press START.



8. Cooking time counts down.



9. Finished cooking.

Option for more cooking time:



10. To add more cooking time, press MORE TIME.

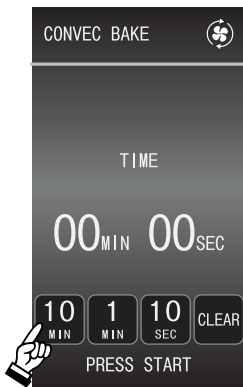

11. Press numbers to add more time, then press START.

## SETTINGS

In the event that the electrical power supply to your oven should be interrupted, your current input settings will be erased. Simply reset this settings once power is reinstated to the oven.

## AUDIBLE SIGNAL ELIMINATION

At the end of timed cook or touch of the screen, beeps will sound. The audible signal can be turned off if you prefer quiet operation.

### TO TURN SOUND OFF

- 1 Press SETTINGS.
- 2 Press SOUND ON/OFF.
- 3 Press OFF.
- 4 Press CLEAR to exit

### TO RESTORE SOUND

- 1 Press SETTINGS.
- 2 Press SOUND ON/OFF.
- 3 Press ON.
- 4 Press CLEAR to exit.

## CONTROL LOCK

The Control Lock prevents unwanted oven operation such as by small children. The oven can be set so that the control panel is deactivated or locked.

### TO LOCK

- 1 Press SETTINGS.
- 2 Press CONTROL LOCK ON/OFF.
- 3 Hold BACK button for 3 seconds.
- 4 Display shows CONTROL LOCK IS ON.
- 5 Pending removal.

### TO UNLOCK

- 1 Hold BACK button for 3 seconds.
- 2 Display shows CONTROL LOCK IS OFF.
- 3 Press CLEAR to exit.

## DEMO MODE

### TO ENTER DEMO MODE

- 1 At Home Page hold CLEAR until it beeps.
- 2 Press CLEAR 4 times.
- 3 The DEMO icon will appear on the screen.
- 4 Proceed in DEMO MODE.

### TO EXIT DEMO MODE

- 1 Repeat steps 1 and 2.
- 2 The DEMO icon will be removed.

#### Note:

- Oven doesn't heat in Demo Mode.
- Display counts down quickly.

## LANGUAGE/TEMP

The oven comes set for English and °F. To change, press SETTINGS then LANGUAGE/TEMP. Once selection is made, press CLEAR to exit.

# CLEANING AND CARE

The Sharp SuperSteam+ Oven offers many options to keep the oven clean. From initial cleaning of your new oven to periodic cleaning, the CLEAN menu helps to keep the oven in peak operational condition and maintain a sparkling and fresh appearance.

## NEW OVEN CLEAN

This is to be used initially to clean the cavity and the accessories that come with this oven before actual cooking. It is recommended to use New Oven Clean before cooking in the oven in order to ensure starting with fresh, clean cooking instruments.

- 1 Select CLEAN from the home page.
- 2 Select NEW OVEN CLEAN from the list provided.
- 3 Insert all accessories (i.e. two trays, two racks) into the oven.
- 4 Fill the reservoir with fresh cold water. Replace reservoir and press START.
- 5 Once NEW OVEN CLEAN is complete, use caution in opening the oven.

### WARNING

- 1 The oven door, outer cabinet and oven cavity will become hot.
- 2 Do not open the oven with your face close to the oven. Steam from the oven may cause burns.

## STERILE CLEANSE

The Sterile Cleanse functions assists in cleaning specific items that require extra care in cleanliness. The chart below lists the items that can be used during this function.

- 1 Select CLEAN from the home page.
- 2 Select STERILE CLEANSE from the list provided.
- 3 Select desired level. Please see chart below for suggested items to cleanse on upper or lower level.
- 4 Fill the reservoir with fresh cold water. Replace reservoir and press START.
- 5 Once STERILE CLEANSE is complete, use caution in opening the oven. The door, cabinet, and oven may be very hot. Do not open with your face close to the oven. The steam from the oven may cause burns.

LEVEL SELECT	SUGGESTED ITEMS FOR CLEANSING
Upper Level (Rack & Tray)	Canning (Jars and Lids)
Lower Level (Tray)	Blanching Small Cutting Boards

## DESCALE FUNCTION

White or gray grains, also called scale, may form in the water circuit inside the oven during steam generation, which could cause the oven to malfunction. The Descal functions helps to breakdown this scale and keep the oven clean and looking like new.

- 1 Select CLEAN from the home page.
- 2 Select DESCALE from the list provided.
- 3 Fill the reservoir a mixture of either water and citric acid or lemon juice. Please see chart below for suggested amounts. Replace the reservoir and press START.
- 4 Once oven has completed the cycle, allow the oven to cool down. Then, wipe away any residue remaining with a damp cloth.
- 5 Remove the reservoir, empty, rinse, and refill with tap water. Replace reservoir and press START.
- 6 Once the DESCALE function is complete, allow the oven to cool down.
- 7 Once cool, wipe oven cavity to dry. Empty the drip tray.

MIXTURE	AMOUNT
Water and Citric Acid	2-1/4 cups water and 1 tablespoon citric acid crystals. Dissolve crystals into water and pour into reservoir.
Water and Lemon Juice	2-1/4 cups water and 1/3 cup 100% lemon juice (no pulp). If the lemon juice contains pulp, please strain. Stir well and pour into the reservoir.

Please do not fill the reservoir with alternative cleaning agents not specified in the chart above. Other cleaning agents may damage your SuperSteam+ oven.

## OVEN CLEANING - STEAM

Steam function helps to loosen any grease, oil or food residue. The steam will make the oven easy to clean; however, it is not a self-cleaning function.

- 1 Select CLEAN from the home page.
- 2 Select OVEN CLEANING – STEAM from the list provided.
- 3 Fill the reservoir with fresh, cold water. Press START.
- 4 Once the OVEN CLEANING – STEAM function is complete, allow the oven to cool down.
- 5 Once cool, wipe any residue remaining with soft, damp cloth.



## EXTERIOR

The outside surface is precoated metal and plastic. Clean the outside with mild soap and water; rinse and dry with a soft cloth. Do not use any type of household or abrasive cleaner.

### STAINLESS STEEL SURFACE

The exterior should be wiped often with a soft damp cloth and polished with a soft dry cloth to maintain its beauty. There are also a variety of products designed especially for cleaning and shining the stainless exterior of the oven. We recommend that the cleaner be applied to a soft cloth and then carefully used on the stainless exterior rather than sprayed directly on to it. Follow package directions carefully.

### FRONT SIDE OF THE OVEN

Wipe the window on both sides with a soft damp cloth to remove any spills or splatters. Metal parts will be easier to maintain if wiped frequently with a soft damp cloth. Avoid the use of spray and other harsh cleaners as they may stain, streak or dull the oven surface.

### TOUCH CONTROL PANEL

If desired, the touch pads may be deactivated before cleaning. See the Control Lock information on page 23 of this manual. Wipe the panel with a cloth dampened slightly with water only. Dry with a soft cloth. Do not scrub or use any sort of chemical cleaners. Close oven and follow directions on page 23 for turning Control Lock off. Press CLEAR.

## INTERIOR

Cleaning is easy because no heat is generated to the interior surfaces; therefore, there is no baking and setting of spills or spattering. To clean the interior surfaces, including oven sealing surfaces, wipe with a soft damp cloth. **DO NOT USE ABRASIVE OR HARSH CLEANERS OR SCOURING PADS.** For heavier soil, use mild soap; wipe clean with a soft damp cloth. Do not use any chemical oven cleaners.

### ODOR REMOVAL

Occasionally, a cooking odor may remain in the oven. To remove odor, combine 1 cup water with 1/3 cup lemon juice in a 2-cup glass. Boil for several minutes. Leave in the oven until water cools. Wipe interior with a soft cloth.

### DRAIN WATER

In the event of excess water being in the SuperSteam+ oven engine or a steam function is interrupted during operation, your oven may need to drain to reset itself.

An ATTENTION message will be displayed alerting the need for the oven to drain the water.

Ensure that there is an empty reservoir. If not, empty the reservoir and replace.

The draining of the water into the reservoir will take approximately 1 minute.

Once complete, detach the reservoir and discard the water.

# BEFORE YOU CALL FOR SERVICE

Please check the following before calling for service. It may save you time and expense.

PROBLEM	POSSIBLE CAUSE	SOLUTION
<b>1</b> Part or all of oven does not operate.	<ul style="list-style-type: none"><li>• Power cord of oven is not completely connected to the electrical outlet.</li><li>• Power outage.</li><li>• Fuse/circuit breaker at home doesn't work.</li><li>• Oven is in Demo Mode.</li></ul>	<ul style="list-style-type: none"><li>• Make sure the power cord is tightly connected to the outlet.</li><li>• Check house lights to be sure. Call your local electric company for service.</li><li>• Replace the fuse or reset the circuit breaker.</li><li>• See page 23 for how to cancel Demo Mode.</li></ul>
<b>2</b> Food in oven is not heated.	<ul style="list-style-type: none"><li>• No power to the appliance.</li><li>• Oven controls improperly set.</li><li>• Oven is in Demo Mode.</li></ul>	<ul style="list-style-type: none"><li>• See SOLUTION for PROBLEM 1.</li><li>• Check if the controls have been properly set.</li><li>• See page 23.</li></ul>
<b>3</b> Oven light does not work.	<ul style="list-style-type: none"><li>• Light bulb is loose or burned out.</li></ul>	<ul style="list-style-type: none"><li>• Call for service.</li></ul>
<b>4</b> Touch controls will not operate.	<ul style="list-style-type: none"><li>• Control Lock is on.</li></ul>	<ul style="list-style-type: none"><li>• See page 23 to unlock.</li></ul>
<b>5</b> Display flashes.	<ul style="list-style-type: none"><li>• Power failure.</li></ul>	<ul style="list-style-type: none"><li>• Press Clear pad and reset the clock. If the oven was in use, you must reset the cooking function.</li></ul>

# SHARP®

SHARP ELECTRONICS CORPORATION • 1 Sharp Plaza, Suite 1 • Mahwah, New Jersey 07495-1123 • USA

SHARP ELECTRONICS OF CANADA LTD • 335 Britannia Road East • Mississauga, Ontario • L4Z 1W9 • Canada