



**flexwash™**

---

**User manual**

WV60M9900A\*

---

**SAMSUNG**

# Contents

---

<b>Safety information</b>	<b>4</b>
What you need to know about the safety instructions	4
Important safety symbols	4
Important safety precautions	5
Critical installation warnings	6
Installation cautions	8
Critical usage warnings	8
Usage cautions	10
Critical cleaning warnings	14
<b>Regulatory notice</b>	<b>15</b>
<b>Installation</b>	<b>18</b>
Unpacking your washer	18
What's included	19
Installation requirements	21
Step-by-step installation	25
<b>Before you start</b>	<b>35</b>
Initial settings	35
Laundry guidelines	35
Guide to cleaning agents	38
<b>Operations</b>	<b>43</b>
Upper washer	43
Lower washer	45
Simple steps to start	50
Samsung Smart Home	51
Special features	53
<b>Maintenance</b>	<b>56</b>
General considerations	56
Upper washer	59
Lower washer	61

---

<b>Troubleshooting</b>	<b>67</b>
Checkpoints	67
Samsung Smart Home	72
Information codes	73
<b>Specifications</b>	<b>77</b>
Fabric care chart	77
Protecting the environment	78
Declaration of conformity	78
Specification sheet	79
Cycle chart	80



# Safety information

---

Congratulations on your new Samsung washer. This manual contains important information on the installation, use and care of your appliance. Please take some time to read this manual to take full advantage of your washer's many benefits and features.

## What you need to know about the safety instructions

---

Please read this manual thoroughly to ensure that you know how to safely and efficiently operate the extensive features and functions of your new appliance. Please store the manual in a safe location close to the appliance for future reference. Use this appliance only for its intended purpose as described in this instruction manual.

Warnings and Important Safety Instructions in this manual do not cover all possible conditions and situations that may occur. It is your responsibility to use common sense, caution, and care when installing, maintaining and operating your washer.

Because the following operating instructions cover various models, the characteristics of your washer may differ slightly from those described in this manual and not all warning signs may be applicable. If you have any questions or concerns, contact your nearest service center or find help and information online at [www.samsung.com](http://www.samsung.com).

## Important safety symbols

---

What the icons and signs in this user manual mean:

 **WARNING**

Hazards or unsafe practices that may result in severe personal injury, death and/or property damage.

 **CAUTION**

Hazards or unsafe practices that may result in personal injury and/or property damage.

 **NOTE**

Indicates that a risk of personal injury or material damage exists.

These warning signs are here to prevent injury to yourself and others.

Please follow them explicitly.

After reading this manual, store it in a safe place for future reference.

Read all instructions before using the appliance.

As with any equipment that uses electricity and moving parts, potential hazards exist.

To safely operate this appliance, familiarize yourself with its operation and exercise care when using it.

# SAVE THESE INSTRUCTIONS



---

## Important safety precautions

---

### **WARNING**

To reduce the risk of fire, electric shock, or injury to persons when using your appliance, follow basic precautions, including the following:

1. Read all instructions before using the appliance.
2. Do not wash or dry articles that have been previously cleaned in, washed in, soaked in, or spotted with gasoline, dry-cleaning solvents, other flammable or explosive substances as they give off vapors that could ignite or explode.
3. Do not allow children to play on or in the appliance. Close supervision of children is necessary when the appliance is used near children.
4. Before the appliance is removed from service or discarded, remove the door to the washing or drying compartment.
5. Do not reach into the appliance if the drum is moving.
6. Do not install or store this appliance where it will be exposed to the weather.
7. Do not tamper with controls.
8. Do not repair or replace any part of the appliance or attempt any servicing unless specifically recommended in the user-maintenance instructions or in published user repair instructions that you understand and have the skills to carry out.
9. Do not add gasoline, dry-cleaning solvents, or other flammable or explosive substances to the wash water. These substances give off vapors that could ignite or explode.
10. Under certain conditions, hydrogen gas may be produced in a hot water system that has not been used for 2 weeks or more. **HYDROGEN GAS IS EXPLOSIVE.** If the hot water system has not been used for such a period, before using a washer or combination washer-dryer, turn on all hot water faucets and let the water flow from each for several minutes. This will release any accumulated hydrogen gas. As the gas is flammable, do not smoke or use an open flame during this time.

# SAVE THESE INSTRUCTIONS

# Safety information

---

## Critical installation warnings

---

### **State of California Proposition 65 Warning (US only)**

This product contains chemicals known to the State of California to cause cancer and birth defects or other reproductive harm.

The installation of this appliance must be performed by a qualified technician or service company.

- Failure to do so may result in electric shock, fire, an explosion, problems with the product, or injury.

The appliance is heavy, therefore take care when lifting it.

Plug the power cord into a wall socket that meets local electrical specifications. Use the socket for this appliance only, and do not use an extension cord.

- Sharing a wall socket with other appliances, using a power strip, or extending the power cord may result in electric shock or fire.
- Ensure that the voltage, frequency, and current supplied to the washer matches those listed in the product specifications. Failure to do so may result in electric shock or fire. Plug the power plug into the wall socket firmly.

Have this appliance installed by a qualified technician or service company.

- Failing to do so may result in electric shock, fire, an explosion, problems with the product, or injury.

Remove all foreign substances such as dust or water from the power plug terminals and contact points using a dry cloth on a regular basis.

- Unplug the power plug and clean it with a dry cloth.
- Failure to do so may result in electric shock or fire.

Plug the power plug into the wall socket so that the cord is running towards the floor.

- If you plug the power plug into the socket in the opposite direction, the electric wires within the cable may be damaged and this may result in electric shock or fire.

Keep all packaging materials out of the reach of children as these may be dangerous.

- If a child places a plastic bag over his or her head, he or she can suffocate.

## SAVE THESE INSTRUCTIONS

If the appliance, power plug, or power cord is damaged, contact your nearest Samsung service center for service.

This appliance must be properly grounded.

Do not ground the appliance to a gas pipe, plastic water pipe, or telephone line.

- This may result in electric shock, fire, an explosion, or problems with the product.
- Never plug the power cord into a socket that is not grounded correctly. Make sure that the socket is in accord with local and national regulations.

Do not install this appliance near a heater or any flammable material.

Do not install this appliance in a humid, oily or dusty location, or in a location exposed to direct sunlight or water (rain drops).

Do not install this appliance in a location exposed to low temperatures.

- Frost may cause the tubes to burst.

Do not install this appliance in a location where gas may leak.

- This may result in electric shock or fire.

Do not use an electric transformer to power the washer.

- This may result in electric shock or fire.

Do not use a damaged power plug, damaged power cord, or loose wall socket.

- This may result in electric shock or fire.

Do not pull or bend the power cord excessively.

Do not twist or tie the power cord.

Do not hook the power cord over a metal object, place a heavy object on the power cord, insert the power cord between objects, or push the power cord into the space behind the appliance.

- This may result in electric shock or fire.

Do not pull the power cord when unplugging the power plug.

- Unplug the power plug by pulling the plug.
- Failure to do so may result in electric shock or fire.

This appliance should be positioned so that the power plug, the water supply taps, and the drain pipes are accessible.

## SAVE THESE INSTRUCTIONS

# Safety information

---

## Installation cautions

---

### CAUTION

This appliance should be positioned in such a way that the power plug is easily accessible.

- Failure to do so may result in electric shock or fire due to electric leakage.

Install your appliance on a solid, level floor that can support its weight.

- Failure to do so may result in abnormal vibrations, movement, noise, or problems with the product.

## Critical usage warnings

---

### WARNING

If the appliance is flooded, turn off the water and power supplies immediately and contact your nearest Samsung service center.

- Do not touch the power plug with wet hands.
- Failure to do so may result in electric shock.

If the appliance generates a strange noise, a burning smell, or smoke, unplug the power plug immediately and contact your nearest Samsung service center.

- Failure to do so may result in electric shock or fire.

In the event of a gas leak (such as propane gas, LP gas, etc.), ventilate the room immediately without touching the power plug. Do not touch the appliance or power cord.

- Do not use a ventilating fan. Do not turn on a light.
- A spark may result in an explosion or fire.

Do not let children play in or on the washer. In addition, when disposing of the appliance, remove the washer door lever.

- Children can suffocate to death if trapped inside the product.

Make sure to remove the packaging (sponge, styrofoam) attached to the bottom of the washer before using it.

Do not wash items contaminated with gasoline, kerosene, benzene, paint thinner, alcohol or other flammable or explosive substances in the washer.

- This may result in electric shock, fire, or an explosion.

## SAVE THESE INSTRUCTIONS



Do not open the washer door by force while it is operating (high-temperature washing/drying/spinning).

- Water flowing out of the washer may result in burns or cause the floor to be slippery. This may result in injury.
- Opening the door by force may result in damage to the product or injury.

Do not insert your hand under the washer while an operation is in progress.

- This may result in injury.

Do not touch the power plug with wet hands.

- This may result in electric shock.

Do not operate the appliance with wet hands.

- This may result in electric shock.

Do not turn the appliance off by unplugging the power plug while an operation is in progress.

- Plugging the power plug into the wall socket again may cause a spark and result in electric shock or fire.

Do not let children or the infirm use this washer without proper supervision. Do not let children climb in or onto the appliance.

- This may result in electric shock, burns, or injury.

Do not insert your hand or a metal object under the washer while it is operating.

- This may result in injury.

Do not unplug the appliance by pulling the power cord. Always grip the plug firmly and pull it straight out of the outlet.

- Damage to the power cord may cause a short-circuit, fire, and/or electric shock.

Do not attempt to repair, disassemble, or modify the appliance yourself.

- Do not use a fuse (such as copper, steel wire, etc.) other than a standard fuse.
- If the appliance needs to be repaired or reinstalled, contact your nearest Samsung service center.
- Failure to do so may result in electric shock, fire, problems with the product, or injury.

If the water supply hose comes loose from the faucet and floods the appliance, unplug the power plug.

- Failure to do so may result in electric shock or fire.

## SAVE THESE INSTRUCTIONS

# Safety information

---

Unplug the power plug when the appliance is not being used for long periods of time or during a thunder or lightning storm.

- Failure to do so may result in electric shock or fire.

If any foreign substance enters the appliance, unplug the power plug and contact your nearest Samsung service center.

- This may result in electric shock or fire.

Do not let children (or pets) play in or on your washer. The washer door does not open easily from the inside and children may be seriously injured if trapped inside.

## Usage cautions

---

### CAUTION

If the washer is contaminated by a foreign substance such as detergent, dirt, food waste, etc., unplug the power plug and clean the washer using a damp, soft cloth.

- Failure to do so may result in discoloration, deformation, damage, or rust.

The front glass (or lid) may be broken by a strong impact. Take care when using the washer.

- If the glass is broken, it may result in injury.

After a water supply failure or when reconnecting the water supply hose, open the faucet slowly.

Open the faucet slowly after a long period of non-use.

- The air pressure in the water supply hose or the water pipe may damage a product part or result in a water leak.

If a draining error occurs during an operation, check if there is a draining problem.

- If the washer is used when it is flooded because of a draining problem, it may result in electric shock or fire.

Insert the laundry into the washer completely so that the laundry does not get caught in the door.

- If laundry gets caught in the door, it may result in damage to the laundry or the washer, or result in a water leak.

Turn the water supply off when the washer is not being used.

- Ensure that the water supply hose connectors are properly tightened.

## SAVE THESE INSTRUCTIONS

Ensure that the rubber seal and front door glass are not contaminated by a foreign substance (e.g. waste, thread, hair, etc.).

- If a foreign substance is caught in the door or the door is not completely closed, it may cause a water leak.

Open the faucet and check if the water supply hose connectors are firmly tightened and that there are no water leaks before using the product.

- If the connectors on the water supply hoses are loose, it may result in a water leak.

The product you have purchased is designed for domestic use only.

Using the product for business purposes qualifies as product misuse. If the product is used for business purposes, the product will not be covered by the standard warranty provided by Samsung and no responsibility can be attributed to Samsung for malfunctions or damages resulting from such misuse.

Do not stand on the appliance or place objects (such as laundry, lighted candles, lighted cigarettes, dishes, chemicals, metal objects, etc.) on the appliance.

- This may result in electric shock, fire, problems with the product, or injury.

Do not spray volatile material such as insecticide onto the surface of the appliance.

- As well as being harmful to humans, this may result in electric shock, fire, or problems with the product.

Do not place objects that generate electromagnetic fields near the washer.

- This may result in injury due to a malfunction.

Water drained during a high-temperature wash or drying cycle is hot. Do not touch the water.

- This may result in burns or injury.

Do not wash, spin, or dry water-proof seats, mats, or clothing (\*) unless your appliance has a special cycle for washing these items.

For waterproof fabrics, only use the WATERPROOF cycle. Do not use other cycles for waterproof fabrics (WATERPROOF cycle-featured models only).

(\*): Woollen bedding, rain covers, fishing vests, ski pants, sleeping bags, diaper covers, sweat suits, and bicycle, motor cycle and car covers, etc.

- Do not wash thick or hard mats even if the washer mark is on the care label. This may result in injury or damage to the washer, walls, floor, or clothing due to abnormal vibrations.

## SAVE THESE INSTRUCTIONS

# Safety information

---

- Do not wash throw rugs or doormats with rubber backing in the washer. The rubber backing may come off and stick to inside the drum, and this may result in a malfunction such as a drainage error.

Do not operate the washer when the detergent drawer is removed.

- This may result in electric shock or injury due to a water leak.

Do not touch the insides of the drum during or just after drying as it is hot.

- This may result in burns.

Do not insert your hand into the detergent drawer.

- This may result in injury as your hand may be caught by the detergent input device.
- Do not use the liquid detergent container (on applicable models only) for powdered detergent. Remove the container and put powdered detergent directly into the Main wash compartment.

Do not place any objects (such as shoes, food waste, animals) other than laundry into the washer.

- This may result in damage to the washer, or injury and death in the case of pets due to abnormal vibrations.

Do not press the buttons using sharp objects such as pins, knives, fingernails, etc.

- This may result in electric shock or injury.

Do not wash laundry contaminated by oils, creams, or lotions usually found in skincare shops or massage clinics.

- This may cause the rubber seal to become deformed and result in a water leak.

Do not leave metal objects such as safety pins or hair pins in the drum for long periods of time. Do not leave bleach in the drum for long periods of time.

- Doing either may cause the drum to rust.
- If rust starts appearing on the surface of the drum, apply a (neutral) cleansing agent to the surface and use a sponge to clean it. Never use a metal brush.

Do not use dry cleaning detergent in the washer and do not wash, rinse, or spin laundry contaminated by dry cleaning detergent.

- This may result in spontaneous combustion or ignition due to the heat from the oxidation of the oil.

Do not use water from water cooling/heating devices.

- This may result in problems with the washer.

## SAVE THESE INSTRUCTIONS

---

Do not use natural hand-washing soap in the washer.

- If it hardens and accumulates inside the washer, it may result in problems with the product, discoloration, rust, or bad odors.

Place socks and brassieres in a washing net and wash them with the other laundry.

Do not wash large laundry items such as bedding in the washing net.

- Failure to do so may result in injury due to abnormal vibrations.
- Place smaller items, such as lace socks and lingerie in the washing net.

Do not use hardened detergent.

- If it accumulates inside the washer, it may result in a water leak.

Make sure that the pockets of all the clothing items to be washed are empty.

- Hard, sharp objects such as coins, safety pins, nails, screws, or stones can cause extensive damage to the washer.

Do not wash clothing with large buckles, buttons, or other heavy metal objects in the washer.

Sort the laundry by color on the basis of its colorfastness and select the recommended cycle, water temperature, and additional functions.

- Failure to do this may result in discoloration or fabric damage.

Take care that children's fingers are not caught in the door when you close it.

- Failure to do so may result in injury.

**SAVE THESE INSTRUCTIONS**

# Safety information

---

## Critical cleaning warnings

---

### WARNING

Do not clean the appliance by spraying water directly onto it.

Do not use a strong acidic cleaning agent.

Do not use benzene, thinner, or alcohol to clean the appliance.

- This may result in discoloration, deformation, damage, electric shock, or fire.

Before cleaning the washer or performing maintenance, unplug it from the wall socket.

- Failure to do so may result in electric shock or fire.

## SAVE THESE INSTRUCTIONS

# Regulatory notice

---

## FCC Notice

---

### CAUTION

Any changes or modifications not expressly approved by the party responsible for compliance could void the user's authority to operate the equipment.

This device complies with Part 15 of FCC Rules. Operation is Subject to following two conditions:

1. This device may not cause harmful interference, and
2. This device must accept any interference received including interference that cause undesired operation.

For products sold in the US and Canadian markets, only channels 1-11 are available. You cannot select any other channels.

### FCC STATEMENT:

This equipment has been tested and found to comply within the limits for a Class B digital device, pursuant to part 15 of the FCC Rules. These limits are designed to provide reasonable protection against harmful interference in a residential installation.

This equipment generates, uses, and can radiate radio frequency energy and, if not installed and used in accordance with the instructions, may cause harmful interference to radio communications. However, there is no guarantee that interference will not occur in a particular installation. If this equipment does cause harmful interference to radio or television reception, which can be determined by turning the equipment off and on, the user is encouraged to try to correct the interference by one or more of the following measures:

- Reorienting or relocating the receiving antenna
- Increasing the separation between the equipment and receiver
- Connecting the equipment to an outlet that is on a different circuit than the radio or TV.
- Consulting the dealer or an experienced radio/TV technician for help.

### FCC RADIATION EXPOSURE STATEMENT:

This equipment complies with FCC radiation exposure limits set forth for an uncontrolled environment. This equipment should be installed and operated so there is at least 8 inches (20 cm) between the radiator and your body. This device and its antenna(s) must not be colocated or operated in conjunction with any other antenna or transmitter.

## SAVE THESE INSTRUCTIONS



# Regulatory notice

---

## IC Notice

---

The term "IC" before the radio certification number only signifies that Industry Canada technical specifications were met. Operation is subject to the following two conditions:

1. This device may not cause interference, and
2. This device must accept any interference, including interference that may cause undesired operation of the device.

This Class B digital apparatus complies with Canadian ICES-003.

Cet appareil numérique de la classe B est conforme à la norme NMB-003 du Canada.

For products sold in the US and Canadian markets, only channels 1-11 are available. You cannot select any other channels.

### IC RADIATION EXPOSURE STATEMENT:

This equipment complies with IC RSS-102 radiation exposure limits set forth for an uncontrolled environment. This equipment should be installed and operated so there is at least 8 inches (20 cm) between the radiator and your body. This device and its antenna(s) must not be colocated or operated in conjunction with any other antenna or transmitter.



## SAVE THESE INSTRUCTIONS





---

## Open Source License Notice

---

The software included in this product contains open source software. You may obtain the complete corresponding source code for a period of three years after the last shipment of this product by sending an email to <mailto:oss.request@samsung.com>.

It is also possible to obtain the complete corresponding source code in a physical medium such as a CD-ROM; a minimal charge will be required.

The following URL <http://opensource.samsung.com/opensource/SimpleConnectTP/seq/0> leads to the download page of the source code made available and open source license information as related to this product. This offer is valid to anyone in receipt of this information.



**SAVE THESE INSTRUCTIONS**

# Before you start

---

## Initial settings

---

### Run Calibration (recommended)

Calibration ensures accurate weight detection by the washer. Make sure the tub or drum is empty before running Calibration.

#### To calibrate the upper washer

1. Press **POWER** on the control panel of the upper washer to turn the washer on.
2. Press and hold **NORMAL** and **Temp.** simultaneously for 3 seconds.
3. Press **START/PAUSE** to start Calibration.
  - The door is locked during the operation.
  - The tub keeps rotating clockwise and counter clockwise for several minutes.

4. When complete, the upper washer turns off automatically.

#### To calibrate the lower washer

1. Press **POWER** on the control panel of the lower washer to turn the washer on.
2. Press and hold **Temp.** and **Delay End** on the lower washer control panel simultaneously for 3 seconds.
3. Press **START/PAUSE** on the lower washer control panel to start Calibration.
4. When complete, the lower washer turns off automatically.

#### **NOTE**

Instead of rotating the tub, the lower washer rotates the drum.

## Laundry guidelines

---

### STEP 1 Sort

---

Sort the laundry according to these criteria:

- Care Label: Sort the laundry into cottons, mixed fibres, synthetics, silks, wools, and rayon.
- Color: Separate whites from colors.
- Size: Mixing different sized items together in the drum or tub improves the washing performance.

- Sensitivity: Wash delicate items separately. For pure, new woollen items, curtains, and silk items, check the labels for washing instructions.

#### **NOTE**

Make sure to check the care label on all clothing, and sort clothing accordingly before starting the wash.

# Before you start

---

## STEP 2 Empty pockets

---

Empty all the pockets of your laundry items

- Metal objects such as coins, pins, and buckles on clothing may damage other laundry items as well as the drum or tub.

Turn clothing with buttons and embroideries inside out

- If pants or jacket zippers are open while washing, the drum or tub may be damaged. Zippers should be closed and fixed with a string.
- Clothing with long strings may become entangled with other clothes. Make sure to tie the strings before starting the wash.

## STEP 3 Use a laundry net

---

- Brassieres (water washable) must be placed in a laundry net. Metal parts of the brassieres may break through and tear other laundry items.
- Small, light clothing such as socks, gloves, stockings, and handkerchiefs may become caught around the door. Place them inside a fine laundry net.
- Do not wash the laundry net by itself without other laundry. This may cause abnormal vibrations that could move the washer and result in injury.

## STEP 4 Determine the load capacity

---

Lower washer

Do not overload the washer. Overloading may cause the washer to wash improperly.

### NOTE

When washing bedding or bedding covers, the wash time may be lengthened or the spin efficiency may be reduced. For bedding or bedding covers, the recommended maximum spin level is “Low or Medium Spin”, and the load capacity is 3.0 kg or less.

### CAUTION

If the laundry is unbalanced and the “Ub” information code is displayed, redistribute the load. Unbalanced laundry may reduce the spinning performance.

## Upper washer

### Laundry guidelines

Use the upper washer for small loads under 3.3 lbs (1.5 kg).

Load	Shorts	Blue Jeans	Cotton pants	Shirts	Short-sleeved T-shirts
3.3 lb ↓ (1.5 kg ↓)	4	1	3	4	9
Load	T-shirts	Sports wear (upper)	Sports wear (pants)	Shower towel	Towel (small)
3.3 lb ↓ (1.5 kg ↓)	4	3	3	2	10

#### NOTE

- Use the recommended load for optimal washing performance. Overloads may reduce the performance.
- Use the lower washer for stubborn or heavily soiled loads or loads larger than recommended.

## STEP 5 Add the correct detergent type

The type of detergent depends on the type of fabric (cotton, synthetic, delicate items, wool), color, wash temperature, and degree of soiling. Always use “low suds” HE laundry detergent which is designed for automatic washers.

#### NOTE

- Follow the detergent manufacturer’s recommendations based on the weight of the laundry, the degree of soiling, and the hardness of the water in your local area. If you are not sure about the water hardness, contact your local water authority.

- Do not use detergent that has hardened or solidified. This detergent may remain after the rinse cycle, blocking the drain outlet.

### Use HE detergent only



Your washer is designed to use high efficiency (HE) detergents.

- For the best cleaning results, use a high efficiency detergent such as Tide HE, Wisk HE, Cheer HE or Gain HE\*. High efficiency detergents contain suds suppressors that reduce or eliminate suds. When fewer suds are produced, the load tumbles more efficiently and cleaning is maximized. (\* Brand names are trademarks of their respective manufacturers.)

#### WARNING

Regular detergent is not recommended. Use HE detergents only.

# Before you start

## Guide to cleaning agents

### Upper washer

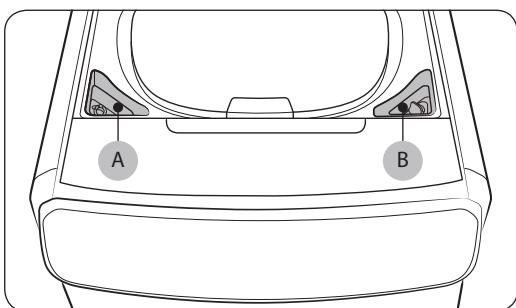

The upper washer provides two cleaning agent compartments: the left-side compartment for bleach, and the right side for fabric softener. You can apply detergent manually into the tub using the provided Aqua Pebble.

- **Bleach compartment (A):** Add non-chlorine bleach as instructed by the manufacturer.
- **Softener compartment (B):** Add a recommended amount of fabric softener as instructed by the manufacturer.

### To apply cleaning agents to the upper washer

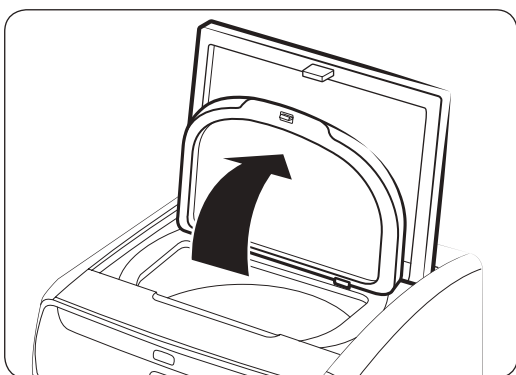

1. Open the top door, and then the protective cover. Remove the Aqua Pebble from the fabric softener container.

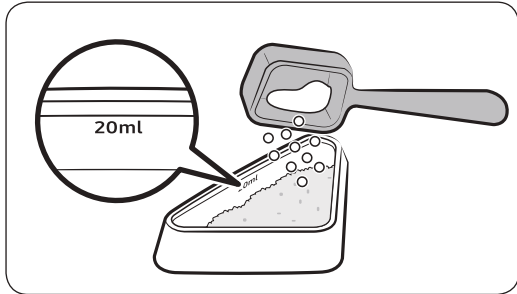

- Put a recommended amount of liquid or powdered detergent into the provided Aqua Pebble. The Aqua Pebble has a guide line (marked '20 ml') near its top, which is the max line. Do not exceed the max line.

**⚠ CAUTION**

- Any detergent to be added to the upper washer must be put in the provided Aqua Pebble.
- Use HE detergent only.
- If you are adding powdered detergent, use the provided detergent cup, and add only one cup of detergent. Excessive amounts of detergent may cause detergent residue.
- Make sure the powdered detergent you add is a finely ground variety.
- Do not use the Aqua Pebble for bleach and/or fabric softener.

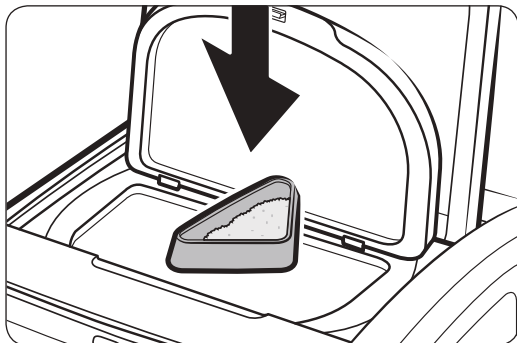

- Insert the Aqua Pebble around the center of the tub, and then put the laundry over the Aqua Pebble.

**⚠ CAUTION**

Make sure the Aqua Pebble is input first so it is placed under the laundry. Otherwise, detergent may not dissolve fully, causing residue after the wash is complete.

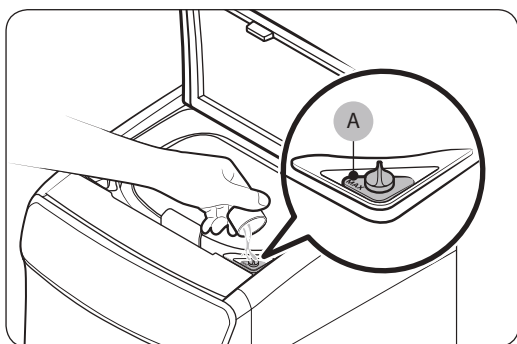

- Add a recommended amount of fabric softener to the softener compartment. Do not exceed the **max line (A)**.

Before you start

# Before you start

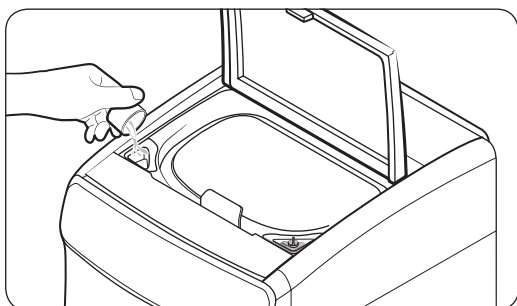

5. Add a recommended amount of non-chlorine bleach to the bleach compartment. Use caution not to overfill the compartment.
6. Close the protective cover, and then the top door.

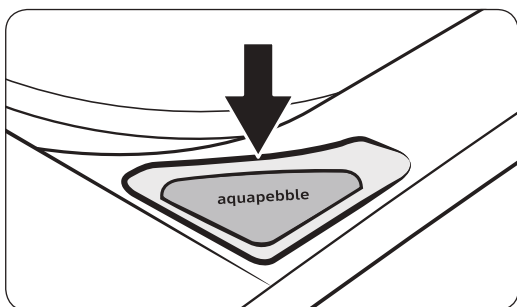

## NOTE

When the cycle is complete, take out the Aqua Pebble, turn it over, and put it on the softener compartment for later use (see the figure). The Aqua Pebble is designed to fit in the softener compartment after it has been turned over.

## CAUTION

- Do not use chlorine bleach, which may damage the laundry.
- Use caution when inserting the Aqua Pebble as it is supposed to be balanced on top of the laundry at the beginning of the wash. Tipping the Aqua Pebble before the start of a wash may cause detergent residue to remain on the laundry at the end of the wash, causing discoloration of the laundry and/or reduced washing performance.
- Before each wash, make sure to clean the Aqua Pebble before adding fresh detergent.
- Do not insert the Aqua Pebble into a folded item or between different laundry items.
- Do not use liquid or powdered chlorine bleach.
- Do not put or store cleaning agents such as detergent, bleach, and fabric softener on top of your washer. Wipe up any spills immediately to prevent damage to the washer, especially the finish and the control panels.

## NOTE

- It is normal for a small amount of water to remain in the detergent compartments at the end of a cycle.
- When adding color-safe bleach, we recommend you also use liquid detergent.
- When the wash is complete, remove the Aqua Pebble from the tub and clean it so that it is readily available for later use.

## Lower washer

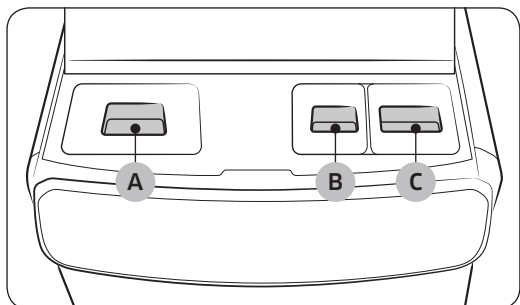

The lower washer provides three cleaning agent compartments: the left-most compartment for the main wash, the right-first one for bleach, and the far right for fabric softener.

- **Main wash compartment (A):** Add a recommended amount of liquid (or powdered) detergent to the main wash compartment.
- **Bleach compartment (B):** Add chlorine bleach as instructed by the manufacturer.
- **Softener compartment (C):** Add a recommended amount of fabric softener to the softener compartment.

### CAUTION

- Do not use ball or net types of detergent.
- Do not put tablet or capsule types of detergent in the detergent compartment. Tablet or capsule types of detergent must be put directly in the drum.
- To prevent the compartment from clogging, concentrated or highly-enriched agents (fabric softener or detergent) must be diluted with water before being added.

### To apply cleaning agents to the lower washer

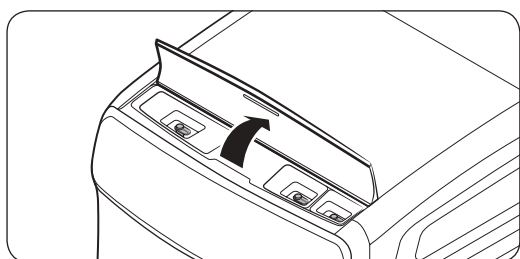

1. Open the top-front cover.



# Before you start

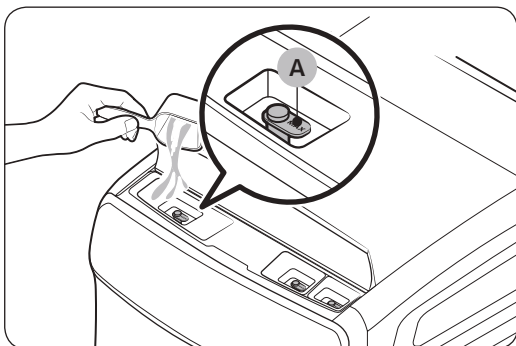

2. Add a recommended amount of liquid or powdered detergent to the detergent compartment. Do not exceed the **max line (A)**.

## **NOTE**

To apply powdered detergent, first remove the liquid detergent container.

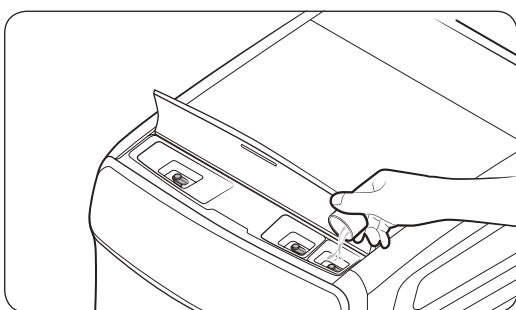

3. Add a recommended amount of fabric softener to the softener compartment. Do not exceed the max line.

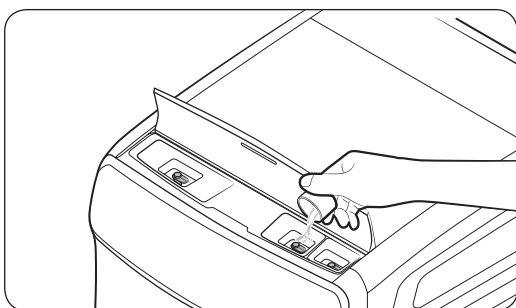

4. If you want to add bleach, add a recommended amount of chlorine bleach to the bleach compartment. Do not exceed the max line.
5. Close the top-front cover.

## **NOTE**

- If you use a high efficiency (HE) detergent, apply  $\frac{2}{3}$  of the recommended amount to the main wash compartment.
- Oxygen boosters can increase washing performance. Make sure to add the oxygen booster after putting the laundry into the drum.
- To use both powdered detergent and powdered oxygen booster, it is more effective to put them together into the drum before loading the laundry.

# Operations

Your dual loading washer features upper and the lower washers for your convenience. The upper washer is an automatic tub loader that is designed to wash relatively small loads while the lower washer is a drum loader that takes care of normal or relatively heavy loads. The main panel is divided into 2 independent control panels.

## **WARNING**

To reduce the risk of fire, electric shock, or injury to persons, read the IMPORTANT SAFETY INSTRUCTIONS before operating this washer.

## Upper washer

### Control panel

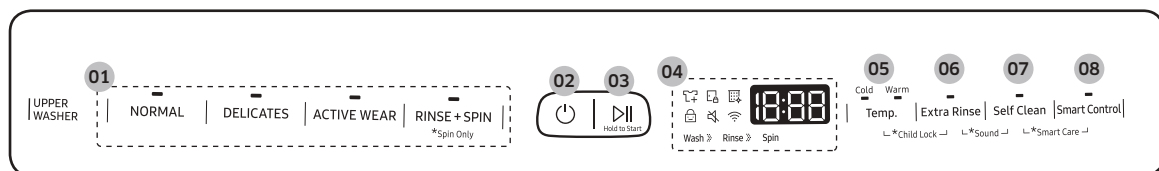

<b>01 Cycle bar</b>	Press to select a cycle.
<b>02 POWER</b>	Press to turn the upper washer on or off.
<b>03 START/PAUSE (Hold to Start)</b>	Press and hold to start operation or press to stop operation temporarily.
<b>04 Status bar</b>	The status bar shows current cycle information and estimated time remaining, or an information code if the upper washer needs to be checked.
<b>05 Temp.</b>	Press to toggle between two different water temperature options. <ul style="list-style-type: none"> <li>• <b>Warm:</b> Colorfast items.</li> <li>• <b>Cold:</b> Brightly colored, very lightly soiled items.</li> </ul>
<b>06 Extra Rinse</b>	Use to add an additional rinse at the end of the cycle to remove laundry additives more thoroughly.
<b>07 Self Clean</b>	Use to clean dirt and bacteria from the tub. Regular use (after every 20 washes) is recommended. No detergent or bleach is needed. Make sure the tub is empty.
<b>08 Smart Control</b>	After connecting the upper washer to your home network using the Samsung Smart Home app, you can control the washer remotely. When started, the Smart Control indicator blinks and the top door locks. The washer enters waiting mode and waits for remote commands. For more information, visit the Samsung Smart Home page.

# Operations

## Cycle overview

Cycle	Description
NORMAL	<ul style="list-style-type: none"><li>• For lightly soiled cotton, t-shirts, towels, and mixed loads.</li><li>• Use to wash lightly soiled normal items, except delicate fabrics such as silk or handwash-only fabrics.</li></ul>
DELICATES	<ul style="list-style-type: none"><li>• For sheer fabrics, bras, lingerie, silks, and other handwash-only fabrics. For best results, use liquid detergent.</li></ul>
ACTIVE WEAR	<ul style="list-style-type: none"><li>• For exercise wear such as training pants, shirts/tops, and other performance clothing. This cycle provides effective soil removal with controlled tub rotation for special fabric care.</li></ul>
RINSE+SPIN	<ul style="list-style-type: none"><li>• For loads that need rinsing only or for loads you want to add rinse-aided fabric softener to.</li></ul> <p> <b>NOTE</b> <b>Spin Only:</b> This cycle runs a spin cycle only. Press and hold <b>RINSE+SPIN</b> for 3 seconds.</p>

## Lower washer

### Control panel

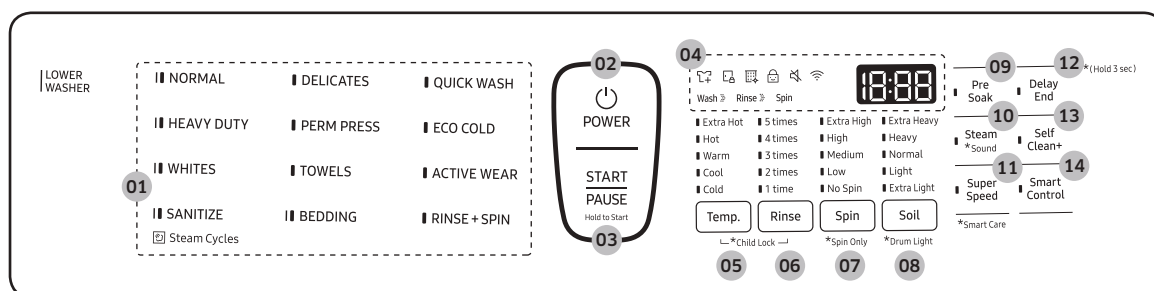

<b>01</b> Cycle area	Press to select a cycle.
<b>02</b> POWER	Press to turn the lower washer on or off.
<b>03</b> START/PAUSE (Hold to Start)	Press and hold to start operation or press to stop operation temporarily.
<b>04</b> Status bar	The status bar shows current cycle information and estimated time remaining or an information code if the lower washer needs to be checked.
<b>05</b> Temp.	<ul style="list-style-type: none"> <li><b>Extra Hot:</b> Heavily soiled, colorfast items. Only available with NORMAL, HEAVY DUTY, SANITIZE and Self Clean+.</li> <li><b>Hot:</b> Whites and heavily soiled, colorfast items.</li> <li><b>Warm:</b> Colorfast items.</li> <li><b>Cool:</b> Brightly colored, very lightly soiled items.</li> <li><b>Cold:</b> Uses only cold water without driving the heater. No warm water is supplied.</li> </ul>
<b>06</b> Rinse	<ul style="list-style-type: none"> <li>Press to specify the total number of rinses for the current cycle. Keep pressing to cycle through the rinse count options available. For more information about the options available to a specific cycle, see the <b>Cycle chart</b> on page 80.</li> </ul>

# Operations

<p><b>07 Spin</b></p>	<ul style="list-style-type: none"> <li>• <b>Extra High:</b> Extends the spinning process to effectively remove moisture from the load. Extra High uses a stronger spinning process to remove moisture, so it is not suitable for wrinklefree or non-iron fabrics, or overloads.</li> <li>• <b>High:</b> Underwear, t-shirts, jeans, and sturdy cottons.</li> <li>• <b>Medium:</b> Jeans, wrinkle-free or wash-and-wear items and synthetics.</li> <li>• <b>Low:</b> Delicate items that require a lower spinning speed.</li> <li>• <b>No Spin:</b> The drum does not spin after the final drain process.</li> <li>• <b>Rinse Hold (No lamp turns on):</b> The final rinse process is suspended so that the laundry remains in the water. To unload the laundry, run a drain or spin process.</li> </ul> <p> <b>NOTE</b></p> <p>* <b>Spin Only:</b> This cycle runs a spin cycle only. Press and hold <b>Spin</b> for 3 seconds. With the cycle time on the display, press <b>Spin</b> repeatedly until a desired spinning speed is selected. Then, press and hold <b>START/PAUSE</b> to start the cycle.</p>
<p><b>08 Soil</b></p>	<p>Press the button to select the soil level/washing time.</p> <ul style="list-style-type: none"> <li>• <b>Extra Heavy:</b> For extremely soiled loads.</li> <li>• <b>Heavy:</b> For heavily soiled loads.</li> <li>• <b>Normal:</b> For moderately soiled loads. This setting is best for most loads.</li> <li>• <b>Light:</b> For lightly soiled loads.</li> <li>• <b>Extra Light:</b> For barely soiled loads.</li> </ul>
<p><b>09 Pre Soak</b></p>	<p>This adds 30 minutes of soaking time at the start of the wash cycle for better stain removal.</p>

<p><b>10 Steam</b></p>	<p>With the Steam option selected, the washer senses the weight of the load and controls the steam effect according to the load size. This improves washing performance. Cycles available with the Steam option are: NORMAL, HEAVY DUTY, BEDDING, WHITES, and SANITIZE.</p> <ol style="list-style-type: none"> <li>1. Select a cycle. For applicable cycles, see above.</li> <li>2. Press <b>Steam</b>.</li> <li>3. Add detergent and fabric softener as instructed.</li> <li>4. Press and hold <b>START/PAUSE</b> to start the cycle.</li> </ol> <p><b>NOTE</b></p> <p>Steam may not be visible or present during the cycle, which is normal.</p>
<p><b>11 Super Speed</b></p>	<p>Press this button if you need to shorten the washing time, applicable for NORMAL, HEAVY DUTY, or BEDDING. The shortened time may differ depending on the selected cycle/load/options.</p>
<p><b>12 Delay End</b></p>	<p>You can set the washer to finish your wash automatically at a later time by choosing a delay of between 1 to 24 hours (in 1 hour increments). The hour displayed indicates the time the wash will finish.</p> <ol style="list-style-type: none"> <li>1. Select a cycle. Then, change the cycle settings if necessary.</li> <li>2. Press <b>Delay End</b> repeatedly until a desired end time is set.</li> <li>3. Press and hold <b>START/PAUSE</b>. The lamp indicator next to the Delay End button turns on with the clock running.</li> <li>4. To cancel Delay End, restart the washer by pressing <b>POWER</b>.</li> </ol> <p><b>Real-life case</b></p> <p>You want to finish a two-hour cycle 3 hours from now. To do this, you add the Delay End option to the current cycle with a 3-hour setting, and then press and hold <b>START/PAUSE</b> at 2:00 p.m. The washer starts operating at 3:00 p.m. and ends at 5:00 p.m. Provided below is the time line for this example.</p> 

# Operations

---

<b>13 Self Clean+</b>	Cleans the drum by removing dirt and mold from the drum. <ul style="list-style-type: none"><li>• Perform once every 40 washes with no detergent or bleach added.</li><li>• Make sure the drum is empty.</li><li>• Do not add any drum cleaning agents.</li></ul>
<b>14 Smart Control</b>	After connecting the lower washer to your home network using the Samsung Smart Home app, you can control the washer remotely. When started, the Smart Control indicator blinks and the front door locks. The washer enters waiting mode and waits for remote commands. For more information, visit the Samsung Smart Home page.

## Cycle overview

### Standard cycles

Cycle	Description
DELICATES	<ul style="list-style-type: none"> <li>For sheer fabrics, bras, lingerie, silks, and other handwash-only fabrics. For best performance, use liquid detergent.</li> </ul>
PERM PRESS	<ul style="list-style-type: none"> <li>For wash-and-wear, synthetic fabrics, and lightly to normally soiled items.</li> </ul>
TOWELS	<ul style="list-style-type: none"> <li>For bath towels, washcloths (facecloths) and mats.</li> </ul>
QUICK WASH	<ul style="list-style-type: none"> <li>For lightly soiled items that you want to finish washing quickly.</li> </ul>
ECO COLD	<ul style="list-style-type: none"> <li>For normally and lightly soiled items. This cycle uses only cold water to save energy. Cold water also helps prevent fabric damage.</li> </ul>
ACTIVE WEAR	<ul style="list-style-type: none"> <li>For active wear such as sports jerseys, training pants, shirts/tops, and other performance clothing. This cycle provides effective soil removal with controlled drum rotation for special fabric care.</li> </ul>
RINSE+SPIN	<ul style="list-style-type: none"> <li>For loads that need rinsing only or for loads you want to add rinse-aided fabric softener to.</li> </ul>

### Steam cycles

Cycle	Description
NORMAL	<ul style="list-style-type: none"> <li>For cottons, bed linens, table linens, underwear, towels, or shirts. The washing time and the rinse count are automatically adjusted according to the load.</li> </ul>
HEAVY DUTY	<ul style="list-style-type: none"> <li>For sturdy, colorfast fabrics and heavily soiled items.</li> </ul>
WHITES	<ul style="list-style-type: none"> <li>For white items with or without bleach.</li> </ul>
SANITIZE	<ul style="list-style-type: none"> <li>For heavily soiled, colorfast items. This cycle heats the water to 150 °F to eliminate bacteria.</li> </ul>
BEDDING	<ul style="list-style-type: none"> <li>For bulky items such as comforters, blankets, and sheets.</li> <li>For best results, wash only a single type of bedding.</li> <li>For bulky items, use liquid detergent and do not roll the items when you place them in the drum because they might get stuck.</li> </ul>



# Operations

## Simple steps to start

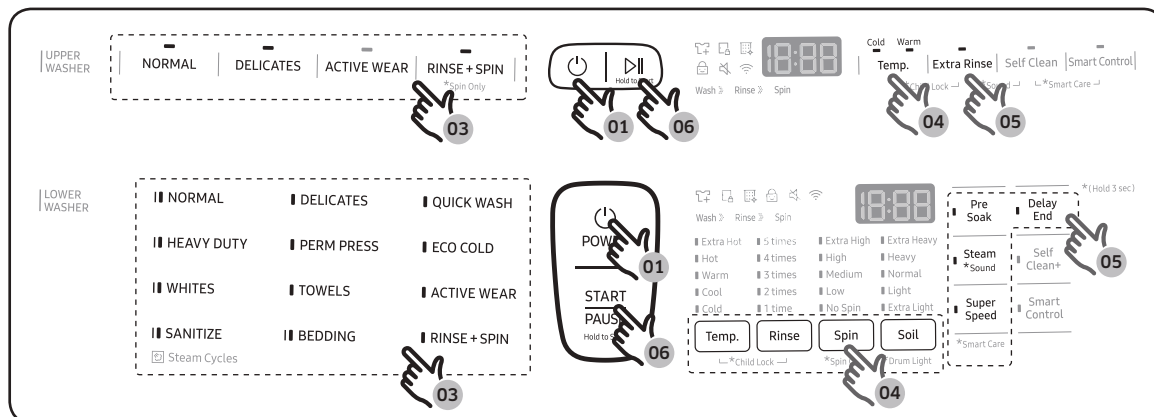

1. Press **POWER** on the control panel of a desired washer (upper/lower) to turn the washer on.
2. Put laundry into the washer.
3. Select a cycle.
4. Change the cycle settings (temperature and/or soil level) as appropriate to the laundry.
5. Select cycle options as needed.
6. Press and hold **START/PAUSE**.

### To change the cycle during operation

1. Press **START/PAUSE** to stop operations temporarily.
2. Select a different cycle.
3. Press and hold **START/PAUSE** again to start the new cycle.

### ⚠ **WARNING**

Do not put anything on top of your washer while it is running.

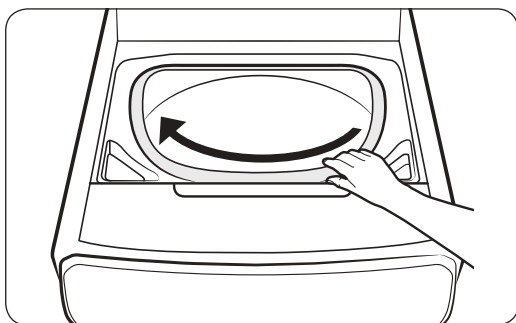

### ⚠ **CAUTION**

When using the upper washer, you may not see all the remaining clothes after a cycle is finished, especially those in the front area of the tub.

When the cycle is complete, turn the tub manually to check if there are any clothes remaining in the tub.



This product is a smart washer that supports the Samsung Smart Home service.

The amount of time the EZ setup function (for connecting the washer to your network) can take to complete the network connection varies, depending on your network conditions. For more information, visit [www.samsung.com](http://www.samsung.com).

## Samsung Smart Home

### Installation

Visit the Google Play Store, Galaxy Apps, or Apple App Store and search for “Samsung Smart Home”. Download and install the Samsung Smart Home app provided by Samsung Electronics to your smart device.

#### NOTE

- The Samsung Smart Home app is designed for Android 4.0 (ICS) or higher, or iOS 8.0 or higher, and is optimized for Samsung smartphones (Galaxy S and Galaxy Note series).
- On other devices, some functions may operate differently.
- For improved performance, the Samsung Smart Home app is subject to change without notice.

#### Registering a Samsung account

To use the Samsung Smart Home app, you must first sign in to your Samsung account. If you don't have a Samsung account, select **Register** in the app, and then follow the on-screen instructions to create an account.

#### NOTE

- If you have a registered Samsung account, log into your Samsung account. If you have a Samsung smartphone, you can go to the **Settings** menu on your smartphone, select **Accounts**, and then sign in to your Samsung account. This will allow you to log in without additional authentication.
- For third-party smart phones, the app account must be the same as the EZ Setup account.

# Operations

---

## Getting started

Using Samsung Smart Home, you can control your washer from your smart device remotely. For improved performance, the content and design of the app is subject to change without notice.

1. Launch the Samsung Smart Home App on your smartphone.
2. If 'Washer' is not listed, tap **Add Device** > **Select other device** > **Washer** on the app screen.
3. Press and hold **Smart Control** on your washer's control panel for more than 5 seconds until the 'AP' message appears on the display.
4. When the device registration is complete, turn on the Smart Control function on your washer and control your washer remotely.

---

## Special features

---

### Child Lock

To prevent children or infants from accidentally starting or setting the washer, Child Lock locks all buttons except for the **POWER** button. Note that each washer operates independently and has its own Child Lock function. If you want to activate Child Lock for the upper or lower washer, you must press the appropriate buttons on the upper or lower washer's control panel.

#### To activate Child Lock

- Press and hold **Temp.** and **Rinse** (or **Temp.** and **Extra Rinse** for the upper washer) simultaneously for 3 seconds. The door locks and the Child Lock indicator turns on. Then, press **START/PAUSE** to activate.

#### To deactivate Child Lock temporarily

- You can deactivate Child Lock temporarily for 1 minute. To do this, press and hold **Temp.** and **Rinse** (or **Temp.** and **Extra Rinse** for the upper washer) simultaneously for 3 seconds. The door is unlocked for 1 minute and the Child Lock indicator blinks.

#### NOTE

- If you open the door 1 minute or more after deactivating Child Lock, an alarm sounds for up to 2 minutes.
- If you close the door within 2 minutes, the door locks and Child Lock is reactivated. If you do not close the door or the door is not properly closed, the alarm keeps sounding for 2 minutes.
- To add laundry after activating Child Lock, first deactivate Child Lock or restart the washer.

#### To cancel Child Lock

- Press and hold **Temp.** and **Rinse** (or **Temp.** and **Extra Rinse** for the upper washer) for 3 seconds to deactivate, and then press and hold the buttons again for 3 seconds to release Child Lock. The door unlocks and the Child Lock indicator turns off.

# Operations

---

## Smart Care

The Smart Care function helps you diagnose and troubleshoot your washer if it has an issue. To enable this function, you must first download the Samsung Smart Washer app from the Play Store or the Apple Store, and install it on a mobile device that has a built-in camera. The Smart Care function has been optimized for: Galaxy and iPhone series devices. (It is not supported by some models.)

As the washer operates, it runs self-diagnosis in the background. If it senses an issue to check, it displays an information code on the display which you can scan using the app's Smart Care function, which then displays detailed information about the code for your reference.

1. Press and hold **Super Speed** (or **Self Clean** and **Smart Control** for the upper washer) on the washer for 3 seconds to enter the Smart Care mode.
2. Run the Samsung Smart Washer app on your mobile device, and then tap **Smart Care**.
3. Hold the mobile device so that the mobile device and the washer's status bar face each other. The app will recognize the information code automatically.
4. When the information code is recognized correctly, the app provides detailed information about the symptom and recommends further action.

### NOTE

- The function name, Smart Care, may differ depending on your language.
- If the washer display is reflecting light, the app may fail to recognize the information code.
- If the app fails to recognize the information code a number of times consecutively, enter the information code manually into the app screen.
- The information code history stored in the washer will be deleted after you use this function.

---

## Sound

Mute or unmute the sound (button beeps, indicator beeps, and chimes, etc.)

### Upper washer

- To mute the alarm sound or beep on the upper washer, press and hold **Extra Rinse** and **Self Clean** for 3 seconds. To unmute, press and hold the buttons for 3 seconds again.

### Lower washer

- To mute the alarm sound or beep on the lower washer, press and hold **Steam** for 3 seconds. To unmute, press and hold the button for 3 seconds again.

## Drum Light (lower washer only)

The drum light turns on when the door is opened, and turns off after 2 minutes. To manually turn the drum light on or off, press and hold **Soil** for 3 seconds.

## ATC (Auto Temperature Control)

ATC enables the washer to control water temperatures in each washing cycle using the washer's internal thermistor. It is designed to maintain certain washing temperatures for best results.

- If you select NORMAL or HEAVY DUTY, you may notice the washer supplying cold water. This is normal because the washer is designed to reduce power consumption.
- In these cycles, the Hot temperature is similar to bath-water temperatures and the Warm temperature to comfortable swimming pool temperatures.
- To wash laundry at a specific temperature, you must choose a different cycle first.

# Maintenance

---

Keep the washer clean to prevent its performance from deteriorating and to preserve its life cycle.

## **WARNING**

Control board, heat sink, motor, inlet valve and pump are intentionally not grounded and may present a risk of electric shock only during servicing.

## General considerations

---

### Cleaning

#### Surface of the washer

Use a soft cloth with a nonabrasive household detergent. Do not spray water onto the washer.

#### Exterior

1. Turn off the water taps after finishing the day's washing.  
This will shut off the water supply to your washer and prevent the unlikely possibility of damage from escaping water. Leave the door open to allow the inside of your washer to dry out.
2. Use a soft cloth to wipe up all detergent, bleach, or other spills as they occur.  
Clean the following as recommended below:
  - Control panels - Clean with a soft, damp cloth. Do not use abrasive powders or cleaning pads. Do not spray cleaners directly on the panels.
  - Cabinet - Clean with soap and water.

#### Interior

Clean the interior of your washer periodically to remove any dirt, soil, odor, mold, mildew, or bacterial residue that may remain in your washer as a result of washing clothes.

## **CAUTION**

Failure to follow these instructions may result in unpleasant conditions, including odors and/or permanent stains on your washer or laundry.

## **NOTE**

Hard water deposits may be removed, if needed. Use a cleaner labeled "Washer safe".

## Mesh filter

Clean the mesh filter of the water hose once or twice a year.

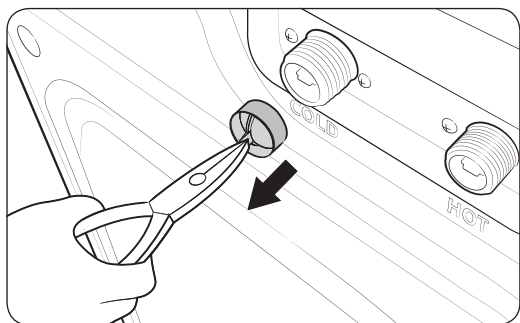
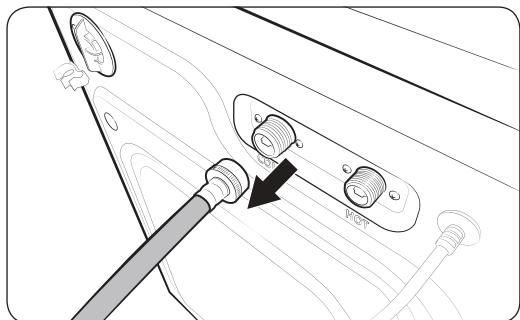

1. Turn off the washer, and then unplug the power cord.
2. Close the taps.
3. Loosen and disconnect the water hose from the back of the washer. Cover the hose with a cloth to prevent water from gushing out.
4. Use pliers to pull out the mesh filter from the inlet valve.
5. Submerge the mesh filter deeply in water so that the threaded connector is also submerged.
6. Dry the mesh filter completely in a shaded area.
7. Reinsert the mesh filter into the inlet valve, and reconnect the water hose to the inlet valve.
8. Open the tap.

### NOTE

If the mesh filter is clogged, the “4C” information code appears on the the washer’s display.



# Maintenance

---

## Recovery from freezing

The washer may freeze when the temperature in its location drops below 32 °F (0 °C).

1. Turn off the washer, and then unplug the power cord.
2. Pour warm water over the tap to loosen the water hose.
3. Disconnect the water hose, and soak it in warm water.
4. Pour warm water into the drum (tub) and leave it for about 10 minutes.
5. Reconnect the water hose to the tap.

### **NOTE**

If the washer still doesn't operate normally, repeat the steps above until it operates normally.

## If the washer will not be used for an extended period of time

Avoid leaving the washer unused for an extended time. If you intend to leave the washer unused for a long period of time, follow the directions below:

1. Press **POWER**, and then select **RINSE+SPIN**.
2. Empty both the drum and the tub, close the door, and then press **START/PAUSE**.
3. When the cycle is complete, close the tap and disconnect the water hoses.
4. Turn off the washer, and then unplug the power cord.
5. Open the doors to let air circulate through the drum and the tub.

## Upper washer

### Self Clean

Self Clean is a self-cleaning cycle that removes dirt and bacteria that may occur inside the tub. We recommend running Self Clean every 20 washes.

1. Make sure the tub is empty.
2. Press **POWER**.
3. Press **Self Clean**.
4. Press and hold **START/PAUSE**.

#### **CAUTION**

- With Self Clean, you can clean the tub without using detergent or bleach.
- Only use Self Clean when the tub is empty. This may cause damage to the laundry or a problem with the washer.

#### Self Clean reminder

- The Self Clean+ reminder  appears on the main display once every 20 washes. We strongly recommend that you perform the Self Clean+ regularly. Remove the laundry from the washer, turn the washer on, and clean the tub by running Self Clean.
- If you do not run Self Clean, the Self Clean indicator turns off. However, the indicator will light again after five washes. Not running Self Clean at this point will not cause a problem with the washer. However, we strongly recommend running Self Clean at this point.
- Although the Self Clean indicator turns on once a month or so, the frequency may differ depending on the number of times the washer is used.

### Fabric softener/bleach compartment

Both the fabric softener compartment and the bleach compartment on the upper washer are not removable by design to facilitate visual feedback to users. To clean the softener compartment, follow these instructions. Cleaning the bleach compartment is basically the same.

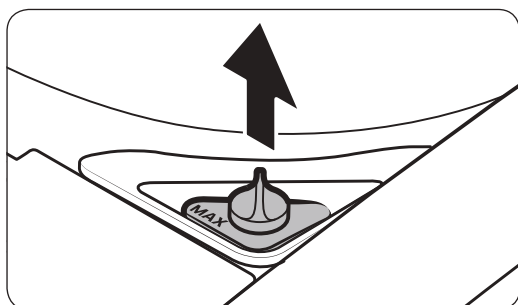

1. Open the top door, and then remove the softener cap.

# Maintenance

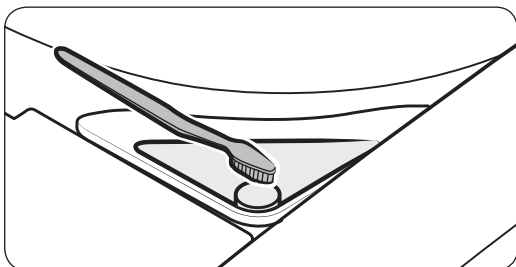

2. Use a soft brush (for example, a toothbrush) to clean inside the compartment and remove impurities.
3. Run the RINSE+SPIN cycle to rinse the compartment. After supplying water and draining 5 times, the 18-minute cycle completes with the final spin process.

## Lint filter

We recommend cleaning the lint filter every 10 washes.

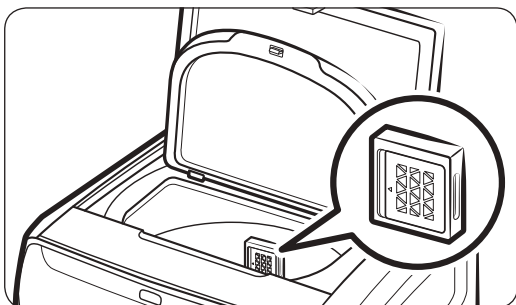

1. Remove the lint filter from the filter case on the tub of the upper washer.

### NOTE

It is recommended to use a coin or a thin metal object to remove and open the lint filter.

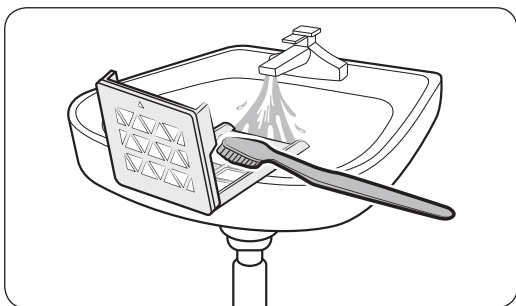
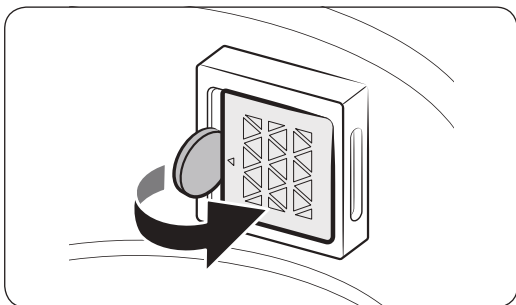

2. Open the filter, and clean it with running water and a brush.
3. When cleaning is complete, close the filter and reinsert it in its original position. You will hear a clicking sound when the filter is inserted correctly.

---

## Lower washer

---

### Self Clean+

Perform this cycle regularly to clean the drum and to remove mold from it.

1. Make sure the drum is empty.
2. Press **POWER** to turn on the washer.
3. Press **Self Clean+**.
4. Press and hold **START/PAUSE**.

#### **CAUTION**

- Do not use any cleaning agents. Do not add detergent or bleach. Chemical residue in the drum degrades the cleaning performance.
- Only use Self Clean+ when the drum is empty. Do not use Self Clean+ if the drum contains laundry. This may cause damage to the laundry or a problem with the washer.

#### **NOTE**

The water temperature for Self Clean+ is set to Extra Hot, which cannot be changed.

#### Self Clean+ reminder (🔔)

- The Self Clean+ reminder (🔔) appears on the main display once every 40 washes. We strongly recommend that you perform the Self Clean+ regularly.
- If you do not run Self Clean+ after every 40 washes, the Self Clean+ reminder turns off after one hour.
- When you first see this reminder, you can ignore the reminder for 6 consecutive washes. From the 7<sup>th</sup> wash, the reminder no longer appears. However, it appears again after the second batch of 40 washes.

# Maintenance

## Main wash compartment

The main wash compartment needs to be cleaned periodically to remove buildup of laundry additives.

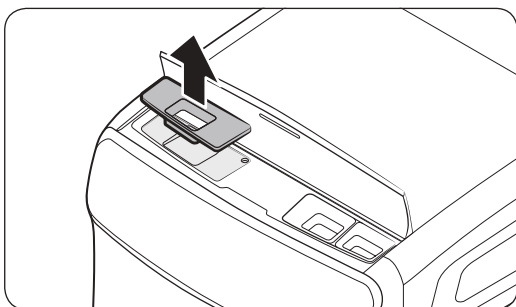

1. Open the top-front cover. Grasp the main wash compartment, and then pull up to remove.

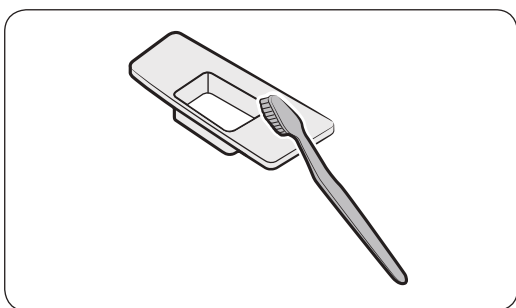

2. Remove all residue and traces of accumulated laundry agents from the compartment. Rinse it with warm water.

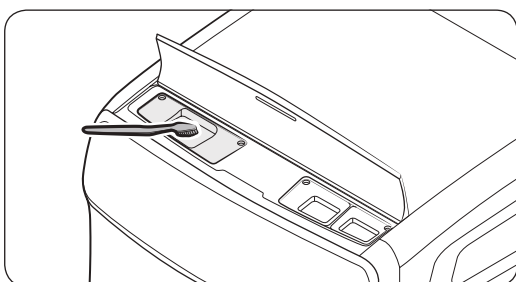

3. To clean the recess of the compartment, use a small, non-metal brush. Remove all residue from all sides of the recess.
4. Reinsert the compartment into place.

## Fabric softener/bleach compartment

Both the fabric softener compartment and the bleach compartment on the lower washer are not removable by design to facilitate visual feedback to users. To clean the softener compartment, follow these instructions. Cleaning the bleach compartment is basically the same.

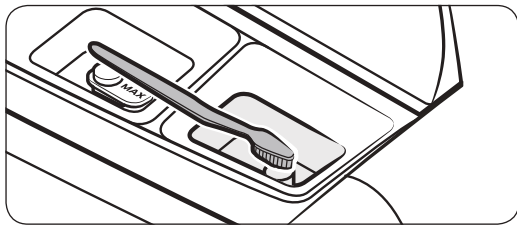
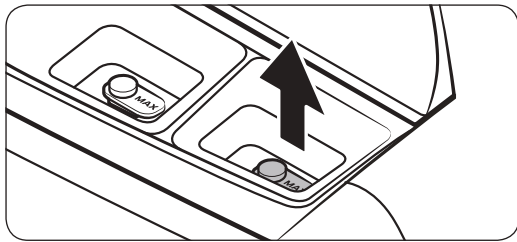

1. Open the top-front cover, and then remove the softener cap.
2. Use a soft brush (for example, a toothbrush) to clean inside the compartment and remove impurities.
3. Run the RINSE+SPIN cycle to rinse the compartment. After supplying water and draining 5 times, the 19-minute cycle completes with the final spin process.

## Door diaphragm

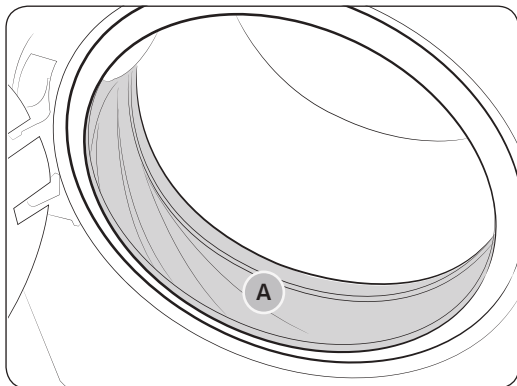

1. Open the door and empty the drum.
2. Turn out the diaphragm (sealing or gasket of the drum **(A)**), and check if it is stained. If so, follow the steps below.
3. Combine 3/4 cups of liquid chlorine bleach and 1 gallon of warm tap water.
4. Wearing rubber gloves, use a soft, clean cloth dipped in the water and chlorine solution to clean the diaphragm.
5. Let stand for 5 minutes, and then wipe up and dry well.

### ⚠ CAUTION

Use bleach carefully and be sure to follow the bleach manufacturer's use and care instructions.

# Maintenance

## Emergency drain

In case of a power failure, drain the water inside the drum before taking out the laundry.

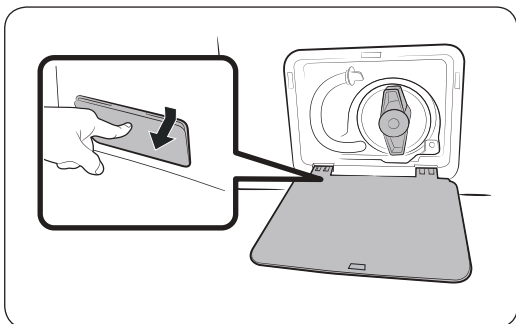

1. Power off the washer, and then unplug it from the electrical outlet.
2. Gently press the top area of the filter cover to open.

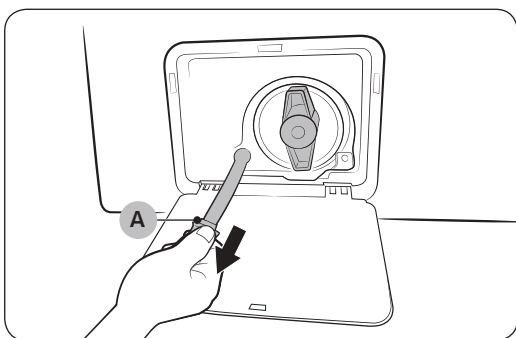

3. Put an empty, spacious container in front of the cover, and stretch the emergency drain tube to the container while holding the **tube cap (A)**.

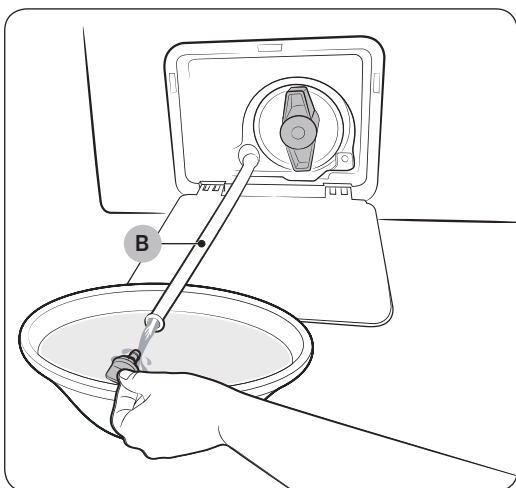

4. Open the tube cap and let water in the **Emergency drain tube (B)** flow into the container.
5. When done, close the tube cap, and reinsert the tube. Then, close the filter cover.

### **NOTE**

Use a spacious container because the water in the drum may be more than expected.

## Pump filter

It is advisable to clean the pump filter 5 or 6 times a year to prevent it from clogging. A clogged pump filter may reduce the bubble effect.

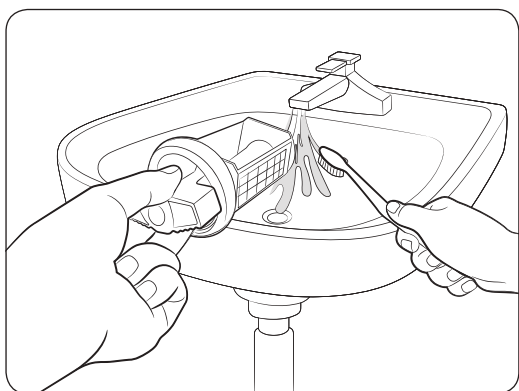
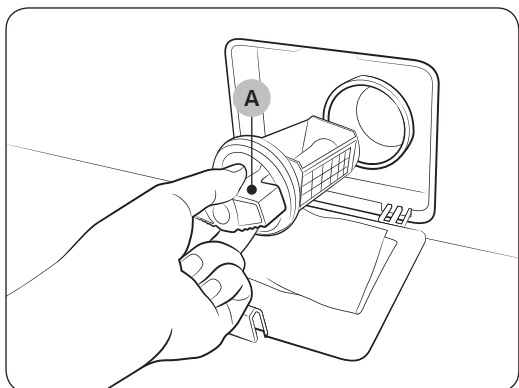

1. Turn off the washer, and then unplug the power cord.
2. Drain the remaining water inside the drum. See the **Emergency drain** section on page 64.
3. Gently press the top area of the filter cover to open.
4. Turn the **pump filter knob (A)** to the left, and drain off the remaining water.
5. Clean the pump filter using a soft brush. Make sure the drain pump propeller inside the filter is not clogged.
6. Reinsert the pump filter, and then turn the filter knob to the right.
7. Close the filter cover.



# Maintenance

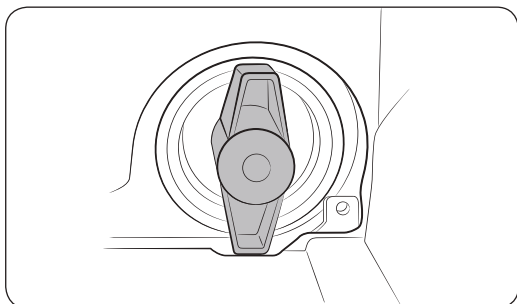

## NOTE

- Some pump filters feature a safety knob that is designed to prevent children from accidentally opening the filter compartment. To open the safety knob of the pump filter, push in and turn it counterclockwise. The spring mechanism of the safety knob helps open the filter.
- To close the safety knob of the pump filter, turn it clockwise. The spring makes a rattling sound, which is normal.

## NOTE

If the pump filter is clogged, the “5C” information code appears on the washer’s display screen.

## CAUTION

- Make sure the filter knob is closed properly after cleaning the filter. Otherwise, this may cause a leak.
- Make sure the filter is inserted properly after cleaning it. Otherwise, this may cause an operational failure or a leak.

# Troubleshooting

## Checkpoints

If you encounter an issue to check with the washer, first check the table below and try the suggestions.

Symptom	Action
Does not turn on.	<ul style="list-style-type: none"><li>• Make sure your home electrical system is providing electrical power that matches the requirements of the washer. See page 21.</li><li>• Make sure the power plug of the washer is completely plugged in.</li></ul>
Does not start.	<ul style="list-style-type: none"><li>• Make sure the door is properly closed.</li><li>• Make sure the taps are open.</li><li>• Make sure to press and hold <b>START/PAUSE</b> to start the washer.</li><li>• Make sure <b>Child Lock</b> is not activated.</li><li>• Before the washer starts to fill, it will make a series of clicking noises to check the door lock and does a quick drain.</li><li>• Check the fuse or reset the circuit breaker.</li><li>• Check if the upper or lower washer displays an information code on the respective status bar.</li></ul>
Water supply is insufficient or no water is supplied.	<ul style="list-style-type: none"><li>• Fully open the tap.</li><li>• Make sure the door is properly closed.</li><li>• Make sure the water supply hose is not frozen.</li><li>• Make sure the water supply hose is not kinked or clogged.</li><li>• Make sure there is sufficient water pressure.</li></ul>
After a cycle, detergent remains in the detergent drawer.	<ul style="list-style-type: none"><li>• Make sure the washer is running with sufficient water pressure.</li><li>• If you are using powdered detergent, do not use more than recommended.</li><li>• If you are using liquid detergent, do not over fill the liquid detergent compartment.</li><li>• Remove the liquid detergent and softener containers, and then clean the detergent drawer.</li></ul>

# Troubleshooting

Symptom	Action
Excessive vibrations or makes noise.	<ul style="list-style-type: none"> <li>• Make sure the washer is installed on a level, solid floor that is not slippery. If the floor is not level, use the levelling feet to adjust the height of the washer.</li> <li>• Make sure the shipping bolts are removed.</li> <li>• Make sure the washer is not contacting any other object.</li> <li>• Make sure the laundry load is balanced.</li> <li>• The motor can cause noise during normal operation.</li> <li>• Overalls or metal-decorated clothes can cause noise while being washed. This is normal.</li> <li>• Metal objects such as coins can cause noise. After washing, remove these objects from the drum or tub or filter case.</li> </ul>
Does not drain and/or spin.	<ul style="list-style-type: none"> <li>• Make sure the drain hose is neither kinked nor obstructed all the way to the drain system. If there is a drain restriction, call for service.</li> <li>• Make sure the debris filter is not clogged.</li> <li>• Close the door and press and hold <b>START/PAUSE</b>. For your safety, the washer will not tumble or spin unless the door is closed.</li> <li>• Make sure the drain hose is not frozen or clogged.</li> <li>• Make sure the drain hose is connected to a drain system that is not clogged.</li> <li>• If the washer is not supplied with sufficient power, the washer temporarily will not drain or spin. As soon as the washer regains sufficient power, it will operate normally.</li> </ul>
Drains with noise.	<ul style="list-style-type: none"> <li>• At the initial installation, or when the washer has not been used for an extended period of time, the washer may make deflating noises while draining. This is not a system failure.</li> </ul>
The door does not open.	<ul style="list-style-type: none"> <li>• Press <b>START/PAUSE</b> to stop the washer.</li> <li>• It may take a few moments for the door lock mechanism to disengage.</li> <li>• The door will not open until 3 minutes after the washer has stopped or the power has been turned off.</li> <li>• Make sure all the water in the drum or tub is drained.</li> <li>• The door may not open if water remains in the drum or tub. Drain the drum or tub and open the door manually.</li> <li>• Make sure the door lock light is off. The door lock light turns off after the washer has drained.</li> </ul>

Symptom	Action
Excessive suds.	<ul style="list-style-type: none"> <li>• Make sure you use the recommended types of detergent.</li> <li>• Use high efficiency (HE) detergent to prevent oversudsing.</li> <li>• Reduce the detergent amount for soft water, small loads, or lightly soiled loads.</li> <li>• Non-HE detergent is not recommended.</li> </ul>
Cannot add additional detergent.	<ul style="list-style-type: none"> <li>• Do not fill the detergent or fabric softener compartments beyond the marked max fill limit.</li> </ul>
The washer stops.	<ul style="list-style-type: none"> <li>• Plug the power cord into a live electrical outlet.</li> <li>• Check the fuse or reset the circuit breaker.</li> <li>• Close the door, and then press and hold <b>START/PAUSE</b> to start the washer. For your safety, the washer will not tumble or spin unless the door is closed.</li> <li>• Before the washer starts to fill, it will make a series of clicking noises to check the door lock and does a quick drain.</li> <li>• There may be a pause or soak period in the cycle. Wait and the washer may start.</li> <li>• Make sure the mesh filters of the water supply hoses at the taps are not clogged. Periodically clean the mesh filters.</li> <li>• If the washer is not supplied with sufficient power, the washer temporarily will not drain or spin. As soon as the washer regains sufficient power, it will operate normally.</li> </ul>

# Troubleshooting

Symptom	Action
The washer fills with the wrong temperature water.	<ul style="list-style-type: none"> <li>• Fully open both taps.</li> <li>• Make sure the temperature selection is correct.</li> <li>• Make sure the hoses are connected to the correct taps. Flush the water lines.</li> <li>• Make sure your water heater is set to supply hot water with a minimum temperature of 120 °F (49 °C) at the tap. Also, check the water heater capacity and recovery rate.</li> <li>• Disconnect the hoses and clean the mesh filters. The mesh filters may be clogged.</li> <li>• While the washer fills, the water temperature may change as the automatic temperature control feature checks the incoming water temperature. This is normal.</li> <li>• While the washer fills, you may notice just hot and/or just cold water going through the dispenser when cold or warm temperatures are selected. This is a normal function of the automatic temperature control feature as the washer determines the water temperature.</li> </ul>
The load is wet at the end of a cycle.	<ul style="list-style-type: none"> <li>• Use the High or Extra High spin speed.</li> <li>• Use high efficiency (HE) detergent to reduce oversudsing.</li> <li>• The load is too small. Small loads (one or two items) may become unbalanced and not spin completely.</li> <li>• Make sure the drain hose is not kinked or clogged.</li> </ul>
Leaks water.	<ul style="list-style-type: none"> <li>• Make sure the door is properly closed.</li> <li>• Make sure all hose connections are tight.</li> <li>• Make sure the end of the drain hose is correctly inserted and secured to the drain system.</li> <li>• Avoid overloading.</li> <li>• Use high efficiency (HE) detergent to prevent oversudsing.</li> </ul>
Has odors.	<ul style="list-style-type: none"> <li>• Excessive suds collect in recesses and can cause foul odors.</li> <li>• Run cleansing cycles to sanitize periodically.</li> <li>• Clean the door seal (diaphragm).</li> <li>• Dry the washer interior after a cycle has finished.</li> </ul>

Symptom	Action
The tub or the water/drain hose is frozen.	<ul style="list-style-type: none"> <li>• For frozen hoses, use warm water to disconnect the frozen hoses. Soak them in warm water.</li> <li>• For a frozen tub, fill the tub with warm water, and then wait for about 10 minutes.</li> <li>• For the hose connector, put a hot towel on the drain hose connector.</li> <li>• After thawing the hoses, reconnect them.</li> </ul>
Water drains out immediately.	<ul style="list-style-type: none"> <li>• Make sure the drain hose is not clogged, and is hung over the drain hose hook. Fill the tub halfway with water, and try spinning again.</li> <li>• Lift the end of the drain hose to prevent water from draining. Fill the tub halfway with water, and then run the spin cycle after releasing the drain hose.</li> <li>• Make sure the drain hose is installed correctly. See the installation section of this manual and then adjust the position of the drain hose as instructed.</li> </ul>

If an issue continues to occur, contact a local Samsung service center.

# Troubleshooting

## Samsung Smart Home

Problem	Action
I could not find “Samsung Smart Home” in the app market.	<ul style="list-style-type: none"><li>• The Samsung Smart Home app is available for smartphones that run Android 4.0 (ICS) or higher, or iOS 7.0 or higher.</li></ul>
The Samsung Smart Home app fails to operate.	<ul style="list-style-type: none"><li>• The Samsung Smart Home app is available for applicable models only.</li><li>• The old Samsung Smart Washer app cannot connect with Samsung Smart Home models.</li></ul>
The Samsung Smart Home app is installed but is not connected to my washer.	<ul style="list-style-type: none"><li>• You must log into your Samsung account to use the app.</li><li>• Make sure that your router is operating normally.</li><li>• If the Smart Control indicator  on the washer’s display is off, this indicates that no network connection has been established. Use the Samsung Smart Home app to connect and register the washer with your home network access point (AP).</li></ul>
Could not log into the app.	<ul style="list-style-type: none"><li>• You must log into your Samsung account to use the app.</li><li>• If you don’t have a Samsung account, follow the app’s onscreen instructions to create one.</li></ul>
An error message appears when I try to register my washer.	<ul style="list-style-type: none"><li>• The connection may fail due to the distance from your access point (AP) or electrical interference from the surrounding environment. Wait a moment and try again.</li></ul>
The Samsung Smart Home app is successfully connected to my washer but does not run.	<ul style="list-style-type: none"><li>• Exit and restart the Samsung Smart Home app or unplug your router and then reconnect it.</li></ul>

## Information codes

If the washer fails to operate, you may see an information code on the screen. Check the table below and try the suggestions.

Code		Action
Upper washer	Lower washer	
1 1C	1C	<b>Check the water level sensor.</b> <ul style="list-style-type: none"><li>Power off and then power the washer on after 2-3 minutes, and then try again.</li><li>Depending on the model, the drain system drains water automatically. The <b>POWER</b> and <b>START/PAUSE</b> buttons may be disabled during this process.</li></ul>
-	DC	<b>The door is open.</b> <ul style="list-style-type: none"><li>Close the door, and then press <b>START/PAUSE</b> to resume operation.</li></ul>
1 DC	-	<b>The top door is open.</b> <ul style="list-style-type: none"><li>Close the top door, and then press <b>START/PAUSE</b> to resume operation.</li></ul>
1 DC4	-	<b>The protective cover is open.</b> <ul style="list-style-type: none"><li>Close the protective cover, and then press <b>START/PAUSE</b> to resume operation.</li></ul>
1 DC1	DC1	<b>Check the door switch.</b> <ul style="list-style-type: none"><li>Power off and then power the washer on after 2-3 minutes, and then try again.</li></ul>
1 LC	LC	<b>Check for water leaks.</b> <ul style="list-style-type: none"><li>Power the washer off, and then check the drain system for any leaks. Once the leak issue is resolved, power the washer on after 2-3 minutes.</li><li>Depending on the model, the drain system drains water automatically. The <b>POWER</b> and <b>START/PAUSE</b> buttons may be disabled during this process.</li></ul>



# Troubleshooting

Code		Action
Upper washer	Lower washer	
1 LC1	LC1	<p><b>Check the drain hose.</b></p> <ul style="list-style-type: none"> <li>• Make sure the end of the drain hose is placed on the floor.</li> <li>• Make sure the drain hose is not clogged.</li> <li>• If the information code remains, contact a customer service centre.</li> </ul> <p><b>Others</b></p> <ul style="list-style-type: none"> <li>• Use caution not to overfill any of the compartments (main wash/fabric softener/bleach).</li> <li>• Do not spray or use water when cleaning the top door of the upper washer. Use a cloth to wipe up.</li> </ul>
1 4C	4C	<p><b>Check the water supply line.</b></p> <ul style="list-style-type: none"> <li>• Check the connection to the water line (including water taps).</li> <li>• Power off and then power the washer on after 2-3 minutes, and then try again.</li> <li>• Depending on the model, the drain system drains water automatically. The <b>POWER</b> and <b>START/PAUSE</b> buttons may be disabled during this process.</li> </ul>
1 4C2	4C2	<p><b>The water being supplied is too hot.</b></p> <ul style="list-style-type: none"> <li>• Make sure the cold and hot water taps are properly connected.</li> <li>• Power off and then power the washer on after 2-3 minutes, and then try again.</li> </ul>
1 5C	5C	<p><b>Check the drain system.</b></p> <ul style="list-style-type: none"> <li>• Make sure the drain filter is not clogged.</li> <li>• If the drain filter is clogged, clean the filter, and then restart the washer.</li> </ul>
1 HC	HC	<p><b>Check the washing heater.</b></p> <ul style="list-style-type: none"> <li>• Power off the washer, and then contact a Samsung customer service center.</li> </ul>

Code		Action
Upper washer	Lower washer	
1 UB	UB	<p><b>Check the spinning process.</b></p> <ul style="list-style-type: none"> <li>The load may not be balanced inside the drum or tub. Load is too small, or heavy items are mixed with light items. Check the drum or tub and make sure the load is balanced.</li> <li>Avoid washing single items, adding few extra items help to balance the load. Redistribute the load evenly.</li> <li>Press <b>START/PAUSE</b> to resume operation, or power off and then power the washer on after 2-3 minutes, and then try again.</li> </ul>
1 8C 1 8C1 1 8C2	8C 8C1 8C2	<p><b>Check the MEMS sensor.</b></p> <ul style="list-style-type: none"> <li>Power off and then power the washer on after 2-3 minutes, and then try again.</li> </ul>
1 OC	OC	<p><b>Water may overflow.</b></p> <ul style="list-style-type: none"> <li>Close the water tap, and then call for service.</li> </ul>
1 3C	3C	<p><b>Check the motor.</b></p> <ul style="list-style-type: none"> <li>Power off and then power the washer on after 2-3 minutes, and then try again.</li> </ul>
1 AC6	AC6	<p><b>Check the PBA communication status.</b></p> <ul style="list-style-type: none"> <li>Power off and then power the washer on after 2-3 minutes, and then try again.</li> </ul>
1 9C1 1 9C2	9C1 9C2	<p><b>The electronic control needs to be checked.</b></p> <ul style="list-style-type: none"> <li>Check if power is supplied properly.</li> <li>If the information code remains, contact a Samsung service center.</li> </ul>
1 SF	SF	<p><b>System failed.</b></p> <ul style="list-style-type: none"> <li>Power off the washer, and then contact a Samsung service center.</li> </ul>
1 AC	AC	<p><b>Check communications between main and sub PBAs.</b></p> <ul style="list-style-type: none"> <li>Try powering off and restarting the cycle.</li> <li>If the information code remains, contact a customer service center.</li> </ul>

# Troubleshooting

---

Code		Action
Upper washer	Lower washer	
-	AC7	<p>Check communications between the lower main PBA and the upper main PBA.</p> <ul style="list-style-type: none"><li>• Try powering off and restarting the cycle.</li><li>• If the information code remains, contact a customer service center.</li></ul>





If any information code keeps appearing on the screen, contact a local Samsung service center.

# Specifications

## Fabric care chart

The following symbols provide garment care direction. The clothing care labels include symbols for drying, bleaching, drying and ironing, or dry cleaning when necessary. The use of symbols ensures consistency among garment manufacturers of domestic and imported items. Follow care label directions to optimize garment life and reduce laundering problems.

### Wash cycle

	Normal
	Permanent press / Wrinkle resistant / Wrinkle control
	Gentle / Delicates
	Hand wash



### Water temperature

...	Hot
..	Warm
.	Cold



### NOTE

The temperature range for Hot is 135 °F (57 °C) or below, 95 °F (35 °C) or below for Warm, and 68 °F (20 °C) or below for Cold. Wash water temperature must be a minimum of 60 °F (16 °C) for detergent activation and effective cleaning.



### Bleach

	Any bleach (when needed)
	Only non-chlorine (color-safe) bleach (when needed)
	Tumble dry





### Normal

	Permanent press / Wrinkle resistant / Wrinkle control
	Gentle/Delicates

### Special instructions



	Line dry/Hang to dry
	Drip dry
	Dry flat

### Heat setting





	High
	Medium
	Low
	Any heat
	No heat / Air



# Specifications

## Iron dry or steam temperatures





	High
	Medium
	Low

## Warning symbols for laundering

	Do not wash
	Do not wring
	Do not bleach
	Do not tumble dry

	No steam (added to iron)
	Do not iron

## Dry-clean

	Dry-clean
	Do not dry-clean
	Line dry / Hang to dry
	Drip dry
	Dry flat

## Protecting the environment

- This appliance is manufactured from recyclable materials. If you decide to dispose of it, please observe local waste disposal regulations. Cut off the power cord so that the appliance cannot be connected to a power source. Remove the lid so that animals and small children cannot get trapped inside the appliance.
- Do not exceed the detergent quantities recommended in the detergent manufacturers' instructions.
- Use stain removal products and bleaches before the wash cycle only when necessary.
- Save water and electricity by only washing full loads (the exact amount depends upon the program used).

## Declaration of conformity

This appliance complies with UL2157.

## Specification sheet

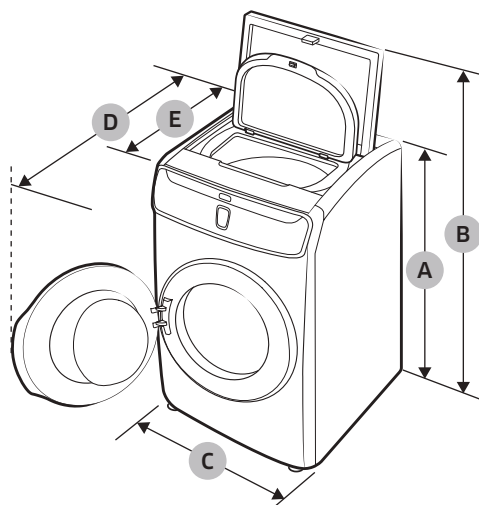

Type		Dual loading washer	
Dimensions (inches (mm))	A. Height - top door closed	46.9 in. (1192 mm)	
	B. Height - top door opened	61 in. (1550 mm)	
	C. Width	27 in. (686 mm)	
	D. Depth with door open	54.2 in. (1377 mm)	
	E. Depth	34 in. (864 mm)	
Water pressure (psi (kPa))		20 - 116 (137 - 800)	
NET weight (lb (kg))		308.6 (140)	
Spin revolution	Upper washer	800 rpm	
	Lower washer	1300 rpm	
Heater rating	Washing and heating	120 V	900 W

# Specifications

## Cycle chart

Use this chart to set the best cycle and options for you laundry.

### Upper washer

 **NOTE**

Setting	Temp.
●: factory setting	W : Warm
●: can be selected	C : Cold

Cycle	Functions		Options
	Temp.		Extra Rinse
	W	C	
NORMAL	●	●	●
DELICATES	●	●	
ACTIVE WEAR	●	●	●
RINSE+SPIN			●

## Lower washer

### NOTE

Setting	Temp.	Rinse	Spin	Soil Level
●: factory setting	EH : Extra hot	5 : 5 times	EH : Extra High	EH : Extra Heavy
●: can be selected	H : Hot	4 : 4 times	H : High	H : Heavy
	W : Warm	3 : 3 times	M : Medium	N : Normal
	CL : Cool	2 : 2 times	L : Low	L : Light
	CD : Cold	1 : 1 times	NS : No Spin	EL : Extra Light

Cycle	Functions														
	Temp.					Rinse					Spin				
	EH	H	W	CL	CD	5	4	3	2	1	EH	H	M	L	NS
NORMAL	●	●	●	●	●	●	●	●	●	●	●	●	●	●	●
HEAVY DUTY	●	●	●	●	●	●	●	●	●	●	●	●	●	●	●
BEDDING			●	●	●	●	●	●	●	●			●	●	●
WHITES		●	●	●	●	●	●	●	●	●	●	●	●	●	●
SANITIZE	●					●	●	●	●	●	●	●	●	●	●
RINSE+SPIN						●	●	●	●	●	●	●	●	●	●
ACTIVE WEAR			●	●	●	●	●	●	●	●				●	●
DELICATES			●	●	●			●	●	●				●	●
PERM PRESS			●	●	●	●	●	●	●	●		●	●	●	●
QUICK WASH		●	●	●	●	●	●	●	●	●	●	●	●	●	●
ECO COLD				●	●	●	●	●	●	●	●	●	●	●	●
TOWELS		●	●	●	●	●	●	●	●	●	●	●	●	●	●
Self clean+	●								●		●				



# Specifications

Cycle	Functions					Options			
	Soil Level					Pre Soak	Steam	Super Speed	Delay End
	EH	H	N	L	EL				
NORMAL	●	●	●	●	●	●	●	●	●
HEAVY DUTY	●	●	●	●	●	●	●	●	●
BEDDING	●	●	●	●	●	●	●	●	●
WHITES	●	●	●	●	●	●	●		●
SANITIZE	●	●	●	●	●	●	●		●
RINSE+SPIN									●
ACTIVE WEAR	●	●	●	●	●	●			●
DELICATES	●	●	●	●	●				●
PERM PRESS	●	●	●	●	●	●			●
QUICK WASH	●	●	●	●	●				●
ECO COLD	●	●	●	●	●	●			●
TOWELS	●	●	●	●	●				●
Self clean+									●

# Warranty (U.S.A)

---

## SAMSUNG WASHER

---

### LIMITED WARRANTY TO ORIGINAL PURCHASER

This SAMSUNG brand product, as supplied and distributed by SAMSUNG ELECTRONICS AMERICA, INC. (SAMSUNG) and delivered new, in the original carton to the original consumer purchaser, is warranted by SAMSUNG against manufacturing defects in materials and workmanship for a limited warranty period of:

One (1) year part and labor, Three (3) years stainless tub part (Part Only), Ten (10) years washing DD motor part (Part Only)

This limited warranty begins on the original date of purchase, and is valid only on products purchased and used in the United States. To receive warranty service, the purchaser must contact SAMSUNG for problem determination and service procedures. Warranty service can only be performed by a SAMSUNG authorized service center. The original dated bill of sale must be presented upon request as proof of purchase to SAMSUNG or SAMSUNG's authorized service center. SAMSUNG will provide in-home service during the warranty period at no charge, subject to availability within the contiguous United States. In-home service is not available in all areas.

To receive in-home service, product must be unobstructed and accessible to the service agent. If service is not available, SAMSUNG may elect to provide transportation of the product to and from an authorized service center.

# Warranty (U.S.A)

---

SAMSUNG will repair, replace, or refund this product at our option and at no charge as stipulated herein, with new or reconditioned parts or products if found to be defective during the limited warranty period specified above. All replaced parts and products become the property of SAMSUNG and must be returned to SAMSUNG. Replacement parts and products assume the remaining original warranty, or ninety (90) days, whichever is longer. This limited warranty covers manufacturing defects in materials and workmanship encountered in normal, noncommercial use of this product and shall not apply to the following: damage that occurs in shipment; delivery and installation; applications and uses for which this product was not intended; altered product or serial numbers; cosmetic damage or exterior finish; accidents, abuse, neglect, fire, water, lightning, or other acts of nature or God; use of products, equipment, systems, utilities, services, parts, supplies, accessories, applications, installations, repairs, external wiring or connectors not supplied or authorized by SAMSUNG that damage this product or result in service problems; incorrect electrical line voltage, fluctuations and surges; customer adjustments and failure to follow operating instructions, maintenance and environmental instructions that are covered and prescribed in the instruction book; product removal and reinstallation; problems caused by pest infestations. This limited warranty does not cover problems resulting from incorrect electric current, voltage or supply, light bulbs, house fuses, house wiring, cost of a service call for instructions, or fixing installation errors. SAMSUNG does not warrant uninterrupted or error-free operation of the product.

EXCEPT AS SET FORTH HEREIN, THERE ARE NO WARRANTIES ON THIS PRODUCT EITHER EXPRESS OR IMPLIED, AND SAMSUNG DISCLAIMS ALL WARRANTIES INCLUDING, BUT NOT LIMITED TO, ANY IMPLIED WARRANTIES OF MERCHANTABILITY, INFRINGEMENT OR FITNESS FOR A PARTICULAR PURPOSE.

---

NO WARRANTY OR GUARANTEE GIVEN BY ANY PERSON, FIRM, OR CORPORATION WITH RESPECT TO THIS PRODUCT SHALL BE BINDING ON SAMSUNG. SAMSUNG SHALL NOT BE LIABLE FOR LOSS OF REVENUE OR PROFITS, FAILURE TO REALIZE SAVINGS OR OTHER BENEFITS, OR ANY OTHER SPECIAL, INCIDENTAL OR CONSEQUENTIAL DAMAGES CAUSED BY THE USE, MISUSE, OR INABILITY TO USE THIS PRODUCT, REGARDLESS OF THE LEGAL THEORY ON WHICH THE CLAIM IS BASED, AND EVEN IF SAMSUNG HAS BEEN ADVISED OF THE POSSIBILITY OF SUCH DAMAGES.

NOR SHALL RECOVERY OF ANY KIND AGAINST SAMSUNG BE GREATER IN AMOUNT THAN THE PURCHASE PRICE OF THE PRODUCT SOLD BY SAMSUNG AND CAUSING THE ALLEGED DAMAGE. WITHOUT LIMITING THE FOREGOING, PURCHASER ASSUMES ALL RISK AND LIABILITY FOR LOSS, DAMAGE, OR INJURY TO PURCHASER AND PURCHASER'S PROPERTY AND TO OTHERS AND THEIR PROPERTY ARISING OUT OF THE USE, MISUSE, OR INABILITY TO USE THIS PRODUCT. THIS LIMITED WARRANTY SHALL NOT EXTEND TO ANYONE OTHER THAN THE ORIGINAL PURCHASER OF THIS PRODUCT, IS NONTRANSFERABLE AND STATES YOUR EXCLUSIVE REMEDY.

Some states do not allow limitations on how long an implied warranty lasts, or the exclusion or limitation of incidental or consequential damages, so the above limitations or exclusions may not apply to you. This warranty gives you specific rights, and you may also have other rights, which vary from state to state.

To obtain warranty service, please contact SAMSUNG at:

**Samsung Electronics America, Inc.**

**85 Challenger Road**

**Ridgefield Park, NJ 07660**

**1-800-SAMSUNG (726-7864)**

**[www.samsung.com/us/support](http://www.samsung.com/us/support)**

Visits by a Service Engineer to explain functions, maintenance, or installation are not covered by warranty.

Please contact the Samsung call center for help with any of these issues.

# Warranty (CANADA)

---

## SAMSUNG WASHER

---

### LIMITED WARRANTY TO ORIGINAL PURCHASER

This SAMSUNG brand product, as supplied and distributed by SAMSUNG ELECTRONICS CANADA, INC. (SAMSUNG) and delivered new, in the original carton to the original consumer purchaser, is warranted by SAMSUNG against manufacturing defects in materials and workmanship for a limited warranty period of:

One (1) year part and labor, Ten (10) years washing DD motor (Part only)

This limited warranty begins on the original date of purchase, and is valid only on products purchased and used in the Canada. To receive warranty service, the purchaser must contact SAMSUNG for problem determination and service procedures. Warranty service can only be performed by a SAMSUNG authorized service center. The original dated bill of sale must be presented upon request as proof of purchase to SAMSUNG or SAMSUNG's authorized service center. SAMSUNG will provide in-home service during the warranty period at no charge, subject to availability within the Canada. In-home service is not available in all areas.

To receive in-home service, product must be unobstructed and accessible to the service agent. If service is not available, SAMSUNG may elect to provide transportation of the product to and from an authorized service center.

---

SAMSUNG will repair, replace, or refund this product at our option and at no charge as stipulated herein, with new or reconditioned parts or products if found to be defective during the limited warranty period specified above. All replaced parts and products become the property of SAMSUNG and must be returned to SAMSUNG. Replacement parts and products assume the remaining original warranty, or ninety (90) days, whichever is longer. This limited warranty covers manufacturing defects in materials and workmanship encountered in normal, noncommercial use of this product and shall not apply to the following: damage that occurs in shipment; delivery and installation; applications and uses for which this product was not intended; altered product or serial numbers; cosmetic damage or exterior finish; accidents, abuse, neglect, fire, water, lightning, or other acts of nature or God; use of products, equipment, systems, utilities, services, parts, supplies, accessories, applications, installations, repairs, external wiring or connectors not supplied or authorized by SAMSUNG that damage this product or result in service problems; incorrect electrical line voltage, fluctuations and surges; customer adjustments and failure to follow operating instructions, maintenance and environmental instructions that are covered and prescribed in the instruction book; product removal and reinstallation; problems caused by pest infestations. This limited warranty does not cover problems resulting from incorrect electric current, voltage or supply, light bulbs, house fuses, house wiring, cost of a service call for instructions, or fixing installation errors. SAMSUNG does not warranty uninterrupted or error-free operation of the product.

EXCEPT AS SET FORTH HEREIN, THERE ARE NO WARRANTIES ON THIS PRODUCT EITHER EXPRESS OR IMPLIED, AND SAMSUNG DISCLAIMS ALL WARRANTIES INCLUDING, BUT NOT LIMITED TO, ANY IMPLIED WARRANTIES OF MERCHANTABILITY, INFRINGEMENT OR FITNESS FOR A PARTICULAR PURPOSE.

# Warranty (CANADA)

---

NO WARRANTY OR GUARANTEE GIVEN BY ANY PERSON, FIRM, OR CORPORATION WITH RESPECT TO THIS PRODUCT SHALL BE BINDING ON SAMSUNG. SAMSUNG SHALL NOT BE LIABLE FOR LOSS OF REVENUE OR PROFITS, FAILURE TO REALIZE SAVINGS OR OTHER BENEFITS, OR ANY OTHER SPECIAL, INCIDENTAL OR CONSEQUENTIAL DAMAGES CAUSED BY THE USE, MISUSE, OR INABILITY TO USE THIS PRODUCT, REGARDLESS OF THE LEGAL THEORY ON WHICH THE CLAIM IS BASED, AND EVEN IF SAMSUNG HAS BEEN ADVISED OF THE POSSIBILITY OF SUCH DAMAGES.

NOR SHALL RECOVERY OF ANY KIND AGAINST SAMSUNG BE GREATER IN AMOUNT THAN THE PURCHASE PRICE OF THE PRODUCT SOLD BY SAMSUNG AND CAUSING THE ALLEGED DAMAGE. WITHOUT LIMITING THE FOREGOING, PURCHASER ASSUMES ALL RISK AND LIABILITY FOR LOSS, DAMAGE, OR INJURY TO PURCHASER AND PURCHASER'S PROPERTY AND TO OTHERS AND THEIR PROPERTY ARISING OUT OF THE USE, MISUSE, OR INABILITY TO USE THIS PRODUCT. THIS LIMITED WARRANTY SHALL NOT EXTEND TO ANYONE OTHER THAN THE ORIGINAL PURCHASER OF THIS PRODUCT, IS NONTRANSFERABLE AND STATES YOUR EXCLUSIVE REMEDY.

Some provinces do not allow limitations on how long an implied warranty lasts, or the exclusion or limitation of incidental or consequential damages, so the above limitations or exclusions may not apply to you.

This warranty gives you specific rights, and you may also have other rights, which vary from province to province.

To obtain warranty service, please contact SAMSUNG at:

**Samsung Electronics Canada Inc.**

**2050 Derry Road West,**

**Mississauga, Ontario L5N 0B9 Canada**

**1-800-SAMSUNG (726-7864)**

**[www.samsung.com/ca/support](http://www.samsung.com/ca/support) (English)**

**[www.samsung.com/ca\\_fr/support](http://www.samsung.com/ca_fr/support) (French)**

**FAX : 1-866-436-4617**

Visits by a Service Engineer to explain functions, maintenance, or installation are not covered by warranty.

Please contact the Samsung call center for help with any of these issues.

# Memo

---



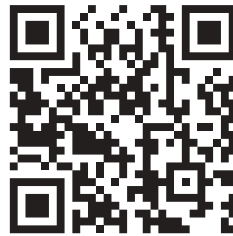

Scan the QR code\* or visit  
[www.samsung.com/spsn](http://www.samsung.com/spsn)  
 to view our helpful  
 How-to Videos and Live Shows

\*Requires reader to be installed on your smartphone

Scan this with your smartphone

**QUESTIONS OR COMMENTS?**

COUNTRY	CALL	OR VISIT US ONLINE AT
U.S.A	1-800-SAMSUNG (726-7864) 1-844-SAM-PAYS (726-7297)	<a href="http://www.samsung.com/us/support">www.samsung.com/us/support</a>
CANADA	1-800-SAMSUNG(726-7864)	<a href="http://www.samsung.com/ca/support">www.samsung.com/ca/support</a> (English) <a href="http://www.samsung.com/ca_fr/support">www.samsung.com/ca_fr/support</a> (French)

The ENERGY STAR symbol applies only to the lower washer.



DC68-03768A-00