

Operating and Installation Instructions Gourmet Drawer



To prevent accidents and machine damage, read these instructions **before** installation or use.

Contents

IMPORTANT SAFETY INSTRUCTIONS	4
Caring for the environment	13
Overview	14
ESW 7010, ESW 7110.....	14
ESW 7570, ESW 7580, ESW 7670, ESW 7680	15
Controls and indicators	16
Included accessories.....	17
Before first use	18
Cleaning the drawer for the first time.....	18
Heating up the drawer for the first time	18
Miele@home.....	19
Operation	22
Using the appliance.....	22
Using MobileStart.....	23
Operating modes.....	23
Duration.....	23
Temperature settings.....	24
Keeping food warm	25
Warming dishes	28
Warming times	28
Capacity	28
ESW 7010, ESW 7110.....	29
ESW 7570, ESW 7580, ESW 7670, ESW 7680	30
Low temperature cooking	31
Other uses	36
Networking with Miele Built-in Appliances	37
Sabbath mode	38
Cleaning and care	39
Frequently Asked Questions	41
Optional accessories	43
Customer Service	44
Contact in the event of a fault.....	44
Data plate	44

Appliance warranty and product registration	44
MieleCare	45
Installation	46
IMPORTANT SAFETY INSTRUCTIONS - INSTALLATION	46
Installation notes	47
Installation dimensions ESW 7010, ESW 7110	48
Combination with an H 2840 or CVA/DGC/H 7x4x	48
Combination with a DGC/H 7x6x	49
Side view	50
Connections and ventilation.....	51
Installation dimensions ESW 7570, ESW 7670	52
Combination with a CVA/DGC/H 7x7x	52
Combination with a DGC/H 7x8x	53
Side view	54
Connections and ventilation.....	55
Installation dimensions ESW 7580, ESW 7680	56
Installation in a tall or base cabinet.....	56
Side view	57
Connections and ventilation.....	58
Installation	59
Electrical connection	60

IMPORTANT SAFETY INSTRUCTIONS

Please note that the Gourmet Drawer is referred to in these operating instructions as the drawer.

This drawer complies with all current local and national safety requirements. Inappropriate use can, however, lead to personal injury and material damage.

Read the operating and installation instructions carefully before using the drawer. They contain important information on safety, installation, use, and maintenance. This prevents both personal injury and damage to the drawer.

In accordance with standard IEC 60335-1, Miele expressly and strongly advises that you read and follow the instructions in the chapter on installing the drawer as well as in the “IMPORTANT SAFETY INSTRUCTIONS”.

Miele cannot be held liable for injury or damage caused by non-compliance with these instructions.

Keep these operating and installation instructions in a safe place and pass them on to any future owner.

IMPORTANT SAFETY INSTRUCTIONS

Appropriate use

- ▶ This drawer is intended for domestic use and use in other similar environments.
- ▶ The drawer is not intended for outdoor use.
- ▶ The warming drawer is intended for domestic use only as described in these instructions. All other use is at the owner's own risk and could be dangerous.
- ▶ Persons who lack physical, sensory or mental abilities, or experience with the appliance should not use it without supervision or instruction by a responsible person.

IMPORTANT SAFETY INSTRUCTIONS

Safety with children

- ▶ As with any appliance, close supervision is necessary when used by children.
- ▶ Do not leave children unattended: Children should not be alone or unsupervised in the area where the appliance is installed. Do not allow them to sit or stand on the appliance.
- ▶ Be sure to supervise any children in the vicinity of the drawer, and do not let them play with it.
- ▶ The drawer gets hot when in use and remains hot for quite a while after being switched off. Keep children away from the drawer until it has cooled down and there is no danger of burning.
- ▶ Danger of suffocation. While playing, children may become entangled in packaging material (such as plastic wrapping) or pull it over their head, presenting the risk of suffocation. Keep packaging material away from children.

IMPORTANT SAFETY INSTRUCTIONS

Technical safety

- ▶ Unauthorized installation, maintenance, and repairs can cause considerable danger for the user. Installation, maintenance, and repairs must only be carried out by a Miele authorized technician.
- ▶ A damaged drawer can be dangerous. Always check for visible signs of damage. Never use a damaged appliance.
- ▶ Reliable and safe operation of the drawer can only be assured if it has been connected to the electrical supply.
- ▶ Be certain the drawer is properly installed and grounded by a qualified technician. To guarantee the electrical safety of this appliance, continuity must exist between the appliance and an effective grounding system. It is imperative that this basic safety requirement be met. If there is any doubt, have the electrical system of the house checked by a qualified electrician.
- ▶ The connection data (voltage and frequency) on the data plate of the drawer must match the domestic electrical supply in order to avoid the risk of damage to the drawer. Compare this data before connecting the appliance. If in any doubt, consult a qualified electrician.
- ▶ Do not connect the drawer to the electrical supply with a power bar or extension cord. These are a fire hazard and do not guarantee the required safety of the appliance.
- ▶ For safety reasons, the drawer may only be used when it has been fully installed.
- ▶ This drawer may not be used in non-stationary locations (e.g. on a ship).
- ▶ Any contact with live connections or tampering with the electrical or mechanical components of the drawer will endanger your safety and may lead to appliance malfunctions. Do not open the casing of the drawer under any circumstances.

IMPORTANT SAFETY INSTRUCTIONS

- ▶ Any repairs not performed by a Miele authorized service technician will void the warranty.
- ▶ Defective components should be replaced by Miele original parts only. Only with these parts can safety of the appliance be assured as intended by the manufacturer.
- ▶ If the plug has been removed or the power cord is not supplied with a plug, the drawer must be connected to the power supply by a suitably qualified electrician.
- ▶ If the power cord is damaged, it must be replaced with a special power cord (see “Electrical connection” under “Installation”).
- ▶ The drawer must be completely disconnected from the power supply during installation, maintenance and repair work. This can be ensured as follows:
 - The circuit breaker has tripped, or
 - The fuse of the electrical installation is completely removed, or
 - The plug (if present) is removed from the outlet. In the process, pull the plug not the cord.
- ▶ If the drawer is installed behind a cabinet door, do not close the door while the drawer is in operation. Heat and moisture can build up behind the closed door and cause damage to the range and to the surrounding cabinets and flooring. Do not close the door until the drawer has completely cooled down.

IMPORTANT SAFETY INSTRUCTIONS

► This device complies with Industry Canada licence-exempt RSS standard(s) and part 15 of the FCC Rules. Operation is subject to the following two conditions:

- (1) This device may not cause harmful interference, and
- (2) this device must accept any interference received, including interference that may cause undesired operation.

The construction of the device assures that the FCC exposure limits are verifiably met using the integrated WiFi module EK037.

Contains:

FCC ID: 2ACUWEK037

IC ID: 5669C-EK037

IMPORTANT SAFETY INSTRUCTIONS

Correct use

- ▶ You could burn yourself on the hot drawer or hot dishware. Protect your hands with heat-resistant pot holders or gloves when handling hot items. Do not let them get wet or damp. Heat transfers through damp and wet material more quickly with the risk of scalding or burning yourself.
- ▶ Risk of fire. Do not store any plastic containers or combustible objects in the drawer. They can melt or catch fire when the appliance is switched on.
- ▶ Due to the high temperatures radiated, objects left near the drawer could catch fire. Do not use the drawer to heat up the room.
- ▶ Never use paper towels or other similar objects in place of the non-slip liner supplied with the appliance.
- ▶ The maximum load capacity of the telescopic drawer rails is 55 lbs (25 kg). If you overload the drawer or lean/stand on it when it is open, you will damage the rails.
- ▶ The underside of the drawer gets hot when it is in use. Be careful not to touch it when the drawer is open.
- ▶ The non-slip liner is heat-resistant up to 395°F (200°C). It is possible for the bottom of cookware to exceed this temperature, especially after they have been used to sear food. Allow cookware to cool down for a minute or two before placing them in the drawer.
- ▶ Cookware made of plastic or aluminum foil will melt at high temperatures. When keeping food warm, use only heat-resistant cookware made of porcelain, glass, etc.
- ▶ Liquids that get inside the warming drawer can cause the appliance to short-circuit. Open and close a loaded drawer carefully to prevent liquids from spilling.

IMPORTANT SAFETY INSTRUCTIONS

- ▶ Keeping Warm mode  is to be used for keeping hot dishes warm, not for heating up cold food. Make sure that any food placed in the drawer is at a high enough temperature.
- ▶ In some foods, bacterial growth may occur if the temperature is too low. Set the appliance to an adequate warming temperature.
- ▶ Loose fitting or hanging garments present a fire hazard. Wear proper apparel while operating the appliance.
- ▶ Smother the fire or flames, or use a dry chemical extinguishing agent or foam fire extinguisher.
- ▶ Before serving, be sure food is at a safe temperature. This is particularly important when preparing food for babies and children.
- ▶ Never warm undiluted alcohol in the warming drawer, this can easily ignite.
- ▶ Exercise caution when warming food with a high sugar content. If heated for too long the sugar may caramelize or ignite.
- ▶ Never add water to food in a hot drawer. The steam created could cause serious burns or scalds.

IMPORTANT SAFETY INSTRUCTIONS

Cleaning and maintenance

- ▶ Danger of electric shock. The steam from a steam cleaner could reach live electrical components and cause a short circuit. Never use a steam cleaner for cleaning.

SAVE THESE INSTRUCTIONS AND REVIEW THEM PERIODICALLY

Disposal of the packing material

The cardboard box and packing materials protect the appliance during shipping. They have been designed to be biodegradable and recyclable.

Ensure that any plastic wrappings, bags, etc. are disposed of safely and kept out of the reach of children. Danger of suffocation!

Disposal of your old appliance

Electrical and electronic appliances contain valuable materials. They also contain certain substances, compounds and components which were essential for the proper functioning and safe use of the equipment. Handling these materials improperly by disposing of them in your household waste can be harmful to your health and the environment. Therefore, please do not dispose of your old appliance with regular household waste and follow local regulations on proper disposal.



Consult with local authorities, dealers or Miele in order to dispose of and recycle electrical and electronic appliances. Miele assumes no responsibility for deleting any personal data left on the appliance being disposed. Please ensure that your old appliance is kept away from children until removal. Observe safety requirements for appliances that may tip over or pose an entrapment hazard.

Overview

ESW 7010, ESW 7110

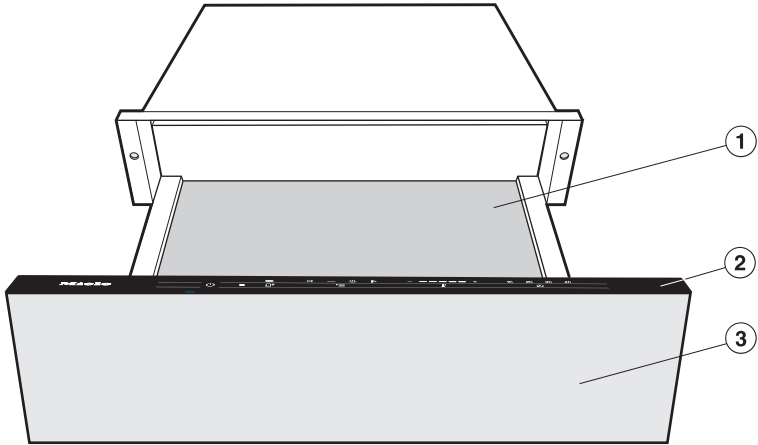

- ① Non-slip liner
- ② Controls and indicators
- ③ Drawer front with Push2open mechanism
The drawer can be opened and closed by lightly pressing the drawer front.

ESW 7570, ESW 7580, ESW 7670, ESW 7680

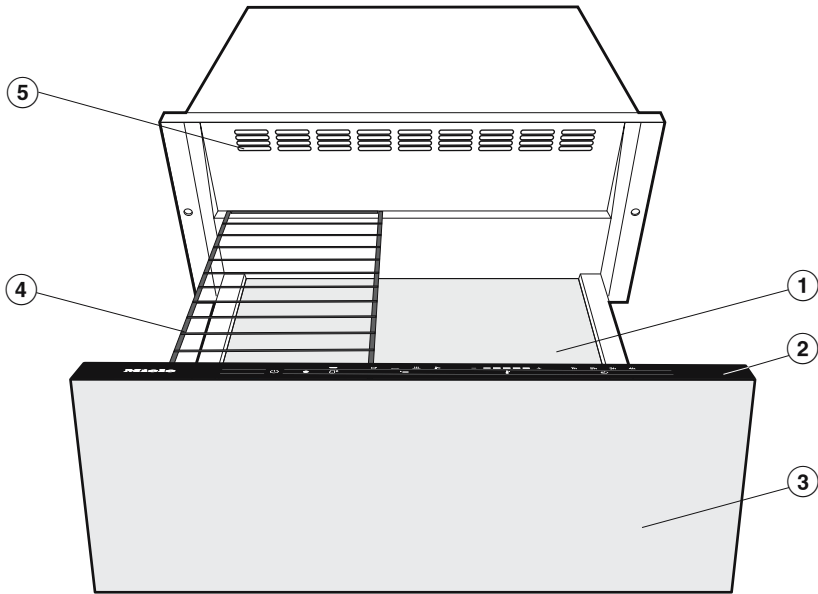

- ① Non-slip liner
- ② Controls and indicators
- ③ Drawer front with Push2open mechanism
The drawer can be opened and closed by lightly pressing the drawer front.
- ④ Wire Rack
- ⑤ Air vents

Overview

Controls and indicators

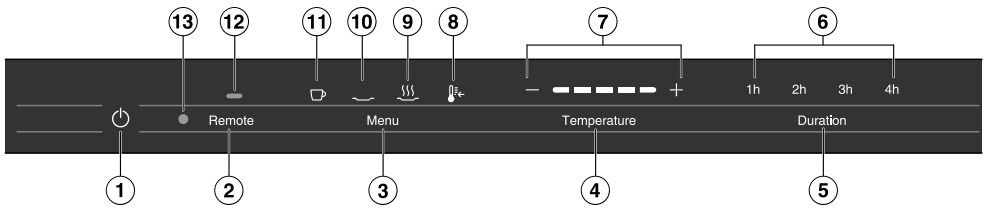

Sensor buttons

- ① ① On/Off sensor control
For switching the drawer on and off
- ② *Remote* sensor button
For controlling the drawer via your mobile device
- ③ *Menu* sensor button
For selecting the operating mode
- ④ *Temperature* sensor button
For setting the temperature
- ⑤ *Duration* sensor button
For setting a specific duration or re-
verting to continuous operation.

Displays/Indicator lights

- ⑥ ⑥ sensor control
For setting a specific duration or re-
verting to continuous operation.
- ⑦ ⑦ Segment bar indicator lights
For displaying the temperature
- ⑧ ⑧ indicator light
Indicates that the
Low temperature cooking operating
mode is set.
- ⑨ ⑨ indicator light
Indicates that the
Keeping food warm operating mode
is set.
- ⑩ ⑩ indicator light
Indicates that the
Warm Dishes/Plates operating mode
is set.
- ⑪ ⑪ indicator light
Indicates that the
Warm Cups/Glasses operating mode
is set.
- ⑫ ⑫ indicator light
Indicates that the drawer can be
controlled via your mobile device.
- ⑬ ⑬ Optical interface
(for Miele Service only)

Included accessories

The accessories supplied with your appliance, as well as a range of optional ones, are available to order from Miele (see “Optional accessories”).

Wire Rack

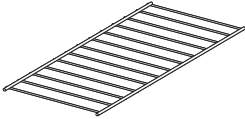

For increasing the loading area (ESW 7570, ESW 7580, ESW 7670, ESW 7680).

Non-slip liner

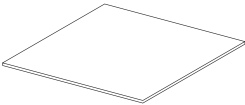

For keeping dishware secure.

Before first use

- Remove any protective foil and stickers.
- Do not remove stickers carrying safety or installation information or the data plate.





This makes it easier to perform servicing and repair work.

Cleaning the drawer for the first time

- Remove the non-slip liner and (if present) the wire rack from the drawer. Clean both with warm water and liquid dish soap, applied with a soft sponge or microfiber cloth.
- Dry the non-slip liner and the wire rack with a soft cloth.
- Wipe the drawer inside and out with a damp cloth to remove any dust or left-over packaging.
- Dry all surfaces with a soft cloth.
- Replace the non-slip liner and the wire rack (if applicable) in the drawer.

Heating up the drawer for the first time

Heat the empty drawer for at least 2 hours.

- Touch the  sensor control to switch the drawer on.
- Touch the *Menu* sensor control repeatedly until the  symbol lights up.
- Touch the  sensor control repeatedly until the segment on the far right-hand side of the temperature display lights up.
- Touch the  sensor control repeatedly until **2 h** lights up.
- Close the drawer.

The drawer is equipped with a contact switch. This ensures that the heating element and fan in the appliance only work when the drawer is closed.

The drawer will switch itself off automatically after 2 hours.

The metal components have a protective coating. For that reason they will give off a slight smell temporarily when the drawer is heated for the first time. The smell and any vapors given off will dissipate after a short time and do not indicate a faulty connection or appliance.

It is important to ensure that the kitchen is well ventilated when heating the drawer for the first time.

Miele@home

Your drawer is equipped with an integrated WiFi module.

To use this feature, you will need:

- a WiFi network
- the Miele app
- a Miele user account You can create a user account via the Miele app.

The Miele app will guide you as you connect your drawer to your home WiFi network.

Once your drawer is connected to your WiFi network, you can use the app, for example, to carry the following activities:

- access information about the operating status of your drawer
- retrieve information on cooking processes that are in progress
- stop cooking programs that are in progress

The drawer requires max. 2 W in networked standby.

Before installing the drawer in its installation site, ensure that the signal of your WiFi network is strong enough.

Availability of the WiFi connection

The WiFi connection shares a frequency range with other appliances (including microwave ovens and remote control toys). This can cause sporadic or even complete connection failures. Therefore, the availability of featured functions cannot be guaranteed.

Miele@home availability

The ability to use the Miele app depends on the availability of the Miele@home service in your country.

The Miele@home service is not available in every country.

For information about availability, please visit www.miele.com.

Miele App

The Miele App is available to download free of charge from the Apple App Store® or from the Google Play Store™.



Before first use

Connecting via the app

The Miele@mobile app can be used to connect to your network.

- Install the Miele@mobile app on your mobile device.

To log in you will need:

1. your WiFi network password
2. your drawer password

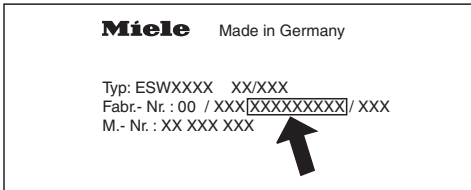

The password for your drawer consists of the last nine digits of the serial number. This can be found on the appliance's data plate.

Data plate

The data plate is located here:

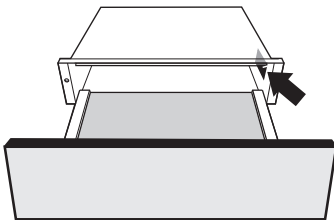

- Start signing the appliance on in the app. Follow the signing in instructions.

If requested to activate the WiFi on the drawer, proceed as follows:

- Turn the drawer off.
- Press and hold the *Duration* sensor control.
- At the same time, touch the *Remote* sensor control.

2 h will light up constantly, **3 h** will flash on and off.

The drawer will be ready for connection in the next 10 minutes.

- Follow the instructions in the app.



When successfully connected, **2 h** and **3 h** will light up constantly.

- Quit the connection mode on the drawer by touching the  sensor control.

The drawer can now be operated via the app.

Connecting via WPS

Your WiFi router must support WPS (WiFi Protected Setup).

- Turn the drawer off.
- Press and hold the  sensor control.
- At the same time, touch the  sensor control.

2 h will light up constantly, **3 h** will flash on and off.

The WPS connection must be started on the drawer at the same time as on the WiFi router.

- Touch the  sensor control on the drawer after a few seconds.

After a short while, **2 h** will light up constantly, and **3 h** and **4 h** will flash on and off.

The drawer will be ready for connection in the next 10 minutes.

- Start the WiFi connection on your WiFi router.

When successfully connected, **2 h** and **3 h** will light up constantly.

- Quit the connection mode on the drawer by touching the  sensor control.



The drawer can now be operated via the app.

If the connection fails, you have probably not activated WPS on your router quickly enough. Repeat the steps above.

Tip: If your WiFi router does not support WPS, please connect via the Miele@mobile app.

Signing out of WiFi (resetting factory defaults)

To set up a new WiFi connection, the existing WiFi connection must be disconnected.

- Turn the drawer off.
- Press and hold the  sensor control.
- At the same time, touch the  sensor control.

With an existing WiFi connection, **2 h** and **3 h** will light up constantly.

The drawer will be ready for disconnection in the next 10 minutes.

- Touch the  sensor control.

2 h will light up constantly, **3 h** will flash on and off.

After a few seconds, **2 h** and **3 h** will start flashing on and off. The connection has now been disconnected.

- Quit the signing off mode on the drawer by touching the  sensor control.

The WiFi connection has now been disconnected. A new connection can now be set up.





Log off the WiFi if you are disposing of your drawer, selling it, or putting a used drawer into operation. This is the only way to ensure that all personal data has been removed and the previous owner will no longer be able to access the drawer.

Operation

Using the appliance

 Malfunction can occur due to dirty and/or covered sensor buttons. The sensor buttons do not react or unintentional switching procedures result, perhaps even the automatic deactivation of the drawer. Keep the sensor buttons and indicators clean. Do not place anything over the sensor buttons or indicators.

 Damage caused by liquids. Liquids that get inside the drawer can cause a short circuit. Open and close a loaded drawer carefully to prevent liquids from spilling.

- Open the drawer.
- Touch the  sensor control to switch the drawer on.
- Touch the  sensor control repeatedly until the required operating mode lights up.
- Touch the  sensor control repeatedly until the segment for the required temperature lights up in the temperature display.
- Touch the  sensor control repeatedly until the required number of hours for the operating time lights up.
- Close the drawer.

Using MobileStart





- Touch the  sensor control to activate MobileStart.

The indicator light above the  sensor control will light up. You can operate your drawer remotely with the Miele@mobile app.

Operation via the sensor buttons has precedence over operation via the app.

Operating modes

The following operating modes are available:

-  Warm Cups/Glasses
-  Warm Dishes/Plates
-  Keeping food warm
-  Low temperature cooking

The last operating mode selected is automatically activated the next time the drawer is switched on, and this is shown in the control field.

The drawer is equipped with a fan which distributes the warmed air within the drawer. The fan runs continuously in all operating modes.

The drawer can be used to keep food warm at the same time as warming dishware. Use the  Keeping food warm operating mode for this.

 Risk of burning due to hot dishware.

Empty dishware will become very hot when heated using the  Keeping food warm operating mode.

Use pot holders when removing the dishware.

Duration

 Fire hazard due to dried-out food.

Long warming times lead to the food drying out, which may cause it to catch fire.

Do not leave the drawer unattended for long periods in continuous operation.

The drawer is set for continuous operating mode (exception: Low temperature cooking). The safety shut-off will turn off the drawer after a maximum of 12 hours of continuous operation.

A limited operating duration can be selected by touching the  sensor control. One touch for 1 hour (1 h), two touches for 2 hours (2 h), etc., up to a maximum of 4 hours.





Continuous operation is restored by touching the sensor control a fifth time.

Operation

Temperature settings

Each operating mode has its own temperature range. The factory default recommended temperatures are printed in bold. The temperature can be altered in 10°F (5°C) increments by touching the  sensor control.

The last temperature selected is automatically activated the next time the drawer is switched on, and this is shown in the control field (exception: Low temperature cooking).

Temperature display	Temperature °F [°C]*			
				
■ □ □ □ □	105 (40)	140 (60)	150 (65)	150 (65)
□ ■ □ □ □	115 (45)	150 (65)	160 (70)	160 (70)
□ □ ■ □ □	120 (50)	160 (70)	165 (75)	165 (75)
□ □ □ ■ □	130 (55)	165 (75)	175 (80)	175 (80)
□ □ □ □ ■	140 (60)	175 (80)	185 (85)	185 (85)

* Approximate temperatures, measured in the center of an empty drawer

Tips

To maintain your food's optimum quality please note the following:

- Place the hot food in pre-heated dishware. Place the dishware in the drawer while it is being pre-heated.
- Do not cover roast or fried food which you want to keep crisp. These types of food need to be kept warm at a higher temperature.
- Cover liquids and food with a high moisture content with a suitable lid or heat-resistant foil. This will prevent moisture escaping and condensing outside the dishware.
- To avoid spilling the food, do not overfill the dishware.
- Freshly cooked food is hotter than food which is being kept warm. Serve food which has been kept warm on pre-heated plates.
- Foods begin to lose their nutrients during the cooking process and continue to do so while being kept warm. The longer food is kept warm, the greater the loss of nutrients.
- We do not recommend food being kept warm for too long, as it will continue to cook.
- Food may cool down if the drawer is opened and closed too often.
- Do not open the drawer too quickly or slam it shut. Liquids could spill over and get into the vents or into the inner parts of the drawer.

Keeping food warm

 Health risk caused by using too low a temperature.

Bacteria may develop in the food if the temperature used for keeping food warm is too low.

Only use the  Keeping food warm operating mode.

This operating mode is for keeping food warm which has just been cooked and is still hot. It is not for reheating food that has gone cold.

- Select the  Keeping food warm operating mode.
- Select the desired duration.

Pre-heat the drawer for approx. 15 minutes to ensure that the interior has reached the required minimum temperature.

- While the appliance is heating up, place the empty dishware in the drawer.
- After 15 minutes, remove the pre-heated dishware from the drawer and fill it with the hot food. Wear pot holders when removing dishware from the drawer.
- Then place the dishware in the drawer and close it carefully to prevent any liquids from spilling.

Settings

Food	Dishware	Cover dishware	Temperature for the  setting	Position	
				Bot- tom	Wire Rack*
Steak rare	Plates	No	<input checked="" type="checkbox"/> <input type="checkbox"/> <input type="checkbox"/> <input type="checkbox"/> <input type="checkbox"/> <input type="checkbox"/>	X	X
Bakes/gratin	Gratin dish	Yes	<input type="checkbox"/> <input type="checkbox"/> <input type="checkbox"/> <input checked="" type="checkbox"/> <input type="checkbox"/> <input type="checkbox"/>	X	
Roasting	Plates	Yes	<input type="checkbox"/> <input type="checkbox"/> <input checked="" type="checkbox"/> <input type="checkbox"/> <input type="checkbox"/> <input type="checkbox"/>	X	
Stew	Pot	Yes	<input type="checkbox"/> <input type="checkbox"/> <input type="checkbox"/> <input checked="" type="checkbox"/> <input type="checkbox"/> <input type="checkbox"/>	X	
Fish strips	Pan	No	<input type="checkbox"/> <input type="checkbox"/> <input type="checkbox"/> <input type="checkbox"/> <input checked="" type="checkbox"/> <input type="checkbox"/>	X	
Meat in a sauce	Pot	Yes	<input type="checkbox"/> <input type="checkbox"/> <input type="checkbox"/> <input checked="" type="checkbox"/> <input type="checkbox"/> <input type="checkbox"/>	X	
Vegetables in sauce	Pot	Yes	<input type="checkbox"/> <input type="checkbox"/> <input type="checkbox"/> <input checked="" type="checkbox"/> <input type="checkbox"/> <input type="checkbox"/>	X	
Goulash	Pot	Yes	<input type="checkbox"/> <input type="checkbox"/> <input type="checkbox"/> <input checked="" type="checkbox"/> <input type="checkbox"/> <input type="checkbox"/>	X	
Mashed potatoes	Pot	Yes	<input type="checkbox"/> <input type="checkbox"/> <input checked="" type="checkbox"/> <input type="checkbox"/> <input type="checkbox"/> <input type="checkbox"/>	X	
Menu	Plates	Yes	<input type="checkbox"/> <input type="checkbox"/> <input type="checkbox"/> <input checked="" type="checkbox"/> <input type="checkbox"/> <input type="checkbox"/>	X	
Baked potatoes/ new potatoes	Plate/pot	Yes	<input type="checkbox"/> <input type="checkbox"/> <input checked="" type="checkbox"/> <input type="checkbox"/> <input type="checkbox"/> <input type="checkbox"/>	X	
Breaded cutlets	Pan	No	<input type="checkbox"/> <input type="checkbox"/> <input type="checkbox"/> <input type="checkbox"/> <input type="checkbox"/> <input checked="" type="checkbox"/>	X	
Pancakes/ potato cakes	Plates	No	<input type="checkbox"/> <input type="checkbox"/> <input type="checkbox"/> <input type="checkbox"/> <input checked="" type="checkbox"/> <input type="checkbox"/>	X	X
Pizza	Plates	No	<input type="checkbox"/> <input type="checkbox"/> <input type="checkbox"/> <input type="checkbox"/> <input type="checkbox"/> <input checked="" type="checkbox"/>	X	
Boiled potatoes	Pot	Yes	<input type="checkbox"/> <input type="checkbox"/> <input type="checkbox"/> <input checked="" type="checkbox"/> <input type="checkbox"/> <input type="checkbox"/>	X	
Sauce	Pot	Yes	<input type="checkbox"/> <input type="checkbox"/> <input type="checkbox"/> <input checked="" type="checkbox"/> <input type="checkbox"/> <input type="checkbox"/>	X	
Strudel	Plates	No	<input type="checkbox"/> <input type="checkbox"/> <input type="checkbox"/> <input checked="" type="checkbox"/> <input type="checkbox"/> <input type="checkbox"/>	X	
Warming bread loaf	–	No	<input checked="" type="checkbox"/> <input type="checkbox"/> <input type="checkbox"/> <input type="checkbox"/> <input type="checkbox"/> <input type="checkbox"/>	X	X
Warming rolls	–	No	<input checked="" type="checkbox"/> <input type="checkbox"/> <input type="checkbox"/> <input type="checkbox"/> <input type="checkbox"/> <input type="checkbox"/>	X	X

* Depending on model

Warming dishes

Tips

- Spread the dishware out across the whole surface if possible. Stacks of plates heat up more slowly than individual pieces of dishware. If you cannot avoid stacking plates, place these at the front of the drawer. Use the wire rack (depending on model).
- Do not place large serving dishes right up against the vents. They will cover the warm air outlets. The dishware will not heat up evenly.
- For cups and glasses, only select the  Warm Cups/Glasses operating mode to ensure that the maximum temperature (140°F/60°C) is not exceeded.
- Heated dishware cools down very quickly. For that reason you should not remove it from the drawer until just before you need it.

Warming times

Various factors will affect the warming times:

- material and thickness of the dishware
- load size
- how the load is arranged
- temperature setting

It is therefore not possible to state precise warming times. For even heating with the  Warm Dishes/Plates operating mode, the following values can be used as a guide:

- 30–35 minutes for 6 place settings to heat up evenly
- 40–45 minutes for 12 place settings to heat up evenly

As you use the appliance, you will get to know which settings suit your own needs best.

Capacity

 Risk of damage due to overloading.

Overloading the drawer will damage the telescopic runners.

The maximum load bearing capacity of the drawer is **55 lb (25 kg)**.

The capacity will depend to a great extent on the size and weight of your dishware.

ESW 7570, ESW 7580, ESW 7670, ESW 7680: the loading area can be increased by using the wire rack supplied with the drawer. The wire rack can be used in a variety of ways. You can also increase the loading area using 2 wire racks positioned on the left and right. An additional wire rack is available to order via the Miele online shop, Miele Customer Service, or from your Miele dealer (see “Optional accessories”).

ESW 7010, ESW 7110

The following loading examples are intended to serve as a guide:

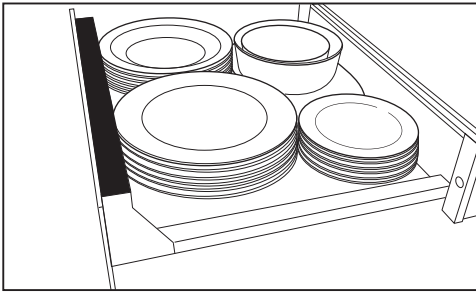

6 place settings

6 dinner plates	Ø 10 1/4" (26 cm)
6 deep soup plates	Ø 9 1/16" (23 cm)
6 dessert plates	Ø 7 1/2" (19 cm)
1 oval platter	12 5/8" (32 cm)
1 serving bowl	Ø 6 5/16" (16 cm)
1 serving bowl	Ø 5 1/8" (13 cm)

Or one of the following arrangements:

12 dinner plates	Ø 10 1/4" (26 cm)
18 deep soup plates	Ø 9 1/16" (23 cm)
16 soup bowls	Ø 4" (10 cm)
6 dinner plates and 6 deep soup plates	Ø 10 1/4" (26 cm) Ø 9 1/16" (23 cm)
6 pizza plates	Ø 14 3/16" (36 cm)
72 espresso cups	Ø 2 5/16" (5.9 cm)
30 cappuccino cups	Ø 3 7/16" (8.8 cm)
30 tea glasses	Ø 2 3/4" (6.7 cm) (3 1/4", 8 cm high)

Warming dishes

ESW 7570, ESW 7580, ESW 7670, ESW 7680

The following loading examples are intended to serve as a guide:

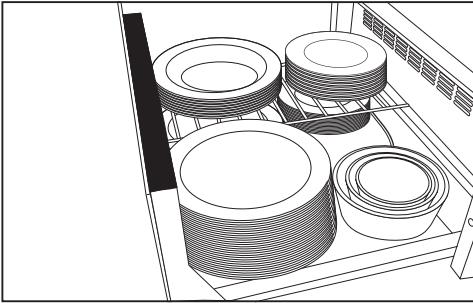

12 place settings

12 dinner plates	Ø 10 1/4" (26 cm)
12 deep soup plates	Ø 9 1/16" (23 cm)
12 dessert plates	Ø 7 1/2" (19 cm)
1 oval platter	12 5/8" (32 cm)
1 serving bowl	Ø 7 1/2" (19 cm)
1 serving bowl	Ø 6 5/16" (16 cm)
1 serving bowl	Ø 5 1/8" (13 cm)

Or one of the following arrangements:

40 dinner plates	Ø 10 1/4" (26 cm)
60 deep soup plates	Ø 9 1/16" (23 cm)
45 soup bowls	Ø 4" (10 cm)
20 dinner plates	Ø 10 1/4" (26 cm)
20 deep soup plates	Ø 9 1/16" (23 cm)
20 pizza plates	Ø 14 3/16" (36 cm)
142 espresso cups	Ø 2 5/16" (5.9 cm)
90 cappuccino cups	Ø 3 7/16" (8.8 cm)
30 tea glasses	Ø 2 3/4" (6.7 cm) (3 1/4", 8 cm high)

With Low temperature cooking, food is cooked at a low temperature over a long period of time. Using this method, food loses less liquid as it is cooked gently and so remains succulent and tender.

If food probes from other Miele Built-in Appliances are used in the drawer, they may affect the built-in appliances.

Only use the Miele Built-in Appliance Food Probe with the built-in appliance that it was supplied with.

For precision, we recommend using a proprietary food probe to monitor the core temperature. The food can then be cooked to perfection.

Core temperature

Food can be cooked to a core temperature of up to 160°F (70°C) in the drawer. Food which needs to be cooked to a core temperature higher than 160°F (70°C) is not suitable for cooking in the drawer.

The core temperature indicates the degree of doneness in the middle of the food.

For meat, the lower the core temperature, the less cooked the meat is in the middle:

- 113-122°F (45–50°C) = rare
- 131-140°F (55–60°C) = medium
- 149°F (65°C) = well done

Cooking time

The cooking time depends on the size of the food, and can be between 1 and 6 hours.

Pre-heat the drawer with the suitable cooking containers for 15 minutes. This ensures that the dishware and the interior of the drawer reach the required temperature.

Example:

Selected time: 1 h

Actual operating time: 1 hour 15 minutes

Notes

- Use meat that has been properly hung.
- The quality of the food is of vital importance for a good result.
- The food must be at room temperature. Take it out of the fridge about 15 minutes before cooking.

Low temperature cooking

Using the Low temperature cooking operating mode

- Select the  Low temperature cooking operating mode.
- Place the heat-resistant dishware in the bottom of the drawer.

The drawer will pre-heat automatically for 15 minutes and then operate at the preset temperature of 185°F (85°C) for a preset time of 4 h.

If you wish to cook on a different setting, please consult the cooking charts on the following pages.

- Select the temperature you want if necessary.
- Select the time you want if necessary.
- After pre-heating, put the food in the dishware.
- If using a food probe:
Push the food probe into the food so that the tip is in the center. Make sure that it does not come into contact with bones or layers of fat as these can cause a false reading.
- When the temperature is approx. 50°F (10°C) (guide value) below the core temperature, remove the food from the drawer.

A smaller temperature difference is recommended for large portions of food.

- Sear the food on all sides over a high heat on the cooktop.

Tips

- Do not cook the food all the way through. Sear the food again after cooking.
- The food can be sliced straight away. It does not need to rest.
- Serve the food on pre-heated plates to stop it cooling too quickly.





Low temperature cooking

Pre-heat the cooking container for 15 minutes. In this time, rest the food at room temperature.

Place the food into the pre-heated cooking container in the compartment.

The cooking durations given in the charts are guidelines only. The food can be cooked further if required.





Beef cooking chart

Type of meat	 [min]	 °F [°C]	 [min]	
Medallions 1 1/4"-1 1/2" (3-4 cm) thick	1 per side	115-125 (45-50)	45-60	<input type="checkbox"/> <input type="checkbox"/> <input checked="" type="checkbox"/> <input type="checkbox"/> <input type="checkbox"/>
	1-2 per side	130-140 (55-60)	65-80	<input type="checkbox"/> <input type="checkbox"/> <input type="checkbox"/> <input checked="" type="checkbox"/> <input type="checkbox"/>
	2 per side	150 (65)	95-110	<input type="checkbox"/> <input type="checkbox"/> <input type="checkbox"/> <input type="checkbox"/> <input checked="" type="checkbox"/>
Sirloin steak approx. 0.4 lb (170 g)	1 per side	115-125 (45-50)	45-60	<input type="checkbox"/> <input type="checkbox"/> <input checked="" type="checkbox"/> <input type="checkbox"/> <input type="checkbox"/>
	2 per side	130-140 (55-60)	65-80	<input type="checkbox"/> <input type="checkbox"/> <input type="checkbox"/> <input checked="" type="checkbox"/> <input type="checkbox"/>
	2 per side	150 (65)	95-110	<input type="checkbox"/> <input type="checkbox"/> <input type="checkbox"/> <input type="checkbox"/> <input checked="" type="checkbox"/>
Rump steak approx. 1/2 lb (200 g)	1 per side	115-125 (45-50)	35-45	<input type="checkbox"/> <input type="checkbox"/> <input checked="" type="checkbox"/> <input type="checkbox"/> <input type="checkbox"/>
	1-2 per side	130-140 (55-60)	45-60	<input type="checkbox"/> <input type="checkbox"/> <input type="checkbox"/> <input checked="" type="checkbox"/> <input type="checkbox"/>
	2 per side	150 (65)	95-110	<input type="checkbox"/> <input type="checkbox"/> <input type="checkbox"/> <input type="checkbox"/> <input checked="" type="checkbox"/>

* 113-122°F (45-50°C) rare, 131-140°F (55-60°C) medium, 149°F (65°C) well done

 Searing time,  Core temperature,  Cooking duration,  Temperature setting

Veal cooking chart





Type of meat	 [min]	 °F [°C]	 [min]	
Medallions 1 1/4"-1 1/2" (3-4 cm) thick	1 per side	115-125 (45-50)	40-55	<input type="checkbox"/> <input type="checkbox"/> <input checked="" type="checkbox"/> <input type="checkbox"/> <input type="checkbox"/>
	2 per side	130-140 (55-60)	60-75	<input type="checkbox"/> <input type="checkbox"/> <input type="checkbox"/> <input checked="" type="checkbox"/> <input type="checkbox"/>
	2 per side	150 (65)	90-105	<input type="checkbox"/> <input type="checkbox"/> <input type="checkbox"/> <input type="checkbox"/> <input checked="" type="checkbox"/>
Steak approx. 0.35 lb (160 g) 3/4" (2 cm) thick	1 per side	115-125 (45-50)	15-30	<input type="checkbox"/> <input type="checkbox"/> <input checked="" type="checkbox"/> <input type="checkbox"/> <input type="checkbox"/>
	2 per side	130-140 (55-60)	30-45	<input type="checkbox"/> <input type="checkbox"/> <input type="checkbox"/> <input checked="" type="checkbox"/> <input type="checkbox"/>
	2 per side	150 (65)	65-80	<input type="checkbox"/> <input type="checkbox"/> <input type="checkbox"/> <input type="checkbox"/> <input checked="" type="checkbox"/>

* 113-122°F (45-50°C) rare, 131-140°F (55-60°C) medium, 149°F (65°C) well done

 Searing time,  Core temperature,  Cooking duration,  Temperature setting

Low temperature cooking





Pork cooking chart

Type of meat	 [min]	 °F [°C]	 [min]	
Tenderloin approx. 19 1/2 lb (550 g)	6–8 total	145 (60)	90–110	<input type="checkbox"/> <input type="checkbox"/> <input type="checkbox"/> <input type="checkbox"/> <input checked="" type="checkbox"/>
Medallions approx. 1 1/2" (4 cm) thick	2 per side	145 (60)	85–100	<input type="checkbox"/> <input type="checkbox"/> <input type="checkbox"/> <input type="checkbox"/> <input checked="" type="checkbox"/>

145°F (65°C) = well done

 Searing time,  Core temperature,  Cooking duration,  Temperature setting





Lamb cooking chart

Type of meat	 [min]	 °F [°C]	 [min]	
Rack of lamb approx. 1/4 lb (170 g)	2–4	135 (60)	45–60	<input type="checkbox"/> <input type="checkbox"/> <input type="checkbox"/> <input checked="" type="checkbox"/> <input type="checkbox"/>
	2–4	150 (65)	85–100	<input type="checkbox"/> <input type="checkbox"/> <input type="checkbox"/> <input type="checkbox"/> <input checked="" type="checkbox"/>
Rack of lamb approx. 3/4 lb (400 g)	2–4	135 (60)	45–60	<input type="checkbox"/> <input type="checkbox"/> <input type="checkbox"/> <input checked="" type="checkbox"/> <input type="checkbox"/>
	2–4	150 (65)	85–100	<input type="checkbox"/> <input type="checkbox"/> <input type="checkbox"/> <input type="checkbox"/> <input checked="" type="checkbox"/>
Saddle of lamb deboned approx. 1 1/4 lb (600 g)	2 per side	135 (60)	45–60	<input type="checkbox"/> <input type="checkbox"/> <input type="checkbox"/> <input checked="" type="checkbox"/> <input type="checkbox"/>
	2 per side	150 (65)	95–110	<input type="checkbox"/> <input type="checkbox"/> <input type="checkbox"/> <input type="checkbox"/> <input checked="" type="checkbox"/>

* 140°F (60°C) medium, 149°F (65°C) well done

 Searing time,  Core temperature,  Cooking duration,  Temperature setting

Game cooking chart



Type of meat	 [min]	 °F [°C]	 [min]	
Venison medallions 1 1/4" (3-4 cm) thick	2 per side	140 (60)	65–80	<input type="checkbox"/> <input type="checkbox"/> <input type="checkbox"/> <input type="checkbox"/> <input checked="" type="checkbox"/>
	2 per side	150 (65)	95–110	<input type="checkbox"/> <input type="checkbox"/> <input type="checkbox"/> <input type="checkbox"/> <input checked="" type="checkbox"/>
Saddle of roe deer approx. 1 1/2 lb (800 g)	2 per side 2 per side	140 (60) 150 (65)	55–70 95–110	<input type="checkbox"/> <input type="checkbox"/> <input type="checkbox"/> <input type="checkbox"/> <input checked="" type="checkbox"/>

* 140°F (60°C) medium, 149°F (65°C) well done

 Searing time,  Core temperature,  Cooking duration,  Temperature setting



Low temperature cooking

Fish cooking chart

Type of fish	 [min]	 °F [°C]	 [min]	
Salmon 0.8 lb (400 g)	2 on the skin side	126 (52)	45–60	<input type="checkbox"/> <input type="checkbox"/> <input type="checkbox"/> <input type="checkbox"/> <input checked="" type="checkbox"/>
Trout (whole) approx. 3/4 lb (350 g)	2 per side	126 (52)	15–30	<input type="checkbox"/> <input type="checkbox"/> <input type="checkbox"/> <input type="checkbox"/> <input checked="" type="checkbox"/>
Cod/skrei 0.4 lb (200 g)	No searing	126 (52)	75–90	<input type="checkbox"/> <input type="checkbox"/> <input type="checkbox"/> <input type="checkbox"/> <input checked="" type="checkbox"/>
Sea bream (whole) approx. 1-1.1 lb (480–500 g)	2 per side	126 (52)	25–40	<input type="checkbox"/> <input type="checkbox"/> <input type="checkbox"/> <input type="checkbox"/> <input checked="" type="checkbox"/>
Branzino (whole) approx. 1-1.1 lb (480–500 g)	2 per side	126 (52)	20–35	<input type="checkbox"/> <input type="checkbox"/> <input type="checkbox"/> <input type="checkbox"/> <input checked="" type="checkbox"/>

 Searing time,  Core temperature,  Cooking duration,  Temperature setting

Other uses

Food	Cookware	Cover dishes			 [h:min]
Defrosting berries	Bowl/plate	No	■ □ □ □ □		0:50
Dissolving gelatin	Bowl	No	□ □ □ □ ■		0:15
Proofing	Bowl	Yes, with plate		■ □ □ □ □	0:30
Preparing yogurt	Yogurt jars with lids	-		□ ■ □ □ □	5:00
Soaking rice pudding	Pot	Yes, with lid	□ □ □ □ ■		0:40
Melting Chocolate	Bowl	No	□ □ □ □ ■		0:20
Defrosting vegetables	Bowl	No	□ □ ■ □ □		1:00

 Temperature setting /  Temperature setting /  Duration

Networking with Miele Built-in Appliances

Networking enables the drawer to operate automatically depending on the operational state of another Miele Built-in Appliance.

Example:

The drawer pre-heats dishware at the right time before or after using the networked built-in appliance.

Prerequisites

The following conditions must be met for networking the drawer with other built-in appliances:

- The drawer is connected to the household WiFi network via Miele@home.
- The other built-in appliance is connected to the household WiFi network via Miele@home.

Carrying out the networking

Networking is carried out via the Miele@mobile app as normal.

See “Before using for the first time – Setting up Miele@home” as well as the Miele@mobile app for detailed information about this function.

Operation via the sensor buttons has precedence over operation via the app.

Sabbath mode

To comply with religious requirements, the drawer can be programmed for the duration of the Sabbath. This mode will be switched off automatically after about 24 or 72 hours, depending on the setting, and normal operation will resume. When this function is activated, the duration setting is deactivated and the sensor controls must be touched for longer than usual.

Activating Sabbath mode

Duration of 24 hours

- If necessary, switch the drawer off.
- Press and hold the  sensor control.
- At the same time, touch the ① sensor control.

2 h and **4 h** will light up.

- Set the required operating mode and temperature.

Duration of 72 hours

- If necessary, switch the drawer off.
- Press and hold the  sensor control.
- At the same time, touch the ① sensor control.

2 h and **4 h** will light up.

- Touch the  sensor control.

1 h, **2 h**, **3 h**, and **4 h** will light up.

- Set the required operating mode and temperature.

Deactivating Sabbath mode

You can deactivate the Sabbath mode before the time has expired.

- Press and hold the ① sensor control.

All displays switch off.

The drawer is in normal mode again.

 Risk of damage due to moisture ingress.

The steam from a steam cleaner could reach live electrical components and cause a short circuit.

Do not use a steam cleaner to clean the drawer.

All surfaces could be discolored or damaged if unsuitable cleaning agents are used. All surfaces are susceptible to scratching. Scratches on glass can lead to breakage in some circumstances.

Remove any residual cleaning agent immediately.

Do not clean with any abrasive or sharp pointed objects.

 Danger of burning from hot interior.

The interior of the drawer will be hot after use.

Allow the drawer to cool down to a safe temperature before cleaning.

- The drawer and accessories should be cleaned and dried after each use.

Unsuitable cleaning agents

To avoid damaging the surfaces of your appliance, do not use:

- cleaning agents containing soda, ammonia, acids, or chlorides
- cleaning agents containing descaling agents
- abrasive cleaning agents, e.g., powder cleaners and cream cleaners
- solvent-based cleaning agents
- stainless steel cleaners
- cleaning agents for ceramic-glass cooktops
- dishwasher cleaning agents
- oven cleaners or sprays
- glass cleaners
- hard, abrasive sponges and brushes, e.g., pot scourers
- sharp metal scrapers

Cleaning and care

Cleaning the drawer front and interior

 Malfunction can occur due to dirty and/or covered sensor buttons. The sensor buttons do not react or unintentional switching procedures result, perhaps even the automatic deactivation of the drawer. Keep the sensor buttons and indicators clean.

Do not place anything over the sensor buttons or indicators.

- It is best to remove normal soiling immediately using a clean sponge and a solution of warm water and liquid dish soap or with a clean, damp microfiber cloth.
- Wipe with clean water afterwards.
- After cleaning, wipe the surfaces dry using a soft cloth.

Cleaning the non-slip liner

 Damage due to incorrect cleaning.

Washing the non-slip liner in a dishwasher or washing machine will damage it.

The non-slip liner should only be cleaned by hand.

 Damage caused by incorrect drying.

Drying the non-slip liner in an oven will damage it.



Never place the non-slip liner in the oven to dry.

- Remove the non-slip liner from the drawer.
- Clean the non-slip liner with warm water and a small amount of liquid dish soap.
- Then dry the non-slip liner with a cloth.
- Replace the non-slip liner in the drawer only when it is completely dry.



Frequently Asked Questions

With the help of the following guide minor faults in the performance of the machine, some of which may result from incorrect operation, can be remedied without contacting the Service Department.

This guide may help you to find the reason for the fault, and how to correct it.

Problem	Possible cause and solution
The drawer does not heat up.	The electrical plug is not properly inserted. ■ Insert the electrical plug.
	The breaker has tripped. ■ Reset the breaker (see data plate for the correct fuse rating). If, after turning the breaker or GFCI back on, the drawer will still not turn on, contact a qualified electrician or Miele Customer Service.
Noise occurs during operation	The noise is caused by the fan, which distributes the heat evenly throughout the drawer. This is not a fault.
The food is not hot enough.	The “Keep Warm”  mode is not set. ■ Set the correct operating mode.
	The temperature setting is too low. ■ Select a higher temperature.
	The air vents are covered. ■ Make sure that air can circulate freely.
The food is too hot.	The “Keep Warm”  mode is not set. ■ Set the correct operating mode.
	The temperature setting is too high. ■ Select a lower temperature.
The dishware is not hot enough.	The  Warm Dishes/Plates operating mode was not selected. ■ Set the correct operating mode.
	The temperature setting is too low. ■ Select a higher temperature.
	The air vents are covered. ■ Make sure that air can circulate freely.
	The dishware has not been warmed long enough. ■ The heating time for dishware is affected by a number of factors (see “Heating dishware”).

Frequently Asked Questions

Problem	Possible cause and solution
The dishware is too hot.	The  Warm Dishes/Plates or  Warm Cups/Glasses operating mode was not selected. ■ Set the correct operating mode.
	The temperature setting is too high. ■ Select a lower temperature.
Abrasion marks on the top edge of the front panel.	Installing or removing an appliance above the drawer has caused abrasion marks. ■ Carefully remove the abrasion marks by rubbing the top edge with the abrasive side of a standard scouring pad.

Optional accessories

Miele offers a range of useful accessories, as well as cleaning and conditioning products for your appliance.

These products can be easily ordered from the Miele webshop.

These products can also be ordered from Miele Technical Service (see the end of these operating instructions) or your Miele dealer.

Wire Rack

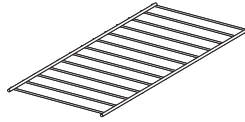

For increasing the loading area (ESW 7570, ESW 7580, ESW 7670, ESW 7680).

Non-slip liner

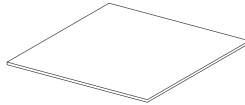

For keeping dishware secure.

Cover strip

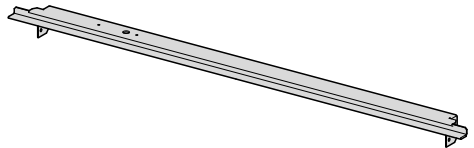

Covers the housing area between the drawer and the combination appliance above it.

Microfiber cloth

Removes finger marks and light soiling.

Customer Service

Contact in the event of a fault

In the event of a fault which you cannot remedy yourself, please contact your Miele dealer or Miele Customer Service.

You can book a Miele Service Call online at www.miele.com/service.

Contact information for Miele Customer Service can be found at the end of this document.

Please quote the model identifier and serial number of your appliance (SN) when contacting Miele Customer Service. Both pieces of information can be found on the data plate.

Data plate

The data plate is located here:

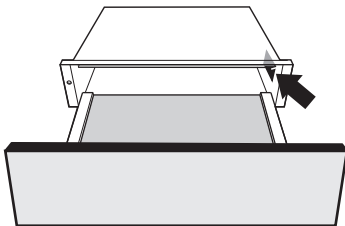

Appliance warranty and product registration

You can register your product and/or view the manufacturer's warranty terms and conditions for Miele appliances and vacuum cleaners at www.mieleusa.com.

This service is available in USA only.

MieleCare, our Extended Service Contract program, gives you the assurance of knowing that your appliance investment is covered by 5 years of worry free ownership.

MieleCare is the only Extended Service Contract in the industry that guarantees repairs by a Miele Authorized Service Provider using genuine Miele parts. Only genuine Miele parts installed by factory trained professionals can guarantee the safety, reliability, and longevity of your Miele appliance.

Please note that unless expressly approved in writing by Miele's Service department, Extended Service Contracts offered by other providers for Miele products will not be recognized by Miele. Our goal is to prevent unauthorized (and untrained) service personnel from working on your Miele products, possibly doing further damage to them, you and/or your home.

To learn more about **MieleCare** Extended Service Contracts, please contact your appliance dealer or visit us online at:

www.mieleusa.com

Installation

IMPORTANT SAFETY INSTRUCTIONS - INSTALLATION



Risk of damage caused by incorrect installation.

Incorrect installation can cause damage to the drawer and/or the combination appliance.

The appliance must only be installed by a qualified person.

- ▶ The electrical outlet must be easily accessible after the installation of the drawer.
- ▶ The drawer may only be built in combination with those appliances specified by Miele as being suitable. Miele cannot guarantee trouble-free operation if the appliance is operated in combination with appliances other than those quoted by Miele as being suitable.
- ▶ The base on which the drawer and the combination appliance are fitted must be fixed in place and must support the weight of both appliances.
- ▶ When installing the combination appliance, it is essential to follow the instructions given in the operating and installation instructions supplied with it.
- ▶ When installing the drawer, the following should be noted:
 - The contents of the dishware must be visible. This is to avoid scalding from hot food spilling over.
 - There must be enough space for the drawer to be pulled out fully.

Installation notes

The drawer is available in 3 models, which differ in height. The building-in dimensions for the drawer must be added to the building-in dimensions for the combination appliance to establish the niche size required.

Combination options

	ESW 7010	ESW 7110	ESW 7570	ESW 7670
CVA 7x4x	✓	✓	-	-
CVA 7x7x	-	-	✓	✓
DGC 7x4x	✓	✓	-	-
DGC 7x6x	✓	✓	-	-
DGC 7x7x	-	-	✓	✓
DGC 7x8x	-	-	✓	✓
H 2840	✓	✓	-	-
H 7x4x	✓	✓	-	-
H 7x6x	✓	✓	-	-
H 7x7x	-	-	✓	✓
H 7x8x	-	-	✓	✓

✓ Can be combined

- Cannot be combined

The combination appliance is placed on top of the drawer without the need for an interim shelf.

ESW 7580, ESW 7680: The drawer cannot be combined with another appliance in a niche.

Install a protective base with a thickness of at least 5/8" (16 mm) between the drawer and another appliance.

Note to the installer:

Please leave these instructions with the consumer of the appliance for the local building inspectors use.

SAVE THESE INSTRUCTIONS.

Installation

Installation dimensions ESW 7010, ESW 7110

Combination with an H 2840 or CVA/DGC/H 7x4x

Miele Drawers can be installed flush or proud. Discuss your requirements with your architect, kitchen designer, and installer.

More installation drawings are available on the Miele website.

The housing unit must not have a back panel installed behind the built-in niche.

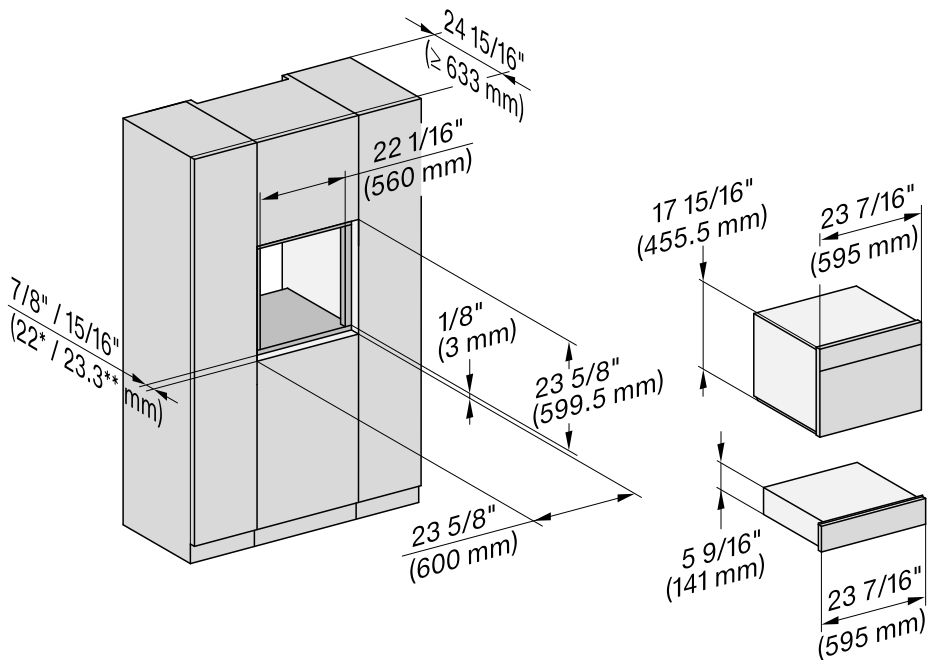

* Drawer with glass front (ESW 7010)

** Drawer with metal front (ESW 7110)

Combination with a DGC/H 7x6x

Miele Drawers can be installed flush or proud. Discuss your requirements with your architect, kitchen designer, and installer.

More installation drawings are available on the Miele website.

The housing unit must not have a back panel installed behind the built-in niche.

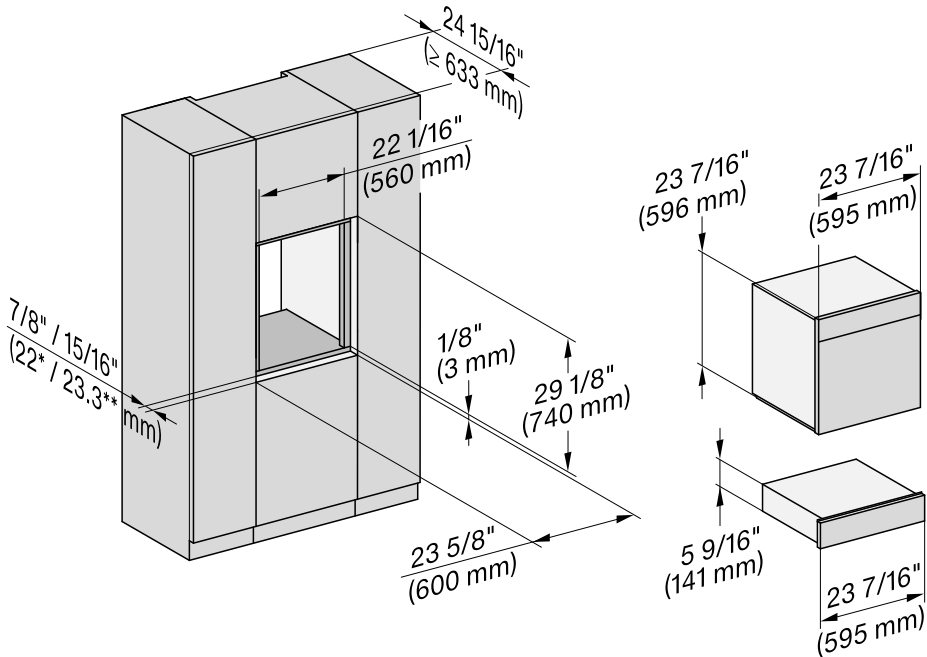

* Drawer with glass front (ESW 7010)

** Drawer with metal front (ESW 7110)

Installation

Side view

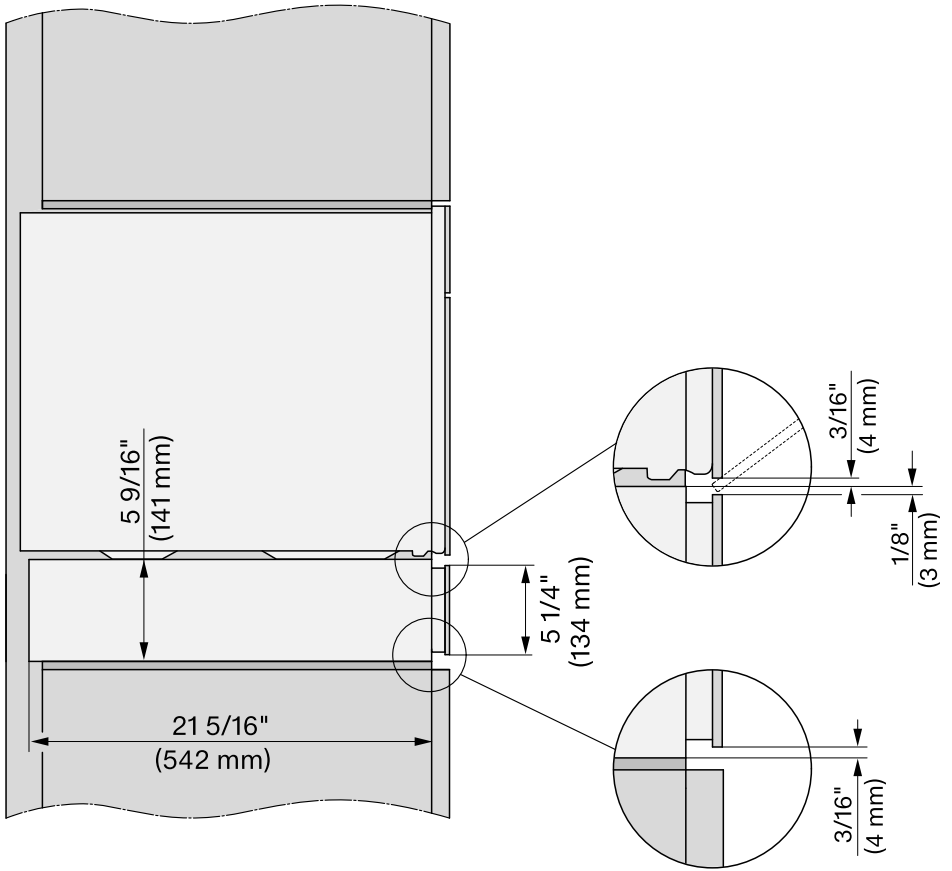

Connections and ventilation

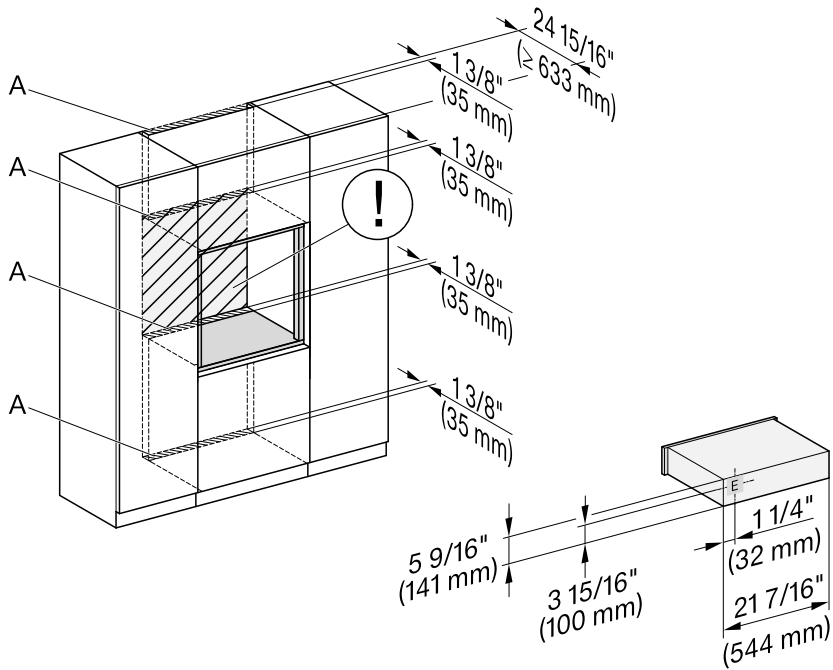

A Cutout (min. $2 \frac{51}{64} \text{ in}^2 / 1,800 \text{ mm}^2$) for power cord, water hoses, and ventilation

! No electrical connection in this area. The socket for the electrical connection must be accessible, e.g., in an adjacent kitchen cabinet.

E Electrical connection

Installation

Installation dimensions ESW 7570, ESW 7670

Combination with a CVA/DGC/H 7x7x

Miele Drawers can be installed flush or proud. Discuss your requirements with your architect, kitchen designer, and installer.

More installation drawings are available on the Miele website.

The housing unit must not have a back panel installed behind the built-in niche.

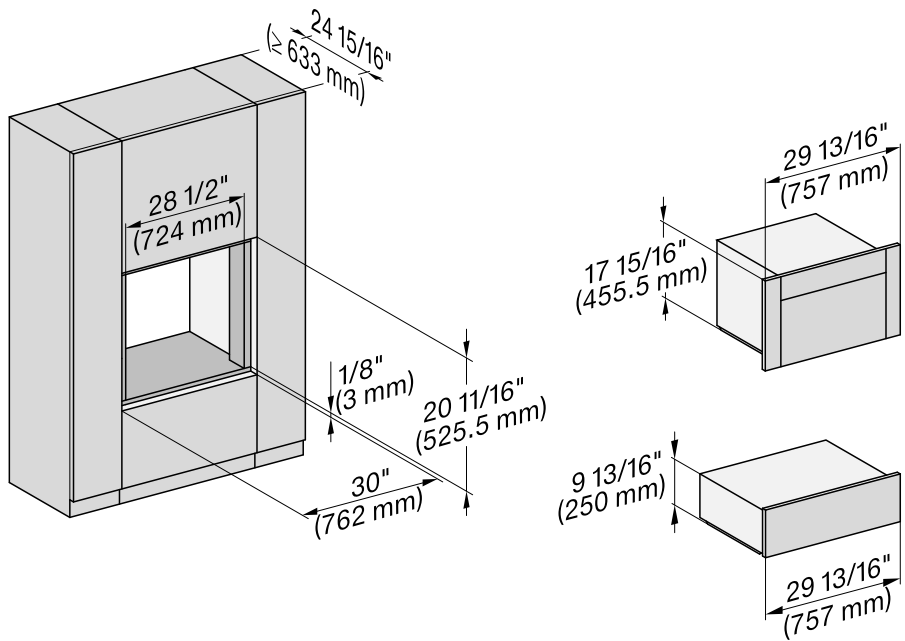

* Drawer with glass front (ESW 76x0)

** Drawer with metal front (ESW 75x0)

Combination with a DGC/H 7x8x

Miele Drawers can be installed flush or proud. Discuss your requirements with your architect, kitchen designer, and installer.

More installation drawings are available on the Miele website.

The housing unit must not have a back panel installed behind the built-in niche.

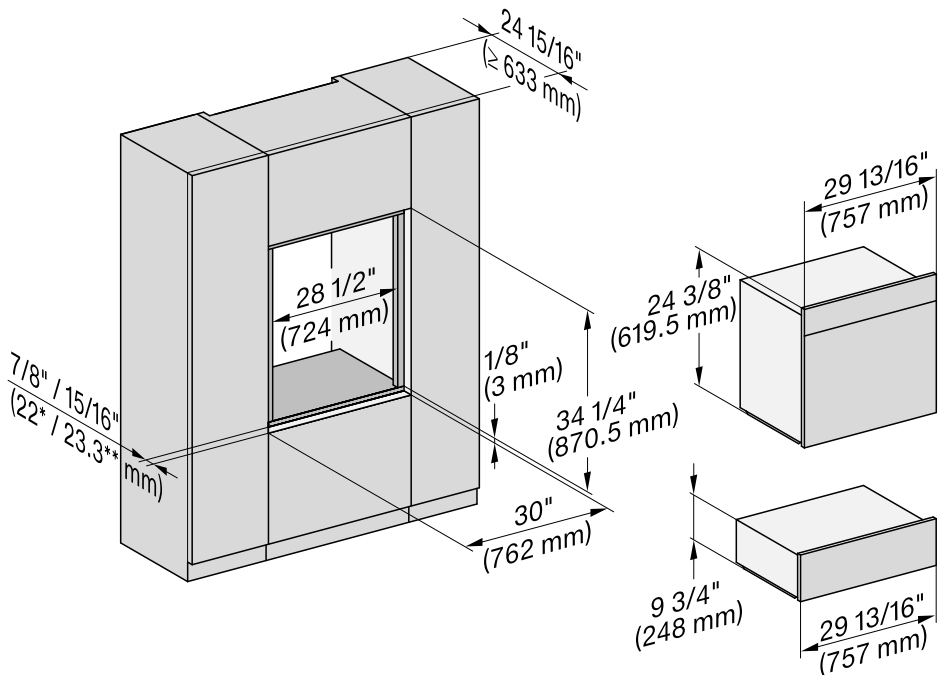

* Drawer with glass front (ESW 76x0)

** Drawer with metal front (ESW 75x0)

Installation

Side view

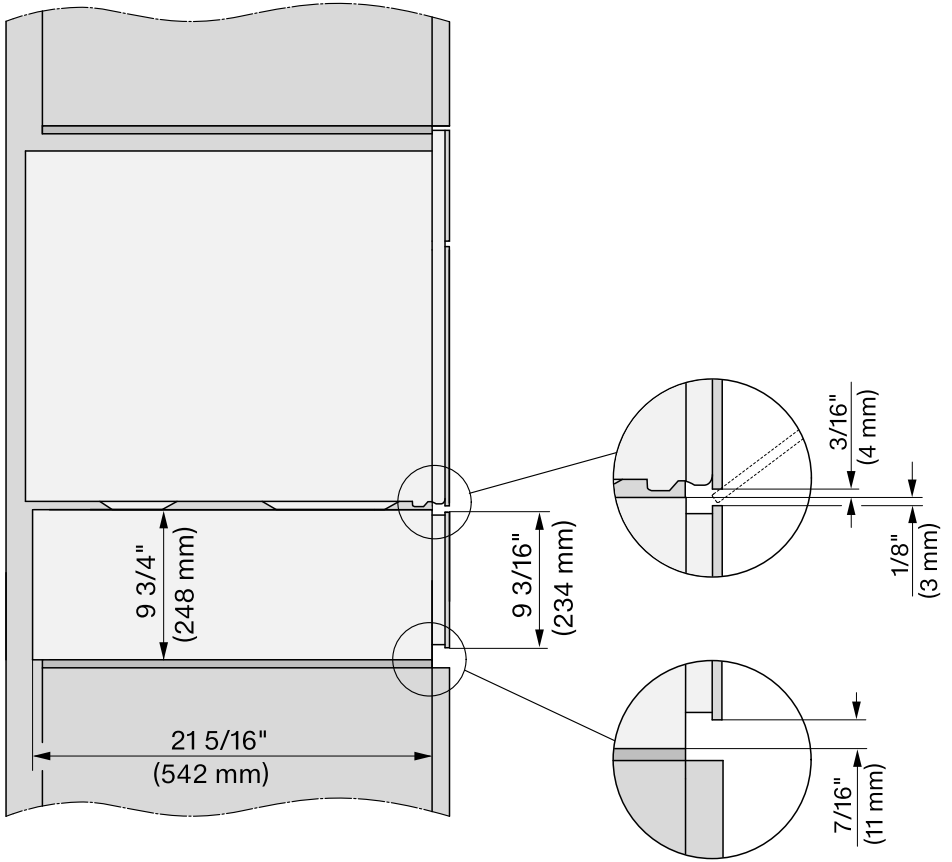

Connections and ventilation

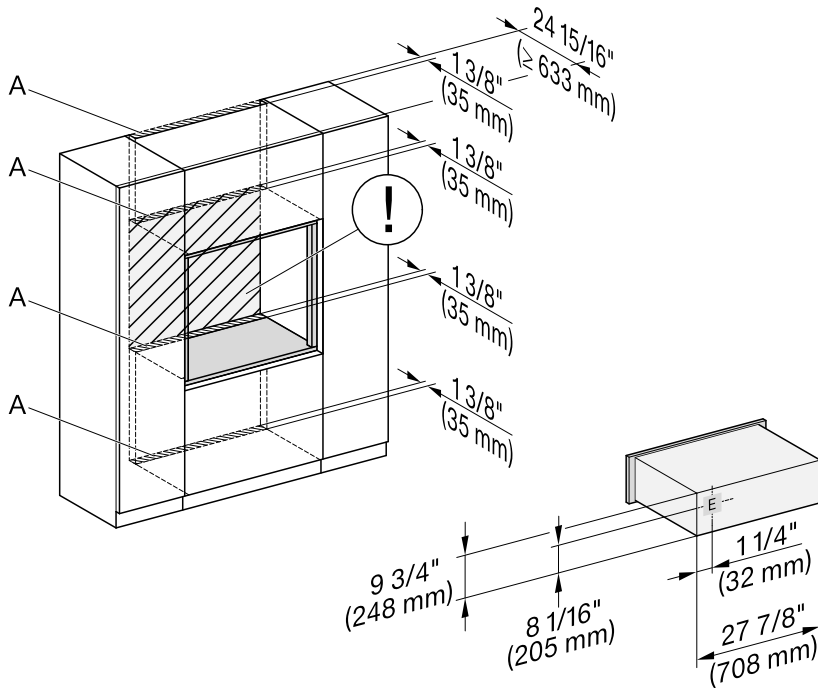

A Cutout (min. $2 \frac{51}{64} \text{ in}^2 / 1,800 \text{ mm}^2$) for power cord, water hoses, and ventilation

! No electrical connection in this area. The socket for the electrical connection must be accessible, e.g., in an adjacent kitchen cabinet.

E Electrical connection

Installation

Installation dimensions ESW 7580, ESW 7680

Installation in a tall or base cabinet

Miele Drawers can be installed flush or proud. Discuss your requirements with your architect, kitchen designer, and installer.

More installation drawings are available on the Miele website.

The housing unit must not have a back panel installed behind the built-in niche.

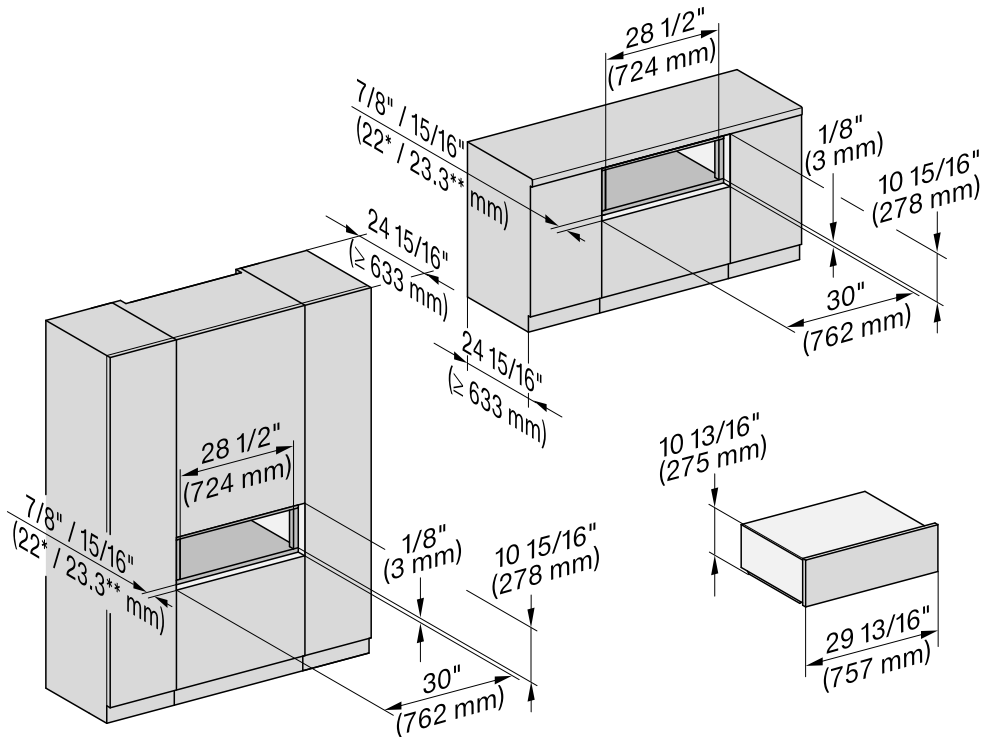

* Drawer with glass front (ESW 76x0)

** Drawer with metal front (ESW 75x0)

Side view

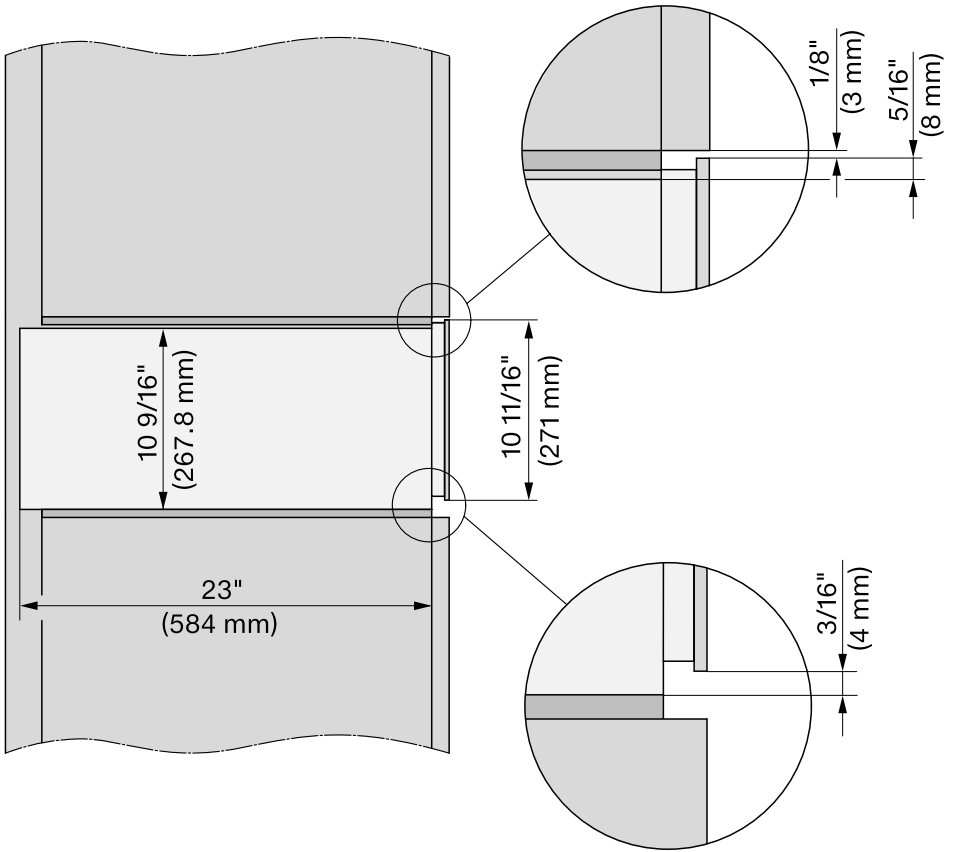

Installation

Connections and ventilation

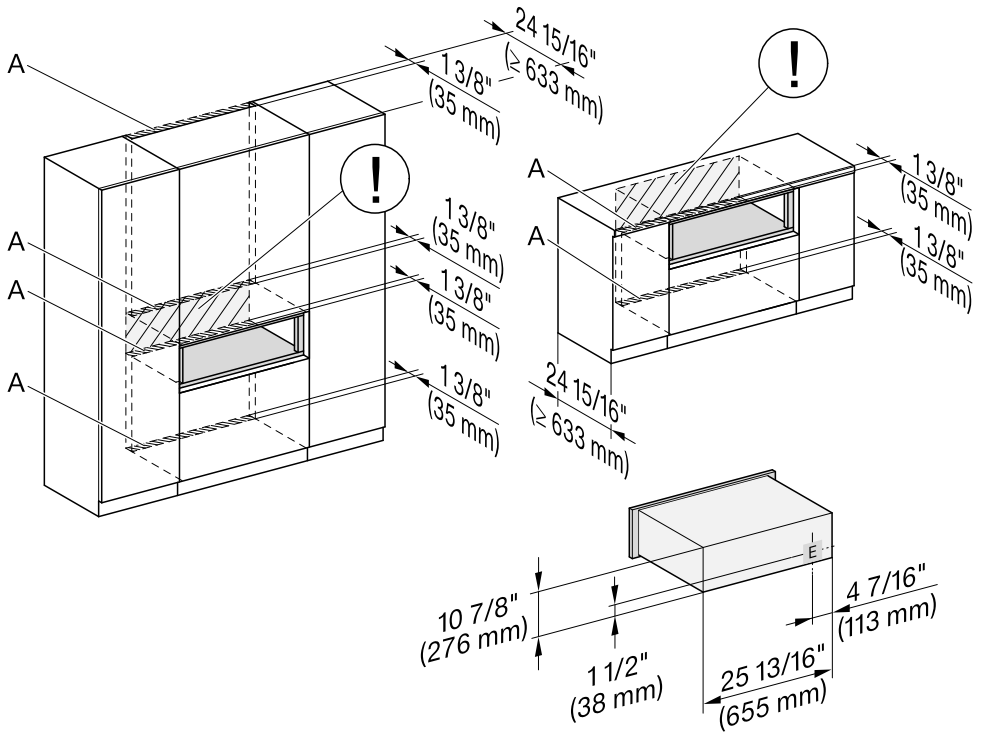

A Cutout (min. $2 \frac{51}{64} \text{ in}^2 / 1,800 \text{ mm}^2$) for power cord, water hoses, and ventilation

! No electrical connection in this area. The socket for the electrical connection must be accessible, e.g., in an adjacent kitchen cabinet.

E Electrical connection

Installation

Check that the base on which the drawer will sit is clean and level (use a level). This is important for the appliance to function correctly.

- Push the drawer into the housing unit until the drawer front is flush with the housing unit and make sure that it is correctly aligned in the unit.

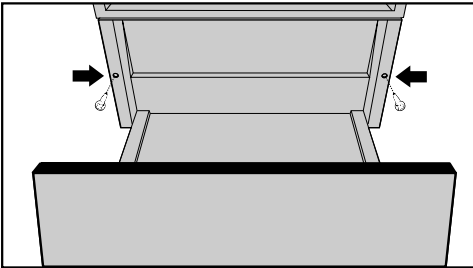

- Open the drawer and use the 2 screws supplied to secure it to the side walls of the cabinet.
- When installing the combination appliance, protect the top edge of the front panel from abrasive marks.
- Install the combination appliance in accordance with the operating and installation instructions supplied with it.

Installation

Electrical connection

ATTENTION:

Before installation or servicing, disconnect the power supply by either removing the fuse, manually “tripping” the circuit breaker or unplugging the appliance. Pull the plug not the cord.

Repairs and service by unqualified persons could be dangerous and the manufacturer will not be held responsible.

Installation work and repairs should only be performed by a qualified technician in accordance with all applicable codes and standards. Installation, repair, and maintenance work should only be performed by a Miele-authorized service technician.

The voltage and frequency listed on the rating label must correspond with the household electrical supply to prevent appliance damage.

Check these data before connection. Consult an electrician if in doubt.

When another appliance is installed in combination with the drawer to the same circuit, operating both appliances at the same time may cause an overload.

If in doubt consult a qualified electrician.

Installer:

- Please leave these instructions with the customer.

Connection

- Make sure that the connection data on the data plate matches that of your electricity supply.

Connection data

The drawer is ready for connection and equipped with a 6' 6" (2.000 mm) power cord with an electrical plug.

120 V/15 A/60 Hz

Make sure that the connecting socket is accessible after the installation of the drawer.

**Please have the model and serial number
of your appliance available when
contacting Customer Service.**

U.S.A.

Miele, Inc.

National Headquarters

9 Independence Way
Princeton, NJ 08540

Customer Service & Support

Phone: 888-99-MIELE(64353)
info@mieleusa.com
www.mieleusa.com

International Headquarters

Miele & Cie. KG
Carl-Miele-Straße 29
33332 Gütersloh
Germany

Canada

**Importer
Miele Limited**

Headquarters and Miele Centre

161 Four Valley Drive
Vaughan, ON L4K 4V8
www.miele.ca

Customer Care Centre

Phone: 800-565-6435
905-532-2272
customercare@miele.ca

ESW 7010, ESW 7110, ESW 7570, ESW 7580, ESW 7670,
ESW 7680