

Operating and Installation Instructions Combi-Steam Ovens



To prevent accidents and machine damage, read these instructions **before** installation or use.

Contents

IMPORTANT SAFETY INSTRUCTIONS	7
Overview	20
Steam oven	20
DGC 7440	20
DGC 7370, DGC 7470	21
Data plate	23
Included accessories	23
Control panel	24
On/Off button	25
Display	25
Sensor buttons	25
Symbols	27
Using the appliance	28
Selecting a menu option	28
Changing a setting in a list	28
Changing the setting with a segment bar	28
Selecting an operating mode or function	29
Entering numbers	29
Entering letters	29
Activating MobileStart	30
Description of functions	31
Control panel	31
Water container	31
Condensate container	31
Temperature	31
Moisture	31
Cooking duration	32
Noises	32
Heating-up phase	32
Cooking phase	32
Steam reduction	33
Oven interior lighting	33
Before first use	34
Miele@home	34
Basic settings	35
Cleaning for the first time	36
Setting the correct boiling point for water	37
Heating up the steam oven	38

Settings	39
Settings overview	39
Opening the “Settings” menu.....	41
Language 	41
Time.....	41
Date	42
Lighting.....	42
Display.....	42
Volume.....	43
Units	43
Keeping warm	44
Steam reduction	44
Recommended temperatures.....	45
Booster	45
Water hardness	46
Automatic rinsing	47
Safety	47
Miele@home	48
Remote control.....	49
Activating MobileStart	49
RemoteUpdate	49
Software version.....	50
Demo Mode.....	50
Factory default.....	51
Timer	52
Main and submenus	53
Energy-saving tips	56
Operation	57
Changing values and settings for a cooking program.....	58
Changing the temperature.....	59
Changing Moisture	59
Setting additional durations	59
Changing set cooking durations	60
Deleting the set cooking durations.....	60
Canceling a cooking program	61
Interrupting a cooking program.....	62
Preheating the oven	63
Booster.....	63
Preheat	64
Crisp function	64

Contents

Injecting bursts of steam.....	65
General notes	66
The advantages of cooking with steam	66
Suitable containers.....	66
Shelf level	67
Frozen food.....	67
Temperature	67
Cooking duration	67
Cooking with liquid.....	67
Your own recipes - Steam cooking	67
Universal tray and wire rack	68
Steam cooking	69
Notes on the cooking charts	69
Vegetables.....	70
Fish.....	73
Meat	76
Rice	78
Grains	79
Pasta/noodles	80
Dumplings	81
Legumes.....	82
Eggs	84
Fruit	85
Sausage.....	85
Shellfish	86
Mussels	87
Menu Cooking	88
Sous-vide (vacuum) cooking	90
Additional applications	98
Reheat	98
Defrost.....	100
Miele Mix & Match.....	103
Blanching.....	115
Canning	115
Canning cakes.....	118
Dehydrate	119
Proofing	120
Sanitizing Cookware	120
Sabbath Program	121
Warm-up Cookware	122

Keep warm	122
Heating damp towels	123
Dissolving Gelatine.....	123
Decrystallize honey	124
Melting Chocolate	124
Making Yogurt	125
Rendering Fat.....	126
Sweating Onions	126
Juicing	127
Fruit jam.....	128
Skinning Fruits and Vegetables	129
Preserving Apples	129
Preparing custard royale	129
Automatic programs	130
Categories	130
Using automatic programs	130
Usage notes	130
Favorites	131
Baking	134
Baking tips.....	134
Tips for baking.....	135
Notes on the operating modes.....	135
Roasting	137
Roasting tips	137
Notes on the operating modes.....	137
Broiling	139
Broiling tips.....	139
Tips for broiling.....	139
Notes on the operating modes.....	140
Cleaning and care for the steam oven	141
Important information on cleaning and care	141
Unsuitable cleaning agents	142
Cleaning the steam oven front	142
PerfectClean.....	143
Oven compartment	144
Cleaning the water container and condensate container.....	145
Accessories	146
Cleaning the side racks	147

Contents

Lowering the browning/broiling element	148
Maintenance	149
Soaking	149
Drying	149
Rinsing.....	149
Descaling the steam oven	149
Removing the door.....	151
Installing the door.....	152
Frequently Asked Questions	153
Optional accessories	158
Containers	158
Other.....	158
Cleaning and care products	158
Customer Service	159
Contact in the event of a fault	159
Appliance warranty and product registration	159
Caring for the environment	160
Installation	161
IMPORTANT SAFETY INSTRUCTIONS - INSTALLATION	161
Installation dimensions DGC 7440	162
Installation in a tall cabinet	162
Side view	163
Swivel range for control panel.....	164
Connections and ventilation.....	165
Installation dimensions DGC 7370, DGC 7470	166
Installation in a tall cabinet	166
Side view	167
Swivel range for control panel.....	168
Connections and ventilation.....	169
Installing and removing the steam oven.....	170
Electrical connection	173
Declaration of conformity	174

IMPORTANT SAFETY INSTRUCTIONS

When using the appliance, please comply with the basic safety requirements, including the following instructions:

Read all instructions before installation and use of the steam oven to prevent accidents and damage to the appliance.

The Combi-Steam Oven is referred to in the following instructions as a steam oven.

This appliance complies with all current local and national safety requirements. Inappropriate use can, however, lead to personal injury and material damage.

Please read these operating and installation instructions carefully before using the steam oven for the first time. They contain important information on safety, installation, use, and maintenance. This prevents both personal injury and damage to the steam oven. Miele cannot be held liable for injury or damage caused by non-compliance with these instructions.

Keep these operating and installation instructions in a safe place and pass them on to any future owner.

IMPORTANT SAFETY INSTRUCTIONS

Appropriate use

- ▶ This appliance is intended for residential use only.
- ▶ The steam oven is not suitable for outdoor use.
- ▶ The steam oven is intended only to steam, bake, roast, broil, defrost, and reheat food.
All other types of use are not permitted.
- ▶ Risk of fire. Never use the steam oven to store or dry items which could ignite easily.
- ▶ Persons who lack physical, sensory or mental abilities, or experience with the appliance should not use it without supervision or instruction by a responsible person.
- ▶ This steam oven is supplied with a special bulb to cope with particular conditions (e.g. temperature, moisture, chemical resistance, abrasion resistance and vibration). This special bulb must only be used for the purpose for which it is intended. It is not suitable for room lighting. Replacement of bulbs may only be carried out by a Miele authorized technician.

IMPORTANT SAFETY INSTRUCTIONS

Safety with children

- ▶ Activate the system lock to ensure that children cannot switch on the steam oven inadvertently.
- ▶ Please supervise children in the vicinity of the steam oven and do not let them play with it.
- ▶ Risk of burns due to improper use. Do not allow children to operate the steam oven.
- ▶ Risk of suffocation from packaging material. While playing, children may become entangled in packaging material (such as plastic wrapping) or pull it over their head, presenting the risk of suffocation. Keep packaging material away from children.
- ▶ Danger of injury caused by hot surfaces. Children's skin is far more sensitive to high temperatures than that of adults. External parts of the steam oven such as the door glass, control panel, and the vent become quite hot. Do not let children touch the steam oven when it is in operation.
Keep children well away from the steam oven until it has cooled down and there is no danger of injury.
- ▶ Risk of injury from the open door. The oven door can support a maximum weight of 22 lbs (10 kg). Children could injure themselves on an open door.
Do not let children sit on the door, lean against it, or swing on it.

IMPORTANT SAFETY INSTRUCTIONS

Technical safety

- ▶ This steam oven must be installed and connected in compliance with the installation instructions.
- ▶ Unauthorized installation, maintenance, and repairs can cause considerable danger for the user. Installation, maintenance, and repairs must only be carried out by a Miele authorized technician.
- ▶ Changes or modifications not expressly approved by Miele may void the user's authority to operate the steam oven.
- ▶ Maintenance by the user: Never repair or replace any part of the appliance unless the instructions specifically recommend doing so. Service work should only be performed by a qualified technician.
- ▶ A damaged appliance is dangerous. Check the appliance for any visible damage. Never install or attempt to use a damaged appliance.
- ▶ Reliable and safe operation of this steam oven can only be assured if it has been connected to the power supply.
- ▶ Be certain your appliance is properly installed and grounded by a qualified technician. To guarantee the electrical safety of this appliance, continuity must exist between the appliance and an effective grounding system. It is imperative that this basic safety requirement be met. If there is any doubt, have the electrical system of the house checked by a qualified electrician.
- ▶ Proper installation: Make sure that your appliance has been installed correctly and that it has been grounded by a qualified technician.
- ▶ Before connecting the appliance to the power supply, ensure that the connection data on the data plate (voltage and frequency) match the power supply.
This data must correspond in order to avoid the risk of damage to the appliance. Consult a qualified electrician if in any doubt.

IMPORTANT SAFETY INSTRUCTIONS

- ▶ Do not use an extension cord to connect this appliance to the power supply. Extension cords do not guarantee the required safety of the appliance.
- ▶ Maintain the required minimum installation height of 36" (914 mm).
- ▶ For safety reasons, this appliance may only be used after it has been built in.
- ▶ This steam oven must not be used in a non-stationary location (e.g. on a ship).
- ▶ Risk of injury due to electric shock. Any contact with live connections or tampering with the electrical or mechanical components of the oven will endanger your safety and may lead to the steam oven malfunctioning.
Do not open the steam oven housing under any circumstances.
- ▶ While the appliance is under warranty, repairs should only be performed by a Miele-authorized service technicians. Work by unqualified persons could be dangerous and may void the warranty.
- ▶ Defective components should be replaced by Miele original parts only. Only with these parts can safety of the appliance be assured as intended by the manufacturer.
- ▶ If the electrical plug is removed from the power cord or if the power cord is supplied without an electrical plug, the steam oven must be connected to the electricity supply by a qualified service technician.
- ▶ If the power cord is damaged, it must be replaced with a special power cord (see "Electrical connection" under "Installation").

IMPORTANT SAFETY INSTRUCTIONS

- ▶ During installation, maintenance and repair work, the appliance must be disconnected from the main electricity supply. It is only completely isolated from the electricity supply when:
 - The circuit breakers have been switched off, or
 - The fuses of the electrical installation have been completely removed, or
 - Unplug (if plug present) the machine from the outlet. Pull the plug not the cord.

- ▶ If the steam oven is installed behind a cabinet front (e.g., a door), do not close the cabinet front while the steam oven is in use. Heat and moisture can build up behind the cabinet front when closed. This can result in damage to the steam oven, the housing unit, and the floor. Leave the door panel open until the steam oven has cooled down completely.

IMPORTANT SAFETY INSTRUCTIONS

Correct use

- ▶ Danger of burning. The heater elements may still be hot even if they are not glowing red. The surfaces of the oven compartment can cause burns if they are touched. External parts of the steam oven such as the door glass, control panel, and the vent become quite hot. During operation and after turning the steam oven off, make sure that you do not touch any hot parts and surfaces and do not let any items of clothing or flammable objects come into contact with these. Wait until the steam oven has cooled down.
- ▶ Do not let food sit in the oven for an extended period of time before or after cooking. Doing so can result in food poisoning or sickness.
- ▶ Loose fitting or hanging garments present a fire hazard. Wear proper apparel while operating the appliance.
- ▶ Use only dry, heat-resistant potholders. Moist or damp potholders used on hot surfaces may result in steam burns. Do not let potholders come in contact with oil or grease. Do not substitute dish towels or other bulky items for potholders. Do not let potholders touch hot heating elements.
- ▶ Open the door carefully to allow hot air or steam to escape before placing or removing food.
- ▶ Danger of burning. Push the baking trays and wire racks onto the corresponding level before heating up the steam oven. If you want to remove the baking tray or wire rack while the oven compartment is hot, do not touch the heater elements with the pot holders.
- ▶ To prevent burns, allow the heating elements to cool before cleaning by hand.
- ▶ Smother the fire or flames, or use a dry chemical extinguishing agent or foam fire extinguisher.
- ▶ Do not store any flammable liquids and objects near to the steam oven or cooktop.

IMPORTANT SAFETY INSTRUCTIONS

WARNING

Never use the steam oven to heat or warm up a room. This may result in carbon monoxide poisoning and overheating of the steam oven.

WARNING

Never use the steam oven for storage purposes. This may result in carbon monoxide poisoning and overheating of the steam oven.

WARNING

Never cover slots, holes, or openings in the base of the steam oven or cover the entire wire rack with materials such as aluminum foil. This blocks the air flow in the steam oven and can cause carbon monoxide poisoning. Covers made of aluminum foil can also cause heat to build up, which could lead to a fire.

- ▶ Do not obstruct the flow of combustion and ventilation air.
- ▶ Only use the steam oven to prepare food. Corrosive chemicals and vapors such as those caused by heated adhesives, plastic, or flammable liquids and objects can be harmful to the health. Do not use the steam oven for drying, toasting, or dehumidifying.
- ▶ Do not let metal objects (aluminum foil, pans) come in contact with the heating element.
- ▶ Make certain that the power cords of small appliances do not come in contact with or get caught in the oven door.
- ▶ Risk of injury caused by hot surfaces and steam. The steam oven gets hot during operation. You could burn yourself on the heater elements, oven compartment, side racks, accessories, food, or steam. Use pot holders when placing food in the appliance or removing it and when working in the hot oven compartment.

IMPORTANT SAFETY INSTRUCTIONS

- ▶ Risk of injury caused by hot food.

Food may spill or splash around when placing it into the oven or removing it. The food can cause burns.

When placing cooking containers in the oven or removing them, make sure that the hot food does not spill.

- ▶ Do not heat up food in closed containers e.g. tins or sealed jars in the steam oven, as pressure will build up in the container, causing it to explode.

- ▶ Plastic containers which are not suitable for use in an oven can melt at high temperatures and can even damage the steam oven or catch fire.

Only use plastic containers which are declared by the manufacturer as being suitable for use in a steam oven. Follow the manufacturer's instructions on use. If you want to use plastic containers for steaming food make sure that they are temperature resistant to 212°F (100°C) and steam resistant. Any other plastic containers could melt, become brittle or break when subjected to heat.

- ▶ Risk of injury caused by steam. Pouring a cold liquid onto a hot surface creates steam, which can cause severe scalding. The sudden temperature change can also cause damage to hot surfaces. Never pour cold liquids directly onto hot enameled surfaces.

- ▶ It is important that the temperature in the food being cooked is evenly distributed and sufficiently high. You can ensure this by stirring or turning the food.

- ▶ Food which is left in the oven compartment can dry out and the moisture released can lead to corrosion damage in the steam oven. Do not leave food in the oven compartment and do not use any cooking containers which are susceptible to corrosion.

- ▶ Risk of injury from the open door. You could bang into the open door or trip over it. Do not leave the door open unnecessarily.

IMPORTANT SAFETY INSTRUCTIONS

▶ The door can support a maximum weight of 22 lbs (10 kg). Do not sit, lean or place heavy items on the open oven door. Also be sure nothing can get trapped between the door and the oven cavity. The steam oven could get damaged.

▶ Oil and fat can ignite if overheated. Never leave the steam oven unattended when cooking with oil and fat.

If it does ignite do not put the flames out with water. Switch the steam oven off immediately and then suffocate the flames by keeping the oven door closed.

▶ Due to the high temperatures radiated, objects left near the steam oven when it is in use could catch fire.

Do not use the steam oven to heat up the room.

▶ Broiling food for excessively long cooking durations can cause it to dry out with the risk of catching fire. Do not exceed the recommended cooking durations.

▶ Certain foods dry out quickly and may catch fire due to high broiling temperatures.

Never use broiling modes to finish baking par-cooked rolls or bread, or to dry flowers or herbs. Instead, use the Convection Bake  or Surround operating mode.

▶ To avoid fueling any flames, do not open the steam oven door if there is smoke inside the oven compartment. Interrupt operation by turning the steam oven off and disconnecting it from the electricity supply. Do not open the door until the smoke has dispersed.

▶ Use caution when using alcohol in your recipes. Alcohol evaporates at high temperatures but may, in rare circumstances, combust on the hot heating elements.

IMPORTANT SAFETY INSTRUCTIONS

- ▶ Never line the floor of the oven with aluminum foil or oven liners. Do not place any dishware or any pans, pots, or baking trays directly on the floor of the oven compartment. If you want to use the floor of the oven compartment as an extra surface, place the wire rack on the floor of the oven compartment with the rack surface facing up and the dishware on top. In doing so, ensure that the filter in the floor of the oven is not moved.
- ▶ The oven compartment floor can become damaged by the wire rack being pushed around on it. Do not push the wire rack around on the oven compartment floor.
- ▶ Larger deposits of food can block the drain and pump. Always make sure that the filter in the floor of the oven is inserted.
- ▶ When using a small electrical appliance, e.g., a hand-held blender, near the steam oven, care should be taken that the power cord of the appliance cannot get trapped by the steam oven door. This could damage the insulation on the cord.
- ▶ Do not operate the appliance without the bulb cover. Steam could attack the electrical components and cause a short circuit. Steam could also damage the electrical components.

IMPORTANT SAFETY INSTRUCTIONS

Cleaning and maintenance

- ▶ Only clean parts listed in these operating and installation instructions.
- ▶ Risk of injury due to electric shock. The steam from a steam cleaning appliance could reach live electrical components and cause a short circuit. Never use a steam cleaner for cleaning.
- ▶ Scratches on the door glass can cause the glass to break. Do not use abrasive cleaners, hard sponges, brushes or sharp metal tools to clean the door glass.
- ▶ The side racks can be removed (see “Cleaning the side racks” under “Cleaning and care for the steam oven”). Reinstall the side racks correctly.
- ▶ To avoid corrosion on the stainless steel surfaces, remove any splashes on the interior walls of the oven from food or liquids containing salt.
- ▶ In warm, moist environments, there is a higher probability of pest infestations. Ensure the steam oven and the area surrounding it are always kept clean.
Damage caused by pests is not covered by the warranty.

IMPORTANT SAFETY INSTRUCTIONS

Accessories

- ▶ Use only genuine original Miele parts. If parts or accessories from other manufacturers are used, the warranty may become void.
- ▶ The perforated and solid cooking pans will be damaged by high temperatures! Use them only in modes and programs that work exclusively with steam.
- ▶ This device complies with Industry Canada licence-exempt RSS standard(s) and part 15 of the FCC Rules. Operation is subject to the following two conditions:
 - (1) This device may not cause harmful interference, and
 - (2) this device must accept any interference received, including interference that may cause undesired operation.

The construction of the device assures that the FCC exposure limits are verifiably met using the integrated WiFi module EK037.

Contains:

FCC ID: 2ACUWEK037

IC ID: 5669C-EK037

KEEP THE OPERATING AND INSTALLATION INSTRUCTIONS IN A SAFE PLACE AND REVIEW THEM PERIODICALLY.

Overview

Steam oven

DGC 7440

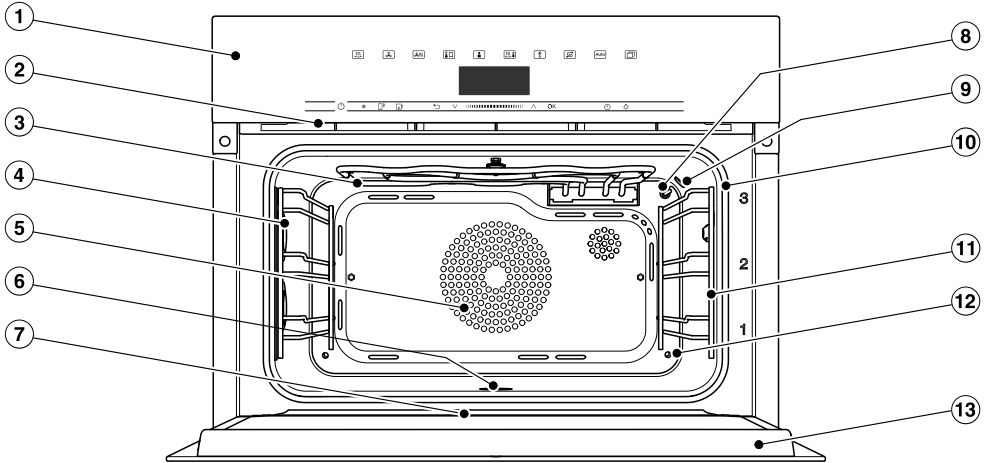

- ① Controls
- ② Vent
- ③ Browning/Broiling element
- ④ Oven interior lighting
- ⑤ Convection fan with heating element
- ⑥ Oven floor with bottom heater element and floor filter underneath it
- ⑦ Drip channel
- ⑧ Temperature sensor
- ⑨ Moisture sensor
- ⑩ Door seal
- ⑪ Side runners with 3 shelf levels
- ⑫ Steam inlet
- ⑬ Door

DGC 7370, DGC 7470

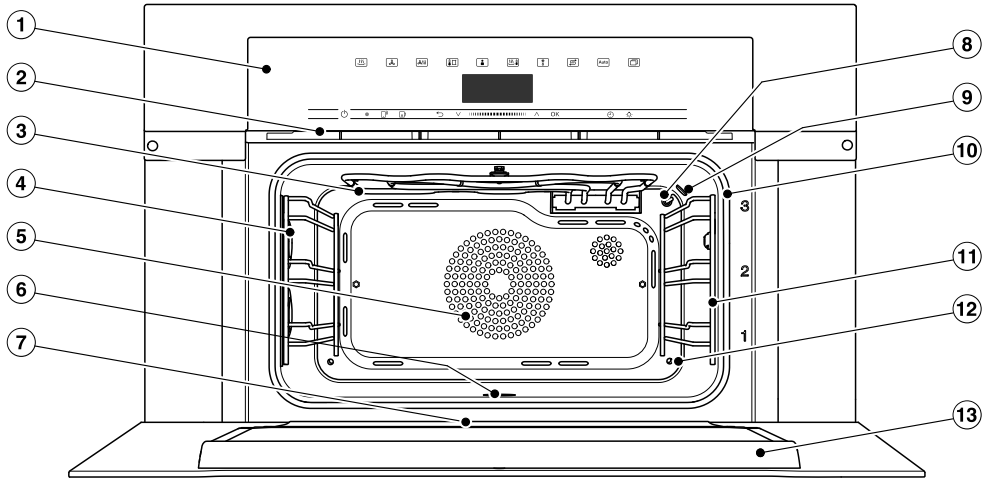

- ① Controls
- ② Vent
- ③ Browning/Broiling element
- ④ Oven interior lighting
- ⑤ Convection fan with heating element
- ⑥ Oven floor with bottom heater element and floor filter underneath it
- ⑦ Drip channel
- ⑧ Temperature sensor
- ⑨ Moisture sensor
- ⑩ Door seal
- ⑪ Side runners with 3 shelf levels
- ⑫ Steam inlet
- ⑬ Door

Overview

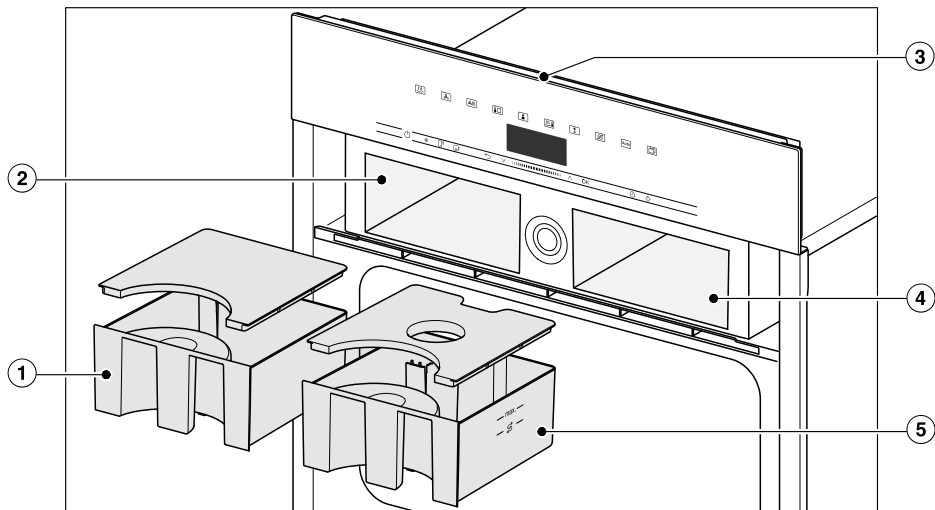

- ① Condensate container
- ② Condensate container compartment
- ③ Data plate
- ④ Compartment for water container
- ⑤ Water container

A list of the models described in these operating and installation instructions can be found on the back page.

Data plate

The data plate can be found at the top on the opened control panel.

Here you can find the model and serial number.

Have this information available if you need to contact Miele so that any issues can be rectified as quickly as possible.

Included accessories

The accessories supplied with your appliance, as well as a range of optional ones, are available to order from Miele (see "Optional accessories").

The perforated and solid cooking pans will be damaged by high temperatures!

Use them only in modes and programs that work exclusively with steam.

DGG 20

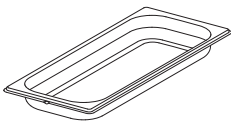

1 solid cooking pan
Gross capacity 0.64 gal (2.4 l)
Useable capacity 0.48 gal (1.8 l)
17 11/16" x 7 1/2" x 1 9/16" (WxDxH)
450 x 190 x 40 mm (WxDxH)

DGGL 20

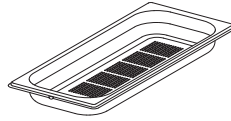

1 perforated cooking pan
Gross capacity 0.64 gal (2.4 l)
Useable capacity 0.48 gal (1.8 l)
17 11/16" x 7 1/2" x 1 9/16" (WxDxH)
450 x 190 x 40 mm (WxDxH)

Universal tray

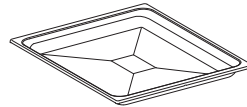

1 universal tray for baking, roasting and broiling

Wire rack









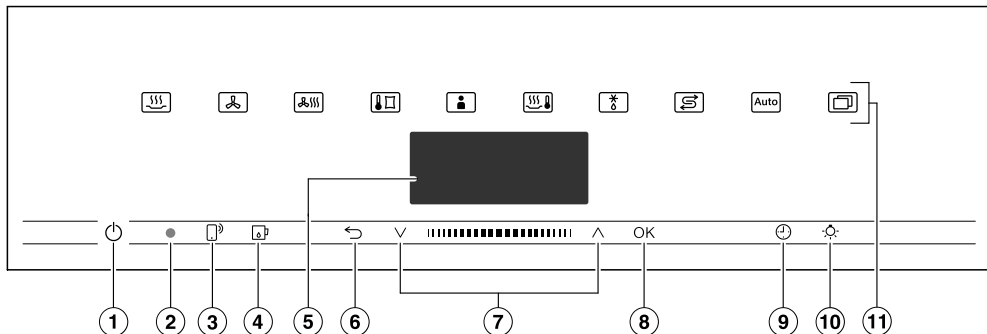

1 wire rack for baking, roasting and broiling

Descaling tablets

For descaling the steam oven

Control panel



- ① Recessed  On/Off button
For turning the steam oven on and off
- ② Optical interface
(for Miele Service only)
- ③  sensor button
For controlling the steam oven via your mobile device
- ④  sensor button
For opening and closing the control panel
- ⑤ Display
For displaying the time of day and information on operation
- ⑥  sensor button
For going back a step and for changing menu options during a cooking process
- ⑦ Navigation area with  and  arrow buttons
For scrolling through lists and for changing values
- ⑧ OK sensor button
For accessing functions and saving settings
- ⑨  sensor button
For setting a timer, the cooking duration, or the start or finish time for the cooking program
- ⑩  sensor button
For switching the oven interior lighting on and off
- ⑪ Sensor buttons
For selecting operating modes, automatic programs, and settings

On/Off button

The  On/Off button is recessed and reacts to touch.

Use this button to turn the steam oven on and off.

Display

The display is used for showing the time of day or information about operating modes, temperatures, cooking durations, MasterChef automatic programs, and settings.

After switching the steam oven on with the  On/Off sensor button, the main menu will appear, prompting you to Select operating mode.

Sensor buttons

The sensor buttons react to touch. Every tap of a sensor button is confirmed with an audible keypad tone. You can turn this keypad tone off using Additional  | Settings | Volume | Keypad tone.





If you want the sensor buttons to respond even when the steam oven is turned off, select the Display | Quick-Touch | On setting.

Sensor buttons above the display



For information on the functions and operating modes, see “Main and sub-menus”, “Settings”, “Automatic programs”, and “Further applications”.

Control panel

Sensor buttons under the display





Sensor button	Function
	<p>If you want to control the steam oven from your mobile device, you must have the Miele@home system, turn on the <i>Remote control</i> setting, and tap this sensor button. The sensor button then lights up orange and the <i>MobileStart</i> function is available.</p> <p>As long as this sensor button is illuminated, you can control the steam oven via your mobile device (see “Settings – Miele@home”).</p>
	<p>Use this sensor button to open and close the control panel (see “Description of functions – Control panel”).</p>
	<p>Depending on which menu you are in, this sensor button will take you back a level or back to the main menu.</p> <p>If a cooking program is in progress at the same time, use this sensor button to change values and settings such as the temperature or booster function for the program, or to cancel the program.</p>
	<p>In the navigation area, use the arrow buttons or the area between them to scroll up or down in the lists. The menu options will be highlighted one after the other as you scroll through them. The desired menu option must be highlighted before you can select it.</p> <p>You can change the values or settings that are highlighted by using the arrow buttons or the area between them.</p>
<i>OK</i>	<p>Functions highlighted in the display can be selected by touching the <i>OK</i> sensor button. The selected function can then be changed.</p> <p>Confirm with <i>OK</i> to save changes.</p> <p>If information appears in the display, select <i>OK</i> to confirm the message.</p>

Control panel

Sensor button	Function
	<p>If no cooking program is in progress, you can use this sensor button to set a timer (e.g., when boiling eggs) at any point.</p> <p>If a cooking program is in progress at the same time, you can set a timer, the cooking duration, and a start or end time for the program.</p>
	<p>Select this sensor button to turn the oven interior lighting on and off.</p> <p>Depending on the setting selected, the oven interior lighting turns off after 15 seconds or remains constantly turned on or off.</p>

Symbols

The following symbols may appear on the display:

Symbol	Meaning
	This symbol indicates that there is additional information and advice about using the appliance. Select <i>OK</i> to confirm the information.
	Timer
	A check indicates the option which is currently selected.
	Some settings, e.g., display brightness and signal tone volume, are selected using a segment bar.
	The system lock prevents the steam oven being switched on by mistake (see “Settings – Safety”).

Using the appliance

Use the \wedge and \vee arrow buttons or the **|||||** area between them in the navigation area to use the steam oven.

As soon as you reach a value, message, or setting you need to confirm, the *OK* sensor button will light up orange.

Selecting a menu option

- Touch the \wedge or \vee arrow buttons or swipe to the right or left in the **|||||** area until the desired menu option is highlighted.

Tip: If you press and hold the arrow button, the list continues scrolling automatically until you release the arrow button.

- Confirm your selection with *OK*.

Changing a setting in a list

- Touch the \wedge or \vee arrow buttons or swipe to the right or left in the **|||||** area until you reach the desired value or the desired setting is highlighted.

Tip: A \checkmark check will appear beside the current setting.

- Confirm with *OK*.

The setting is now saved. This will take you back to the previous menu.

Changing the setting with a segment bar

Some settings are represented by a **■■■■□□□□** bar made up of segments. If all of the segments are illuminated, the maximum value is selected.

If none of the segments are illuminated or if only one is, the minimum value is selected or the setting is turned off altogether (e.g., volume).

- Touch the \wedge or \vee arrow buttons or swipe to the right or left in the **|||||** area until you reach the desired setting.

- Confirm your selection with *OK*.

The setting is now saved. This will take you back to the previous menu.

Selecting an operating mode or function

The sensor buttons for the operating modes and functions (e.g., Additional ) are located above the display (see “Controls” and “Settings”).

- Touch the sensor button for the desired operating mode or function.

The sensor button on the control panel lights up orange.

- Under Additional , scroll through the lists until the desired menu option is highlighted.
- Set the values for the cooking program.
- Confirm with *OK*.

Changing the operating mode

You can change to another operating mode during a cooking program.

The sensor button for the previously selected operating mode lights up orange.

- Touch the sensor button of the new operating mode or function.

The new operating mode will appear on the display with its corresponding recommended values.

The sensor button for the new operating mode lights up orange.

Under Additional , scroll through the lists until you reach the desired menu option.

Entering numbers

Numbers that can be changed are highlighted.

- Touch the \wedge or \vee arrow buttons or swipe to the right or left in the  area until the desired number is highlighted.

Tip: If you press and hold an arrow button, the numbers continue scrolling automatically until you release the arrow button.

- Confirm with *OK*.

The changed number is now saved. This will take you back to the previous menu.

Entering letters

Letters are entered via the navigation area. It is best to select short names.

- Touch the \wedge or \vee arrow buttons or swipe to the right or left in the  area until the desired character is highlighted.

The character you have selected will appear in the top line of the display.

Tip: A maximum of 10 characters can be used.

You can delete the characters one at a time with .

- Select the rest of the characters.
- Once you have entered the name, select \checkmark .
- Confirm with *OK*.

The name is now saved.

Using the appliance

Activating MobileStart

- Select the  sensor button to activate MobileStart.

The  sensor button lights up. You can operate your steam oven remotely with the Miele app.

Directly operating on the steam oven takes priority over operating it via the remote-control function on the app.

You can use MobileStart as long as the  sensor button is lit up.

Control panel

The water container and the condensate container are located behind the control panel. The panel is opened and closed by touching the  sensor button. Before the control panel closes automatically, a note appears in the display, which you must confirm with *OK*.

The control panel is equipped with anti-trapping protection. If the control panel senses resistance when opening/closing, the process is canceled. Do not touch the upper edge of the door when the panel is opening and closing.

Water container

The maximum filling volume is 6 cups (1.4 l) and the minimum is 4 1/4 cups (1.0 l). There are markings on the water container. The upper marking must never be exceeded.

Water consumption depends on the type of food and the cooking duration. The water may need to be topped up during cooking. Water consumption is increased if the door is opened during cooking.

Fill the water container to the maximum level before each cooking program involving steam.



Condensate container

Condensate that collects in the appliance from cooking is pumped into the condensate container. The container has a maximum capacity of 6 cups (1.4 l).

Temperature

Some operating modes have a preset recommended temperature. The recommended temperature can be altered within the given range for an individual cooking program, a program stage, or for every time that program is used. You can alter the recommended temperature in 5°F/5°C increments, or 2°F/1°C increments in sous-vide cooking (see “Settings – Recommended temperatures”).

Moisture

The Combi Steam  operating mode and Reheat  application use a combination of oven heat and moisture. The moisture level can be selected within the given range for an individual program or a specific program stage.

Depending on the moisture setting, moisture or fresh air is supplied to the oven compartment. With the moisture setting = 0%, the maximum fresh-air supply is implemented and no moisture is supplied. With the moisture setting = 100%, there is no fresh-air supply and the moisture content is at its maximum.

Some food gives off moisture during the cooking process. This moisture from the food affects the amount of additional moisture needed. If the required amount of moisture is low, the steam generator may not be activated at all.

Description of functions

Cooking duration

Depending on the operating mode, you can set a cooking duration of between 1 minute and 10 or 12 hours.

The cooking durations of the MasterChef and maintenance programs are set at the factory and cannot be altered.

When cooking with steam, as well as for programs and applications with pure steam operation, the cooking duration does not begin until the set temperature is reached. It starts immediately for all other operating modes, programs, and applications.

Noises

A humming sound can be heard during operation and after turning off the steam oven. This noise does not indicate incorrect operation or an appliance fault. The noise is made by water being pumped through the system.

When the steam oven is in use, you will hear a blower noise.

Heating-up phase

The display shows the temperature in the oven compartment as it rises during the heating-up phase in all operating modes (exceptions: Maxi Broil, Broil).

The duration of the heating-up phase with steam cooking will depend on the quantity and temperature of the food. In general, the heating-up phase will last for approx. 7 minutes. It will be longer if you are cooking refrigerated or frozen food. The heating-up phase may also take longer when cooking at lower temperatures and when cooking with the Sous-vide  operating mode.

Cooking phase

The elapsing time left is shown in the display during the cooking phase. When cooking with steam, the cooking phase begins once the set temperature is reached. It starts immediately for all other operating modes, programs, and applications.

Steam reduction

With steam cooking and Combi-Steam, the steam-reduction function will turn on automatically at the end of a cooking program which uses a temperature within a certain temperature range. This is to prevent a large amount of steam escaping when the door is opened.

Steam reduction will appear in the display.

Steam reduction can be turned off (see “Steam reduction” under “Settings”). When steam reduction is turned off, a large amount of steam will escape when the door is opened.

Oven interior lighting

For energy-saving reasons, the oven interior lighting has been set at the factory to go out after the program has begun.

If you want it to stay on all the time the oven is on, you will need to alter the default setting (see “Lighting” under “Settings”).

If the door is left open at the end of a cooking program, the oven interior lighting will turn off automatically after 5 minutes.

The lighting can be switched on for 15 seconds by touching the  sensor button on the control panel.

Before first use

Miele@home

Your steam oven is equipped with an integrated WiFi module.

To use this feature, you will need:

- a WiFi network
- the Miele app
- a Miele user account You can create a user account via the Miele app.

The Miele@mobile app will guide you as you connect your steam oven to your home WiFi network.

Once your steam oven is connected to your WiFi network, you can use the app for a number of actions, including the following:

- Call up information on the operating status of your steam oven
- Retrieve information on cooking processes that are in progress
- Stop cooking programs that are in progress

Connecting your steam oven to your WiFi network will increase energy consumption, even when the steam oven is turned off.

Make sure that the signal of your WiFi network is sufficiently strong in the place where your steam oven is installed.

Availability of the WiFi connection

The WiFi connection shares a frequency range with other appliances (including microwave ovens and remote control toys). This can cause sporadic or even complete connection failures. Therefore, the availability of featured functions cannot be guaranteed.

Miele@home availability

The ability to use the Miele app depends on the availability of the Miele@home service in your country.

The Miele@home service is not available in every country.

For information about availability, please visit www.miele.com.

Miele App

The Miele App is available to download free of charge from the Apple App Store® or from the Google Play Store™.



Basic settings

You must make the following settings before starting up for the first time. You can change these settings again at a later time (see “Settings”).

 Danger of injury caused by hot surfaces.

The steam oven gets hot during operation.

For safety reasons, the steam oven may only be used when it has been fully installed.

The steam oven will turn on automatically when it is connected to the electricity supply.

Setting the language

- Select the desired language.
- Confirm with *OK*.

If you have accidentally selected a language that you don't understand, proceed as described in “Settings – Language ▾”.

Setting the location

- Select the required location.
- Confirm with *OK*.

Setting up Miele@home

Set up “Miele@home” will appear in the display.

- To set up Miele@home immediately, select *Continue* and confirm with *OK*.
- To set it up at a later date, select *Skip* and confirm with *OK*.
See “Settings – Miele@home” for information on setting up at a later date.
- To set up Miele@home immediately, select the connection method you want to use.

You will then be guided by the display and the Miele app.

Setting the date

- Set the year, then the month, and finally the day.
- Confirm with *OK*.

Setting the time

- Set the time of day in hours and minutes.
- Confirm with *OK*.

Before first use

Setting the water hardness

Your local water authority will be able to tell you the hardness of the water in your area.

More information can be found under in “Water hardness” under “Settings”.

- Set the water hardness level for your area.
- Confirm with *OK*.

Completing the commissioning process

- Follow any further instructions on the display.

The appliance is now ready for use.

Cleaning for the first time

- Remove any protective wrapping and stickers from the steam oven and accessories.



The appliance has undergone a function test in the factory. Residual water from this testing may have dripped from the lines into the oven cavity during transportation.

Cleaning the water container and condensate container

 Risk of injury caused by the control panel.

You could get caught in the panel as it opens or closes.

Do not touch the upper edge of the door when the panel is opening and closing.

- Turn the steam oven on using the  On/Off sensor button.
- Select the  sensor button to open the control panel.
- Remove the water container and condensate container. To do this, push the water container and condensate container upward slightly.
- Rinse the water container and condensate container by hand or in the dishwasher.
- Push the water container and condensate container back in again.
- Select the  sensor button to close the control panel.

The message **Press OK to close the control panel will appear.**

- Confirm with *OK*.

Cleaning the accessories/oven compartment

- Take all accessories out of the oven compartment.
- Wash the cooking containers by hand or in the dishwasher.

The universal tray and wire rack surfaces are treated with PerfectClean and must **only** be washed by hand. See “PerfectClean” under “Cleaning and care for the steam oven”.

- Clean the universal tray and the wire rack with a clean sponge and a solution of hot water and liquid dish soap.

The interior of the steam oven has been treated at the factory with a conditioning agent.

- To remove this, clean the oven compartment with a clean sponge and a mild solution of liquid dish soap and hot water.

Setting the correct boiling point for water

Before cooking food for the first time, you must adjust the steam oven to the boiling temperature of the water, which varies depending on the altitude of where the steam oven is located. This process also flushes out the components of the appliance that carry water.

This procedure **must** be carried out to ensure efficient functioning of your appliance.

Distilled or carbonated water or other liquids could damage the steam oven.

Only use cold, fresh drinking water (below 70°F (20°C)).

- Remove the water container and fill it up to the maximum marker.
- Push the water container into the appliance.
- Then run the steam oven for 15 minutes using the Steam Cooking  operating mode (212°F (100°C)). Proceed as described in “Operation”.

Setting the correct boiling point for water following a house move

If you move house, the boiling point for the water in the steam oven will need to be reset for the new altitude if this differs from the old one by 984 ft (300 m) or more. To do this, descale the appliance (see “Maintenance” under “Cleaning and care for the steam oven”).

Before first use

Heating up the steam oven

- Take all accessories out of the oven compartment if applicable.
- To remove the grease from the ring heater element, heat the steam oven up to 395°F (200°C) using the Convection Bake  operating mode for 30 minutes. Proceed as described in “Operation”.

 Danger of injury caused by hot surfaces.





The steam oven gets hot during operation. You could burn yourself on the heater elements, oven compartment, or side racks.

Use pot holders when working in the hot oven compartment.

The heater element will give off a slight smell when it is heated for the first time. The smell and any vapors given off will dissipate after a while and do not indicate a faulty connection or appliance.

It is important to ensure that the kitchen is well ventilated during this operation.

Settings overview

Menu option	Available settings
Language 	... deutsch english ... Location
Time	Show On* Off Night dimming Clock format 12 h 24 h* Set
Date	
Lighting	On "On" for 15 seconds* Off
Display	Brightness  QuickTouch On Off*
Volume	Buzzer tones Melodies*  Solo tone  Keypad tone  Melodies On* Off
Units	Weight g* lb/oz lb Temperature °C* °F
Keep warm	On Off*
Steam reduction	On* Off
Recommended temperatures	
Booster	On* Off
Water hardness	1°dH ... 15°dH* ... 70°dH



* Factory default



Settings

Menu option	Available settings
Automatic rinse	On* Off
Safety	Sensor lock On Off* System lock  On Off*
Miele@home	Activate Deactivate Connection status Set up again Reset Set up
Remote control	On* Off
RemoteUpdate	On* Off
Software version	
Demo Mode	Demo Mode On Off*
Factory default	Appliance settings Favorites Recommended temperatures

* Factory default

Opening the “Settings” menu

In the Additional  | Settings  menu, you can personalize your steam oven by adapting the factory default settings to suit your requirements.

- Select Additional .
- Select Settings .
- Select the setting you want.



You can check settings or change them.

You cannot change settings while a cooking program is in progress.

Language

You can set your language and location.

After selecting and confirming your choice, the language you have selected will appear on the display.

Tip: If you have selected the wrong language by mistake, select the  sensor button. Follow the  symbol to get back to the Language  submenu.

Time

Show

Select how you want the time of day to appear in the display when the steam oven is turned off:

- On
The time is always visible in the display.
If you also select the Display | Quick-Touch | On setting, all sensor buttons will react to touch straight away.
If you also select the Display | Quick-Touch | Off setting, the steam oven has to be turned on before it can be used.
- Off
The display appears dark to save energy. The steam oven has to be turned on before you can use it.
- Night dimming
To save energy, the time only shows on the display between 5:00 am and 11:00 pm. The display remains dark at all other times.

Clock format

The time of day can be displayed in the 24 or 12-hour format (24 h or 12 h).

Settings

Set

Set the hours and the minutes.



If there is a power failure, the current time of day will reappear once the power has been restored. The time of day is saved for approx. 150 hours.

If the steam oven has been connected to a WiFi network and signed into the Miele@mobile app, the time will be synchronized based on the location setting in the Miele@mobile app.

Date

Set the date.



Lighting

- On
The oven interior lighting is turned on during the entire cooking period.
- "On" for 15 seconds
The oven interior lighting turns off 15 seconds after a cooking program has begun. Press the  sensor button to turn the oven interior lighting on again for 15 seconds.
- Off
The oven interior lighting is turned off. Press the  sensor button to turn the oven interior lighting on for 15 seconds.

Display

Brightness

The display brightness is represented by a segment bar.

- 
Maximum brightness
- 
Minimum brightness

QuickTouch

Select how the sensor buttons should respond when the steam oven is switched off:

- On
If you have also selected the Time | Show | On or Night dimming setting, the sensor buttons will also respond when the steam oven is turned off.
- Off
Independently of the Time | Show setting, the sensor buttons only respond when the steam oven is switched on, as well as for a certain amount of time after switching it off.

Volume

Buzzer tones

If audible signals are turned on, an audible signal will sound when the set temperature is reached and at the end of a set time.

Melodies

At the end of a process, a melody will sound several times at intervals.

The volume of the melody is represented by a segment bar.

- ■■■■■■■■
Maximum volume

- □□□□□□
Melody is turned off

Solo tone

At the end of a process, a continuous tone will sound for a period of time.

The pitch of this continuous tone is represented by a segment bar.

- ■■■■■■■■■■■■■■■■■■■■
Maximum pitch

- □□□□□□□□□□□□□□
Minimum pitch

Keypad tone

The volume of the tone that sounds each time you tap a sensor button is represented by a segment bar.

- ■■■■■■■■
Maximum volume

- □□□□□□
Keypad tone is turned off

Melodies

The melody that sounds when you tap the  On/Off button can be turned on or off.

Units

Weight

For MasterChef programs, you can set the weight of food in grams (g), pounds/ounces (lb/oz) or pounds (lb).

Temperature

You can set the temperature in Celsius (°C) or Fahrenheit (°F).

Settings

Keeping warm

Using the Keep warm function, you can keep food warm at the end of a steam cooking program. Food is kept warm at a preset temperature for a maximum of 15 minutes. You can cancel the keeping warm process by opening the door.

Please note that delicate food, especially fish, can continue cooking while being kept warm.

- On
The Keep warm function is turned on. When cooking at a temperature of approx. 175°F (80°C) or above, this function becomes active after approx. 5 minutes. The food is kept warm at a temperature of 160°F (70°C).
- Off
The Keep warm function is turned off.

Steam reduction

The Steam reduction function stops excessive steam escaping when the door is opened.

- On
The steam-reduction function will turn on automatically at the end of a cooking program which uses a temperature of over approx. 175°F (80°C) (steam cooking) or 175–212°F (80–100°C) and 100% moisture (Combi-Steam). Steam reduction will appear in the display.
- Off
If steam reduction is turned off, the Keep warm function is also automatically turned off. When steam reduction is turned off, a large amount of steam will escape when the door is opened.

Recommended temperatures

If you often cook with temperatures that differ from the default, the recommended temperatures can be changed.

After you select this option, a list of oven modes will appear on the display.

- Select the operating mode you want to use.

The recommended temperature will appear together with the range within which it can be changed.

- Change the recommended temperature.
- Confirm with *OK*.

Booster

The **Booster** function is used to quickly preheat the oven.

- **On**
The **Booster** function is automatically turned on during the preheating phase of a cooking program. The browning/broiling element, ring heating element, and blower all preheat the oven compartment to the set temperature at the same time.
- **Off**
The **Booster** function is turned off during the preheating phase of a cooking program. Only the heating elements for the selected operating mode are used to preheat the oven compartment.

Settings

Water hardness

The steam oven must be adjusted to the local water hardness level to ensure that it works correctly and to ensure that descaling is carried out at the correct interval. The harder the water is, the more frequently the steam oven needs to be descaled.

Your local water authority will be able to tell you the hardness of the water in your area.

If you use bottled water, such as mineral water, make sure it is not carbonated. Adjust this setting depending on the calcium content. The calcium content is given on the label of the bottle in mg/l Ca²⁺ or ppm (mg Ca²⁺/l).

You can set the hardness level between 1 gpg (1°dH) and 73 gpg (70°dH). The hardness level is set to 16 gpg (15°dH) by default.

- Set the water hardness level for your area.
- Confirm with OK.

Water hardness		Calcium content mg/l Ca ²⁺ or ppm (mg Ca ²⁺ /l)	Setting
°dH	gpg		
1	1	7	1
2	2	14	2
3	3	21	3
4	4	29	4
5	5	36	5
6	6	43	6
7	7	50	7
8	8	57	8
9	9	64	9

Water hardness		Calcium content mg/l Ca ²⁺ or ppm (mg Ca ²⁺ /l)	Setting
°dH	gpg		
10	10	71	10
11	11	79	11
12	12	86	12
13	14	93	13
14	15	100	14
15	16	107	15
16	17	114	16
17	18	121	17
18	19	129	18
19	20	136	19
20	21	143	20
21	22	150	21
22	23	157	22
23	24	164	23
24	25	171	24
25	26	179	25
26	27	186	26
27	28	193	27
28	29	200	28
29	30	207	29
30	31	214	30
31	32	221	31
32	33	229	32
33	34	236	33
34	35	243	34
35	36	250	35
36	38	257	36
37–45	39–47	258–321	37–45
46–60	48–63	322–429	46–60
61–70	64–73	430–500	61–70

Automatic rinsing

Following a cooking program with steam, *Appliance rinsing* will appear in the display after the steam oven has been turned off.

This process flushes any remaining food deposits out of the system.

You can activate or deactivate the automatic rinsing process.

Safety

Sensor lock

The sensor lock prevents the cooking program from being turned off by mistake or settings from being changed. Once activated, the sensor lock prevents the sensor buttons and fields on the display from working for a few seconds after a program has been started, with the exception of the  On/Off button.

- On
The sensor lock is active. Touch *OK* sensor button for at least 6 seconds to deactivate the sensor lock for a short period of time.
- Off
The sensor lock is not active. All sensor buttons react to touch as normal.

System lock

The system lock prevents the steam oven being turned on by mistake.

You can still set a timer as well as use the *MobileStart* function when the system lock is active.

The system lock will remain activated even after a power outage.

- On
The system lock is now active. Before you can use the steam oven, touch the *OK* sensor button for at least 6 seconds.
- Off
The system lock is now deactivated. You can use the steam oven as normal.

Settings

Miele@home

The steam oven is a Miele@home-compatible appliance. Your steam oven is equipped ex-works with a WiFi communication module and is suitable for wireless communication.

There are a number of ways of connecting your steam oven to your WiFi network. It is recommended to connect your steam oven to your WiFi network using the Miele app or via WPS.

- Activate
This setting is only visible if Miele@home is deactivated. The WiFi function is reactivated.
- Deactivate
This setting is only visible if Miele@home is activated. Miele@home remains set up; the WiFi function is turned off.
- Connection status
This setting is only visible if Miele@home is activated. The display shows information such as the WiFi reception quality, network name, and IP address.
- Set up again
This setting is only visible if a WiFi network has already been set up. Reset the network settings and set up a new network connection straight away.
- Reset
This setting is only visible if a WiFi network has already been set up. The WiFi function is deactivated and the WiFi connection will be reset to the factory default. You must set up a new WiFi connection to be able to use Miele@home.
The network settings should be reset whenever a steam oven is being disposed of or sold, or if a used steam oven is being put into operation. This is the only way to ensure that all personal data has been removed and the previous owner will no longer be able to access the steam oven.
- Set up
This setting is only visible if no WiFi connection has been set up yet. You must set up a new WiFi connection to be able to use Miele@home.

Remote control

If you have installed the Miele app on your mobile device, have access to the Miele@home system, and have activated the remote-control function (On), you can use the MobileStart function and, for example, retrieve information about cooking processes that are in progress in your steam oven or end a process that is in progress.

The steam oven requires max. 2 W in networked standby.

Activating MobileStart

- Select the  sensor button to activate MobileStart.

The  sensor button lights up. You can operate your steam oven remotely with the Miele app.

Directly operating on the steam oven takes priority over operating it via the remote-control function on the app.

You can use MobileStart as long as the  sensor button is lit up.

RemoteUpdate

The RemoteUpdate menu option is only displayed and can only be selected if the requirements for using Miele@home have been met (see “Before using for the first time – Miele@home”).

The RemoteUpdate function is used for updating the software in your steam oven. If an update is available for your steam oven, it will automatically download it. Updates will not be installed automatically. They must be initiated manually.

If you do not install an update, you can continue to use your steam oven as usual. However, Miele recommends installing updates.

Activating/deactivating

The RemoteUpdate function is activated as standard. Available updates will be downloaded automatically but will only be installed if you initiate installation manually.

Deactivate RemoteUpdate if you do not want any updates to be downloaded automatically.

Settings

Running a RemoteUpdate

Information about the content and scope of an update is provided in the Miele app.

A message will appear in your steam oven display if a software update is available.

You can install the update immediately or postpone this until later. When the steam oven is turned on again, you will be reminded about the update.

Deactivate RemoteUpdate if you do not want to install the update.

The update may take several minutes.

Please note the following information about the RemoteUpdate function:

- You will only receive a message when an update is available.
- Once an update has been installed, it cannot be undone.
- Do not turn the steam oven off during the update. Otherwise, the update will be aborted and will not be installed.
- Some software updates can only be carried out by Miele Customer Service.

Software version

The software version menu option is for use by Miele Customer Service. You do not need this information for domestic use.

Demo Mode

This function enables the steam oven to be demonstrated in showrooms without heating up. Do not activate this setting for domestic use.

Demo Mode

If you have Demo mode activated, Demo mode is active. The appliance will not heat up will appear when you turn the steam oven on.

- On
Touch the *OK* sensor button for at least 4 seconds to activate Demo mode.
- Off
Touch the *OK* sensor button for at least 4 seconds to deactivate Demo mode. You can use the steam oven as normal.

Factory default

- Appliance settings
Any settings that have been altered will be reset to the factory default settings.
- Favorites
All Favorites will be deleted.
- Recommended temperatures
Any recommended temperatures that have been changed will be reset to the factory default settings.

Timer

Using the Timer function

The  timer can be used to time other activities in the kitchen, e.g., boiling eggs.

The timer can also be used at the same time as a cooking program for which the start and finish times have been set (e.g., as a reminder to stir the food or add seasoning, etc.).

- The maximum timer duration that can be set is 59 minutes and 59 seconds.

Setting the timer

If you have selected the Display | Quick-Touch | Off setting, you will need to turn the steam oven on before setting the timer. The timer can then be seen counting down on the display when the steam oven is turned off.

Example: you want to boil some eggs and set a timer of 6 minutes and 20 seconds.

- Select the  sensor button.
- Select Timer if a cooking program is in progress at the same time.

The prompt Set 00:00 min will appear.

- Using the navigation area, set 06:20.
- Confirm with *OK*.

The timer duration is now saved.

When the steam oven is turned off, the timer duration counts down in the display and  appears instead of the time of day.

If you are cooking at the same time,  and the timer duration will appear at the bottom of the display.

If you are in a menu, the timer will count down in the background.

At the end of the timer duration,  will flash, the time will start counting up, and an audible signal will sound.

- Select the  sensor button.
- If required, confirm with *OK*.

The audible signal will stop and the symbols on the display will go out.

Changing the timer

- Select the  sensor button.
- Select Timer if a cooking program is in progress at the same time.
- Select Change.
- Confirm with *OK*.

The timer appears.

- Change the time set for the timer.
- Confirm with *OK*.

The altered timer time is now saved.











Deleting the timer

- Select the  sensor button.
- Select Timer if a cooking program is in progress at the same time.
- Select Delete.
- Confirm with *OK*.

The timer is deleted.

Main and submenus



As different countries have different preferences when it comes to preparing food, the temperatures in °F and °C may not match. The temperatures are defined as they are specified in the table.

Menu	Recommended value	Range
Operating Modes		
Steam Cooking 	212°F (100°C)	105–212°F (40–100°C)
Convection Bake 	320°F (160°C)	85–435°F (30–225°C)
Combi Steam 		
Combi Steam + Convection Bake	340°F (170°C)	85–435°F (30–225°C)
Combi Steam + Surround	355°F (180°C)	85–435°F (30–225°C)
Combi Steam + Maxi Broil	Level 3	Level 1–3
Sous-vide 	150°F (65°C)	115–195°F (45–90°C)
Favorites 		
Reheat 	265 °F (130 °C)	250–285 °F (120–140 °C)
Defrost 	140°F (60°C)	120–140°F (50–60°C)
Descalc 		
Automatic programs 		
Additional 		
Convection Roast	375°F (190°C)	85–435°F (30–225°C)
Surround	355°F (180°C)	85–435°F (30–225°C)
Intensive	355°F (180°C)	120–435°F (50–225°C)

Main and submenus

Menu	Recommended value	Range
Additional 		
Bake	375°F (190°C)	210–395°F (100–200°C)
Browning	375°F (190°C)	210–435°F (100–225°C)
Maxi Broil	Level 3	Level 1–3
Broil	Level 3	Level 1–3
Convection Broil	395°F (200°C)	120–435°F (50–225°C)
Humidity Plus	320°F (160°C)	85–435°F (30–225°C)
Special Modes	–	–
Miele Mix & Match		
Blanch	–	–
Canning	195°F (90°C)	175–212°F (80–100°C)
Dehydrate	120°F (50°C)	85–160°F (30–70°C)
Proof	–	–
Sanitize Cookware	–	–
Sabbath Program	355°F (180°C)	120–435°F (50–225°C)
Warm-up Cookware	120°F (50°C)	120–175°F (50–60°C)
Keep warm	150°F (65°C)	105–212°F (40–100°C)

Main and submenus

Menu	Recommended value	Range
Additional 		
Maintenance		
Soak		
Drying		
Rinse		
Settings 		

Energy-saving tips

Cooking programs

- Remove all accessories from the oven that are not required for a cooking process.
- If a temperature range is given, it is best to select the lower temperature and check the food after the shortest cooking time given.
- Preheat the oven only if instructed to do so in the recipe or the cooking chart.
- Try not to open the door when cooking.
- Dark, matte tins are best for baking. They absorb the heat more effectively and transmit it to the mixture more quickly. Shiny materials such as stainless steel or aluminum reflect the heat and therefore can give a more uneven result. Do not cover the oven floor or the wire rack with heat-reflecting aluminum foil.
- Monitor cooking durations to avoid wasting energy when cooking. Set the cooking duration, or use a food probe if you have one.
- Most food can be cooked using Convection Bake  or Convection Roast. Because the blower distributes the heat in the oven compartment straight away, it allows you to use a lower temperature than you would with Surround. It also enables you to cook on multiple shelf levels at the same time.

- Convection Broil is the best operating mode for broiled dishes. Lower temperatures can be used than with other broil modes that use the maximum temperature setting.
- Whenever possible you should cook several dishes at the same time. Place them next to each other in the oven or on different shelf levels.
- Dishes which you are unable to prepare at the same time should, if possible, be cooked one after the other in order to make use of existing heat in the oven.

Customizing settings

- Select the Display | QuickTouch | Off setting for the control elements in order to reduce energy consumption.
- Select the Lighting | Off or "On" for 15 seconds setting for the oven interior lighting. You can turn the oven interior lighting on again at any time by tapping the  sensor button.

Energy-saving mode

The steam oven will turn itself off automatically to save energy if a program is not being run and controls have not been operated. The time of day will appear on the display or the display will remain dark (see "Settings").

Malfunction due to missing floor filter.

If the floor filter is missing, food deposits can get into the drain. The water cannot be pumped away.

Before each cooking program, check that the filter in the floor of the oven compartment is correctly fitted.

- Turn the steam oven on.

The main menu will appear.

- If you want to cook using a steam operating mode or with bursts of steam, fill the water container and insert it back in place.

Distilled or carbonated water or other liquids could damage the steam oven.

Only use cold, fresh drinking water (below 70°F (20°C)).

- Place the food in the oven.
- Select the operating mode you want to use.

The operating mode will appear in the display. Depending on which operating mode you have selected, the recommended values for temperature and moisture (if applicable) will appear one after the other.

- Adjust the recommended temperature, if necessary.
- Confirm with *OK*.

Otherwise, the recommended temperature will be accepted within a few seconds. You can change the temperature subsequently via the arrow button.

- Change the moisture setting if necessary.

- Confirm with *OK*.

The required and the actual temperature will appear and the heating-up phase will begin.

You will see the temperature rising on the display. An audible signal will sound when the set temperature is reached for the first time.

- After cooking, select the sensor button for the selected operating mode to end the cooking process.



Risk of injury due to hot steam.

When using a cooking program involving steam, a lot of hot steam can escape if the door is opened. The steam can cause burns.

Step back and wait until the hot steam has dissipated.

- Take the food out of the oven.

Operation

Cleaning the steam oven

- Remove the water container and condensate container and empty them as required.
- Turn the steam oven off.

Appliance rinsing appears after a cooking program involving steam.

- Follow the instructions on the display.

The rinsing process should be carried out every time to flush any remaining food deposits out of the system.

- Clean and dry the whole steam oven as described in “Cleaning and care for the steam oven”.
- Leave the appliance door open until the oven compartment is completely dry.

Refilling the water

If water needs replenishing during the cooking program, a tone will sound and the display will prompt you to refill the container with fresh water.

- Remove the water container and fill it with fresh water.
- Push the water container into the appliance.

The cooking program will continue.

Changing values and settings for a cooking program

Depending on the operating mode, as soon as a cooking program is in progress, you can use the ↵ sensor button to change the values or settings for this program.

- Select the ↵ sensor button.

Depending on the operating mode, the following settings appear:



- Temperature
- Moisture
- Duration
- Booster
- Preheat
- Crisp function

Changing values and settings

- Select the desired value or setting and confirm with *OK*.
- Change the value or setting and confirm with *OK*.

The cooking program will continue with the new values and settings.

Changing the temperature

You can permanently reset the recommended temperature to suit your cooking preferences by selecting Additional  | Settings  | Recommended temperatures.

- Select the  sensor button.
- Select Temperature and confirm with *OK*.
- Change the desired temperature via the navigation area.
- Confirm with *OK*.

The cooking program will restart with the new desired temperature.

Changing Moisture

- Select the  sensor button.
- Select Moisture and confirm with *OK*.
- Change the moisture level.
- Confirm with *OK*.

The program will continue to run at the new moisture level.

Setting additional durations

Cooking results can be adversely affected if there is a long delay between the food being placed in the oven and the start of cooking. Fresh food can change color and even spoil.

When baking, the cake mixture or dough can dry out, and the raising agents can lose their effectiveness. Select as short a time as possible until the start of the cooking process.

You have placed the food in the oven, selected a mode and the required settings such as the temperature.

By entering Duration, Finish at, or Start at via the  sensor button, you can automatically turn the cooking program off or on and off.

- Duration
Enter the required cooking duration for the food. The oven heating will turn off automatically once the cooking duration has elapsed. The maximum cooking duration that can be set depends on the mode that you have selected.
- Finish at
Specify when you want the cooking program to finish. The oven will turn off automatically at the time you have set.
- Start at
This function will only appear in the menu if you have set a Duration or Finish at time. With Start at, you have to specify when you want the cooking program to start. The oven will turn on automatically at the time you have set.

Operation

- Select the ⊕ sensor button.
- Set the required times.
- Confirm with *OK*.
- Touch the ↵ sensor button to return to the menu of the selected mode.

The steam-reduction function will turn on automatically at the end of a cooking program involving steam which uses a temperature of over approx. 175°F (80°C) (steam cooking) or 175–212°F (80–100°C) and 100% moisture (Combi-Steam).

- Wait until *Steam reduction* goes out in the display before opening the door and removing the food from the oven.

Changing set cooking durations

- Select the ⊕ sensor button.
- Select the time you want.
- Confirm with *OK*.
- Select *Change*, if required.
- Change the set time.
- Confirm with *OK*.
- Touch the ↵ sensor button to return to the menu of the selected operating mode.

These settings will be deleted in the event of a power outage.

Tip: You can also adjust the cooking duration directly via the navigation area.

Deleting the set cooking durations

In operating modes and applications where it is always necessary to set a cooking duration, you can only delete the set times for *Finish at* and *Start at*.

- Select the ⊕ sensor button.
- Select the time you want.
- Confirm with *OK*.
- Select *Delete*.
- Confirm with *OK*.
- Touch the ↵ sensor button to return to the menu of the selected operating mode.

If you delete *Duration*, the set durations for *Finish at* and *Start at* are also deleted.

If you delete *Finish at* or *Start at*, the cooking process will start using the cooking duration set.

Tip: You can also delete the cooking duration directly via the navigation area.

Canceling a cooking program

You can cancel a cooking program using the operating-mode sensor button that lights up orange or using the ↵ sensor button.

The oven heating and lighting will then turn off. Any cooking durations set will be deleted.

Touch the operating-mode sensor button to return to the main menu.

Canceling a cooking program without a set cooking duration

- Touch the sensor button for the selected operating mode.

The main menu will appear.

- **Or:** select the ↵ sensor button.
- Select *Cancel process*.
- Confirm with *OK*.

If you cancel a cooking program with steam via the ↵ sensor button, *Steam reduction* will appear if you have set a temperature above approx. 175°F (80°C) (steam cooking) or 175–212°F (80–100°C) and 100% moisture (Combi-Steam).

Canceling a cooking program with a set cooking duration

- Touch the sensor button for the selected operating mode.

Cancel program? appears.

- Select *Yes*.
- Confirm with *OK*.
- **Or:** select the ↵ sensor button.
- Select *Cancel process*.
- Confirm with *OK*.
- Select *Yes*.
- Confirm with *OK*.

Operation

Interrupting a cooking program

A cooking program is interrupted as soon as the door is opened. The oven heating turns off.

The set cooking duration is saved when cooking with steam as well as for programs and applications with pure steam operation.



Risk of injury due to hot steam.

When using a cooking program involving steam, a lot of hot steam can escape if the door is opened. The steam can cause burns.

Step back and wait until the hot steam has dissipated.



Risk of injury caused by hot surfaces and food.

The steam oven gets hot during operation. You could burn yourself on the heater elements, oven compartment, side racks, accessories, or food.

Use pot holders when placing food in the appliance or removing it and when working in the hot oven compartment.

When placing cooking containers in the oven or removing them, make sure that the hot food does not spill.

The cooking program will resume when the door is closed.

The steam oven will heat up again and the display will show the temperature in the oven compartment as it rises.

When cooking with steam as well as for programs and applications with pure steam operation, the time left only continues to count down once the set temperature has been reached.

In programs using 100% moisture and temperatures up to 212°F (100°C): the cooking program will finish early if the door is opened in the last minute of cooking (55 seconds remaining).

Preheating the oven

The **Booster** function is used to quickly preheat the oven compartment in some operating modes.



The **Preheat** function can be used with any oven mode and has to be switched on separately for each cooking program.

If you have set a cooking duration, it will only start to count down after the heating-up phase.

The oven compartment only needs to be preheated in a few cases.

- Preheat the oven compartment when cooking the following food:
 - cakes and pastries with a short cooking duration (approx. 30 minutes or less) as well as delicate items (e.g., sponge) with the **Surround** operating mode (without the **Booster** function)

Booster

The **Booster** function is switched on as the factory default setting for the following operating modes (Additional  | Settings  | **Booster** | On):

- Convection Bake 
- Convection Roast
- Surround

If you set a temperature above 210°F (100°C) and the **Booster** function is turned on, a rapid preheating phase heats the oven compartment to the set temperature. The browning/broiling element and the ring heating element come on together with the hot air blower.

Delicate items (e.g., sponge or cookies) will brown too quickly on the top if the **Booster** function is used.

Turn off the **Booster** function for these items.

Turning Booster on or off for a cooking program

If you have selected the **Booster** | On setting, you can turn the function off separately for a cooking program.

On the other hand, you can also turn on the function separately for a cooking program if you have selected the **Booster** | Off setting.

Example: you have selected an operating mode and the required settings such as the temperature. You want to turn off the **Booster** function for this cooking program.

- Select the  sensor button.
- Select **Booster** | Off.
- Confirm with **OK**.

The **Booster** function is turned off during the heating-up phase. Only the heater elements for the selected operating mode are used to preheat the oven compartment.

Operation

Preheat

You can place most dishes in the cold oven compartment to make use of the heat produced during the preheating phase.

If you have set a cooking duration, it will only start to count down when the target temperature is reached and you have placed the food in the oven.

Start the cooking program immediately without delaying the start time.

Turning on Preheat

The Preheat function has to be turned on separately for each cooking program.

Example: you have selected an operating mode and the required settings such as the temperature.

You want to turn on the Preheat function for this cooking program.

- Select the  sensor button.
- Select Preheat | On.
- Confirm with *OK*.

The following message will be displayed with a time: Place food in the oven at . The oven compartment is heated to the set temperature.

- As soon as you are prompted to do so, place the food in the oven.
- Confirm with *OK*.

Crisp function

The Crisp function function (moisture reduction) allows moisture to be removed from the oven as required during the entire cooking process or at times during the process.

It is a good idea to use this function when cooking items which have a moist topping, e.g., quiche, pizza, tray bakes with fresh fruit toppings, or muffins.

Poultry in particular gets a nice crisp skin with this function.

The Crisp function function can be used in the following operating modes:

- Convection Bake 
- Convection Roast
- Surround
- Intensive
- Bake
- Browning
- Convection Broil
- Humidity Plus

Turning on Crisp function

The Crisp function function has to be turned on separately for each cooking program.

You have selected an operating mode and the required settings such as the temperature.

You want to turn on the Crisp function function for this cooking program.

- Select the  sensor button.
- Select Crisp function | On.
- Confirm with *OK*.

The Crisp function function is turned on.

The Crisp function function can be switched off again at any time via the  sensor button.

Injecting bursts of steam

You can release bursts of steam during the cooking process in all oven operating modes. The number of bursts of steam is unlimited.

You can release a burst of steam as soon as *Burst of steam* is highlighted in the display.

Please wait until the heating-up phase is completed to allow the steam to be distributed evenly in the warm air in the oven.

- Select *OK*.

The burst of steam will be released.  appears in the display and *Burst of steam* goes out. This will take approximately 1 minute.

- Proceed as described to release further bursts of steam once *Burst of steam* appears in the display again.

General notes

The “General Notes” section contains general information. You will find more detailed information about particular foods and how to cook them in the other sections.

The advantages of cooking with steam

Almost all vitamins and minerals are retained as the food is not immersed in water.

Cooking with steam also retains the true taste of the food better than conventional cooking. We therefore recommend seasoning the food after it has been cooked. Food also retains its fresh, original color.

Suitable containers

Cooking containers

Stainless-steel cooking containers are provided with the steam oven. Other containers, in a variety of sizes, both perforated and solid, are available as optional extras (see “Optional accessories”). This enables you to choose the most suitable container for the meal you are preparing.

Use perforated cooking containers for **steam cooking** if possible. The steam can reach the food from all sides and the food is cooked evenly.

Your own dishware

You can also use your own dishware. However, please note the following:

- Dishware must be suitable for use in an oven and able to withstand steam. With plastic dishware, please check with the manufacturer that it is suitable for use in a steam oven.
- Thick-sided dishware made from porcelain, ceramic, or stoneware is not very suitable for using with steam. Due to its thick sides, it does not conduct heat well, meaning cooking durations will be considerably longer than those given in the charts.
- Place the dishware on the wire rack or in a cooking container. Depending on the size of the dishware, you can also place the wire rack on the floor of the oven compartment with the rack surface facing up and the dishware on top. You can also take the side racks out to make more room (see “Cleaning the side racks” under “Cleaning and care for the steam oven”).
- Ensure that there is a gap between the upper rim of the dishware and the top of the oven compartment to allow sufficient steam into the dishware.

Shelf level

You can select any shelf level. You can also cook on several levels at the same time. This will not alter the cooking duration.

When using more than one deep cooking container at the same time, it is best to offset them on their runners and to leave at least one level free in between them.

Always insert cooking containers and the rack between the rails of the shelf level supports so that they cannot tip.

Frozen food

The heating up phase for frozen food is longer than for fresh food. The greater the quantity of frozen food, the longer the preheating phase.

Temperature

During steam cooking, the temperature does not exceed 212°F (100°C). Almost all foods can be cooked at this temperature. Some types of food, such as berries, need to be cooked at lower temperatures to prevent them from bursting. See the relevant sections in these operating instructions for more details.

Cooking duration

During steam cooking, the cooking duration does not begin until the set temperature is reached.

In general, the cooking durations for cooking with steam are the same as for cooking food in a saucepan. More information about any factors which may affect the cooking duration is given in the relevant sections.

The quantity of food does not affect the cooking duration. 2 lb (1 kg) of potatoes will take the same time to cook as 1 lb (500 g) of potatoes.

Cooking with liquid

When cooking with liquid only fill the cooking pan $\frac{2}{3}$ full to prevent the liquid spilling when the cooking pan is removed from the oven.

Your own recipes - Steam cooking

Food and recipes which are prepared in pot or a pan can also be cooked in the steam oven. The cooking times in the steam oven will be the same. Please note that food will not be brown or crisp when cooking with steam.

General notes

Universal tray and wire rack

Use the universal tray with the wire rack placed on top of it, e.g., for roasting and broiling. During roasting, you can use the meat juices collected in the tray to make a gravy or sauce.

If you are using the universal tray with the wire rack on top, insert the universal tray between the rails of a shelf level and the wire rack will automatically slide in above them. When removing them from the oven, pull both out together.

Non-tip safety notches

The wire rack and universal tray have non-tip safety notches in the middle which prevent them being pulled right out when they only need to be partially pulled out. The tray and rack can then only be taken out of the oven by raising them upwards and then pulling them out.

Notes on the cooking charts

Follow the instructions on cooking durations, temperatures, and cooking notes.

Selecting the 🕒 cooking duration

The cooking durations given are guidelines only.

- We recommend selecting the shorter duration initially. You can cook for longer if necessary.

Steam cooking

Vegetables

Fresh food

Prepare fresh vegetables in the usual way, i.e. wash, clean and cut them up.

Frozen food

Frozen vegetables do not need to be defrosted beforehand unless they have been frozen together in a block.

Frozen and fresh vegetables which take the same length of time to cook can be cooked together.

If vegetables have frozen together in clumps, break these up before cooking with steam. Follow the manufacturer's instructions on the packaging regarding cooking duration.

Cooking pan

Food such as peas or asparagus spears, which have little or no space between them, will take longer to cook because the steam has less space to work in. For an even result, it is best to use a shallow container for these types of food, and only fill it about 1-2" (3-5 cm) deep. When cooking large quantities divide the food between 2 or 3 shallow containers rather than using one deep one.

Different types of vegetables which take the same length of time to cook can be cooked together in one cooking pan.

Use solid containers for vegetables which are cooked in liquid, e.g. cabbage.

Shelf level

When cooking vegetables with a distinctive color (e.g. beets) in a perforated container at the same time as cooking other foods in other containers, place the drip tray directly underneath the perforated container to catch any drips and therefore avoid any color transfer.

Cooking duration

The cooking duration depends on the size of the food and how well cooked you want it, just as it does with conventional cooking methods. Example:

White potatoes, cut into quarters:
approx. 17 minutes

White potatoes, cut in half:
approx. 20 minutes

Settings

Automatic programs  | Vegetables | ... |

or

Steam Cooking 

Temperature: 212°F (100°C)

Duration: see chart

Steam cooking

Vegetables	 [min]
Artichokes	32–38
Cauliflower, whole	27–28
Cauliflower, florets	3–8
Beans, green	3–10
Broccoli, florets	1–4
Chantenay carrots, whole	7–8
Chantenay carrots, halved	6–7
Chantenay carrots, chopped	4
Endive, halved	4–5
Chinese cabbage, chopped	3
Peas	3
Fennel, halved	10–12
Fennel, cut into strips	4–5
Kale, chopped	23–26
White potatoes, peeled whole	27–29
halved	21–22
quartered	16–18
Yukon Gold potatoes, peeled whole	25–27
halved	19–21
quartered	17–18
Idaho/Russet potatoes, peeled whole	26–28
halved	19–20
quartered	15–16
Kohlrabi, cut into batons	6–7
Pumpkin, diced	4–10
Corn on the cob	11–14
Chard, chopped	2–3

Steam cooking

Vegetables	 [min]
Bell pepper, diced or cut into strips	1
New potatoes, firm	30–32
Mushrooms	1
Leeks, sliced	2–3
Leeks, halved lengthways	6
Romanesco, whole	22–25
Romanesco, florets	5–7
Brussels sprouts	10–12
Beets, whole	53–57
Red cabbage, chopped	23–26
Black salsify, whole	9–10
Celery root, cut into batons	6–7
Green asparagus	3–7
White asparagus, whole	4–9
Carrots, chopped	3–6
Fresh Spinach	1–2
Napa cabbage, chopped	5–10
Celery, chopped	3–5
Rutabaga, chopped	6–7
White cabbage, chopped	12
Savoy cabbage, chopped	5–10
Zucchini, sliced	1
Snap peas	3–5

 Cooking duration

Fish

Fresh food

Prepare fresh fish in the usual way, i.e. clean, gut and filet.

Frozen food

Frozen fish should be slightly defrosted before cooking.

Preparing for use

Add some lemon or lime juice to fish before cooking. The citric acid helps the flesh stay firm.

It is not necessary to season fish when cooking with steam as this method retains the minerals which give the fish its unique flavor.

Cooking pans

If using a perforated pan, grease it first.

Shelf level

When cooking fish in a perforated container at the same time as cooking other types of food in other containers, place the container with the fish directly above the universal tray to catch any liquid and so avoid any transfer of tastes to other food.

Temperature

185–195°F (85–90°C)

For gently cooking delicate types of fish, such as sole.

212°F (100°C)

For cooking firmer types of fish, e.g. cod and salmon.

Also for cooking fish in sauce or stock.

Cooking duration

The cooking duration depends on the thickness and the consistency of the food, and not on the weight. The thicker the piece of food is, the longer cooking will take. A piece of fish weighing 1 lb (500 g) that is 1" (3 cm) thick will take longer to cook than a piece weighing 1 lb (500 g) and only 1/2" (2 cm) thick.

The longer fish cooks, the firmer its flesh will become. Use the cooking durations given in the chart. If you find that the fish is not cooked sufficiently only cook it for a few minutes more.

When cooking fish in sauce or stock, we recommend that you increase the cooking duration quoted by a few minutes.

Steam cooking

Tips

- Adding herbs and spices, such as dill, will help bring out the full flavor of the fish.
- Cook large fish in the swimming position. To help maintain the structure of the fish, place a small cup or similar upside down in the cooking container. Arrange the fish belly-side down over the cup.
- You can use any fish scraps, e.g., fish heads, bones, tails, etc., to make a **fish stock**. Place the fish scraps together with some mixed vegetables in a solid cooking container and add cold water. Cook at 212°F (100°C) for 60 to 90 minutes. The longer the cooking duration, the stronger the stock.
- Preparing fish **au bleu** is a method involving cooking the fish in water with vinegar, at different proportions depending on the recipe. It is important not to damage the skin of the fish. This method is suitable for cooking carp, trout, tench, eel, and salmon.

Settings

Automatic programs  | Fish | ... |

or

Steam Cooking 

Temperature: see chart

Duration: see chart

Steam cooking

Fish	🌡️ [°F (°C)]	🕒 [min]
Eel	212 (100)	5–7
Perch filet	212 (100)	8–10
Mahi mahi filet	185 (85)	3
Trout, 1/2 lb (250 g)	195 (90)	10–13
Halibut filet	185 (85)	4–6
Cod filet	212 (100)	6
Carp, 3 lbs (1.5 kg)	212 (100)	18–25
Salmon filet	212 (100)	6–8
Salmon steak	212 (100)	8–10
Rainbow trout	195 (90)	14–17
Basa filet	185 (85)	3
Tilapia filet	212 (100)	6–8
Haddock filet	212 (100)	4–6
Plaice filet	185 (85)	4–5
Monkfish filet	185 (85)	8–10
Sole filet	185 (85)	3
Turbot filet	185 (85)	5–8
Tuna filet	185 (85)	5–10
Pike perch filet	185 (85)	4

🌡️ temperature, 🕒 duration

Steam cooking

Meat

Fresh food

Prepare the meat as usual.

Frozen food

Meat should be thoroughly defrosted before cooking in the steam oven (see “Defrost” under “Special Modes”).

Preparation

For meat which needs to be seared before being cooked, e.g. for a stew, sear the meat in a pan on the cooktop first.

Cooking duration

The cooking time depends on the thickness and consistency of the food. The thicker the meat, the longer the cooking time. The thicker the piece of food is, the longer cooking will take. A piece of fish weighing 1 lb (500 g) that is 4" (10 cm) thick will take longer to cook than a piece weighing 1 lb (500 g) and only 2" (5 cm) thick.

Tips

- To retain the **flavor**, use a perforated cooking container. Place an unperforated cooking container underneath in order to collect the concentrate. You can use the concentrate to enhance your sauces or freeze it for later use.
- Boiling meat from chicken and beef as well as meat bones can be used to make a **strong stock**. Place the meat together with the bones and some mixed vegetables in a cooking container and add cold water. The longer the cooking duration, the stronger the stock.

Settings

Automatic programs  | Meat | ... |

or

Steam Cooking 

Temperature: 212°F (100°C)

Duration: see chart

Steam cooking

Meat	🕒 [min]
Beef flank, covered with water	110–120
Pork knuckle	135–140
Chicken breast filet	8–10
Ham hock	105–115
Prime rib, covered with water	110–120
Veal strips	3–4
Smoked pork slices	6–8
Lamb casserole	12–16
Poularde	60–70
Roulade of turkey	12–15
Turkey cutlet	4–6
Short rib, covered with water	130–140
Beef casserole	105–115
Whole chicken, covered with water	80–90
Top round	110–120

🕒 duration

Steam cooking

Rice

Rice swells when cooked and needs to be cooked in liquid. The proportion of rice to liquid will vary depending on the type of rice.

The rice absorbs all the liquid during the cooking process so that none of the nutrients are lost.

Settings

Automatic programs  | Rice | ... |

or

Steam Cooking 

Temperature: 212°F (100°C)

Duration: see chart

	Ratio Rice to liquid	 [min]
Basmati rice	1 : 1.5	15
Parboiled rice	1 : 1.5	23–25
Round grain rice		
Pudding rice	1 : 2.5	30
Risotto rice	1 : 2.5	18–19
Brown rice	1 : 1.5	26–29
Wild rice	1 : 1.5	26–29

 Cooking duration

Grains

Grain swells when cooked and needs to be cooked in liquid. The proportion of grain to liquid will vary depending on the type of grain.

Grain can be cooked whole or cracked.

Settings

Automatic programs  | Grains | ... |

or

Steam Cooking 

Temperature: 212°F (100°C)

Duration: see chart

	Ratio Grain to liquid	 [min]
Amaranth	1 : 1.5	15–17
Bulgur	1 : 1.5	9
Green spelt, whole	1 : 1	18–20
Green spelt, cracked	1 : 1	7
Oats, whole	1 : 1	18
Oats, cracked	1 : 1	7
Millet	1 : 1.5	10
Polenta	1 : 3	10
Quinoa	1 : 1.5	15
Rye, whole	1 : 1	35
Rye, cracked	1 : 1	10
Wheat, whole	1 : 1	30
Wheat, cracked	1 : 1	8

 Cooking duration

Steam cooking

Pasta/noodles

Dry pasta

Dry pasta swell when cooked and needs to be cooked in liquid. The liquid must cover the pasta by at least 1".

Cook pasta according to package directions.

Fresh food

Fresh pasta and noodles, such as those you can buy from the supermarket chilled counter, do not need to absorb water. Cook in a greased, perforated container.

Separate any pieces of pasta or noodles which have stuck together and spread them out in the cooking container.

Settings

Automatic programs  | Pasta | ... |

or

Steam Cooking 

Temperature: 212°F (100°C)

Duration: see chart

Fresh food	 [min]
Gnocchi	2
Round Knoepfli	1
Ravioli	2
Spaetzle	1
Tortellini	2

 Cooking duration

Dumplings

Ready-made dumplings in wrappers need to be covered completely with water. Otherwise they will not absorb enough water and will fall apart, even if steeped in water prior to cooking.

Cook fresh dumplings in a greased, perforated container.

Settings

Automatic programs  | Pasta | ... |

or

Steam Cooking 

Temperature: 212°F (100°C)

Duration: see chart

	 [min]
Steamed dumplings	30
Yeast dumplings	20
Boil-in-the-bag potato dumplings	20
Boil-in-the-bag bread dumplings	18–20

 Cooking duration

Steam cooking

Legumes

Soak legumes for at least 10 hours in cold water before cooking. Soaking makes the legumes more digestible and shortens the cooking duration required. Soaked legumes must be covered with liquid during cooking.

Lentils do not need to be soaked before cooking.

With unsoaked legumes, a certain ratio of pulses to liquid is required depending on type.

Settings

Automatic programs  | Legumes | ... |

or

Steam Cooking 

Temperature: 212°F (100°C)

Duration: see chart

Soaked	
	 [min]
Beans	
Kidney beans	55–65
Azuki beans	20–25
Black beans	55–60
Pinto beans	55–65
White beans	34–36
Peas	
Yellow peas	40–50
Green peas, shelled	27

 Cooking duration

Steam cooking

Unsoaked		
	Ratio Legumes to liquid	🕒 [min]
Beans		
Kidney beans	1 : 3	130–140
Azuki beans	1 : 3	95–105
Black beans	1 : 3	100–120
Pinto beans	1 : 3	115–135
White beans	1 : 3	80–90
Lentils		
Brown lentils	1 : 2	13–14
Red lentils	1 : 2	7
Peas		
Yellow peas	1 : 3	110–130
Green peas, shelled	1 : 3	60–70

🕒 Cooking duration

Steam cooking

Eggs

Use a perforated container to prepare boiled eggs in the steam oven.

The eggs do not need to be pierced before cooking as they are gradually warmed during the preheating phase and so do not burst when they are cooked with steam.

When using a solid container for making egg dishes such as scrambled eggs, remember to grease it first.

Settings

Automatic programs  | Eggs | ... |

or

Steam Cooking 

Temperature: 212°F (100°C)

Duration: see chart

	 [min]
Small soft medium hard	 3 5 9
Medium soft medium hard	 4 6 10
Large soft medium hard	 5 6–7 12
Extra large soft medium hard	 6 8 13

 duration

Fruit

Cook fruit in a solid container so that none of the juice is lost. If you wish to cook fruit in a perforated container, place a solid container directly underneath it to collect the juice.

Tip: You can use the collected juice to prepare a glaze.

Settings

Automatic programs  | Fruit | ... |

or

Steam Cooking 

Temperature: 212°F (100°C)

Duration: see chart

	 [min]
Apple chunks	1–3
Pear chunks	1–3
Cherries	2–4
Mirabelle plums	1–2
Nectarine/peach chunks	1–2
Plums	1–3
Quince, diced	6–8
Rhubarb pieces	1–2
Gooseberries	2–3

 duration

Sausage

Settings

Automatic programs  | Sausage

| ... |

or

Steam Cooking 

Temperature: 195°F (90°C)

Duration: see chart

Sausage	 [min]
Boiled sausage	6–8
Pork sausage	6–8
Veal sausage	6–8

 Cooking duration

Steam cooking

Shellfish

Preparation

Defrost frozen shellfish before cooking with steam.

Peel, clean and wash the shellfish.

Cooking pan

If using a perforated pan, grease it first.

Cooking duration

The longer shellfish are cooked, the tougher they become. Use the cooking durations given in the chart.

When cooking shellfish in sauce or stock, we recommend that you increase the cooking duration quoted by a few minutes.

Settings



Automatic programs  | Shellfish | ... |

or

Steam Cooking 

Temperature: see chart

Duration: see chart

	 [°F (°C)]	 [min]
Prawn	195 (90)	3
Shrimp	195 (90)	3
Jumbo shrimp	195 (90)	4
Small shrimp	195 (90)	3
Lobster	205 (95)	10–15
Large shrimp	195 (90)	3

 temperature,  duration

Mussels

Fresh food

 Danger of food poisoning from spoiled mussels.
Spoiled mussels can cause food poisoning.
Only cook mussels which are closed.
Do not eat mussels which have not opened after being cooked.

Steep fresh mussels in water for a few hours before cooking to rinse out any sand. Then scrub the mussels thoroughly to clean them.

Frozen food

Defrost frozen mussels before cooking.

Cooking duration

The longer mussels are cooked, the tougher they become. Use the cooking durations given in the chart.

Settings



Automatic programs  | Mollusks | ... |

or

Steam Cooking 

Temperature: see chart

Duration: see chart

	 [°F (°C)]	 [min]
Barnacles	212 (100)	2
Cockles	212 (100)	2
Bearded mussels	195 (90)	12
Scallops	195 (90)	5
Razor clams	212 (100)	2–4
Clams	195 (90)	4

 temperature,  duration

Steam cooking

Menu Cooking

Before cooking meals with the manual menu cooking function, turn off steam reduction (see “Steam reduction” under “Settings”).

When cooking a menu, you can combine different foods with different cooking durations, e.g., fish filet with rice and broccoli.

The food is placed in the steam oven compartment at different times so that each item is ready at the same time.

Shelf level

Place foods that produce a lot of liquid (e.g., fish) or have a distinctive color (e.g., beetroot) directly above the universal tray. This avoids any transfer of flavor or color to other food and prevents liquid dripping onto food below it.

Temperature

Whole meals should be cooked at a temperature of 212°F (100°C) as this is the temperature required to cook the majority of foods.

Do not cook a whole meal at the lowest temperature when different temperatures are required for different types of food, e.g. 185°F (85°C) for seabream and 212°F (100°C) for potatoes.

If the recommended cooking temperature for the food is 185°F (85°C), for example, try cooking it at 212°F (100°C) and testing the result. Some delicate types of fish with a soft structure, e.g. sole and plaice will become very firm when cooked at 212°F (100°C).

Cooking duration

If you are increasing the recommended temperature, shorten the cooking duration by approx. $\frac{1}{3}$.

Example

Food cooking durations

(see cooking charts in “Steam cooking”)

Parboiled rice	24 minutes
Tilapia filet	6 minutes
Broccoli	4 minutes

Calculation of set cooking durations:

24 minutes minus 6 minutes = 18 minutes (1st cooking duration: rice)

6 minutes minus 4 minutes = 2 minutes (2nd cooking duration: tilapia filet)

Remaining time = 4 minutes (3rd cooking duration: broccoli)

Cooking duration	24 min. – rice		
		6 min. – tilapia filet	
			4 min. – broccoli
Setting	18 min.	2 min.	4 min.

Cooking a whole menu

- Place the rice in the oven first.
- Set the first cooking duration: 18 minutes.
- After the 18 minutes, place the fish in the oven.
- Set the second cooking duration: 2 minutes.
- After the 2 minutes, place the broccoli in the oven.
- Set the third cooking duration: 4 minutes.

Sous-vide (vacuum) cooking

Always observe USDA/CFIA food safety guidelines.

This gentle cooking method allows food to be cooked slowly at a low, constant temperature in vacuum packaging.

With vacuum cooking, moisture does not evaporate and all nutrients and flavors are retained.

The result is flavorful and cooked evenly.

Only use food that is fresh and in good condition.

Ensure hygienic conditions and that food has not been out of the refrigerator too long, e.g. during transportation.

Use only heat-stable, boiling-resistant vacuum bags.

Do not cook food in the manufacturer's packaging, such as vacuum-packed frozen food. It is possible that an unsuitable vacuum bag was used.

Use the vacuum bag only once.

Vacuum-seal the food in a chamber system vacuum sealer only.

Important usage notes

For the best cooking results:

- Use herbs and spices more sparingly than with conventional methods because the impact on the taste of the food will be stronger.
You can also cook the food unseasoned and add seasoning after cooking.
 - The cooking duration is reduced when salt, sugar, and liquids are added.
 - The food becomes firmer if acidic ingredients such as lemon or vinegar are added.
 - Do not use alcohol or garlic as this can cause an unpleasant taste.
 - Only use vacuum bags that match the size of the food. If the vacuum bag is too big, too much air can remain inside.
 - If you want to cook several pieces of food in one vacuum bag, put them side by side in the bag.
 - If you want to cook food in several vacuum bags at once, put the bags side by side on the wire rack.
 - The cooking durations depend on the thickness of the food.
 - With high temperatures and/or long cooking durations, the appliance may run low on water. Check the display from time to time.
- Keep the door closed during the cooking program. Opening the door extends the cooking process and can change the cooking result.
 - Temperatures and cooking durations from sous-vide recipes cannot always be emulated exactly. Alter the settings to achieve the degree of cooking you want.

Sous-vide (vacuum) cooking

Tips

- In order to reduce cooking times, you can vacuum-seal food items 1–2 days before the cooking program. Store the vacuum-sealed food in the refrigerator at no more than 40°F (5°C). In order to preserve quality and flavor, the food should be cooked no later than 2 days afterward.
- Freeze liquids such as marinades before vacuum-sealing to prevent them from escaping from the bag.
- Fold the edges of the vacuum bag outward for filling. This will give you clean, perfect seams.
- If you do not want to eat the food straight after cooking, put it in iced water immediately and allow it to cool down completely. After this, store the food at temperatures no greater than 40°F (5°C). This way, you can retain the food's quality and flavor while keeping it fresh for longer.
Exception: poultry must be eaten straight after the cooking program.
- After cooking, cut the vacuum bag on all sides for easier access to the food.
- Briefly fry meat and firm types of fish (such as salmon) before serving. This will help to develop a roasted flavor.
- Use the stock or marinade of vegetables, fish, or meat to make a sauce.
- Serve the food on preheated plates.

Using the Sous-vide operating mode

- Rinse the food with cold water and dry it.
- Place the food in a vacuum bag and add spices or liquid if desired.
- Vacuum-seal the food in a chamber-system vacuum sealer.
- For the best cooking results, place the wire rack on shelf level 2.
- Place the vacuum-sealed food on the wire rack (next to each other if there are several bags).
- Select Sous-vide .
- Adjust the recommended temperature, if necessary.
- Confirm with OK.
- Set further settings as necessary (see “Operation”).

Possible causes for poor results

The vacuum bag has opened:

- The weld seam was not clean or stable enough and dissolved.
- The bag was damaged by a sharp bone.

The food has an unpleasant or strange taste:

- Incorrect storage of the food; the food was kept out of the refrigerator for too long.
- The food was contaminated with bacteria before it was vacuum sealed.
- Too much spice was used.
- The bag or weld seam were damaged.
- The vacuum was insufficient.
- The food was not immediately eaten or cooled after cooking.

Sous-vide (vacuum) cooking

The cooking durations given in the charts are guidelines only. We recommend selecting the shorter duration initially. You can cook for longer if necessary. The cooking duration only begins when the set temperature is reached.

Food	Added in advance		🌡️ [°F (°C)]	⌚ [min]
	Sugar	Salt		
Fish				
Cod filet, 1" (2.5 cm) thick		X	129 (54)	35
Salmon filet, 3/4"-1 1/4" (2-3 cm) thick		X	126 (52)	30
Monkfish filet		X	144 (62)	18
Pike perch filet, 3/4" (2 cm) thick		X	131 (55)	30
Vegetables				
Cauliflower florets, medium to large		X	185 (85)	40
Hokkaido squash, sliced		X	185 (85)	15
Kohlrabi, sliced		X	185 (85)	30
Asparagus, white, whole	X	X	185 (85)	22-27
Sweet potato, sliced		X	185 (85)	18
Fruit				
Pineapple, sliced	X		185 (85)	75
Apples, sliced	X		176 (80)	20
Baby bananas, whole			144 (62)	10
Peaches, halved	X		144 (62)	25-30
Rhubarb pieces			167 (75)	13
Plums, halved	X		158 (70)	10-12
Other				
Beans, white, soaked at a 1:2 ratio (beans to liquid)		X	195 (90)	240
Shrimp, peeled and deveined		X	133 (56)	19-21
Egg, whole			149-151 (65-66)	60
Scallops, removed from shell			126 (52)	25
Shallot, whole	X	X	185 (85)	45-60

🌡️ temperature, ⌚ duration

Sous-vide (vacuum) cooking

Food	Added in advance		🌡️ [°F (°C)]		🕒 [min]
	Sugar	Salt	Medium*	Done*	
Meat					
Duck breast, whole		X	151 (66)	162 (72)	35
Saddle of lamb (on the bone)			136 (58)	144 (62)	50
Beef tenderloin, 1 1/2" (4 cm) thick			133 (56)	142 (61)	120
Beef sirloin, 1" (2.5 cm) thick			133 (56)	–	120
Pork tenderloin, whole		X	145 (63)	153 (67)	60

🌡️ temperature, 🕒 duration

* Degree of doneness

The “Done” degree of doneness uses a higher core temperature than “Medium”. Results are not the same as “Well done” in traditional roasting methods.

Sous-vide (vacuum) cooking

Reheating

Only reheat brassicas, such as kohlrabi and cauliflower, together with a sauce. Without sauce, an unpleasant cabbage-like taste and gray-brown color may develop.

Food with a short cooking duration or which continues cooking during reheating, such as fish, is not suitable for reheating.

Preparation

Place the cooked food into ice water for about an hour directly after cooking. The fast cooling prevents the food from continuing to cook. The optimum cooking condition is thus retained. Then store the food in the refrigerator at a maximum of 40°F (5°C).

Please note that the quality of the food decreases the longer it is stored.

We recommend that you do not store the food in the refrigerator for longer than 5 days before reheating.

Settings

Sous-vide 

Temperature: see chart

Duration: see chart

Sous-vide (vacuum) cooking

Reheating in the Sous-vide operating mode

The durations specified in the chart are guidelines only. You can make the duration longer if necessary. The cooking duration only begins when the set temperature is reached.

Food	🌡️ [°F (°C)]		🕒 ² [min]
	Medium ¹	Done ¹	
Meat			
Saddle of lamb (on the bone)	136 (58)	144 (62)	30
Beef tenderloin, 1 1/2" (4 cm) thick	133 (56)	142 (61)	30
Beef sirloin, 1" (2.5 cm) thick	133 (56)	–	30
Pork tenderloin, whole	145 (63)	153 (67)	30
Vegetables			
Cauliflower florets, medium to large ³	185 (85)		15
Kohlrabi, sliced ³	185 (85)		10
Fruit			
Pineapple, sliced	185 (85)		10
Other			
Beans, white, soaked at a 1:2 ratio (beans to liquid)	195 (90)		10
Shallot, whole	185 (85)		10

🌡️ temperature, 🕒 duration

1 Degree of cooking

The “Done” degree of cooking uses a higher core temperature than “Medium”. Results are not the same as “Well done” in traditional roasting methods.

2 The durations apply to vacuum-sealed food with an initial temperature of approx. 40°F (5°C) (refrigerator temperature).

3 Reheat only in sauce.

Additional applications

Reheat

Always observe USDA/CFIA food safety guidelines.

To reheat food which was cooked using the sous-vide method, use the Sous-vide  operating mode (see “Reheating” under “Sous-vide”).

The steam oven is very effective at reheating food gently, without drying it out or cooking it further. The food reheats evenly and does not need to be stirred during the reheating process.

You can reheat individual dishes or plated meals which have been prepared previously (e.g. meat, vegetables and potatoes).

Suitable containers

Small quantities can be reheated on a plate, larger quantities should be placed in a cooking pan.

Duration

10–12 minutes are usually sufficient for one plate of food. More than one plate will need a little longer.

If you are reheating several plated meals one after the other, the reheating time can be reduced by around 5 minutes for the second and subsequent plates as the oven compartment will still be hot.

Moisture content

The more moist the food, the less moisture that needs to be added.

Tips

- Do not reheat large items, such as a whole roast. Divide it into portions and reheat these as plated meals.
- Compact items, such as stuffed bell peppers or roulades, should be cut in half.
- Reheat sauces separately. Exceptions are dishes such as baked ziti, which is cooked in sauce.
- Please note that breaded items, such as fried chicken, will not retain their crispness when they are reheated.

Food does not need to be covered before it is reheated.

Settings

Reheat 

or

Combi Steam  | Combi Steam + Convection Bake

Temperature: see chart

Moisture: see chart

Duration: see chart

Additional applications

The durations specified in the chart are guidelines only. We recommend selecting the shorter duration initially. You can make the duration longer if necessary.

Food	🔥 [°F (°C)]	∆∆ [%]	⌚* [min]
Vegetables			
Carrots Cauliflower Kohlrabi Beans	250 (120)	70	8–10
Side dishes			
Pasta Rice Potatoes, cut in half lengthways	250 (120)	70	8–10
Dumplings Mashed potato	285 (140)	70	18–20
Meat and poultry			
Sliced meat, 1/2" (1.5 cm) thick Roulades, sliced Goulash Lamb casserole Meatballs Chicken cutlets Turkey cutlets, sliced	285 (140)	70	11–13
Fish			
Fish filet Fish roulade, halved	285 (140)	70	10–12
Plated meals			
Spaghetti, in tomato sauce Pork roast, potatoes, and vegetables Stuffed bell peppers (cut in half), rice Chicken fricassee, rice Vegetable soup Creamed soup Clear broth Casserole	250 (120)	70	10–12

🔥 temperature, ∆∆ moisture, ⌚ duration

* These times apply to food heated on a plate.

Additional applications

Defrost

Always observe USDA/CFIA food safety guidelines.

It is much quicker to defrost items in the steam oven than at room temperature.

 Risk of infection from bacteria. Bacteria such as salmonella can cause life-threatening food poisoning.

It is particularly important to observe food hygiene rules when defrosting fish and meat, and in particular when defrosting poultry.

Do not use the liquid produced during defrosting.

Process the food as required as soon as it has been defrosted.

Temperature

140°F (60°C) is the best temperature for defrosting.

Exception: 125°F (50°C) for minced meat and game

Before and after defrosting

Remove any packaging before defrosting.

Exceptions: leave bread, biscuits, and cakes in their packaging as otherwise they will absorb moisture and become soft.

Allow food to stand at room temperature for a few minutes after defrosting. The standing time is necessary to allow the even distribution of heat from the outside to the inside.

Cooking containers

Use a perforated container with the universal tray underneath when defrosting food which will drip, such as poultry. This way food will not be lying in defrosted liquid.

Foods which do not drip can be defrosted in a solid cooking container.

Tips

- Fish does not need to be fully defrosted before cooking. Defrost so that the surface is sufficiently thawed to take herbs and seasoning. Depending on the thickness of the fish, 2–5 minutes is generally enough.
- When defrosting food which has frozen together, e.g., berries and meat portions, separate them half-way through the defrosting time.
- Do not refreeze food once it has thawed.
- Defrost frozen ready meals according to the instructions on the packaging.

Settings

Defrost 

or

Steam Cooking 

Temperature: see chart

Defrosting duration: see chart

Standing time: see chart

Additional applications

The durations specified in the chart are guidelines only. We recommend selecting the shorter defrosting duration initially. You can make the defrosting duration longer if necessary.

Frozen food	Quantity	🌡️ [°F (°C)]	🕒 [min]	⌚ [min]
Dairy products				
Sliced cheese	1/4 lb (125 g)	140 (60)	15	10
Quark	1/2 lb (250 g)	140 (60)	20–25	10–15
Cream	1/2 lb (250 g)	140 (60)	20–25	10–15
Soft cheese	1/4 lb (100 g)	140 (60)	15	10–15
Fruit				
Apple sauce	1/2 lb (250 g)	140 (60)	20–25	10–15
Apple chunks	1/2 lb (250 g)	140 (60)	20–25	10–15
Apricots	1 lb (500 g)	140 (60)	25–28	15–20
Strawberries	2/3 lb (300 g)	140 (60)	8–10	10–12
Raspberries/currants	2/3 lb (300 g)	140 (60)	8	10–12
Cherries	1/3 lb (150 g)	140 (60)	15	10–15
Peaches	1 lb (500 g)	140 (60)	25–28	15–20
Plums	1/2 lb (250 g)	140 (60)	20–25	10–15
Gooseberries	1/2 lb (250 g)	140 (60)	20–22	10–15
Vegetables				
Frozen in a block	2/3 lb (300 g)	140 (60)	20–25	10–15
Fish				
Fish filets	3/4 lb (400 g)	140 (60)	15	10–15
Trout	1 lb (500 g)	140 (60)	15–18	10–15
Lobster	2/3 lb (300 g)	140 (60)	25–30	10–15
Small shrimp	2/3 lb (300 g)	140 (60)	4–6	5
Ready meals				
Meat, vegetables, side dishes/ casserole/soup	1 lb (480 g)	140 (60)	20–25	10–15
Meat				
Roast meat, sliced	1/4 -1/2 lb (125–150 g) each	140 (60)	8–10	15–20

Additional applications

Frozen food	Quantity	🌡️ [°F (°C)]	🕒 [min]	⌚ [min]
Ground meat	1/2 lb (250 g)	125 (50)	15–20	10–15
	1 lb (500 g)	125 (50)	20–30	10–15
Goulash	1 lb (500 g)	140 (60)	30–40	10–15
	2 lb (1,000 g)	140 (60)	50–60	10–15
Liver	1/2 lb (250 g)	140 (60)	20–25	10–15
Saddle of hare	1 lb (500 g)	125 (50)	30–40	10–15
Saddle of venison	2 lb (1,000 g)	125 (50)	40–50	10–15
Cutlets/chops/sausages	1 3/4 lb (800 g)	140 (60)	25–35	15–20
Poultry				
Chicken	2 lb (1,000 g)	140 (60)	40	15–20
Chicken thighs	1/3 lb (150 g)	140 (60)	20–25	10–15
Chicken cutlet	1 lb (500 g)	140 (60)	25–30	10–15
Turkey drumsticks	1 lb (500 g)	140 (60)	40–45	10–15
Baked goods				
Puff pastries/yeasted goods	–	140 (60)	10–12	10–15
Cakes, cookies, and pastries	3/4 lb (400 g)	140 (60)	15	10–15
Bread/rolls				
Rolls	–	140 (60)	30	2
Rye bread, sliced	1/2 lb (250 g)	140 (60)	40	15
Whole grain bread, sliced	1/2 lb (250 g)	140 (60)	65	15
White bread, sliced	1/3 lb (150 g)	140 (60)	30	20

🌡️ temperature, 🕒 defrosting duration, ⌚ standing time

Miele Mix & Match

The Miele Mix & Match Special Mode is available to help with simple and uncomplicated preparation of plated meals. With this application, you can re-heat food that has already been cooked (convenience food) or assemble a portioned-out meal using fresh food and cook it on a plate.

During cooking, you have the choice between a crispy, browned result or gently cooked food with a succulent surface without additional browning.

Only use food that is completely hygienic. If you have any concerns, dispose of the food.

Containers

Use:

- a flat plate or a small ovenproof dish
- a deep bowl or a cup for food that requires liquid to be added

Baked goods, pizza, tarte flambée, etc., can be placed directly on the wire rack (with parchment paper if necessary).

The plastic containers for ready meals are not sufficiently heat-resistant.

Transfer ready meals into suitable cooking containers.

Additional applications

Tips for reheating plated meals

- For fried or gratin dishes, use **Crisp Reheating** and for baked or boiled dishes, use **Gentle Reheating**.
- Using **Crisp Reheating** ensures that only food that was crispy before reheating stays crispy.
- The food should not exceed a height of 3/4"-1" (2–2.5 cm). Transfer taller food into flat containers (e.g., casserole) or slice it into smaller pieces (e.g., roulades, bakes).
- Only reheat pasta mixed into a sauce.
- Droplets of water may have accumulated underneath the dishware. Dry the droplets of water before serving.

Tips for cooking plated meals

- You can easily make a sauce from the meat and fish stock: add 1 tsp of corn starch to the raw meat or fish before cooking. Stir the sauce with a fork until smooth before serving. You can also use 1 tsp of mashed potato powder (instant) or a pinch of guar gum instead of corn starch.
- If cooking durations for different foods are not the same, you can compensate for this by changing the size of the food: if the cooking duration is shorter, make the pieces larger (e.g., large cauliflower florets). If the cooking duration is longer, make the pieces smaller (e.g., diced potatoes).
- You can also compensate for differing cooking durations with layering: place food with a short cooking duration under a food with a long cooking duration or put them together as a small bake.
- To prevent the food from drying out, prepare your dish with a sauce or marinade. You can also use cheese or bacon.

Assembling a plated meal using various components

For a good cooking result, you must put together the individual components of the dish – such as meat, side dishes, and vegetables – so that a common setting can be selected for browning. This setting must be suitable for all elements of the meal, or at least conditionally suitable.

We recommend using the following procedure:

- Select a main ingredient based on the cooking charts, e.g., steak.
- Select other ingredients which have the corresponding settings for browning, e.g., green beans and rice.

Notes on the cooking charts

As well as information on portion sizes or the way the food needs to be processed prior to cooking, the cooking charts also provide tips on preparation.

The degree of browning is represented in the display by a bar with seven segments. Basically, the more segments that are filled, the longer the cooking duration.

You can use the icons to determine which setting is appropriate to brown the food:

Symbol	Meaning
—	Unsuitable
□	Conditionally suitable
■	Suitable

Additional applications

Using the Miele Mix & Match Special Mode

Food does not need to be covered while it is being cooked.

- Prepare the food as required.
- Select Additional  | Special Modes | Miele Mix & Match.
- If you are preparing food that is already **cooked**, select Gentle Reheating or Crisp Reheating.
- If you are preparing food that is **fresh** or just partially cooked, select Gentle Cooking or Crisp Cooking.
- Change the setting for browning if necessary.
- Confirm with *OK*.
- Place the food on the wire rack on shelf level 2.
- Confirm with *OK*.

You can start the cooking program immediately or delay the start.

- If by the end of a cooking program, the plated meal is not cooked enough for your taste, select *Cont. browning*.

Additional applications

Reheating food with the “Crisp Reheating” Special Mode

Food	Browning segment bar setting
Apple strudel, 1 3/4" (4 cm) thick, baked	___ _ _ _ <input type="checkbox"/> <input checked="" type="checkbox"/> <input type="checkbox"/> ___
Baked camembert, 0.8 oz (25 g), baked	___ _ _ _ <input checked="" type="checkbox"/> <input type="checkbox"/> ___
Baked camembert, 2.6 oz (75 g), baked	___ _ _ _ <input type="checkbox"/> <input checked="" type="checkbox"/> <input type="checkbox"/> ___
Baguette	___ <input type="checkbox"/> <input checked="" type="checkbox"/> <input type="checkbox"/> ___
Puff pastry canapés, baked	___ <input type="checkbox"/> <input checked="" type="checkbox"/> <input type="checkbox"/> <input type="checkbox"/> ___
Puff pastry pockets (spinach), baked	___ <input type="checkbox"/> <input checked="" type="checkbox"/> <input type="checkbox"/> ___
Börek, 1 1/4" (3 cm) thick, prebaked or baked	___ _ _ _ <input type="checkbox"/> <input type="checkbox"/> <input checked="" type="checkbox"/> <input type="checkbox"/> ___
Fried potatoes, 1/2" (1 cm) thick, precooked or cooked	___ _ _ <input type="checkbox"/> <input checked="" type="checkbox"/> <input type="checkbox"/> ___
Tofu patty ¹ , cooked	___ <input type="checkbox"/> <input type="checkbox"/> <input checked="" type="checkbox"/> <input type="checkbox"/> ___
Bread roll (wheat), prebaked	___ _ _ <input type="checkbox"/> <input checked="" type="checkbox"/> <input type="checkbox"/> ___
Bread roll (rye), prebaked	___ _ _ _ <input type="checkbox"/> <input checked="" type="checkbox"/> ___
Bread roll, baked, stored	___ _ _ _ <input type="checkbox"/> <input checked="" type="checkbox"/> ___
Cheeseburger, cooked	___ _ _ <input type="checkbox"/> <input checked="" type="checkbox"/> ___
Chili con carne ¹ , 3/4" (2 cm) thick, cooked	___ _ _ <input type="checkbox"/> <input checked="" type="checkbox"/> <input type="checkbox"/> ___
Ciabatta rolls, prebaked	___ _ _ _ <input checked="" type="checkbox"/> <input type="checkbox"/> ___
Ciabatta rolls, baked, stored	___ _ _ _ <input checked="" type="checkbox"/> <input type="checkbox"/> ___
Crêpe ¹ , cooked	___ _ _ <input checked="" type="checkbox"/> <input type="checkbox"/> ___
Tarte flambée, baked	___ <input type="checkbox"/> <input checked="" type="checkbox"/> <input type="checkbox"/> ___
Tarte flambée	___ <input type="checkbox"/> <input type="checkbox"/> <input checked="" type="checkbox"/> ___
Meat strips ¹ , precooked or cooked	<input type="checkbox"/> <input type="checkbox"/> <input checked="" type="checkbox"/> <input type="checkbox"/> <input type="checkbox"/> ___
Focaccia, 1 1/4"-1 1/2" (3-4 cm) thick, prebaked or baked	<input type="checkbox"/> <input type="checkbox"/> <input type="checkbox"/> <input checked="" type="checkbox"/> <input type="checkbox"/> ___
Meat patty ¹ (pork), 0.8 oz (25 g), cooked	<input type="checkbox"/> <input type="checkbox"/> <input checked="" type="checkbox"/> <input type="checkbox"/> <input type="checkbox"/> <input type="checkbox"/> ___
Meat patty ¹ (pork), 2.1 oz (60 g), cooked	___ _ _ _ <input type="checkbox"/> <input checked="" type="checkbox"/> <input type="checkbox"/> ___
Meat patty ¹ (pork), 3.5 oz (100 g), cooked	___ _ _ _ <input type="checkbox"/> <input type="checkbox"/> <input checked="" type="checkbox"/> <input type="checkbox"/> ___
Spring roll, 0.8 oz (25 g), cooked	___ _ _ _ <input type="checkbox"/> <input checked="" type="checkbox"/> <input type="checkbox"/> ___
Spring roll, 3.5 oz (100 g), cooked	___ _ _ _ _ <input type="checkbox"/> <input checked="" type="checkbox"/> <input type="checkbox"/> ___
Hot dog ¹ , prebaked	<input type="checkbox"/> <input type="checkbox"/> <input checked="" type="checkbox"/> <input type="checkbox"/> ___

Additional applications

Food	Browning segment bar setting
Kaiserschmarrn pancake ¹ , frozen, thawed	__ □ □ ■ □ □ __
Potatoes, Yukon Gold, sliced, cooked	__ __ □ ■ □ __ __
Potato pockets, baked	__ __ □ □ ■ □ __
Lasagna ¹ , 1 1/4" (3 cm) thick, cooked	__ _ _ _ ■ □ _ _ _
Naan ¹ , cooked	__ □ ■ □ __ _ _ _
Cheesy fresh pasta bake, 1 3/4" (4.5 cm) thick, precooked	__ __ □ ■ □ __ __
Pasta bake ¹ , 3/4" (2 cm) thick, cooked	__ _ _ _ ■ □ _ _ _
Pasta bake ¹ , 1 3/4" (4.5 cm) thick, cooked	__ _ _ _ □ ■ _ _ _
Pasta bake ¹ , 2 1/2" (6 cm) thick, cooked	__ _ _ _ _ □ ■ ■
Pancakes ¹ , cooked	■ □ _ _ _ _ _
Pancakes ¹	__ __ □ ■ □ __ __
Pita ¹ , prebaked	□ □ ■ □ _ _ _
Pizza, baked	□ □ ■ □ □ □ _
Poffertjes pancake	__ __ __ □ ■ □ __
Quiche, 0.8 oz (25 g), baked	□ □ ■ □ _ _ _
Quiche, 3/4" (2 cm) thick, baked	__ __ __ □ ■ □ __
Quiche, 1 1/2" (3.5 cm) thick, baked	__ _ _ _ □ ■ ■ □
Potato pancakes ¹ , cooked	__ _ _ _ ■ □ _ _ _
Hash browns, baked	__ __ __ □ ■ □ __
Schnitzel, cooked	__ __ □ ■ □ □ □
Taco shell, baked	□ □ ■ □ □ □ _
Toast Hawaii, cooked	__ □ ■ □ __ _ _ _
Grilled cheese, cooked	□ ■ _ _ _ _ _
Tortilla chips, baked, with cheese	__ □ ■ □ _ _ _
Tortilla wraps ¹ , prebaked or cooked, rolled in aluminum foil	□ □ ■ □ □ □ _

¹ is not crispy, only needs to be sufficiently heated (> 150°F (65°C)).

Additional applications

Cooking food with the “Crisp Cooking” Special Mode

Food	Cooking tips	Browning segment bar setting
Meat¹		
Bratwurst, 0.8 oz (25 g), boiled	–	— — — — □ □ ■ □
Bratwurst, 3.5 oz (100 g), boiled	Slashed	— — — — □ ■ □
Bratwurst, coarse, raw	Slashed, drizzled with a little oil	— — — — □ ■
Beef filet skewer, 1.7 oz (50 g) chunks, raw	Marinated, with bacon	□ ■ — — — —
Pork skewer, 1.7 oz (50 g) chunks, raw	Marinated, with bell pepper and onion	□ □ □ ■ □ — —
Meat patty, 2.1 oz (60 g), 1" (2.5 cm) thick	Ground meat, seasoned	— — — — □ ■ □
Chicken breast, 1 1/4" (3 cm) thick, raw	Wrapped in bacon, with salt and pepper	□ □ □ ■ □ — —
Chicken breast, 1 1/4" (3 cm) thick, raw	On its own, seasoned	— □ □ ■ — — —
Chicken breast, stuffed, raw	Seasoned, filling: spinach, crème fraîche	— □ □ ■ □ — —
Chicken skewer, 1.7 oz (50 g) chunks, raw	Marinated, with bell pepper and onion	□ □ ■ □ — — —
Chicken drumstick, raw	Marinated	— — — □ □ □ ■
Veal tenderloin, 1" (2.5 cm) thick, raw	Marinated, with sauce	■ — — — — —
Smoked pork cutlet, 1 1/2" (3.5 cm) thick, raw	–	— — □ ■ □ □ □
Smoked pork chop, 3/4" (2 cm) thick, raw	–	— □ □ ■ □ — —
Lamb chop, 3/4" (2 cm) thick, raw	Marinated	□ ■ □ □ — — —
Steak, 1 1/4" (3 cm) thick, raw	Marinated	— □ ■ □ — — —
Pork tenderloin, 1 1/2" (4 cm) thick, raw	Wrapped in bacon, with salt and pepper	□ □ ■ □ — — —
Pork chop, 1/2" (1.5 cm) thick, raw	Coated in breadcrumbs, drizzled with a little oil	— — — — — ■
Fish¹		
Halibut cutlet, 1 1/4" (3 cm) thick, raw	Marinated	□ ■ — — — —
Cod filet, 1 1/4" (3 cm) thick, raw	With butter and breadcrumb crust	— — — □ ■ □ —













Additional applications

Food	Cooking tips	Browning segment bar setting
Cod filet, 1 1/2" (3.5 cm) thick, raw	Marinated	■ □ □ _ _ _ _ _
Cod filet, stuffed, raw	Seasoned, filling: spinach, tomato	■ □ _ _ _ _ _
Salmon filet, 1 1/4" (3 cm) thick, raw	Seasoned	□ □ ■ □ □ _ _ _
Salmon cutlet, 1 1/4" (3 cm) thick, raw	Marinated	□ □ ■ □ □ _ _ _
Salmon skewer, 1.7 oz (50 g) chunks, raw	Seasoned	□ □ ■ □ □ _ _ _
Pollock filet, 1 1/4" (3 cm) thick, raw	Seasoned, topping: spinach, feta	■ □ _ _ _ _ _
Tuna filet, 1 1/4" (3 cm) thick, raw	Marinated	_ _ _ □ _ _ _ _
Tuna filet, 1 1/4" (3 cm) thick, raw	Seasoned, topping: tomato, cheese	_ _ _ □ ■ _ _ _
Catfish skewer, 1.7 oz (50 g) chunks, raw	Marinated, with bacon	_ □ □ □ ■ _ _ _
Vegetables		
Eggplant, 3/4" (2 cm) thick, raw	Marinated	_ _ _ _ ■ □ _ _ _
Cauliflower, large florets, raw	Salt, pepper, buttered bread-crumbs	□ □ ■ □ _ _ _ _
Broccoli, large florets, raw	Cheese sauce	□ ■ □ _ _ _ _ _
Bacon-wrapped string beans, raw	Wrapped in bacon slices, seasoned	_ _ _ ■ □ _ _ _ _
Cherry tomatoes, whole, raw	Marinated	■ □ □ □ _ _ _ _
Potatoes ² , 1/8" (3 mm) slices/chunks, raw	Butter, salt, or cheese	_ _ _ □ □ □ ■
Kohlrabi, 3/4" (2 cm) slices, raw	Salt, pepper, nutmeg	□ □ ■ □ _ _ _ _
Pumpkin, 3/4" (2 cm) chunks, raw	Salt, pepper, pumpkin seed oil	■ □ □ _ _ _ _ _
Corn on the cob, raw	Salt, butter	_ □ □ ■ □ _ _ _
Carrots, quartered/3/4" (2 cm) slices, raw	Salt, pepper, butter	□ □ ■ □ _ _ _ _
Bell pepper, large chunks, raw	Marinated	□ □ □ ■ □ _ _ _
Ratatouille, 3/4" (2 cm) chunks, raw	Tomato purée, seasoning, corn starch	■ □ _ _ _ _ _
Zucchini, 3/4" (2 cm) slices, raw	Marinated	_ □ □ ■ □ □ _ _

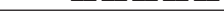
Additional applications

Food	Cooking tips	Browning segment bar setting
Pasta and rice		
Fresh pasta bake with meat, 1 3/4" (4.5 cm) thick, uncooked	Raw vegetables, sauce, cheese	
Fresh pasta, tortellini, precooked	–	
Lasagna, 1 1/4" (3 cm) thick, precooked	–	
Pasta bake, 3/4" (2 cm) thick, precooked	–	
Rice, brown rice, cooking duration 8 minutes, uncooked	Salt, 1:2 (rice:liquid)	
Rice, parboiled rice, cooking duration 8 minutes, uncooked	Salt, 1:1.5 (rice:liquid)	
Rice, parboiled rice, cooking duration 10–12 minutes, uncooked	Salt, 1:1.5 (rice:liquid)	
Rice, precooked	–	
Pizza etc.		
Baked camembert, 0.8 oz (25 g), frozen	Thawed	
Baguette, frozen	Thawed	
Baguette, prebaked	–	
Fried potatoes, precooked	–	
Bread roll, baked, stored	–	
Cheeseburger, prebaked	–	
Dates in bacon, raw	–	
Tarte flambée, uncooked	Chiller product	
Tarte flambée, uncooked	Top chilled pastry.	
Spring roll, 0.8 oz to 3.5 oz (25 g or 100 g), frozen	Thawed	
Grilled cheese, 3.2 oz (90 g), precooked	–	
Potato pockets, baked	–	
Potato pockets, frozen	Thawed	
Gnocchi, precooked	Butter, salt, cheese	
Potato pancakes, uncooked	Drizzled with a little oil	

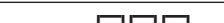
Additional applications

Food	Cooking tips	Browning segment bar setting
Schupfnudeln (potato dumplings), pre-cooked	–	
Tofu patty, 2.8 oz (80 g), cooked	–	
Pizza, baked	–	
Rye bread roll, frozen	Thawed	
Rye bread roll, prebaked	–	
Hash browns, baked	Butter, salt	
Hash browns, frozen	Thawed	
White roll, frozen	Thawed	
White roll, prebaked	–	
Onion tart, 1" (2.5 cm) thick, prebaked	–	
Desserts		
Kaiserschmarrn pancake, cooked	–	
Kaiserschmarrn pancake, frozen	Thawed	
Kaiserschmarrn pancake, uncooked	Mix mixture	

¹ Add 1 tsp corn starch to raw meat/fish.

² Yukon Gold

Additional applications

Food suitable for the “Gentle Cooking” Special Mode

Food	Cooking tip
Meat¹	
Large bockwurst/frankfurter sausage (pork), 3.5 oz (100 g), cooked	–
Beef filet skewer, 1.7 oz (50 g) chunks, raw	Marinated, with bacon
Pork skewer, 1.7 oz (50 g) chunks, raw	Marinated, with bell pepper and onion
Chicken breast, 1 1/4" (3 cm) thick, raw	On its own, seasoned
Chicken breast, stuffed, raw	Seasoned, filling: spinach, crème fraîche
Chicken skewer, 1.7 oz (50 g) chunks, raw	Marinated, with bell pepper and onion
Veal tenderloin, 1" (2.5 cm) thick, raw	Marinated, in sauce
Smoked pork, 3.5 cm thick, raw	–
Smoked pork chop, 3/4" (2 cm) thick, raw	–
Meatballs, 2.6 oz (75 g), raw	Ground meat, seasoned, in sauce
Fish¹	
Trout, whole, 3/4 lb (350 g), raw	Seasoned, filling: butter, herbs
Halibut cutlet, 1 1/4" (3 cm) thick, raw	Marinated
Cod filet, 1 1/2" (3.5 cm) thick, raw	Marinated
Cod filet, stuffed, raw	Seasoned, filling: spinach, tomato
Salmon filet, 1 1/4" (3 cm) thick, raw	Seasoned
Salmon cutlet, 1 1/4" (3 cm) thick, raw	Marinated
Salmon skewer, 1.7 oz (50 g) chunks, raw	Seasoned
Pollock filet, 6.3 oz (180 g)	Topping: spinach and crème fraîche
Tuna filet, 1 1/4" (3 cm) thick, raw	Marinated
Catfish skewer, 1.7 oz (50 g) chunks	Marinated, with bacon
Vegetables	
Cauliflower, large florets, raw	Seasoned
Broccoli, large florets, raw	Seasoned, with/without cheese sauce
Cherry tomatoes, whole, raw	Marinated
Fennel, 3/4" (2 cm) chunks/wedges, raw	Seasoned
Potatoes ² , quartered/in wedges, raw	Salt
Potatoes, Idaho/Russet, halved, raw	Salt

Additional applications

Food	Cooking tip
Kohlrabi, 3/4" (2 cm) slices, raw	Salt, pepper, nutmeg
Pumpkin, 1/2" (1.5 cm) chunks, raw	Salt, pepper, pumpkin seed oil
Corn on the cob, raw	Salt, butter
Carrots, quartered/3/4" (2 cm) slices, raw	Salt, pepper, butter
Bell pepper, large chunks, raw	Marinated
Ratatouille, 3/4" (2 cm) chunks, raw	Tomato purée, seasoning, corn starch
Brussels sprouts, whole, raw	Salt, pepper, nutmeg
Bacon-wrapped string beans	Wrapped in bacon slices, seasoned
Asparagus, spears, whole, raw	Salt, butter
Sweet potato, 1/2" (1.5 cm) chunks/wedges, raw	Salt
Zucchini, 3/4" (2 cm) slices, raw	Marinated
Pasta and rice	
Fresh pasta, tortellini, precooked	Sauce
Macaroni, short, uncooked	Salt, 1:3 (pasta:water)
Rice, basmati rice, cooking duration 10 minutes, uncooked	Salt, 1:2.5 (rice:liquid)
Rice, brown rice, cooking duration 8 minutes, uncooked	Salt, 1:2 (rice:liquid)
Rice, parboiled rice, cooking duration 8 minutes, uncooked	Salt, 1:2 (rice:liquid)
Rice, parboiled rice, cooking duration 10–12 minutes, uncooked	Salt, 1:2 (rice:liquid)
Rice, short-grain rice, cooked	–
Vermicelli, uncooked	Covered with stock
Pizza etc.	
Gnocchi, precooked	Salt, butter
Potato dumplings, in cooking bag, precooked	Covered with water
Mashed potato, instant	Mix powder according to packet instructions.
Mashed potato, cooked	–
Schupfnudeln (potato dumplings), precooked	Salt, butter

¹ Add 1 tsp corn starch to raw meat/fish.

² Yukon Gold

Blanching

Blanch fruit and vegetables before freezing them. Blanching helps maintain the quality of the produce when it is frozen.

Blanching vegetables also helps them retain their original color.

- Put the prepared vegetables (cleaned, washed, chopped, etc.) into a perforated cooking container.
- Once blanched, plunge the vegetables into ice cold water to cool them down quickly. Drain them well.

Settings

Additional  | Special Modes | Blanch

or

Steam Cooking 

Temperature: 212°F (100°C)

Blanching time: 1 minute

Canning

Always observe USDA/CFIA food safety guidelines.

Only use unblemished, fresh produce which is in good condition.

Glass jars

Use clean glass jars and accessories and check them for any defects. Glass jars with twist off lids or glass lids with a rubber seal are suitable.

Make sure that all the glass jars are the same size so that bottling is carried out evenly.

After you have filled the jars with the bottled produce, clean the glass rims with a clean cloth and hot water and then seal the jars.

Fruit

Sort fruit carefully, rinse it briefly but thoroughly and allow it to drain. Take great care when cleaning soft fruit as it is very delicate.

Remove any peel, stalks, cores or pits. Cut up large fruit. For example, cut apples into slices.

If you are bottling fruit with pits (e.g. plums, apricots) without removing the pits, pierce the fruit several times with a fork or wooden skewer as otherwise it will burst.

Additional applications

Vegetables

Rinse, clean, and chop vegetables.

Vegetables should be blanched before canning to help them retain their color (see “Blanching” under “Special Modes”).

Fill volume

Fill the glass jars with produce up to a maximum of 1 1/4" (3 cm) below the rim. Do not pack down as this would damage the cell walls of the produce. Bang the jar gently on a cloth to help distribute the contents evenly.

Use a sugar solution for fruit and a salt or vinegar solution for vegetables.

Tips

- Make use of residual heat by leaving the jars in the oven for 30 minutes after it has switched off.
- Then cover the jars with a cloth and allow to cool for approx. 24 hours.

Canning food

- Place a perforated container or the wire rack at level 1.
- Place the jars in the perforated container or on the wire rack. The jars must not touch each other.

Settings

Additional  | Special Modes | Canning or

Steam Cooking 

Temperature: see chart

Canning duration: see chart

Additional applications

The durations specified in the chart are guidelines only.

Food to be canned	🌡️ [°F (°C)]	🕒* [min]
Berries		
Currants	175 (80)	50
Gooseberries	175 (80)	55
Cranberries	175 (80)	55
Fruit with pits		
Cherries	185 (85)	55
Mirabelle plums	185 (85)	55
Plums	185 (85)	55
Peaches	185 (85)	55
Greengage plums	185 (85)	55
Fruit with pips		
Apples	195 (90)	50
Apple sauce	195 (90)	65
Quinces	195 (90)	65
Vegetables		
Beans	212 (100)	120
Broad beans	212 (100)	120
Pickling cucumbers	195 (90)	55
Beets	212 (100)	60

🌡️ temperature, 🕒 canning duration

* The canning times apply to 4 1/4 cups (1.0 l) jars. If using 2 cups (0.5 l) jars, reduce the duration by 15 minutes. If using 1 cup (0.25 l) jars, reduce the duration by 20 minutes.

Additional applications

Canning cakes

Batter, sponge, and yeast dough are suitable for canning. The cake has a shelf-life of 6 months.

Cooked cakes **containing fruit** are **not suitable for storage**. They must be consumed within two days.





Only use sterilized jars and accessories. The jars must be narrower at the bottom than at the top (mason jars). 1 cup (0.25 l) jars are the best for this purpose.

The jars need to have a canning ring, glass lid, and a spring lock clip to be sealed.



Make sure that all the glass jars are the same size so that canning is carried out evenly.

- Grease the inside of the jars with butter up to 1/2" (1 cm) below the rim.
- Sprinkle fine breadcrumbs inside the jars.
- Fill the jars $\frac{1}{2}$ to $\frac{2}{3}$ full with mixture (depending on recipe). Make sure the rim stays clean.
- Place the wire rack on shelf level 1.
- Place the **open** jars (all the same size) on the wire rack. The jars must not touch each other.
- Close the jars **immediately** after canning by clamping the glass lid down securely. Do not let the cakes cool down. If the mixture has risen above the rim, it can be pushed back down into the jar with the glass lid.

The durations specified in the chart are guidelines only. It is recommended to select the shorter duration initially. You can extend the duration if necessary.

Type of mixture	Operating mode	Step	🌡️ °F [°C]	ΔΔ [%]	🕒 [min]
Batter		–	320 (160)	–	35–45
Sponge		–	320 (160)	–	50–55
Yeast dough		1	85 (30)	100	10
		2	320 (160)	30	30–35

🌡️ temperature, ΔΔ moisture, 🕒 duration

 Surround,  Combi-Steam + Surround

Dehydrate

Only use the Dehydrate Special Mode or the Combi Steam  | Combi Steam + Convection Bake operating mode to dry food so that moisture can be dissipated.

- Cut the food into similar sized pieces.
- Place the pieces on the wire rack covered with parchment paper.

Tip: Bananas and pineapple are not suitable for drying in a combi steam oven.

Settings

Additional  | Special Modes | Dehydrate

Temperature: see chart

Drying time: see chart

or



Combi Steam  | Combi Steam + Convection Bake

Temperature: see chart

Moisture: 0%

Drying time: see chart

The durations specified in the chart are guidelines only. We recommend selecting the shorter drying time initially. You can make the drying time longer if necessary.

Food	 [°F (°C)]	 [h]
Apple, rings	160 (70)	6–8
Apricots, halved, pitted	140-160 (60–70)	10–12
Pears, sliced	160 (70)	7–9
Herbs	140 (60)	1.5–2.5
Mushrooms	160 (70)	3–5
Tomatoes, sliced	160 (70)	7–9
Citrus fruit, sliced	160 (70)	8–9
Plums, pitted	140-160 (60–70)	10–12

 temperature,  duration (hours)

Additional applications

Proofing

- Prepare the dough according to the recipe.
- Place the dough in an uncovered bowl in a perforated container or on the inserted wire rack.
Depending on the size of the bowl, you can also place the wire rack on the floor of the oven compartment with the rack surface facing up and place the bowl on top. If necessary, you can also remove the side racks.

Settings

Additional  | Special Modes | Proof
or

Steam Cooking 

Temperature: 85°F (30°C)

Moisture: 100%

Duration: as per recipe instructions

Sanitizing Cookware

The steam oven will sanitize baby bottles and other cookware. Check beforehand that the manufacturer guarantees all components are to be heat resistant to 212°F (100°C) and also steam resistant follow manufacturers instructions.

Dismantle, clean and thoroughly rinse baby bottles. Reassemble the bottles only after they have completely dried. This prevents recontamination.

- Place the individual items on the wire rack or in a perforated container (on their sides or with the opening facing downward) ensuring that they do not touch one another. This will allow hot steam to reach them from all sides.

Settings

Additional  | Special Modes | Sanitize
Cookware

Duration: 1 minute to 10 hours

or

Steam Cooking 

Temperature: 212°F (100°C)

Duration: 15 minutes

Sabbath Program

The Sabbath Program and Yom-Tov Special Modes help to support religious observance.

The steam oven heats up to the temperature you have set and maintains this temperature for a maximum of 24 hours (Sabbath Program) or 76 hours (Yom-Tov).

- Select Additional  | Special Modes.
- Select Sabbath Program.
- Select the Special Mode you want.

You will not be able to start the Special Mode if you have set a timer.

- Set the temperature.
- Confirm with *OK*.

The name of the Special Mode and the set temperature will appear on the display.

The oven heating will turn on around 30 seconds after you have closed the door.

The oven interior lighting will remain on during the entire cooking period.

Sabbath Program or Yom-Tov and the set temperature will appear permanently on the display.

The time of day will not appear. None of the sensor buttons respond (except for the On/Off  sensor button).

The message Do not open the door will appear.

After around 1 hour, this information will turn off from time to time. You can open the door when this message is **not** shown.

- Place the food in the oven.

The Sabbath Program Special Mode ends after 24 hours. The display will not change.

In both Special Modes, the steam oven turns off automatically after 76 hours.

- If you want to end the Special Mode prematurely, turn off the steam oven using the  On/Off sensor button.

Once a Special Mode has started, it cannot be changed or saved under Favorites.

Additional applications

Warm-up Cookware

Preheating the dishware means that food does not cool down as quickly.

Use heat-resistant dishware.

- Place the wire rack on shelf level 2 and place the dishware to be warmed on it. Depending on the size of the dishware, you can also place the wire rack on the floor of the oven compartment with the rack surface facing up and the dishware on top. If necessary, you can also remove the side racks.
- Select Additional  | Special Modes.
- Select Warm-up Cookware.
- Alter the recommended temperature if necessary and then set the time.

 Danger of injury caused by hot surfaces.

The steam oven gets hot during operation. You could burn yourself on the heater elements, oven compartment, side racks, or accessories.

Condensation may accumulate on the bottom of the dishware.

Use pot holders when removing dishware.

Keep warm

You can keep food warm in the oven compartment for up to 2 hours.

In order to maintain the quality of food, select the shortest possible time.

- Select Additional  | Special Modes.
- Select Keep warm.
- Place the food to be kept warm in the oven and confirm with *OK*.
- Alter the recommended temperature if necessary and then set the time.

Heating damp towels

- Moisten the towels and then roll them up.
- Place them beside one another in a perforated cooking container.

Settings

Automatic programs  | Special | Heat Damp Towels

or

Steam Cooking 

Temperature: 160°F (70°C)

Duration: 2 minutes

Dissolving Gelatine

- Soften **gelatine leaves** by leaving them in a bowl of cold water for 5 minutes. The gelatine leaves have to be fully covered with water. Remove the gelatine leaves from the bowl and squeeze them out. Empty the bowl. Place the squeezed gelatine leaves back in the bowl.
- Place **gelatine powder** in a bowl and add water according to the instructions on the packaging.
- Cover the bowl and place it in a perforated cooking container.

Settings

Automatic programs  | Special | Dissolve Gelatine

or

Steam Cooking 

Temperature: 195°F (90°C)

Cooking duration: 1 minute

Additional applications

Decrystallize honey

- Loosen the lid and place the jar of honey in a perforated cooking container.
- Stir the honey once during the process.

Settings

Automatic programs  | Special | Decrystallize Honey

or

Steam Cooking 

Temperature: 140°F (60°C)

Duration: 90 minutes (irrespective of the size of jar or the amount of honey in the jar)

Melting Chocolate

You can use the steam oven for melting any type of chocolate.

When using a cake glaze, place it in a perforated cooking container, leaving it in its packaging.

- Break the chocolate into small pieces.
- Place larger quantities in a solid cooking container and smaller quantities in a cup or a bowl.
- Cover the container or the dish with a lid or with foil that is resistant to temperatures up to 212°F (100°C) and to hot steam.
- Stir large quantities once during cooking.

Settings

Automatic programs  | Special | Melt Chocolate

or

Steam Cooking 

Temperature: 150°F (65°C)

Duration: 20 minutes

Making Yogurt

Always observe USDA/CFIA food safety guidelines.

To prepare yogurt, you will need milk and live culture or yogurt starter powder, e.g., from a health food store.

Use natural yogurt with live culture and without additives. Heat-treated yogurt is not suitable.

The yogurt must be fresh (short storage time).

You can use either unchilled long-life milk or fresh milk.

Long-life milk can be used as it is – no further preparation is required. Fresh milk must first be heated to 195°F (90°C) (do not boil it) and then cooled down to 95° (35°C). Fresh milk will give a better set than long-life milk.

The yogurt and milk should have the same percentage fat.

Do not move or shake the jars while the yogurt is fermenting.

Immediately after preparation, leave the yogurt to cool in the fridge.

The firmness, fat content, and cultures used in the yogurt starter all affect the consistency of homemade yogurt. Not all yogurts are equally suitable as yogurt starters.

Tip: When using yogurt enzyme, yogurt can be made from a milk/cream mixture. Mix 3 cups ($\frac{3}{4}$ liter) milk with 1 cup ($\frac{1}{4}$ liter) cream.

- Mix 3.5 oz (100 g) of yogurt with 4 $\frac{1}{4}$ cups (1 l) of milk or make up the mixture with yogurt starter, following the instructions on the packaging.
- Pour the mixture into glass jars and seal the jars.
- Place the sealed jars in a perforated cooking container or on the wire rack. The jars must not touch each other.
- Straight after the cooking duration has finished, place the jars in the refrigerator. Take care not to shake the jars unnecessarily.

Settings

Automatic programs Auto | Special | Make Yogurt

or

Steam Cooking

Temperature: 105°F (40°C)

Duration: 5:00 hours

Possible causes for poor results

Yogurt is not set:

Incorrect storage of the yogurt starter, too much time out of the refrigerator, packaging was damaged, milk was insufficiently heated.

Liquid has not been removed:

Jars were moved, yogurt was not cooled down quickly enough.

Yogurt is grainy:

Milk was overheated or in poor condition, milk and starter yogurt not evenly stirred.

Additional applications

Rendering Fat

The bacon will not become brown.

- Place the bacon (diced or rashers) in a solid cooking container.
- Cover the container with foil that is temperature-resistant up to 212°F (100°C) and resistant to steam.

Settings

Automatic programs  | Special | Render Fat

or

Steam Cooking 

Temperature: 212°F (100°C)

Duration: 4 minutes

Sweating Onions

Sweating means cooking the onions in their own juices, with the addition of a little fat if necessary.

- Cut the onions up into small pieces and place them in a solid cooking container with a little butter.
- Cover the container with foil that is temperature-resistant up to 212°F (100°C) and resistant to steam.

Settings

Automatic programs  | Special | Sweat Onions

or

Steam Cooking 

Temperature: 212°F (100°C)

Duration: 4 minutes

Juicing

This appliance is ideal for extracting juice from soft, firm, and hard fruit.

It is best to use overripe fruit, as the riper the fruit, the greater the quantity of juice produced. Very ripe fruit will also produce a more intense flavor.

Preparation

Sort and rinse the fruit. Cut out any blemishes.

Remove the stalks from grapes and cherries as these are bitter. Berries do not need to have their stalks removed.

Dice larger fruit such as apples into approximately 3/4" (2 cm) cubes. The harder the fruit, the smaller the pieces should be.

Tips

- Try experimenting with mild and tart flavors.
- The juice quantity and aroma are improved if sugar is added to the fruit and is allowed to soak in for several hours. We recommend 1/4–1/2 cup (50–100 g) sugar per 2 lbs (1 kg) of sweet fruit and 1/2–3/4 cup (100–150 g) sugar for 2 lbs (1 kg) tangy fruit.
- If you wish to bottle the juice rather than consume it straight away, while still hot pour it into clean bottles and seal immediately.

Extracting juice from fruit

- Put the prepared fruit (cleaned, washed, chopped etc.) into a perforated cooking container.
- Place a solid cooking container or the universal tray underneath in order to collect the juice.

Settings

Steam Cooking 

Temperature: 212°F (100°C)

Duration: 40–70 minutes

Additional applications

Fruit jam

Only use unblemished, fresh produce which is in good condition.

Glass jars

Only use sterilised jars with twist-off lids up to a maximum capacity of 1 cup (250 ml).

After pouring in the jam, clean the outside of the rim of the jar with a cloth and hot water.

Preparation

Sort fruit carefully, rinse it briefly but thoroughly and allow it to drain. Take great care when cleaning soft fruit as it is very delicate and squashes easily. Remove any stalks, cores or pits.

Purée the fruit as otherwise the preserve will not set. Add jam sugar to the fruit (according to packet instructions) and stir well.

For sweet fruit and berries you should also add some citric acid.

Making jam

- Fill jars maximum two-thirds full.
- Place the open jars in a perforated cooking container or on the wire rack.
- At the end of the cooking duration, take the jars out of the steam oven using pot holders. Leave them to stand for 1–2 minutes before sealing them with lids and then leave them to cool.

Settings

Combi Steam  | Combi Steam + Convection Bake

Temperature: 300°F (150°C)

Moisture: 0%

Duration: 35–45 minutes

Skinning Fruits and Vegetables

- Cut a cross in the top of tomatoes, nectarines etc. This will allow the skin to be removed more easily.
- Place the food in a perforated cooking container if cooking with steam, or a universal tray if using the broiler.
- To blanch almonds, it is important to plunge them into cold water as soon as they are taken out of the oven as otherwise the skin cannot be removed.

Settings

Additional  | Maxi Broil

Setting: 3

Duration: see chart

Food	 [min]
Bell Peppers	10
Tomatoes	7

 duration

Settings

Steam Cooking 

Temperature: 212°F (100°C)

Duration: see chart

Food	 [min]
Apricots	1
Almonds	1
Nectarines	1
Bell Peppers	4
Peaches	1
Tomatoes	1

 Duration

Preserving Apples

You can treat homegrown apples in the steam oven to increase the length of time for which you can store them. Once treated, the apples will keep for 5 to 6 months when stored in a dry, cool and well-ventilated place. This method is only suitable for apples and not for other types of fruit.

Settings

Automatic programs  | Fruit | Apples | Whole

or

Steam Cooking 

Temperature: 125°F (50°C)

Preserving time: 5 minutes

Preparing custard royale

- Stir 6 eggs into 1 1/2 cup (375 ml) milk (do not beat into a foam).
- Season the egg/milk mixture and pour into a solid cooking container greased with butter.

Settings

Steam Cooking 

Temperature: 212°F (100°C)

Duration: 4 minutes

Automatic programs

With the wide range of automatic programs, you can achieve excellent results with ease.

Categories

The automatic programs  are sorted into categories to provide a better overview. Simply select the appropriate automatic program for the type of food you are cooking and follow the instructions on the display.

Using automatic programs

- Select Automatic programs .

A list will appear.

- Select the food category you want.



The automatic programs available for the category selected will then appear.

- Select the automatic program that you want to use.
- Follow the instructions on the display.

Tip: Use  Info to display information such as how to place or turn the food depending on the cooking process.

Usage notes

- The degree of cooking and browning are represented by a bar with seven segments. You can set the desired degree of cooking or browning using the navigation area.
- The weights specified in the automatic programs refer to the weight per piece. For example, you can cook just one piece of salmon weighing 1/2 lb (250 g) or 10 pieces of salmon, each weighing 1/2 lb (250 g), at the same time.

- The steam oven compartment needs to cool to room temperature before starting an automatic program.
- When you place food in the hot oven compartment, be careful when opening the door. Hot steam may escape. Step back and wait until the steam has dissipated. Avoid contact with hot steam, and do not touch the hot oven compartment walls. Danger of burning and scalding.
- Please refer to recipes for information on suitable baking containers.
- For some automatic programs, the start or end time can be delayed using Start at or Ready at. The individual cooking stages of the automatic program are listed under the  Display cooking stages menu option.
- If by the end of an automatic program the food is not cooked enough for your taste, select Continue cooking or Continue baking.
- Automatic programs can also be saved as Favorites. To do this, select the  sensor button after an automatic program has finished.

You can create and save up to 20 of your own programs.

- You can combine up to 9 cooking stages to accurately program your favorite or most frequently used recipes. In each cooking stage, you can select settings such as the operating mode, temperature, and cooking duration.
- You can enter a program name for your recipe.

When you next select the program, it will start automatically.

There are different ways of creating a Favorite:

- At the end of an automatic program or Special Mode, save it as a Favorite.
- After running a program with a set duration, save it.

Then name the program.

Creating a Favorite

- Select Favorites .
- Select Create program.

You can now specify the settings for the first cooking stage.

Follow the instructions on the display:

- Select and confirm the settings.

If you select the Preheat function, first complete the first cooking stage. Use Add cooking stage to then add another cooking stage where you set a cooking duration. Only then can you save or start the program.

- If required, select Additional parameters to switch the Booster function and Crisp function on or off.
- Select Complete cooking stage.

All settings for the first cooking stage have now been set.

More cooking stages can be added, for example, if you would like to add another operating mode to follow the first.

- If additional cooking stages are required, select Add cooking stage and proceed as you did for the first cooking stage.

If you want to check the settings or to change them at a later date, select the cooking stage in question.

- When you have finished setting the cooking stages, select Save.
- Enter the program name.
- Select ✓.

Favorites

A message will appear on the display confirming that the name has been saved.

- Confirm with *OK*.

You can start the saved program immediately, delay the start, or change the cooking stages.

Starting Favorites

- Place the food in the oven.
- Select Favorites .
- Select the program you want to use.
- Select *Allow*.

Depending on the program settings, the following menu options will appear on the display:

- Start now
The program will start immediately.
The oven heating will turn on immediately.
- Finish at
You can set the time at which the cooking program should end. The oven will turn off automatically at the time you have set.
- Start at
You can set the time at which the cooking program should start. The oven will turn on automatically at the time you have set.
- Display cooking stages
A summary of your settings will appear on the display.
- Show actions
The required actions, e.g., placing the food in the oven, will appear on the display.

- Select the menu option you want.

The selected program will begin automatically right away or at the time set.

Use  *Info* to display information such as how to place or turn the food depending on the cooking process.

- At the end of the program, select the  sensor button.

Changing cooking stages

Cooking stages in an automatic program that have been saved under a different name cannot be changed.



- Select Favorites .
- Select the program you want to change.
- Select Change cooking stages.
- Select the cooking stage that you want to change or Add cooking stage to add another cooking stage.
- Select and confirm the settings.
- If you want to start the modified program without changing it, select Start program.
- Select Save when you have changed all the settings.

A message will appear on the display confirming that the name has been saved.

- Confirm with *OK*.

The saved program has been changed and you can start it immediately or delay the start.

Changing the name

- Select Favorites .
- Select the program you want to change.
- Select Change name.
- Change the program name.
- Select .

A message will appear on the display confirming that the name has been saved.



- Confirm with *OK*.

The program has been renamed.

Deleting a Favorite

- Select Favorites .
- Select the program you want to delete.
- Select Delete program.
- Confirm the request with *Yes*.

The program is deleted.

Go to Additional  | Settings  | Factory default | Favorites to delete all Favorites at the same time.

Baking

Handling and cooking food correctly is essential for maintaining good health.

Cakes, pizzas, and French fries should be cooked until golden, not dark brown.

Always observe USDA/CFIA food safety guidelines.

Baking tips

- Set a cooking duration. If used for baking, do not delay the start for too long. Otherwise the cake mixture or dough will dry out, and the raising agents will lose their effectiveness.
- Generally, you can use the wire rack, universal tray, and any type of bakeware made of heat-resistant material.
- Always place bakeware on the wire rack.
- Always cook frozen goods such as cakes, pizza, or baguettes on the wire rack.

Very high temperatures can cause the universal tray to distort to such an extent that the tray cannot be taken out of the oven compartment.

- Small items of frozen food such as oven chips or potato croquettes can be cooked on the universal tray. Turn these frozen food items several times during cooking.
- Bake on a maximum of two levels at the same time. When baking cakes with a moist topping, only bake on one level.

Using parchment paper

Miele accessories, e.g., the universal tray, are treated with PerfectClean (see “Cleaning and care for the steam oven”). Surfaces treated with PerfectClean generally do not need to be greased or covered with parchment paper.

- Use parchment paper when cooking:
 - lye mixtures because anything prepared using a lye containing sodium hydroxide can damage the PerfectClean surface
 - mixtures with a high egg-white content, such as sponge, meringue, and macaroons, as these can easily stick
 - puff pastry or strudel dough
 - frozen food on the wire rack
 - small items of frozen food such as oven chips or potato croquettes on the universal tray

Tips for baking

- Dark bakeware is best for baking. Avoid using bright, thin-walled pans made from a shiny material as they give an uneven or poor browning result. In certain unfavorable conditions, the food will not cook properly.
- Place cakes in rectangular bakeware on the wire rack with the longer side across the width of the oven for optimum heat distribution and even results.
- When cooking frozen food such as chips, croquettes, cakes, pizza, and baguettes, select the medium temperature quoted on the manufacturer's packaging.
- If a range is specified for the cooking duration, check whether the food is cooked after the shortest duration. Stick a wooden skewer into the food. If it comes out clean without any batter/dough on it, the food is done.

Notes on the operating modes

You can find an overview of all the operating modes with their recommended values in "Main and submenu".

Combi Steam

This operating mode uses a combination of oven heat and moisture. The addition of steam prevents the surface of the food from drying out. Bread, bread rolls, and puff pastry have a shiny and crispy crust.

You can choose between different types of heating:

- Combi Steam + Convection Bake
- Combi Steam + Surround
- Combi Steam + Maxi Broil

It is recommended to bake bread and bread rolls in several cooking stages: the shine is created during the first cooking stage thanks to the bursts of steam (maximum moisture, low temperature). Browning takes place in the next cooking stage with high moisture and a high temperature. It is then dried with reduced moisture and a medium to high temperature.

Tip: Recipes and other information can be found in the Miele App.

Baking

Automatic programs

Please refer to the cookbook for information on suitable bakeware.

Follow the instructions on the display.

Convection Bake

Use this operating mode if you are baking on multiple shelf levels at the same time.

You can use any type of bakeware made of heat-resistant material.

Because the blower distributes the heat around the oven compartment straight away, you can use a lower temperature than you would with the Surround operating mode.

Surround

Use this operating mode for cooking traditional recipes. If using an older recipe or cookbook, set the oven temperature 50°F (10°C) lower than that recommended. This will not change the cooking duration.

Only bake on one level. If you are making a tray bake, use shelf level 2.

Intensive

This operating mode is suitable for baking cakes with moist toppings, pizza, quiche, etc.

Place the food on shelf level 1.

Bake

Use this operating mode toward the end of cooking to brown the base of the food.

Browning

Use this operating mode toward the end of cooking to brown the top of food.

This operating mode is suitable for gratins and for browning bakes.

Humidity Plus

Use this operating mode for baking batter and frozen lye mixtures.

Always observe USDA/CFIA food safety guidelines.

Roasting tips

- Never roast frozen meat as it will dry out. Always defrost meat before roasting.
- Remove skin and sinew before roasting.
- Marinate and season the meat to taste.
- If you are cooking several pieces of meat together, select pieces that are similar in size.
- Use the universal tray with the wire rack placed on top of it. The oven compartment stays cleaner and you can then use the meat juices collected to make a gravy or sauce.

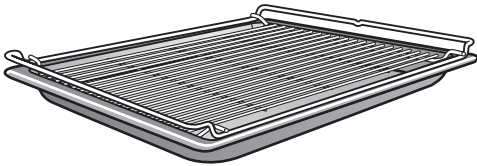

- Allow a resting time of approx. 10 minutes before carving meat. This resting time ensures the meat juices are distributed evenly.

Notes on the operating modes

You can find an overview of all the operating modes with their recommended values in “Main and submenus”.

Combi Steam

This operating mode uses a combination of oven heat and moisture. The addition of steam prevents the surface of the food from drying out. The results are particularly tender and succulent meat with a well-browned outside. Use the Combi Steam  operating mode for cooking meat, fish, and poultry dishes.

You can choose between different types of heating:

- Combi Steam + Convection Bake
- Combi Steam + Surround
- Combi Steam + Maxi Broil

It is recommended to cook meat slowly and gently in several cooking stages: at a high temperature during the first cooking stage to brown the surface. The second cooking stage requires increased moisture and a reduced temperature. The meat cooks evenly and the muscle protein is broken down, making the meat particularly tender.

Tip: Recipes and other information can be found in the Miele App.

Roasting

Automatic programs

Follow the instructions on the display.

Convection Roast

This operating mode is suitable for roasting meat and poultry that needs to be well browned.

Because the blower distributes the heat around the oven compartment straight away, you can use a lower temperature than you would with the Surround operating mode.

Surround

Use this operating mode for cooking traditional recipes. If using an older recipe or cookbook, set the oven temperature 50°F (10°C) lower than that recommended. This will not change the cooking duration.

Use the Bake operating mode towards the end of the cooking duration to brown the base of the food.

Do not use the Intensive operating mode for roasting as the juices will become too dark.

 Danger of injury caused by hot surfaces.

If you open the appliance door when broiling, the controls will get very hot. Keep the door closed during the broiling program.

Always observe USDA/CFIA food safety guidelines.

Broiling tips

- Preheating is not necessary when broiling. Place the food in the cold oven compartment.
- Use the universal tray with the wire rack placed on top of it. Exception: if you are broiling on shelf level 3, insert the universal tray one level down from the wire rack.

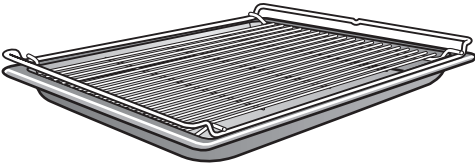

- When broiling fish, place the fish on a piece of parchment paper cut to size.
- Broil thick food, e.g., half a chicken, on shelf level 2 and thin food, e.g., steaks, on shelf level 3.
- Turn the food $\frac{2}{3}$ of the way through the cooking duration. Exception: fish does not need to be turned.

Tips for broiling

- Marinate lean meat or brush it with oil. Do not use other types of fat as they can burn and cause smoke.
- Make diagonal cuts in sausages before broiling.
- It is best to broil food of a similar thickness at the same time so that the broiling time for each item does not vary too greatly.
- To **test the food**, press down on the meat with a spoon. This lets you determine how well the meat has been cooked.
 - **Rare/pink**
If the meat gives easily to the pressure of the spoon, it will still be red on the inside.
 - **Medium**
If there is some resistance, the inside will be pink.
 - **Well-done**
If there is significant resistance, it is cooked through.
- To broil thicker pieces of food more gradually after an initial high temperature, continue broiling at a lower temperature setting or use a lower shelf level to allow the food to cook through to the center.

Broiling

Notes on the operating modes

You can find an overview of all the operating modes with their recommended values in “Main and submenus”.

Combi Steam + Maxi Broil

This operating mode is suitable for broiling food that should be brown on the outside, but not dry, e.g., corn on the cob.

Maxi Broil

Use this operating mode to broil flat thin cuts in large quantities and for browning large baked dishes.

Broil

Use this operating mode to broil flat thin cuts in smaller quantities and for browning small baked dishes.

Convection Broil

This operating mode is suitable for broiling thicker food, such as poultry or rolled meat.

Cleaning and care for the steam oven

Important information on cleaning and care

 Danger of injury caused by hot surfaces.

The steam oven gets hot during operation. You could burn yourself on the heater elements, oven compartment, side racks, or accessories.

Allow the heater elements, oven compartment, side racks, and the accessories to cool before manual cleaning.

 Risk of injury due to electric shock.

The steam from a steam cleaner could reach live electrical components and cause a short circuit.

Do not use a steam cleaner to clean the steam oven.

All surfaces could be discolored or damaged if unsuitable cleaning agents are used. The front of the steam oven is particularly susceptible to damage from oven cleaners and descaling agents.

All surfaces are susceptible to scratching. Scratches on glass can lead to breakage in some circumstances.

Remove any residual cleaning agent immediately.

Stubborn soiling could damage the steam oven in certain circumstances.

Once the oven has cooled, clean the oven cavity, the inside of the door, and the door seal. Waiting too long to clean the oven will make it much more difficult to clean.

Do not use commercial cleaning agents. Only use agents designed for domestic use.

Do not use cleaning agents or liquid dish soap containing aliphatic hydrocarbons as these could cause the seals to swell.

- The appliance and accessories should be cleaned and dried thoroughly after each use.
- Leave the appliance door open until the oven compartment is completely dry.

If the steam oven is not going to be used for a longer period of time, it should be thoroughly cleaned and dried beforehand to prevent the build-up of odors, etc. Leave the door open afterward.

Cleaning and care for the steam oven

Unsuitable cleaning agents

To avoid damaging the surfaces of your appliance, do not use:

- cleaning agents containing soda, ammonia, acids, or chlorides
- cleaning agents containing descaling agents
- abrasive cleaning agents (e.g., powder cleaners and cream cleaners)
- solvent-based cleaning agents
- stainless-steel cleaners
- dishwasher cleaning agents
- cleaning agents for ceramic-glass cooktops
- hard, abrasive brushes or sponges (e.g., pot scourers, brushes, or sponges which have been previously used with abrasive cleaning agents)
- eraser sponges
- sharp metal scrapers
- steel wool
- stainless-steel scouring pads
- spot cleaning with mechanical cleaning agents
- oven cleaners and sprays

Cleaning the steam oven front

- Clean the front of the oven with a soft sponge and a solution of warm water and liquid dish soap.
- After cleaning, wipe the front dry using a soft cloth.

Tip: A clean, damp microfiber cloth without cleaning agent can also be used for cleaning.

Glass cleaners **may be used** to clean the exterior. However **do not** allow them to sit or "puddle", this can cause damage to the surface. **Remove the cleaner promptly.**

Cleaning and care for the steam oven

PerfectClean

The oven compartment, side racks, universal tray, and wire rack surfaces are **treated with PerfectClean**. This finish has an iridescent appearance. PerfectClean surfaces have very good non-stick properties and are easy to clean.

However, it is important to clean the surfaces each time the oven is used. The non-stick properties will deteriorate if soiling is not removed from PerfectClean surfaces after each use. If used frequently without being cleaned, cleaning may become very difficult.

Soiling such as spilt juices and cake mixtures are best removed while the oven compartment is still warm.

Spilt fruit juices may cause discoloration to the surfaces that cannot be removed. However, this does not affect the properties of the PerfectClean finish.

Always remove all cleaning agent residues to protect the non-stick properties.

To protect the non-stick effect of PerfectClean surfaces, please avoid:

- abrasive cleaning agents (e.g., powder cleaners and cream cleaners)
- cleaning agents for ceramic-glass cooktops
- ceramic-glass and stainless-steel cleaners
- steel wool
- abrasive sponges, e.g., pot scourers or sponges which have been previously used with abrasive cleaning agents
- oven sprays
- spot cleaning with mechanical cleaning agents

Do **not** clean PerfectClean accessories in the dishwasher.

Cleaning and care for the steam oven

Oven compartment

The surface of the oven compartment has been treated with PerfectClean.

See “PerfectClean” under “Cleaning and care for the steam oven” for instructions on cleaning.

Ensure that no cleaning agent gets into the openings on the oven compartment rear panel.

To make cleaning the oven compartment easier, you can remove the oven door, dismantle the side racks, and lower the browning/broiling element.

Cleaning after a program using steam

■ Remove:

- condensate using a sponge or absorbent cloth
- light, greasy soiling with a sponge and a solution of liquid dish soap and hot water

■ After cleaning, wipe the surface with clean water to remove any cleaning agent residues.

■ Then dry the oven compartment and the inside of the door with a cloth.

Tip: You can then leave the steam oven to dry automatically (see “Maintenance” under “Cleaning and care for the steam oven”).

Cleaning after a roasting, broiling, or baking program

Clean the oven compartment thoroughly after roasting, broiling, and baking as otherwise soiling can burn on and become impossible to remove.

- Clean the oven compartment and inside of the door with a clean dish sponge, hot water, and a little liquid dish soap. You can use the hard surface of a dish sponge to clean the oven compartment if necessary.
- After cleaning, wipe the surface with clean water to remove any cleaning agent residues.
- Then dry the oven compartment and the inside of the door with a cloth.

Tip: Soaking the soiling for a few minutes with a solution of liquid dish soap and hot water can make cleaning easier. Alternatively, run the [Additional | Maintenance | Soak program](#) (see “Maintenance” under “Cleaning and care for the steam oven”).

Cleaning and care for the steam oven

Cleaning the floor filter

- The filter in the floor of the oven should be cleaned and dried after every use.
- Vinegar can be used to remove discoloration and limescale deposits from the filter in the floor of the oven. Rinse thoroughly with clean water to remove any residual cleaning agent.

Cleaning the door seal

Grease deposits on the door seal can cause it to become brittle and cracked.

Clean the door seal between the inside of the oven door and the oven compartment after every baking or roasting program.

- Clean the door seal using a clean, damp microfiber cloth without any cleaning agent. You can also use a clean sponge and warm water with a little liquid dish soap.
- After cleaning, dry the seal with a soft cloth.
- Replace the seal with a new one if it becomes porous or brittle.

Door seals can be ordered from the Miele Customer Service (see the end of these operating instructions for contact details).

Cleaning the water container and condensate container

The water container and condensate container are suitable for cleaning in a dishwasher.

- Remove the water container and condensate container after every use. Remove the water container and condensate container by pushing them upward slightly.
- Empty the water container and condensate container.

Water can drip into the water container and condensate container compartment when removing the containers.

- Dry the compartment if necessary.
- Rinse the water container and condensate container by hand or in the dishwasher.
- Then dry the water container and condensate container with a soft cloth to prevent limescale.

Cleaning and care for the steam oven

Accessories

Cleaning the universal tray and wire rack

The surfaces of the universal tray and the wire rack have been treated with PerfectClean.

See “PerfectClean” under “Cleaning and care for the steam oven” for instructions on cleaning.

- Remove:
 - light soiling with a soft clean sponge and a mild solution of warm water and liquid dish soap
 - stubborn soiling with a clean dish sponge, hot water, and a little liquid dish soap. If necessary, you can also use the rough side of the sponge.
- After cleaning, wipe the surface with clean water to remove any cleaning agent residues.
- Then dry the surfaces using a cloth.

Cleaning cooking containers

The cooking containers are suitable for cleaning in the dishwasher.

- Wash and dry the cooking containers after each use.
- Vinegar can be used to remove bluish discoloration. Rinse thoroughly with clean water to remove any residual cleaning agent.

Cleaning and care for the steam oven

Cleaning the side racks

The surfaces of the side racks have been treated with PerfectClean.

See “PerfectClean” under “Cleaning and care for the steam oven” for instructions on cleaning.

⚠ Danger of injury caused by hot surfaces.

The steam oven gets hot during operation. You could burn yourself on the heater elements, oven compartment, or accessories.

Allow the heater elements, oven compartment, and accessories to cool before removing the side racks.

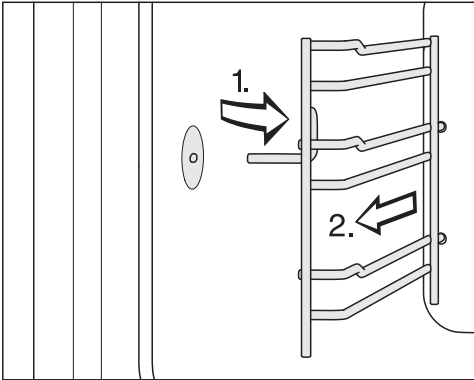

- Pull the side racks out of the holder (1.) and remove them (2.).

- Remove:

- light soiling with a soft clean sponge and a mild solution of warm water and liquid dish soap
- stubborn soiling with a clean dish sponge, hot water, and a little liquid dish soap. If necessary, you can also use the rough side of the sponge.

- After cleaning, wipe the surface with clean water to remove any cleaning agent residues.

- Then dry the side racks with a cloth.

Reinstall by following these instructions in reverse order.

- Reinstall the side racks carefully.

If the side racks are not correctly inserted, there is no anti-tip protection. The temperature sensor could also be damaged when cooking containers are placed in the steam oven.

Cleaning and care for the steam oven

Lowering the browning/broiling element

If the ceiling of the oven is badly soiled, the browning/broiling element can be lowered by approx. 2" (5 cm) to make cleaning easier.

 Danger of injury caused by hot surfaces.

The steam oven gets hot during operation. You could burn yourself on the heater elements, oven compartment, side racks, or accessories.

Allow the heater element, oven compartment, side racks, and the accessories to cool before cleaning.

Take care not to damage the browning/broiling element.

Do not use force when lowering the browning/broiling element.

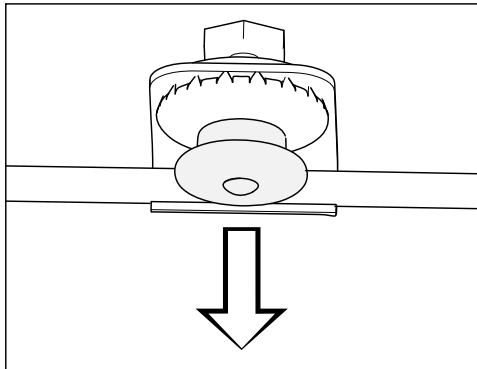

- Carefully pull down the pressure cap. The browning/broiling element then lowers automatically.

- Clean the ceiling of the oven with a damp cloth or a soft sponge (see “Oven compartment” under “Cleaning and care for the steam oven”).
- After cleaning the browning/broiling element, push the pressure cap back up. Make sure the pressure cap engages correctly.

Cleaning and care for the steam oven

Maintenance

The Finish at and Start at functions are not available in maintenance programs.

Soaking

Stubborn soiling can be soaked using this maintenance program.

- Let the oven compartment cool down.
- Remove all accessories from the oven.
- Remove coarse soiling with a cloth.
- Select Additional  | Maintenance | Soak.

The soaking process takes approx. 10 minutes.

Drying

This maintenance program can be used to dry any residual moisture in the oven compartment, including in inaccessible areas.

- Dry the oven compartment with a cloth.
- Select Additional  | Maintenance | Drying.

The drying process takes approx. 20 minutes.

Rinsing

The water-carrying system is rinsed out during this maintenance program. Any remaining food deposits are rinsed away.

- Select Additional  | Maintenance | Rinse.

- Follow the instructions on the display.

The rinsing process takes approx. 10 minutes.

Descaling the steam oven

We recommend using Miele Descaling Tablets (see “Optional accessories”) to descale the appliance. These have been specially developed for use with Miele appliances to optimize the descaling process. Other descaling agents, which contain other acids besides citric acid and/or other undesirable substances, such as chlorides, could cause damage to the product. Moreover, the descaling result required could not be guaranteed if the descaling solution was not of the appropriate concentration.

Do not spill descaling agent onto metal surfaces. This can cause stains to appear.

However, should any descaling agent get onto these surfaces, wipe it away immediately.

The steam oven has to be descaled after a certain number of operating hours. When the time comes to descale it, the number of uses remaining lights up in the display. Only cooking processes that use steam are counted. The steam oven will be disabled after the last remaining cooking process.

We recommend that you descale the appliance before it locks out.

During the descaling process, the water container must be rinsed out and re-filled with fresh water. The condensate container needs to be emptied.

Cleaning and care for the steam oven

- Switch the steam oven on and select **Descal** .

The message **Please wait** will appear in the display. The descaling process is being prepared. This may take a few minutes. As soon as the appliance is ready, you will be prompted to fill the water container.

- Fill the water container with lukewarm water up to the level marker  and drop 2 Miele Descaling Tablets in it.
- Wait until the descaling tablets have dissolved.
- Push the water container into the appliance.
- Confirm with **OK**.
- Empty the condensate container.
- Confirm with **OK**.

The time left appears in the display. The descaling process will now begin.

Do not turn the steam oven off during the descaling process, otherwise the whole process will have to be started from the beginning again.

During the course of the descaling process, the water container needs to be rinsed and filled with fresh water twice. The condensate container needs to be emptied.

- Follow the instructions in the display.
- Confirm each with **OK**.

Once the time left has elapsed, **Steam reduction** and **Ready** will appear in the display. A signal sounds.

- Wait until **Steam reduction** goes out in the display.

The descaling process is complete.

- Select the  sensor button to return to the main menu.
- Remove the water container and condensate container and empty them as required.
- Clean and dry the water container and condensate container.
- Turn the steam oven off.
- Open the door and let the oven cool down.
- Then dry the oven compartment.
- Leave the appliance door open until the oven compartment is completely dry.

Cleaning and care for the steam oven

Removing the door

- Prepare a suitable underlay for the door, such as a soft cloth.
- Open the door slightly.

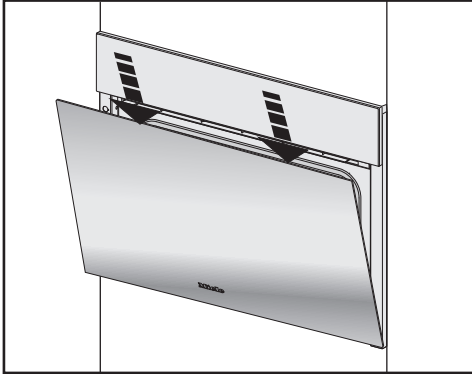

- Using two hands placed on the upper edge of the door, push the door downward briefly.

The oven door is connected to the hinges by retainers. Before removing the door from the retainers, the locking clamps on both hinges have to be released.



- Open the door fully.

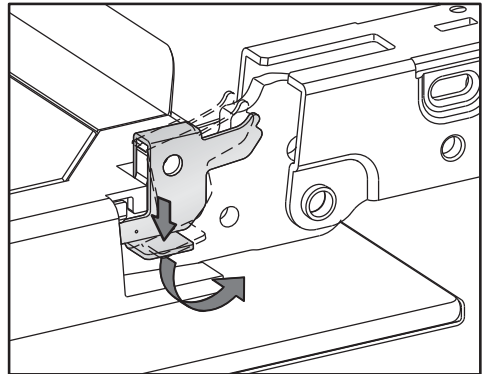

- Release the locking clamps on the hinges by pushing them down as far as they will go until they are at an angle.

The steam oven could become damaged if you remove the door incorrectly.

Never pull the door horizontally off its retainers, as they will spring back against the steam oven.

Do not pull the door off the retainers by the handle, as the handle could break off.

- Raise the door up until it rests partially open.

Cleaning and care for the steam oven

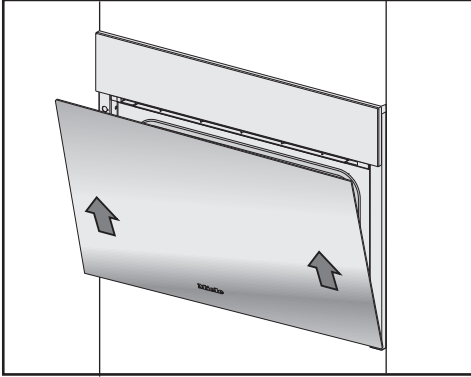

- Hold the door on either side and evenly pull diagonally upward from the hinge retainers. Make sure that the door is straight.
- Lay the door on the previously prepared underlay.

Installing the door

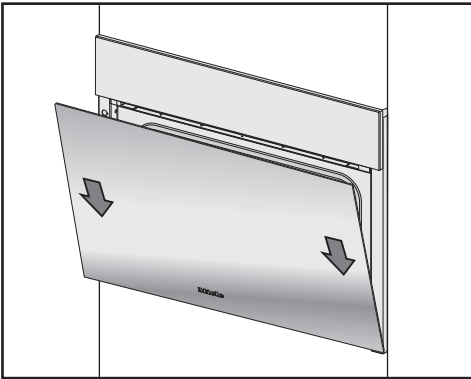

- Hold the door securely on both sides and carefully install it back into the hinge retainers. Make sure that you do not tilt the door.
- Open the door fully.

If the locking clamps are not locked, the door could become loose, resulting in damage.

Ensure that the locking clamps are locked after reinstalling the door.

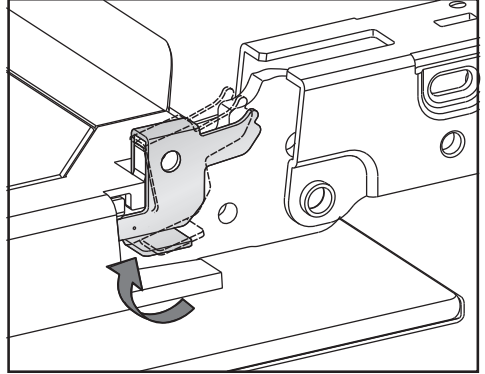

- To relock the locking clamps, turn them back up to the horizontal position as far as they will go on both door hinges.

Frequently Asked Questions

With the help of the following guide minor faults in the performance of the machine, some of which may result from incorrect operation, can be remedied without contacting the Service Department.

This guide may help you to find the reason for the fault, and how to correct it.

Problem	Possible cause and solution
You cannot turn the appliance on.	The circuit breaker has tripped. <ul style="list-style-type: none"> ■ Reset the circuit breaker (see data plate for the correct fuse rating).
	There may be a technical fault. <ul style="list-style-type: none"> ■ Disconnect the steam oven from the power supply for approx. 1 minute by: <ul style="list-style-type: none"> – tripping the relevant circuit breaker or screwing the fuse out completely, or – tripping the ground fault circuit interrupter (GFCI) outlet. ■ If, after turning the circuit breaker or GFCI back on, the steam oven will still not turn on, contact a qualified service technician or Miele Customer Service.
The oven does not heat up.	Demo mode is activated. The steam oven can be operated; however, the heater elements will not work. <ul style="list-style-type: none"> ■ Deactivate demo mode (see “Showroom program” under “Settings”).
	The oven compartment has been heated by a warming drawer operating beneath it. <ul style="list-style-type: none"> ■ Open the door and let the oven cool down.
The fan can still be heard after the appliance has been turned off.	The fan is still running. The appliance is fitted with a fan which removes steam from the oven. The fan will continue to run for a while after the appliance has been switched off. It will turn itself off automatically after a while.

Frequently Asked Questions

Problem	Possible cause and solution
<p>The sensor buttons do not respond.</p>	<p>You have selected the Display QuickTouch Off setting. Therefore, when the steam oven is switched off, the sensor buttons do not respond.</p> <ul style="list-style-type: none"> ■ As soon as the steam oven is turned on, the sensor buttons will respond. If you want the sensor buttons to always respond even when the steam oven is turned off, select the Display QuickTouch On setting.
	<p>The steam oven is not connected to the power supply.</p> <ul style="list-style-type: none"> ■ Check that the electrical plug of the steam oven is correctly inserted into the socket. ■ Check if the breaker has tripped. If it has, contact a qualified electrician or Miele Customer Service.
	<p>There is a fault with the controls.</p> <ul style="list-style-type: none"> ■ Touch and hold the ⏻ On/Off sensor button until the display turns off and the steam oven restarts.
<p>A humming sound can be heard during operation and after turning off the steam oven.</p>	<p>This noise does not indicate incorrect operation or an appliance fault. The noise is made by water being pumped through the system.</p>
<p>After moving house, the steam oven no longer switches from the heating-up phase to the cooking phase.</p>	<p>The boiling temperature of the water has changed as the altitude of the new location for the appliance differs from the old one by at least 984 ft (300 m).</p> <ul style="list-style-type: none"> ■ To adjust the boiling temperature, you need to descale the appliance (see “Maintenance” under “Cleaning and care for the steam oven”).
<p>During operation, an unusually large amount of steam escapes or steam escapes from parts of the steam oven where it does not usually.</p>	<p>The door is not properly closed.</p> <ul style="list-style-type: none"> ■ Close the door.
	<p>The door seal is not correctly fitted.</p> <ul style="list-style-type: none"> ■ If necessary, press it in all the way round the door to make sure it is fitted evenly.
	<p>The door seal is damaged, e.g. cracked.</p> <ul style="list-style-type: none"> ■ Replace the door seal. This can be ordered from Miele Service (see the end of this booklet for contact details).

Frequently Asked Questions

Problem	Possible cause and solution
<p>The oven lighting does not come on.</p>	<p>The bulb needs to be replaced.</p> <ul style="list-style-type: none"> ■ Contact Miele Service to have the bulb replaced.
<p>The control panel will not open or close automatically despite tapping the  sensor button several times.</p>	<p>There is an obstruction in the control panel.</p> <ul style="list-style-type: none"> ■ Remove the obstruction. <p>The obstruction sensor is very sensitive, which means the control panel sometimes does not open or close.</p> <ul style="list-style-type: none"> ■ Open/close the control panel manually (see end of this section) ■ If the problem occurs again, contact Miele Service.
<p>The <i>Start at</i> and <i>Finish at</i> functions are not available.</p>	<p>The temperature in the oven compartment is too high, e.g., after a program has finished.</p> <ul style="list-style-type: none"> ■ Open the door and let the oven cool down. <p>These functions are not generally available in maintenance programs.</p>
<p>Cakes, cookies, and pastries are not cooked properly after following the durations given in the recipe.</p>	<p>The set temperature is not consistent with the one given in the recipe.</p> <ul style="list-style-type: none"> ■ Change the temperature. <p>The recipe has been altered. For example, adding more liquid or eggs can increase the cooking duration required.</p> <ul style="list-style-type: none"> ■ Adapt the temperature and/or cooking duration to the altered recipe.
<p>Cakes, cookies, or pastries are unevenly browned.</p>	<p>The temperature was set too high.</p> <p>More than two shelf levels were used for baking.</p> <ul style="list-style-type: none"> ■ Bake on a maximum of two levels.
<p>F10</p>	<p>The suction hose in the water container is</p> <ul style="list-style-type: none"> – is not inserted correctly. – is not positioned vertically. <ul style="list-style-type: none"> ■ Connect it properly and make sure it is vertical: <div data-bbox="639 1302 824 1453" data-label="Image"> <p>The diagram shows a top-down view of a rectangular water container. A suction hose is shown being inserted into a circular opening on the right side. The hose is positioned vertically, with its end resting on the bottom surface of the container. A small rectangular component is visible inside the container, near the hose's insertion point.</p> </div>

Frequently Asked Questions

Problem	Possible cause and solution
F11 F20	<p>The drain hoses are blocked.</p> <ul style="list-style-type: none"> ■ Descal the steam oven (see “Maintenance” under “Cleaning and care for the steam oven”). ■ If the fault message appears again, contact Miele Customer Service.
F44	<p>Communication fault</p> <ul style="list-style-type: none"> ■ Turn the steam oven off and then back on again after a few minutes. ■ If the same message appears again, contact Miele Service.
F55	<p>The maximum length of time for which the combi steam oven can be operated on a function has been exceeded, so the appliance has switched itself off automatically for safety reasons.</p> <ul style="list-style-type: none"> ■ Switch the steam oven off and then back on again. <p>The steam oven is immediately ready for use again.</p>
F196	<p>There is a fault.</p> <ul style="list-style-type: none"> ■ Turn the steam oven off and then back on again.
	<p>The drain filter is not inserted correctly.</p> <ul style="list-style-type: none"> ■ Turn the steam oven off. <div style="text-align: center;">  </div> <ul style="list-style-type: none"> ■ Insert the filter correctly: ■ Turn the steam oven back on again. ■ If the same message appears again, contact Miele Customer Service.
F and other fault codes	<p>Technical fault</p> <ul style="list-style-type: none"> ■ Turn the appliance off and contact Miele.

Frequently Asked Questions

Opening the control panel manually

- Carefully open the door.

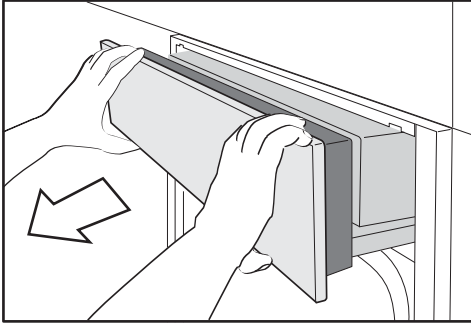

- Hold the control panel at the top and bottom.
- Pull out the panel towards you.
- Carefully push it upwards.

Closing the control panel manually

- Hold the control panel at the top and bottom.
- Carefully push it downwards.

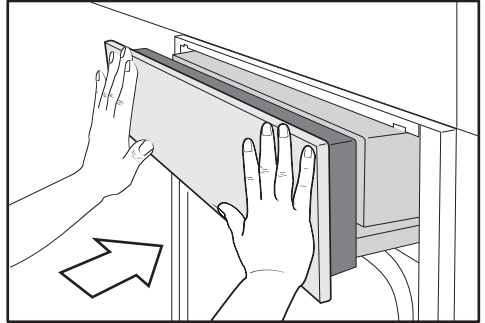

- Push the panel right in.

Optional accessories

Miele offers a range of useful accessories, as well as cleaning and conditioning products for your appliance.

These products can be easily ordered from the Miele webshop.

These products can also be ordered from Miele Technical Service (see the end of these operating instructions) or your Miele dealer.

Containers

Miele offers a wide range of cooking containers. These have all been optimized for Miele appliances in terms of functionality and dimensions. Detailed information on each of our products can be found on the Miele website.

- Perforated cooking containers in various sizes
- Solid cooking containers in various sizes
- Gourmet Casserole Dishes in various sizes
- Lid for Gourmet Casserole Dish

Other

- Baking trays
- Round baking pan
- FlexiClip telescopic runners
- Holding rack for cooking containers with a width of 12 13/16" (325 mm)

Cleaning and care products

- DGClean
Special cleaning agent for removing stubborn soiling from the oven compartment, particularly after roasting
- Descaling tablets (6)

Contact in the event of a fault

In the event of a fault which you cannot remedy yourself, please contact your Miele dealer or Miele Customer Service.

You can book a Miele Service Call online at www.miele.com/service.

Contact information for Miele Customer Service can be found at the end of this document.

Please quote the model identifier and serial number of your appliance (SN) when contacting Miele Customer Service. Both pieces of information can be found on the data plate.

The data plate can be found at the top on the opened control panel.

Appliance warranty and product registration

You can register your product and/or view the manufacturer's warranty terms and conditions for Miele appliances and vacuum cleaners at www.mieleusa.com.

Caring for the environment

Disposal of the packing material

The cardboard box and packing materials protect the appliance during shipping. They have been designed to be biodegradable and recyclable.

Ensure that any plastic wrappings, bags, etc. are disposed of safely and kept out of the reach of children. Danger of suffocation!

Disposal of your old appliance

Electrical and electronic appliances contain valuable materials. They also contain certain substances, compounds and components which were essential for the proper functioning and safe use of the equipment. Handling these materials improperly by disposing of them in your household waste can be harmful to your health and the environment. Therefore, please do not dispose of your old appliance with regular household waste and follow local regulations on proper disposal.



Consult with local authorities, dealers or Miele in order to dispose of and recycle electrical and electronic appliances. Miele assumes no responsibility for deleting any personal data left on the appliance being disposed. Please ensure that your old appliance is kept away from children until removal. Observe safety requirements for appliances that may tip over or pose an entrapment hazard.

IMPORTANT SAFETY INSTRUCTIONS - INSTALLATION



Risk of damage caused by incorrect installation.

Incorrect installation can cause damage to the steam oven.

The steam oven must only be installed by a qualified specialist.

- ▶ The connection data (frequency and voltage) on the steam oven's data plate must correspond with those of the electricity supply in order to ensure that no damage can occur to the steam oven. Compare this data before connecting the appliance. If in any doubt, consult a qualified service technician.
- ▶ Power bars and extension cords do not guarantee the required safety of the appliance (risk of fire). Do not use them to connect the steam oven to the power supply.
- ▶ The socket should be easily accessible after the steam oven has been installed.
- ▶ The steam oven must be positioned so that you can see the contents of a cooking container placed on the top shelf level. Otherwise there is a risk of injuries or spillages of hot food.

Note to the installer:

Please leave these instructions with the consumer of the appliance for the local building inspectors use.

Installation

Installation dimensions DGC 7440

Installation in a tall cabinet

Observe the required minimum installation height of 36" (914 mm).

Miele Steam Ovens can be installed flush or proud. Discuss your requirements with your architect, kitchen designer, and installer.

More installation drawings are available on the Miele website.

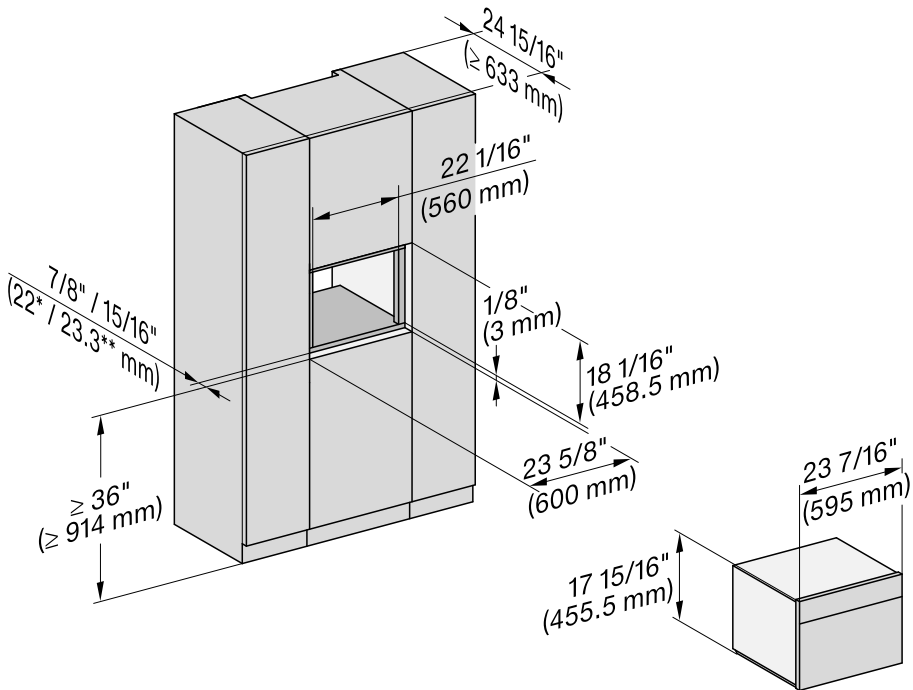

* Steam ovens with glass front

** Steam ovens with metal front

Side view

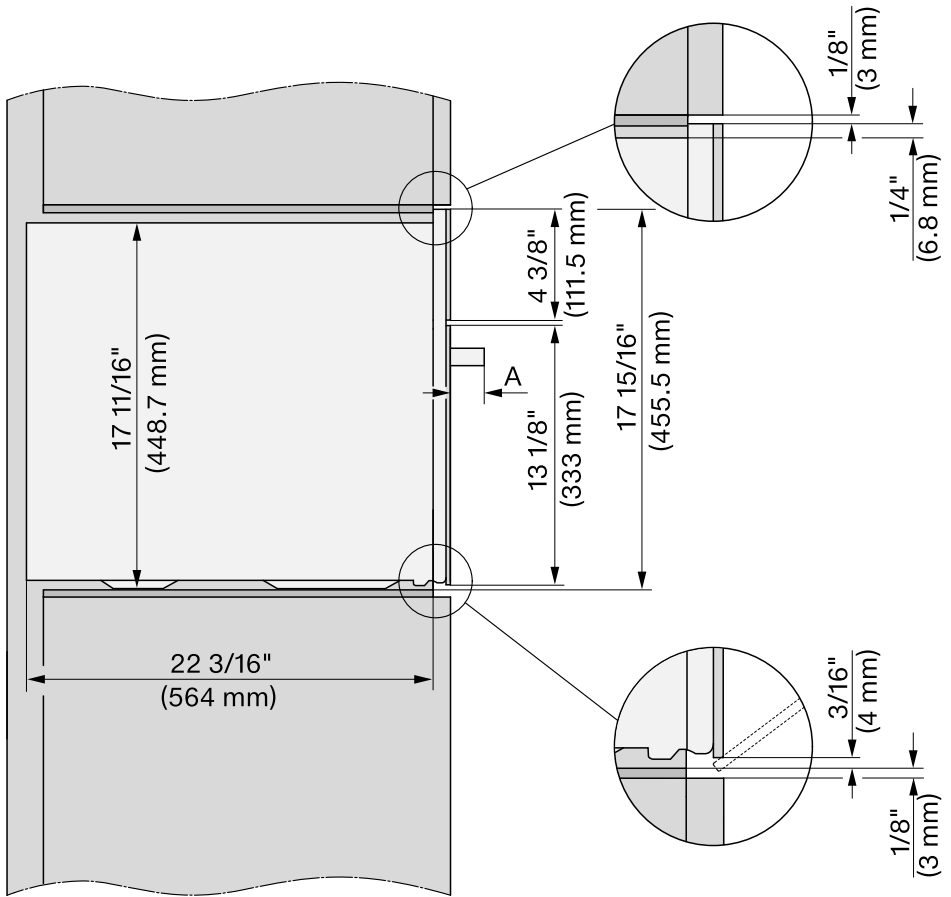

A DGC 74xx: $1 \frac{7}{8}$ " (47 mm)

Installation

Swivel range for control panel

The area in front of the control panel must not be blocked by anything (such as a door handle) that would hinder it from opening and closing.

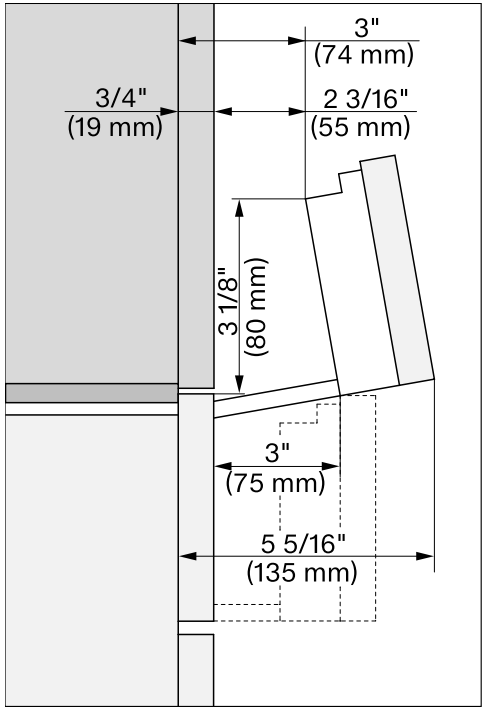

Connections and ventilation

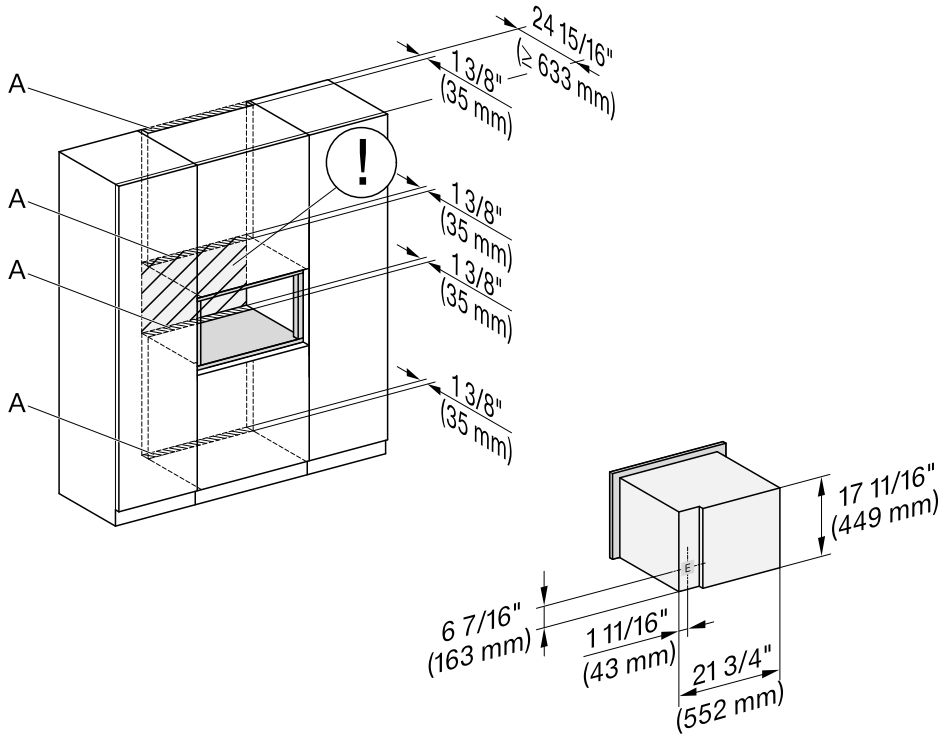

A Cutout (min. $2 \frac{3}{4} \text{ in.}^2$ or 1800 mm^2) for power cord and ventilation

ⓘ No electrical connection in this area. The socket for the electrical connection must be accessible, e.g., in an adjacent kitchen cabinet.

E Electrical connection

Installation

Installation dimensions DGC 7370, DGC 7470

Installation in a tall cabinet

Observe the required minimum installation height of 36" (914 mm).

Miele Steam Ovens can be installed flush or proud. Discuss your requirements with your architect, kitchen designer, and installer.

More installation drawings are available on the Miele website.

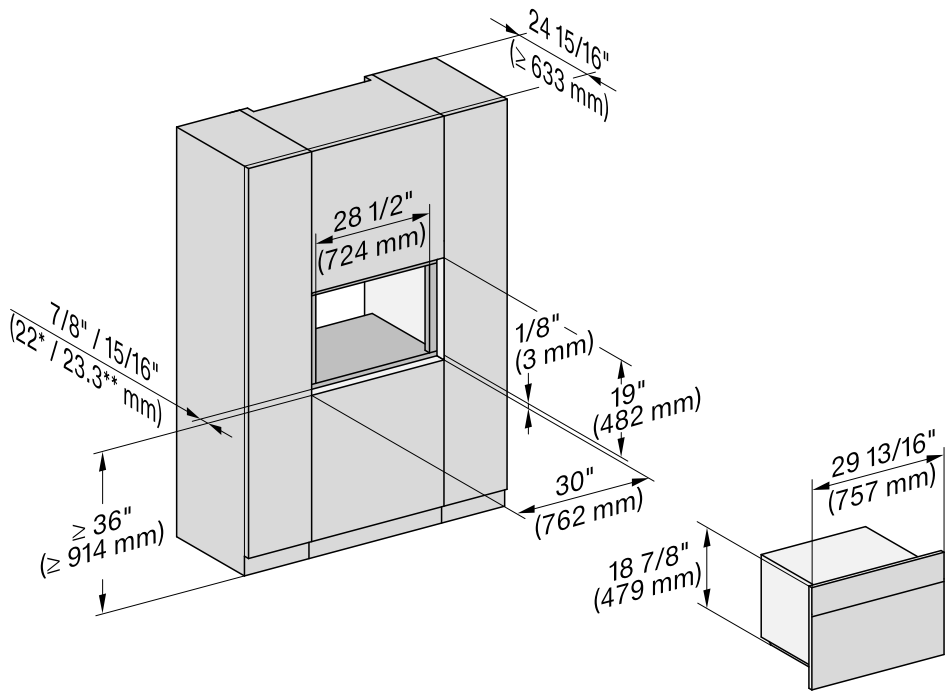

* Steam ovens with glass front

** Steam ovens with metal front

Side view

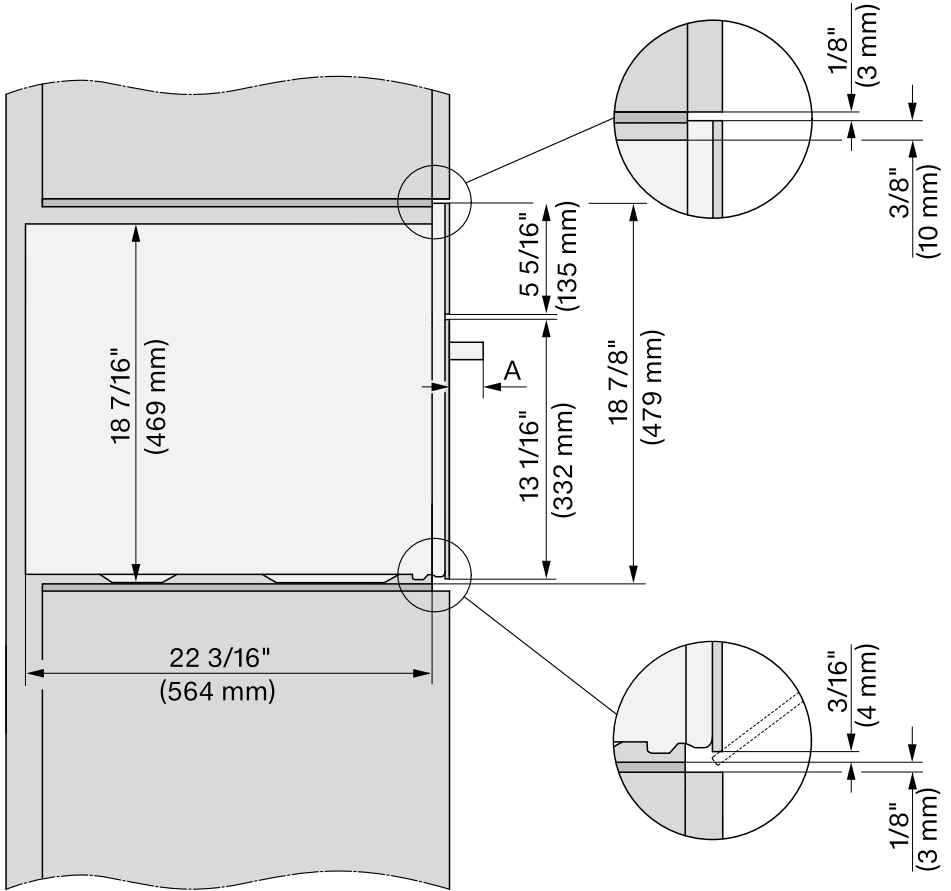

- A** DGC 73xx: $2\frac{1}{2}$ " (64 mm)
DGC 74xx: $1\frac{7}{8}$ " (47 mm)

Installation

Swivel range for control panel

The area in front of the control panel must not be blocked by anything (such as a door handle) that would hinder it from opening and closing.

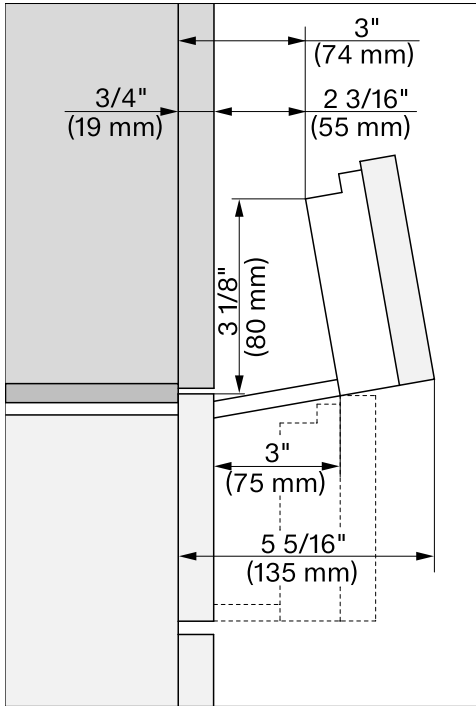

Connections and ventilation

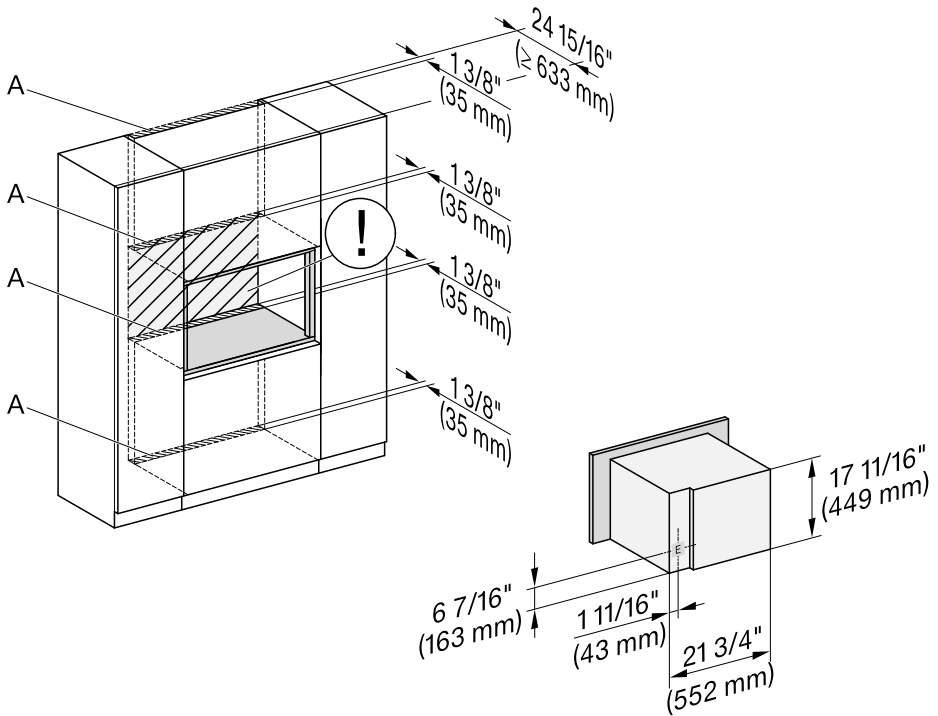

A Cutout (min. $2 \frac{3}{4} \text{ in.}^2$ or 1800 mm^2) for power cord and ventilation

ⓘ No electrical connection in this area. The socket for the electrical connection must be accessible, e.g., in an adjacent kitchen cabinet.

E Electrical connection

Installation

Installing and removing the steam oven

For safety reasons, the steam oven may only be used when it has been fully installed.

Do not open the door when the steam oven is on the floor. This could damage the door.

Do not open the door until the steam oven has been installed inside the housing unit.

Maintain the required minimum installation height of 36" (914 mm).

It is vital to observe the connection data in "Electrical connection" under "Installation".

Securing the steam oven in the housing unit

Risk of damage from incorrect transportation.

Lifting the steam oven by the door handle could cause damage to the door.

Use the recessed grips on each side of the housing to carry the appliance.

The steam generator may malfunction if the steam oven is not on a level surface.

The maximum deviation from the horizontal that can be tolerated is 2°.

- Push the steam oven into the housing unit and align it in the center of the housing unit. When doing so, make sure that the power cord does not get trapped or damaged.
- Open the door.

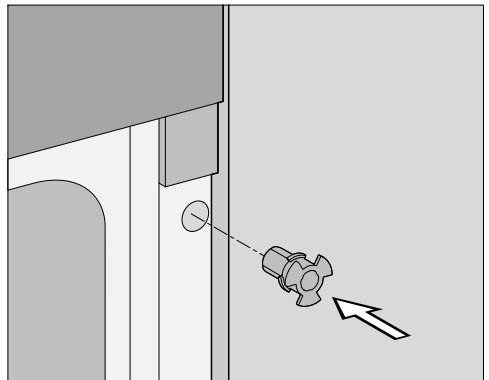
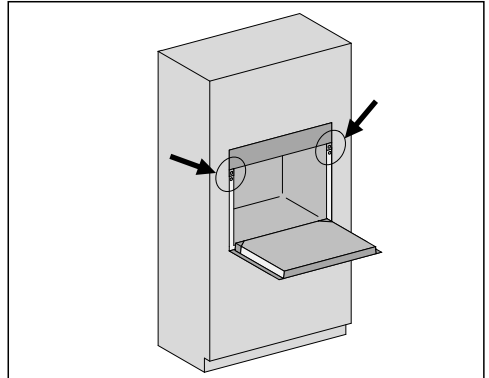

- Insert the mounting aid into the hole in the front frame.

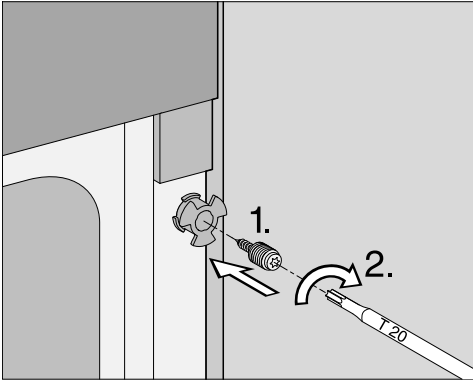

- Insert the bolt into the mounting aid and tighten it in the housing unit.



- Screw the knurled nut onto the bolt by hand to fix the steam oven in the housing unit.

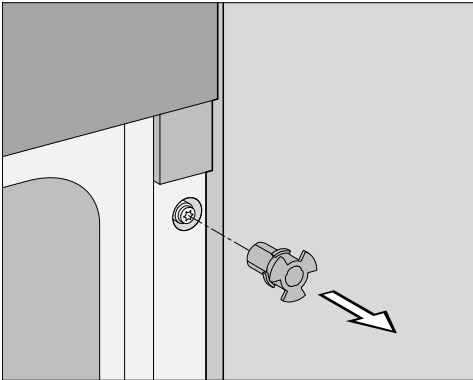

- Remove the mounting aid.

The door may be damaged if the knurled nuts protrude from the front frame.
Make sure that the knurled nuts are flush with the front frame after installation.

- Connect the appliance to the power supply.
- Check all functions of the steam oven are working correctly in accordance with the operating instructions.

Installation

Taking the steam oven out of the housing unit

- Open the door.
- Unscrew the knurled nuts and bolts from the front frame (see “Securing the steam oven in the housing unit”). Keep these parts in case the oven needs to be installed again in the future.
- Pull the steam oven out of the housing unit.

Risk of damage from incorrect transportation.

Lifting the steam oven by the door handle could cause damage to the door.

Use the recessed grips on each side of the housing to carry the appliance.

- Take the steam oven out of the housing unit.
- Disconnect the steam oven from the power supply.

Electrical connection

 Risk of injury due to electric shock.

During installation, maintenance, and repair work, the steam oven must be disconnected from the electricity supply:

To disconnect the steam oven, fully unscrew the breakers, trip the ground fault circuit interrupter, or unplug the power cord from the socket. To do this, pull the plug, not the power cord.

 Risk of injury.

Installation, repairs, and other work by unqualified persons could be dangerous. Miele cannot be held liable for unauthorized work.

Installation, maintenance, and repairs must only be carried out by a technician authorized by Miele.

The connection data (frequency and voltage) on the steam oven's data plate must correspond with those of the electricity supply in order to ensure that no damage can occur to the steam oven.

Compare this data before connecting the appliance. If in any doubt, consult a qualified service technician.

For safety reasons, the steam oven may only be used after it has been built in.

Installer:

- Please leave these instructions with the customer.

Connection

- Make sure that the connection data on the data plate (voltage, frequency, and fuse rating) matches that of your electricity supply.

The data plate is located on the top of the housing.

Connection data

The steam oven is equipped with a 78 3/4" (2.0 m) power cord with plug or connection to an electricity supply with:
208/240 V/20 A/60 Hz

Ensure that the socket is easily accessible after the steam oven has been installed.

Replacing the power cord

If the power cord needs to be replaced, it must be replaced with a type H 05 VV-F cord with a suitable cross section, available from Miele.

Declaration of conformity

Frequency band	2,412 GHz – 2,462 GHz
----------------	--------------------------

Maximum transmitting power	< 100 mW
----------------------------	----------

**Please have the model and serial number
of your appliance available when
contacting Customer Service.**

U.S.A.

Miele, Inc.

National Headquarters

9 Independence Way
Princeton, NJ 08540
www.mieleusa.com

Customer Support

Phone: 888-99-MIELE (64353)
info@mieleusa.com

International Headquarters

Miele & Cie. KG
Carl-Miele-Straße 29
33332 Gütersloh
Germany

Canada

**Importer
Miele Limited**

Headquarters and Miele Centre

161 Four Valley Drive
Vaughan, ON L4K 4V8
www.miele.ca

Customer Care Centre

Phone: 800-565-6435
905-532-2272
customercare@miele.ca

DGC 7440, DGC 7370, DGC 7470

en-US, CA

M.-Nr. 11 923 940 / 00