

Operating and Installation Instructions

Rangetops

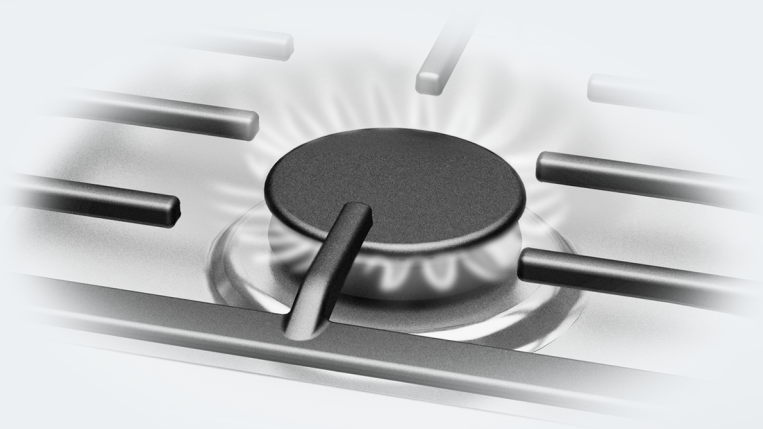

To prevent accidents and damage to the range, you **must** read all instructions supplied before installing or using the appliance.

IMPORTANT SAFETY INSTRUCTIONS

⚠ WARNING: If the information in this manual is not followed exactly, a fire or explosion may result causing property damage, personal injury, or death.

- Do not use or store gasoline or other combustible liquids or vapors in the vicinity of this or any other appliance.
- WHAT TO DO IF YOU SMELL GAS
 - Do not try to light any appliance.
 - Do not touch any electric switches.
 - Do not use any phones inside your building.
 - Immediately call your gas supplier from a neighbor's phone. Follow the gas supplier's instructions.
 - If you are unable to reach your gas provider, call the fire department.
- Installation and service must be performed by a qualified installer, qualified service agency or your gas provider.
(In Massachusetts, installation must be performed by a licensed installer / gas fitter.)
- Note to the installer:
Please give these installation instructions to the consumer for the local electrical/gas inspector.



IMPORTANT SAFETY INSTRUCTIONS	2
IMPORTANT SAFETY INSTRUCTIONS	5
Guide to the Rangetop	16
KMR 1124.....	16
KMR 1134-1	17
KMR 1135-1	18
KMR 1136-1	19
KMR 1354-1	20
KMR 1355-1	21
KMR 1356-1	22
Operation tips	23
Automatic re-ignition	23
Before first use	24
Cleaning the rangetop for the first time.....	24
Seasoning the griddle plate.....	24
Operation of the burners	25
Turning on.....	25
Adjusting the flame.....	26
Visual characteristics gas flames	26
Turning off.....	26
Cookware	27
Energy saving tips	28
Operation of the grill	29
Assembling the grill	29
Turning on the grill	30
Tips for grilling	30
Operation of the griddle	31
Turning on the griddle.....	31
Settings	32
Tips for frying	32
Cleaning and care	33
Rangetop.....	34
Dishwasher-safe grates.....	34
Burner control knobs with stainless steel finish	34
Simmer burner / Power burners	34
Cleaning the dishwasher-safe grilling grate	35

Contents

Cleaning the griddle plate	35
Frequently Asked Questions	36
Notes on installation	38
Distance to the range hood.....	38
RBGDF Backguard.....	38
Weights.....	39
Dimensional drawings	40
Range tops KMR 1124, KMR 113x-1, KMR 135x-1.....	41
Electrical connection	46
Gas connection	47
Burner ratings	49
Burner ratings KMR 1124.....	49
Burner ratings KMR 1134-1	50
Burner ratings KMR 1135-1	51
Burner ratings KMR 1136-1	52
Burner ratings KMR 1354-1	53
Burner ratings KMR 1355-1	54
Burner ratings KMR 1356-1	55
Technical Service	56
Contact in case of fault	56
Warranty	56
Data plate	56
MieleCare	57
Caring for the environment	58

IMPORTANT SAFETY INSTRUCTIONS

When using the appliance, follow basic safety precautions, including the following:

Read all instructions before installation and use of the rangetop to prevent accidents and machine damage.

This appliance conforms to current safety requirements. Inappropriate use can, however, lead to personal injury and damage to property.

To avoid the risk of accidents and damage to the appliance, please read these instructions carefully before installing or using it for the first time. They contain important notes on installation, safety, use and maintenance.

Miele cannot be held responsible for damage caused by the non-observance of these instructions.

Keep these instructions in a safe place and pass them on to any future owner.

IMPORTANT SAFETY INSTRUCTIONS

Appropriate use

- ▶ This rangetop is intended for residential use and use in other similar environments.
- ▶ This appliance is not intended for outdoor use.
- ▶ The rangetop is intended for residential use only to prepare food and keep it warm. Any other use occurs at the owner's own risk and may be dangerous.
- ▶ Persons who are unable to safely operate the range due to limited physical, sensory or mental capabilities, or because of a lack of experience or knowledge, may only use the appliance if they are supervised while doing so. These persons may only use the appliance without supervision if they have been shown how to use it in a safe manner, and if they are able to recognize and understand the potential risks of improper use.

IMPORTANT SAFETY INSTRUCTIONS

Safety with children

- ▶ Do not leave children unattended: Children should not be alone or unsupervised in the area where the rangetop is installed. Do not allow them to sit or stand on the appliance.
- ▶ All children must be kept away from the rangetop.
- ▶ Please supervise any children in the vicinity of the rangetop and do not let them play with the appliance.
- ▶ The rangetop gets hot when in use and remains hot for some time after being turned off. Keep children away from the appliance until it has cooled down and is no longer a burn hazard.
- ▶ Danger of suffocation! Ensure that any plastic wrappings, bags, etc. are disposed of safely and kept out of the reach of children.
- ▶ Burn hazard!
Keep the spaces above and behind the rangetop clear of any items that could draw the attention of children. Otherwise, they can be tempted into climbing onto the appliance.
- ▶ Risk of burning or scalding.
Turn pot and pan handles inward, so children cannot pull them down and be burned.

IMPORTANT SAFETY INSTRUCTIONS

Technical safety

- ▶ Failure to observe the information contained in the installation instructions can lead to serious or fatal injuries for children and adults.
- ▶ Unauthorized installation, maintenance, and repairs can cause considerable danger for the user. Installation, maintenance, and repairs must only be carried out by a Miele authorized technician.
- ▶ Maintenance by the user: Never repair or replace any part of the appliance unless the instructions specifically recommend doing so. Service work may only be performed by a qualified technician.
- ▶ A damaged rangetop can be dangerous. Always check for visible signs of damage. Never use a damaged appliance.
- ▶ Reliable and safe operation of the rangetop can only be guaranteed if it is connected to the public power supply.
- ▶ The electrical safety of the rangetop can only be guaranteed when it is properly grounded. Compliance with this essential safety requirement is absolutely mandatory. If in any doubt, please have the building's wiring system inspected by a qualified electrician.
- ▶ Proper installation: Make sure that your appliance has been installed correctly and that it has been grounded by a qualified technician.
- ▶ Do not operate the appliance until it has been properly installed.
- ▶ To avoid damaging the rangetop, make sure that the information (voltage and frequency) on the data plate correspond to the building's power supply before connecting the appliance. When in doubt, consult a qualified electrician.
- ▶ Installation and maintenance of the gas connection must be performed by qualified installers, service agencies or gas providers.
- ▶ Do not use a power strip or extension cord to connect the rangetop to electricity (risk of fire).

IMPORTANT SAFETY INSTRUCTIONS

- ▶ This appliance must not be installed and operated in non-stationary locations (e.g., on a ship).
- ▶ Any contact with live connections or tampering with the electrical or mechanical components of the rangetop will endanger your safety and may lead to appliance malfunctions.
Do not open the appliance housing under any circumstances.
- ▶ Any repairs not performed by a Miele authorized service technician will void the warranty.
- ▶ Defective components should be replaced by Miele original parts only. Only with these parts can the manufacturer guarantee the safety of the appliance.
- ▶ During installation, maintenance, and repair work, the rangetop must be completely disconnected from the household electricity supply. The gas supply must be shut off. Ensure that this is the case by:
 - removing the fuse,
 - “tripping” the circuit breaker, or
 - unplugging the unit. Pull the plug not the cord.
 - Shut off the gas supply and disconnect the rangetop from the gas supply. Installation and maintenance of the gas connection must be performed by qualified installers, service agencies or gas providers.
- ▶ Risk of electric shock!
If the rangetop is defective, immediately turn the appliance off and discontinue use. Disconnect the range from the gas and power supply and call Miele Service.
- ▶ If the rangetop is installed behind a cabinet door, do not close the door while the range is in operation. Heat and moisture can build up behind the closed door and cause damage to the range, cabinetry, and flooring. Do not close the door until the range has completely cooled down.

IMPORTANT SAFETY INSTRUCTIONS

► Reaching over a hot stovetop to access the cabinets can result in burns. You can reduce the risk of burns by installing a range hood that extends at least $4\frac{3}{4}$ " (12 cm) past the bottom of the cabinets.

IMPORTANT SAFETY INSTRUCTIONS

Correct use

- ▶ Do not leave the rangetop unattended when cooking on high power. Spilled food will begin to smoke and cause grease splatter, which can ignite on the range.
- ▶ Oil and fat can catch fire if overheated. Never leave the appliance unattended when cooking with oil and fat. If the oil or fat catches fire, do not attempt to put the flames out with water. Turn off the rangetop and smother the flames using a lid or a suitable fire blanket.
- ▶ Smother the fire or flames, or use a dry chemical extinguishing agent or foam fire extinguisher.
- ▶ Storage in or on the appliance: Flammable materials should not be stored in an oven or in the vicinity of the rangetop.
- ▶ The flames could set the grease filters of a ventilation hood on fire. Do not flambé under a ventilation hood.
- ▶ Never heat empty cookware.
- ▶ Do not heat up food in closed containers, as pressure will build up in the container, causing them to explode. Do not use the rangetop to boil or heat up cans.
- ▶ If the rangetop is covered, there is a risk that the material of the cover will ignite, explode or if the range is still hot or if turned on inadvertently. Never cover the range with a board, cloth, or protective sheet.
- ▶ When using an electrical appliance, e.g., a hand mixer, near the rangetop, make sure that the power cable does not come into contact with the hot range. The cable's insulation could become damaged.
- ▶ Cookware made of plastic or aluminum foil will melt at high temperatures. Do not use any plastic or aluminum foil cookware.

IMPORTANT SAFETY INSTRUCTIONS

- ▶ The rangetop gets hot when in use and remains hot for some time after being turned off. Do not touch the appliance if there is a possibility that it could still be hot.
- ▶ You can burn yourself on a hot rangetop. When cooking on the appliance, protect your hands by using heat-resistant pot holders or oven mitts. Only use dry pot holders or gloves. Wet or damp textiles conduct heat more effectively and produce steam, which poses a burn hazard. Be sure to keep all textiles away from the gas flames. Do not use oversized cloths, dish towels or other similar materials.
- ▶ If the rangetop is accidentally turned on or is still hot, metal objects on the appliance can heat up. Other items may melt or catch fire. Do not place unused items on the range for storage!
- ▶ A range hood installed above the range can become damaged or catch fire as a result of intense heat. Do not use the gas burners without cookware.
- ▶ The high temperatures radiated could cause objects near the rangetop to catch fire.
Do not use the range to heat the room.
- ▶ Only light the gas burners after all burner parts have been properly assembled.
- ▶ If the cookware is too small, it will not sit properly on the burner. If the cookware is too large, heat emitted from the bottom of the cookware may damage the counter, walls with poor heat resistance (e.g., paneled walls), or portions of the rangetop.
- ▶ Make sure that the burner flames do not extend beyond the bottom of the cookware and rise up its sides.
- ▶ Only use cookware with a thick enough bottom. Failure to do so may result in damage to the rangetop.
- ▶ Always use the burner grates supplied with the cooktop. Never place cookware directly on the burner.

IMPORTANT SAFETY INSTRUCTIONS

- ▶ Install the burner grates in an upright position to avoid scratching the cooktop.
- ▶ Remove all grease splatters and other flammable (food) residues on the rangetop. They are a fire hazard.
- ▶ Do not use pots or pans that are large enough to cover several burners. The resulting heat buildup can damage the appliance.
- ▶ If the rangetop has not been used for a long period of time, be sure to thoroughly clean it and have it inspected by an authorized technician before using it again.
- ▶ The use of the rangetop creates heat, moisture and combustion products in the room where it is installed. Make sure that the appliance is installed in location with sufficient ventilation. Natural ventilation openings should not be blocked. Alternatively, a mechanical ventilation device (e.g. a range hood) can be installed.
- ▶ Prolonged intensive use of the appliance may require additional ventilation of the room, e.g., by opening a window, or by turning the range hood to a higher setting.
- ▶ Ask your installer to show you the location of your gas shutoff valve and fuses or circuit breaker panel in your apartment or home. Be sure that you know how and where to disconnect the gas and power supply to your rangetop.
- ▶ Ensure that the igniters are clean and dry to allow the burners to ignite and burn properly.
- ▶ Fire hazard! Loose-fitting or hanging garments can catch fire. Be sure to wear appropriately fitting clothing when cooking. Never allow loose clothing or flammable materials to come into contact with the burners while the burners are in use.
- ▶ When you have finished cooking, make sure that the burners are turned off by checking the position of the knobs.

IMPORTANT SAFETY INSTRUCTIONS

- ▶ The grates, burner cap, bottom parts of the burner, and any other parts located near the burner flame, can still be very hot after cooking and cause burns. Do not touch these components when using the rangetop.
- ▶ Wind can blow curtains over the rangetop, causing them to catch fire. If the range is installed near a window, do not use long curtains.
- ▶ Only certain types of glass, ceramic or other enamel cookware can be used on a gas rangetop without breaking as a result of sudden temperature changes.
- ▶ Do not use cooking utensils on the grill.
- ▶ Wet sponges or clothes can cause burns due to hot steam if they are used to wipe spilled food off a hot burner. Some cleansers can emit hazardous vapors if they are applied to a hot surface. Be careful when cleaning the cooktop.

IMPORTANT SAFETY INSTRUCTIONS

Cleaning and maintenance

- ▶ Do not use a steam cleaner to clean this appliance. Steam could penetrate electrical components and cause a short circuit.

SAVE THESE INSTRUCTIONS AND REVIEW THEM PERIODICALLY

Guide to the Rangetop

KMR 1124

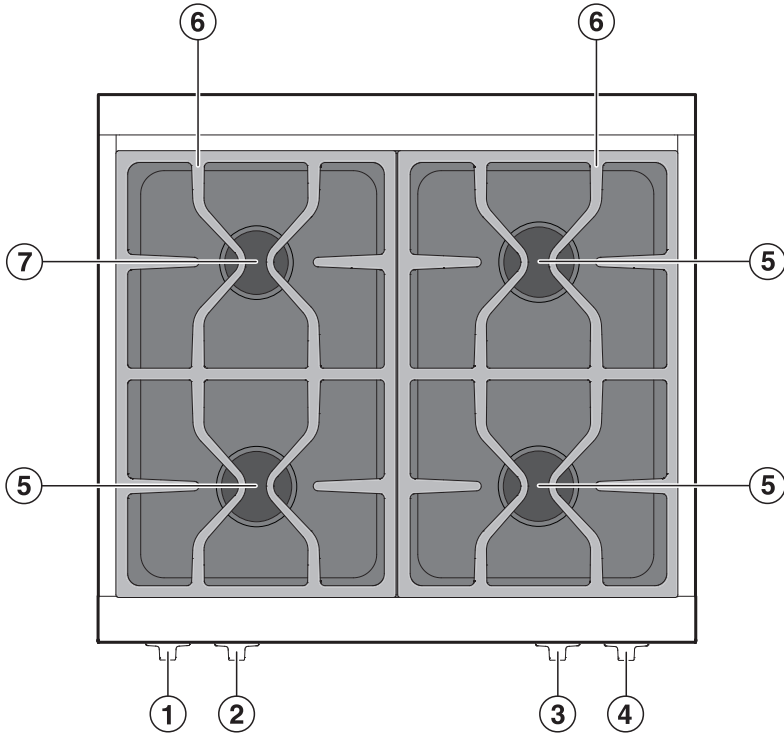

- ① Burner control knob for rear left burner
- ② Burner control knob for front left burner
- ③ Burner control knob for front right burner
- ④ Burner control knob for rear right burner
- ⑤ Power burner
- ⑥ Grates
- ⑦ Simmer burner

KMR 1134-1

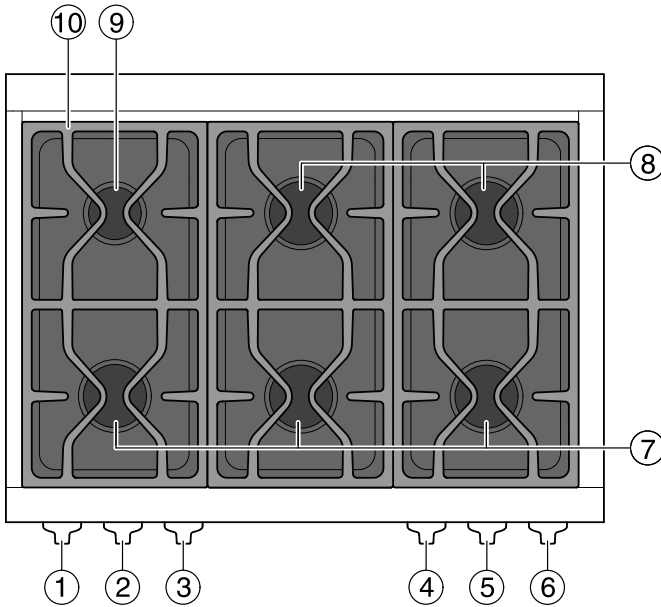

- ① Burner control knob for rear left burner
- ② Burner control knob for front left burner
- ③ Burner control knob for front center burner
- ④ Burner control knob for rear center burner
- ⑤ Burner control knob for front right burner
- ⑥ Burner control knob for rear right burner
- ⑦ Power burner, front
- ⑧ Power burner, rear
- ⑨ Simmer burner
- ⑩ Grates

Guide to the Rangetop

KMR 1135-1

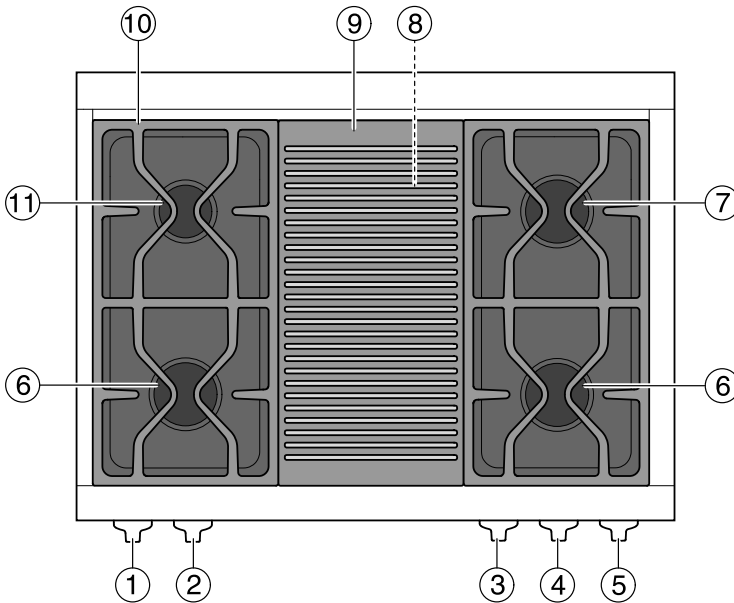

- ① Burner control knob for rear left burner
- ② Burner control knob for front left burner
- ③ Control knob for grill
- ④ Burner control knob for front right burner
- ⑤ Burner control knob for rear right burner
- ⑥ Power burner, front
- ⑦ Power burner, rear
- ⑧ Thermostatically controlled ceramic burner
- ⑨ Grill
- ⑩ Grates
- ⑪ Simmer burner

KMR 1136-1

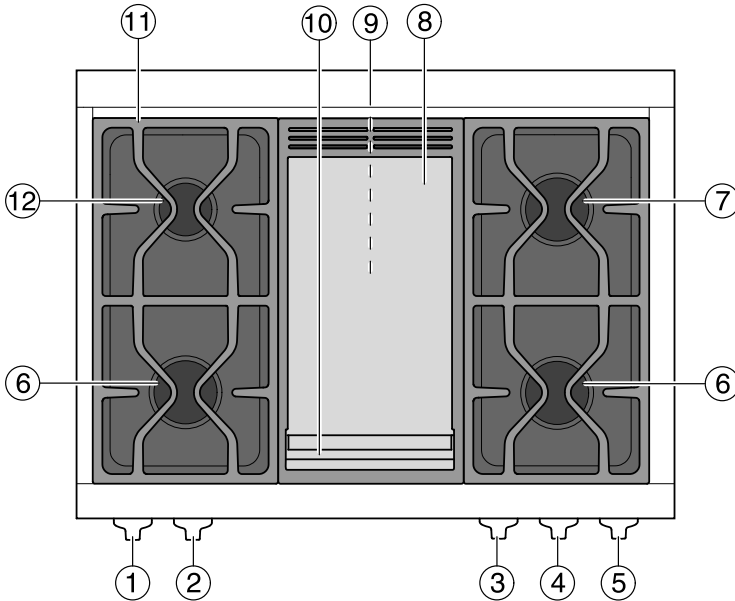

- ① Burner control knob for rear left burner
- ② Burner control knob for front left burner
- ③ Control knob for griddle plate
- ④ Burner control knob for front right burner
- ⑤ Burner control knob for rear right burner
- ⑥ Power burner, front
- ⑦ Power burner, rear
- ⑧ Griddle plate
- ⑨ Thermostatically controlled ceramic burner
- ⑩ Grease drip tray
- ⑪ Grates
- ⑫ Simmer burner

Guide to the Rangetop

KMR 1354-1

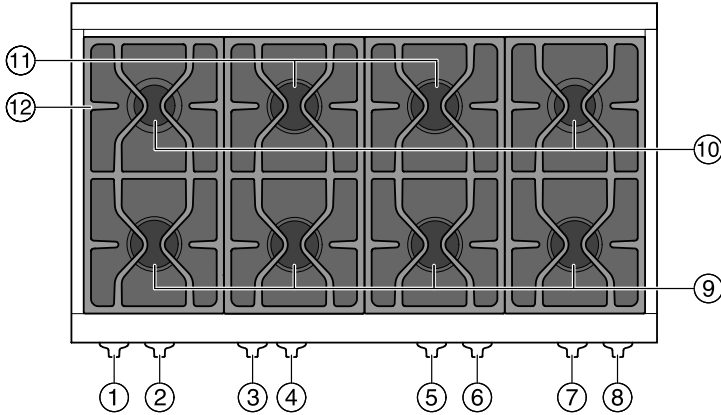

- ① Backlit burner control knob for rear left burner
- ② Backlit burner control knob for front left burner
- ③ Backlit burner control knob for rear left center burner
- ④ Backlit burner control knob for front left center burner
- ⑤ Backlit burner control knob for front right center burner
- ⑥ Backlit burner control knob for rear right center burner
- ⑦ Backlit burner control knob for front right burner
- ⑧ Backlit burner control knob for rear right burner
- ⑨ Power burner, front
- ⑩ Simmer burner
- ⑪ Power burner, rear
- ⑫ Grates

KMR 1355-1

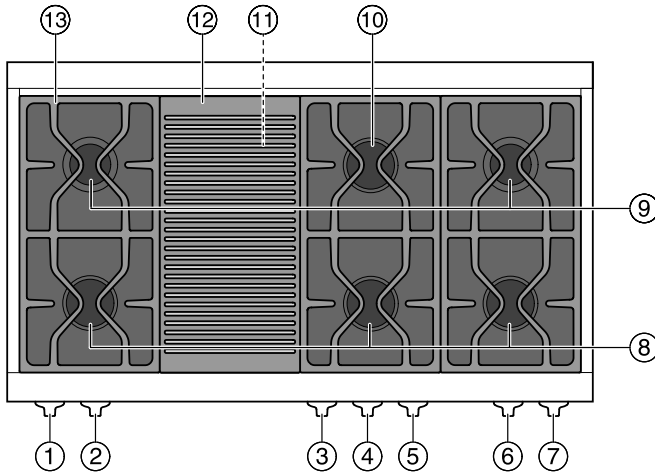

- ① Backlit burner control knob for rear left burner
- ② Backlit burner control knob for front left burner
- ③ Backlit control knob for grill
- ④ Backlit burner control knob for front center burner
- ⑤ Backlit burner control knob for rear center burner
- ⑥ Backlit burner control knob for front right burner
- ⑦ Backlit burner control knob for rear right burner
- ⑧ Power burner, front
- ⑨ Simmer burner
- ⑩ Power burner, rear
- ⑪ Thermostatically controlled ceramic burner
- ⑫ Grill
- ⑬ Grates

Guide to the Rangetop

KMR 1356-1

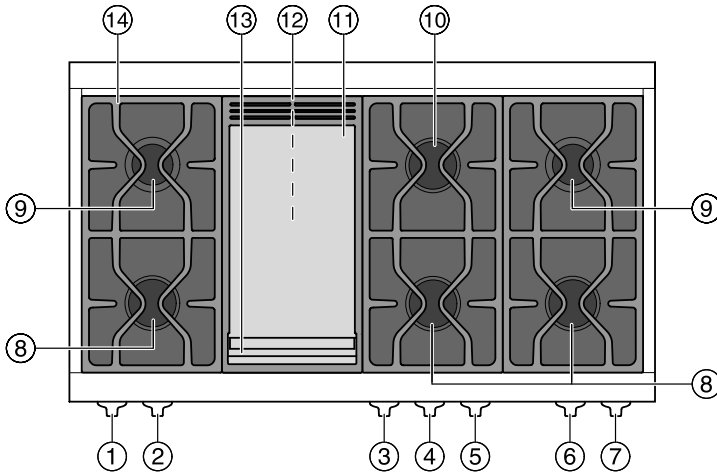

- ① Backlit burner control knob for rear left burner
- ② Backlit burner control knob for front left burner
- ③ Backlit control knob for griddle plate
- ④ Backlit burner control knob for front center burner
- ⑤ Backlit burner control knob for rear center burner
- ⑥ Backlit burner control knob for front right burner
- ⑦ Backlit burner control knob for rear right burner
- ⑧ Power burner, front
- ⑨ Simmer burner
- ⑩ Power burner, rear
- ⑪ Griddle plate
- ⑫ Thermostatically controlled ceramic burner
- ⑬ Grease drip tray
- ⑭ Grates

 Fire hazard due to overheated food.

Unattended food can overheat and ignite.

Do not leave the cooktop unattended whilst it is being used.

Do not turn the control knobs to the right beyond "Off".

A spark may be generated on all burners when a control knob is turned on. This is normal and does not indicate an appliance defect.

A brief reignition may occur during activation (clicking 1–2 x), e.g., in case of a draft.

Automatic re-ignition

Your rangetop is equipped with an automatic re-ignition function. If the flame goes out, e.g. because food has cooked over or there has been an air draft, the flame is automatically re-ignited.

 If there has been a power failure, the automatic re-ignition feature will not work properly.

Operate the cooktop only under supervision. If the burner has not ignited or the flame goes out, turn off the burner knob.

Before first use

Cleaning the rangetop for the first time

- Remove any protective foil and stickers.
- Using a soft sponge, clean all removable burner parts with a solution of warm water and a small amount of liquid dish soap. Dry the parts thoroughly after cleaning and reassemble the burners (see “Cleaning and care”).
- Remove the grilling grate and, using a soft sponge, clean it with a solution of warm water and a small amount of dishwashing liquid. Dry it thoroughly after cleaning.
- The griddle plate is oiled for protection against corrosion. Clean the griddle plate with a soft sponge, a small amount of dishwashing liquid, and warm water, and dry it.
- Before first use, wipe down the appliance with a damp cloth and dry it.

Metal components are protected by a conditioning agent. Smells and vapor may occur when the appliance is used for the first time.

The smell and any vapors do not indicate a faulty connection or a defective appliance and are not harmful to your health.

Seasoning the griddle plate

You must season the griddle plate before cooking food on it the first time. This process prevents food from sticking and protects the surface from moisture.

- Set the griddle plate on “High” for 30 minutes.
- Turn off the griddle plate after 30 minutes and let it cool down.

During heating, the griddle plate constantly changes color. The discoloration may become more intensive over time. The properties of the griddle plate, however, are not impaired in this manner.

- Pour 1 teaspoon of vegetable oil that can be heated to a high temperature in the middle of the cooled griddle plate and distribute it with a paper towel, leaving out the corners of the plate.

Do not use too much oil. Excess oil leaves a rubbery substance on the plate that has to be removed.

- Remove any excess oil with a paper towel.
- Heat the griddle plate on “High” until it starts to smoke.
- Turn off the griddle plate.
- When the griddle plate has cooled down to a safe temperature, wash off the excess oil.
- Repeat the process once the griddle plate has cooled down completely.

Operation of the burners

Turning on

- To ignite a burner, push the appropriate control knob and turn it counterclockwise to the “High” position. The ignitor “clicks” and ignites the gas.
- If the burner fails to light, turn the control knob to the “Off” position. Air the room or wait at least 1 minute before trying again.
- If the second attempt also fails to light the burner, turn the control knob to the “Off” position and refer to the “Frequently asked questions” section.

Control Knob

- | | |
|---------------|--|
| Off | Gas supply is off:
Burner off |
| High | Strongest flame setting:
Maximum power of upper
and lower flame rings |
| Simmer | Weakest flame setting:
Upper flame ring off
Minimum power of lower
flame ring |

Turning on during a power outage

In case of a power failure, the flame can be ignited manually.

- Press in the burner knob and turn it counterclockwise to “High.”
- Light the emerging gas/air mixture with a match.

Operation of the burners

Adjusting the flame

The burners can be variably adjusted between the lowest and highest flame settings.

Because the edges of the flame are much hotter than its center, the flame tips should stay beneath the bottom of the cookware. Flame tips which extend beyond the sides of the cookware emit unnecessary heat into the room and can also damage cookware handles, which increases the risk of injury.

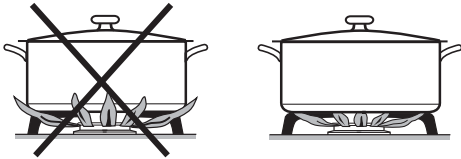

- Adjust the flame so that it never extends up the sides of the cookware.

Visual characteristics gas flames

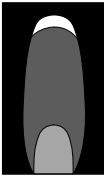
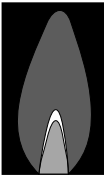
	Yellow flames Contact the Miele Service Department.
	Yellow tips on outer cones Normal for propane gas
	Soft blue flames yellow colour is only allowed at the tip of the inner cone Normal for natural gas

Turning off

Do not turn the control knob clockwise past the "Off" position.

- Turn the control knob to the right until it reaches the "Off" position.

This stops the flow of gas, and the flame goes out.

- Select cookware that fits the size of the burner:
Large diameter = large burner
Small diameter = small burner
- Do not use pots or pans that have bottoms with pronounced edges.



- Using cookware that is too large can cause the flames to spread out and damage the surrounding countertop or other appliances. Choosing the right cookware size improves efficiency.
- Any cookware that has a diameter smaller than the burner grate or which does not rest in a stable position on the grate (without wobbling) is dangerous and should not be used.
- Unlike cookware that is used on an electric cooktop, the bottom of cookware used on a rangetop does not have to be flat to deliver effective cooking performance.
- When purchasing pots and pans, keep in mind that the diameter indicated is typically the top diameter, not the bottom diameter.
- All heat-resistant cookware is suitable for use.
- Cookware with a thick bottom is preferable, as it distributes heat more evenly. Cookware with a thin bottom may cause food to overheat in certain spots. To avoid this, stir the food frequently.
- Always place cookware on the burner grate supplied with the rangetop. Never place it directly on the burner.
- Position the cookware on the burner grate so that it cannot tip. There is always a possibility of a slight tilt, despite the proper position.

Energy saving tips

- Whenever possible, keep pots and pans covered while cooking. Doing so will prevent unnecessary heat loss.
- Wide, shallow cookware heats up faster and is therefore preferable to tall, narrow cookware.
- Cook with as little water as possible.
- Reduce the power setting once the water has come to a boil or the oil/fat is hot enough for frying.
- Use a pressure cooker to reduce the cooking time.

Operation of the grill

The grill has a ceramic burner that transfers intense heat to food, searing the outside to seal the juices. Full flexibility, depending on the food, from “Low” to “High” as power settings.

Assembling the grill



Burn hazard!

The burners must be turned off and allowed to cool completely.



Risk of injury!

The cast-iron grill is heavy. Carry the grill carefully and place it securely on a soft base so that it lies flat.

- Place the radiant plate ② on top of the frame ③.

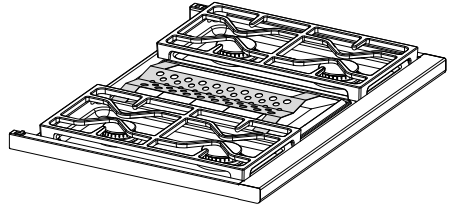

- Place the grill ① into position.

Cleaning and care

Tip: All parts can be disassembled in the reverse order. You can also remove the frame for cleaning.

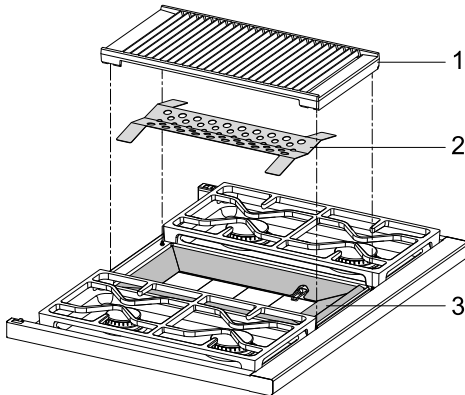

- ① Grill
- ② Radiant plate
- ③ Frame

- Using a soft sponge, clean radiant plate ② with a solution of warm water and a small amount of liquid dish soap. Dry the parts thoroughly after cleaning.
- Remove the grill ① from the gas cooktop.

Operation of the grill

Do not use cooking utensils on the grill.

Turning on the grill

Always follow USDA guidelines on food safety.

- Press the control knob of the grill and turn it counterclockwise to “High.”
- If the burner fails to light, turn the control knob to the “Off” position. Air the room or wait at least 1 minute before trying again.
- If the second attempt also fails to light the burner, turn the control knob to the “Off” position and refer to the “Frequently asked questions” section.
- Pre-heat the grill with the grate in place for approx. 20 minutes.
- Set the desired power level.

Control knob

Off	Gas supply is off: Grill off
High	Maximum power
Low	Minimum power

Turning on during a power outage

 Danger of injury due to the manual ignition of the flat burner during a power failure!

Never operate the grill during a power failure.

- Turn off the grill control knob.

Tips for grilling

 Fire hazard!
Do not leave the appliance unattended while cooking!

- Pat down wet food items with paper towel to prevent splatters during grilling.
- Do not salt meat until after grilling, or it will be too dry.
- Select lean meat or cut off fat before grilling. Dripping fat can catch on fire.
- If dripping fat catches on fire, use grilling tongs to move the meat to another spot or remove it entirely.
- Remove chicken skin to prevent sparking.
- Halfway through cooking, brush marinade onto the food.
- Leave the grill on for another 10 minutes after you have finished grilling. This makes cleaning easier after cooking.

Operation of the griddle

The griddle is thermostatically controlled to maintain a consistent temperature. To prevent food from sticking, it is necessary to “season” the griddle prior to use (see “Before using for the first time”). Full flexibility, depending on the food, from “Low”, “Medium” and “High” as power settings.

Turning on the griddle

Always observe USDA food safety guidelines.

- Press the control knob of the griddle and turn it counterclockwise to “Low.”
- If the burner fails to light, turn the control knob to the “Off” position. Air the room or wait at least 1 minute before trying again.
- If the second attempt also fails to light the burner, turn the control knob to the “Off” position and refer to the “Frequently asked questions” section.
- Preheat the griddle plate for about 20 minutes.
- Set the desired power level.

Control knob

Off	Gas supply is off: Griddle off
Low	Minimum power
Medium	Medium power
High	Maximum power

Operation of the griddle

Turning on during a power outage

The griddle plate cannot be operated in case of a power failure.

- Turn off the control knob for the griddle plate.

Settings

Settings	Food
Low	Simmering Sauce
	Holding food temperature
Medium	Eggs
	Bacon
	French Toast
Medium-High	Fish
	Pancakes
	Sausage
	Hash Browns
	Vegetables
High	Burgers
	Steaks
	Stir-fry

Tips for frying

Before each use, wipe the griddle with a damp cloth to remove dust or other residue.

- Pre-heat the griddle plate thoroughly for 8–10 minutes at the power level that you are going to be using for cooking.
- Pat down wet food items with paper towel to prevent splatters during grilling.
- Do not salt meat until after grilling, or it will be too dry.
- For cooking with the griddle plate, you need only a little fat or none in the case of marinated food. If you use cooking fat, do not put it on the griddle plate until it is hot.
- Only use fats/oils that can tolerate high temperatures.
- Marinating often improves the flavor of food to be cooked.



Danger of burns!

The burners must be turned off and the rangetop must be cooled.



Danger of injury!

The steam from a steam cleaner could reach electrical components and cause a short circuit.

Do not use a steam cleaner to clean the rangetop.

All rangetop surfaces can become discolored or damaged if unsuitable cleaning agents are used.

All surfaces are susceptible to scratching.

Remove any cleaning agent residues immediately.

Always clean the rangetop after each use. Allow it to cool down before cleaning.

To better maintain your appliance avoid the following:

- cleaners containing soda, ammonia, thinners, or chlorides
- descaling agents
- Stain or rust removers
- Abrasive cleaning agents (e.g., powder or cream cleansers, pumice stones)
- solvent-based cleaners
- dishwasher detergent
- grill and oven sprays
- glass cleaning agents
- hard, abrasive brushes or sponges (e.g. pot scrubbers or scrub sponges, sponges which have previously been used with abrasive cleaning agents)
- sharp objects (these could damage the seals between the ceramic and the frame or between the frame and the counter-top).

Cleaning and care

Rangetop

The surfaces of the burner components and grates will slightly lose their luster over time. This is completely normal and does not indicate damage to the material.

- Clean the entire rangetop after each use with a soft sponge, warm water and a small amount of liquid dish soap.
- Pre-soak any stubborn dirt or grime before cleaning.
- Dry the rangetop after using water to clean it. This helps prevent lime deposits.

Tip: Food that has cooked over onto a hot rangetop can cause the burner components to become discolored. Immediately remove all spilled food and all salt or sugar splatters!

Dishwasher-safe grates

- Remove the burner grates.
- Clean the grates in the dishwasher or using a soft sponge with warm water and a small amount of liquid dish soap.
- If necessary, the rough side of a kitchen sponge can be used.

Burner control knobs with stainless steel finish

The burner control knobs may become discolored if they are not cleaned regularly.

Do not clean the burner control knobs in a dishwasher or with a stainless steel cleaner.

Clean the knobs with a soft sponge, warm water and a small amount of liquid dish soap.

Simmer burner / Power burners

The burner cap is not dishwasher-safe.

Make sure that the flame holes are completely dry after cleaning.

- Remove the burner cap.
- Clean the burner cap using a soft sponge, warm water and a small amount of liquid dish soap.
- All parts of the burner which cannot be removed should be wiped down with a damp cloth.

Ignitor

Do not allow the ignitor to become wet. If it is wet, it will not spark.

- Gently wipe down the ignitor clean using a damp cloth.

Cleaning the dishwasher-safe grilling grate

- Clean the grilling grate in the dishwasher or with warm water and liquid dish soap. When the grilling rack is strongly soiled, soak it and then remove the soiling with a brush. After that, let the rack dry thoroughly.

Cleaning the griddle plate

 Burn hazard!

Allow the griddle plate to cool down sufficiently before cleaning it.

 Fire hazard!

Clean the grease catch pan after every use of the griddle plate.

- Loosen coarse soiling immediately with a spatula and scratch grease and residue into the grease catch pan.
- Remove any excess grease with a paper towel.
- Then let the griddle plate cool until it is safe to the touch, add some hot, soapy dishwater, and let the grime soak.
- Remove any soiling and water with a sponge.

You can clean stubborn soiling off the griddle plate with the rough side of a dish sponge and a few drops of Miele ceramic and stainless steel cleaner (see “Optional accessories”).

- Remove the grease catch pan and empty it.

- Clean the grease catch pan with a soft sponge, dishwashing liquid, and warm water. Dry it thoroughly after cleaning.
- Wipe off the griddle plate with clean water and dry it with a clean, dry cloth.
- Rub some vegetable oil into the griddle plate after every cleaning.
- Put the grease catch pan back into place.

Frequently Asked Questions

With the help of the following guide minor faults in the performance of the machine, some of which may result from incorrect operation, can be remedied without contacting the Service Department.

This guide may help you to find the reason for the fault, and how to correct it.

Problem	Possible cause and solution
The burners do not ignite when the cooktop is being used for the first time or after it has been out of use for a longer period.	There may be air in the gas line. ■ Try to light the burner again, making several attempts if necessary.
The burner does not light after several attempts.	The burner is not properly assembled. ■ Assemble the burner correctly.
	The gas shutoff valve is closed. ■ Open the gas shut-off valve.
	The burner is wet and/or dirty. ■ Clean and dry the burner.
	The flame holes are clogged and/or wet. ■ Clean and dry the flame holes.
The gas flame goes out after being lit.	The burner parts are not in the proper position. ■ Position the burner parts correctly.
	The ignitor is dirty. ■ Remove any dirt or grime.
The shape/color of the gas flame changes.	The burner parts are not in the proper position. ■ Position the burner parts correctly.
	The burner cap itself or the holes in the burner cap are dirty. ■ Remove any dirt or grime.
The gas flame goes out during use.	The burner parts are not in the proper position. ■ Position the burner parts correctly.

Frequently Asked Questions

Problem	Possible cause and solution
The ignitor does not function properly.	The fuse in the building's wiring system was tripped. ■ If necessary, contact a qualified electrician or Customer Service for assistance.
	There is food debris stuck between the ignitor and the burner cap. ■ Remove the debris. (See “Cleaning and care” for more information.)

Notes on installation

Distance to the range hood

The minimum clearance between the appliance and a range hood above will be listed by the hood manufacturer.

If there is more than one appliance installed below the range hood, each with a different safety clearance, the largest clearance must be used.

RBGDF Backguard

Depending on the model, you can exchange the existing island trim of your appliance for a larger range backguard. The backguard is available in the following heights: 12" (305 mm) and 20" (508 mm).

Installing the backguard

The rear of the rangetop must be accessible.

Install the backguard before connecting the rangetop.

- Loosen the screws of the island trim.
- Pull back the island trim slightly until it can be removed.

The backguard can be **installed** in reverse order.

Weights

The net weight of the rangetop with accessories is as follows:

Model	Width	Net weight including grates and burner caps
KMR 1124	29 ¹⁵ / ₁₆ " (762 mm)	approx. 100 lbs / 45 kg
KMR 1134-1 KMR 1135-1 KMR 1136-1	35 ¹⁵ / ₁₆ " (915 mm)	approx. 120 lbs / 55 kg approx. 130 lbs / 60 kg approx. 151 lbs / 68.5 kg
KMR 1354-1 KMR 1355-1 KMR 1356-1	47 ¹⁵ / ₁₆ " (1220 mm)	approx. 150 lbs / 68 kg approx. 160 lbs / 73 kg approx. 170 lbs / 78 kg

Dimensional drawings

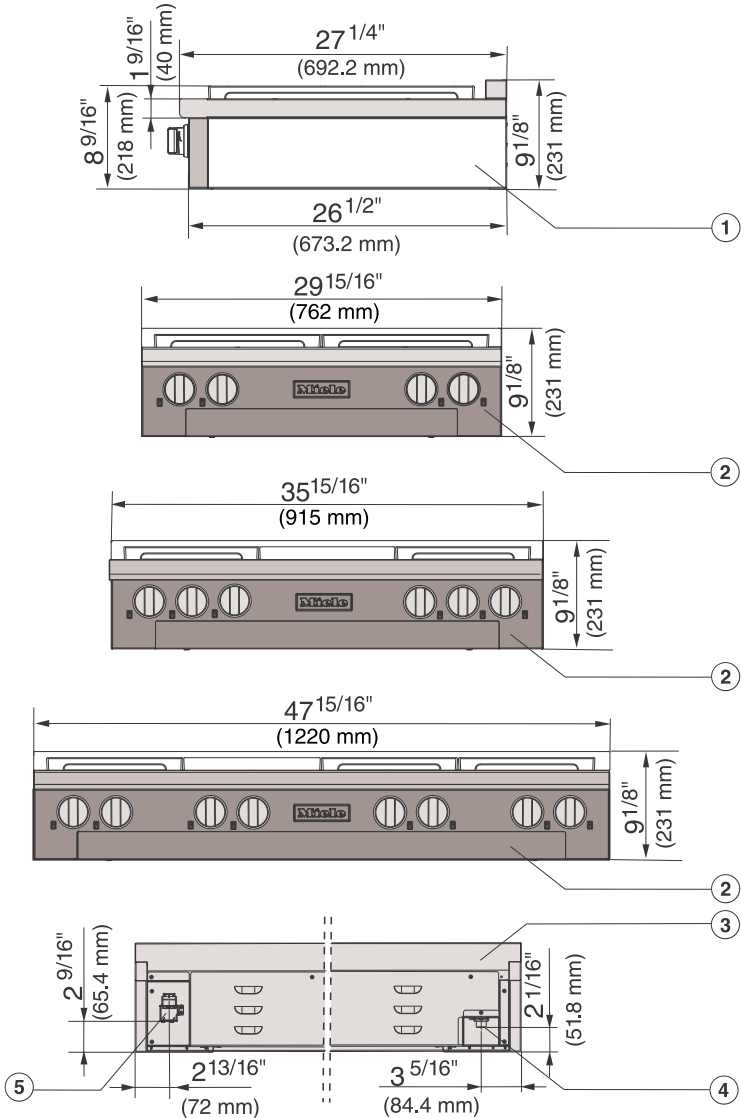

- ① Side view
- ② Front views
- ③ Rear view
- ④ Gas connection
- ⑤ Electrical connection

Rangetops KMR 1124, KMR 113x-1, KMR 135x-1

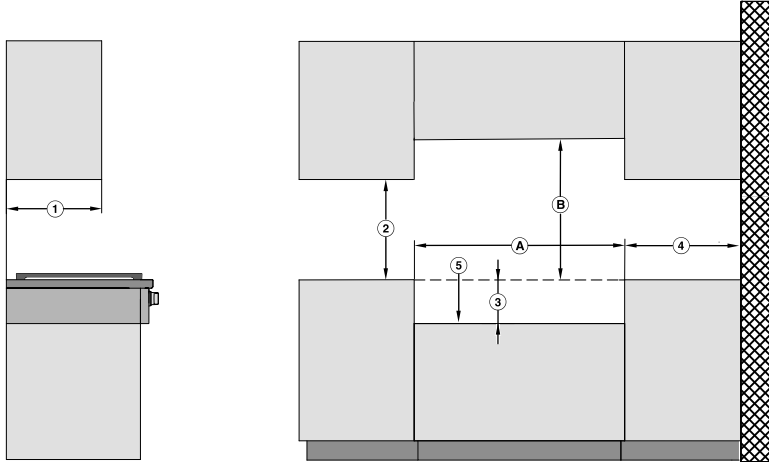

Position	Dimensions	Description
①	13" (330 mm)	Maximum depth of top cabinet
②	18" (457 mm)	Minimum distance to bottom edge of top cabinet
③	7 ¹ / ₂ " (190.5 mm)	Distance between the top edge of the countertop and the top edge of the support base
④	10" (254 mm)	Minimum distance to combustible surfaces
⑤		Support base ¹⁾

1) The support base must have a minimum thickness of $\frac{3}{4}$ " (19.05 mm).

At the rear right of the support base, a cut-out of 5 $\frac{1}{8}$ " x 7 $\frac{1}{8}$ " (130 mm x 80 mm) must be provided (gas connection) and, at the rear left, a cut-out of 4 $\frac{6}{8}$ " x 1 $\frac{9}{16}$ " (120 mm x 40 mm) (electrical connection).

Dimensional drawings

KMR 1124

Position	Dimensions	Description
Ⓐ	min. 30" (762 mm)	Niche width
Ⓑ	37" (940 mm)	Minimum distance between the top of the cooking area and the bottom of an unprotected combustible surface.
	30" (762 mm)	Minimum distance between the top of the cooking area and the bottom of the Miele Range Hood (DAR model with DRxB XL blower).
	For all other hoods please consult the manufacturer's specifications for required distances.	

Please observe safe distances to rear combustible surfaces of 12" (305 mm) clearance. For zero clearance installation the Miele Backguards will satisfy the required distance to combustible surfaces. The Miele Backguard is available in 12" (305 mm) or 20" (508 mm) heights.

KMR 1134-1

Position	Dimensions	Description
Ⓐ	min. 36" (915 mm)	Niche width
Ⓑ	37" (940 mm)	Minimum distance between the top of the cooking area and the bottom of an unprotected combustible surface.
	36" (915 mm)	Minimum distance between the top of the cooking area and the bottom of the Miele Range Hood (DAR model with DRxB XL blower).
	30" (762 mm)	Minimum distance between the top of the cooking area and the bottom of the Miele Range Hood (DAR model with DRxB XXL blower).
	<p>Refer to the Installation instructions for the Miele ventilation hood, Appliance dimensions (Distance between cooktop and ventilation hood (S)).</p> <p>For all other hoods please consult the manufacturer's specifications for required distances.</p>	

Please observe safe distances to rear combustible surfaces of 12" (305 mm) clearance. For zero clearance installation the Miele Backguards will satisfy the required distance to combustible surfaces. The Miele Backguard is available in 12" (305 mm) or 20" (508 mm) heights.

Dimensional drawings

KMR 1135-1, KMR 1136-1

Position	Dimensions	Description
Ⓐ	min. 36" (915 mm)	Niche width
Ⓑ	37" (940 mm)	Minimum distance between the top of the cooking area and the bottom of an unprotected combustible surface.
	30" (762 mm)	Minimum distance between the top of the cooking area and the bottom of the Miele range hood (DAR model with DRxB XL blower or DRxB XXL blower).
	<p>Refer to the Installation instructions for the Miele ventilation hood, Appliance dimensions (Distance between cooktop and ventilation hood (S)).</p> <p>For all other hoods please consult the manufacturer's specifications for required distances.</p>	

Please observe safe distances to rear combustible surfaces of 12" (305 mm) clearance. For zero clearance installation the Miele Backguards will satisfy the required distance to combustible surfaces. The Miele Backguard is available in 12" (305 mm) or 20" (508 mm) heights.

Dimensional drawings

KMR 1354-1, KMR 1355-1, KMR 1356-1

Position	Dimensions	Description
Ⓐ	min. 48" (1220 mm)	Niche width
Ⓑ	37" (940 mm)	Minimum distance between the top of the cooking area and the bottom of an unprotected combustible surface.
	30" (762 mm)	Minimum distance between the top of the cooking area and the bottom of the Miele Range Hood (DAR model with DRxB XXL blower).
	<p>Refer to the Installation instructions for the Miele ventilation hood, Appliance dimensions (Distance between cooktop and ventilation hood (S)).</p> <p>For all other hoods please consult the manufacturer's specifications for required distances.</p>	

Please observe safe distances to rear combustible surfaces of 12" (305 mm) clearance. For zero clearance installation the Miele Backguards will satisfy the required distance to combustible surfaces. The Miele Backguard is available in 12" (305 mm) or 20" (508 mm) heights.

Electrical connection

ATTENTION:

During installation, maintenance and repair work, the rangetop must be disconnected from the electricity supply. It is only completely isolated from the electricity supply if the plug fuses have been fully unscrewed (where applicable), the main circuit breaker has been tripped or the power cable has been unplugged from the wall outlet.

Do not cut off the plug on the power cord. If the plug does not fit in the outlet, have an electrician install an appropriate outlet.

The socket must be easily accessible after the rangetop has been installed.

Installation, repair and maintenance work should only be performed by a Miele authorized service technician. Work by unqualified persons can cause considerable danger to users. Miele cannot be held liable for any damage arising as a result of such work.

To avoid damaging the rangetop, make sure that the information (voltage and frequency) on the data plate correspond to the building's power supply before connecting the appliance.

When in doubt, consult a qualified electrician.

The plug must be inserted into a suitable outlet that has been installed and grounded in compliance with all applicable local regulations.

WARNING: THIS APPLIANCE MUST BE GROUNDED

Installer: Please pass these instructions on to the customer.

Electrical connection

The rangetop is equipped with an approx. 4 ft. long power cord with a plug for connection to the electrical supply with:

- 120 V, 15 A, 60 Hz

SAVE THESE INSTRUCTIONS FOR THE ELECTRICAL INSPECTOR'S USE.

This appliance must be grounded in compliance with all applicable local and national regulations.

Installation, repair and maintenance work should only be performed by a Miele authorized service technician in compliance with local regulations and the ANSI National Electrical Code / NFPA 70 in the United States or the Canadian Electrical Code, Part I in Canada (CSA standard C22.1).

 Connection to the gas supply may only be performed by a duly authorized technician. This technician is responsible for proper function at the installation site. In Massachusetts, the gas connection may be performed only by a certified gas installer.

The rangetop must be connected with its own shut-off valve. The shut-off valve must be accessible and visible, after the opening of a cabinet door, if necessary.

The gas connection of the rangetop can be to natural gas or propane gas according to the model. Ask your gas company what kind of gas is used and compare it with the specifications on the data plate.

The rangetop is not connected to an exhaust vent. During the setup and connection of the rangetop, observe the applicable installation conditions, especially suitable ventilation measures.

The gas connections must be arranged in such a way that they are not heated and damaged by the operation of the range. In particular, make sure that the gas hose lines and connection fittings on the rangetop do not come into contact with hot exhaust gases.

The gas hose and power cord could be damaged by hot spots on the rangetop. Make sure that the gas hose and power cord do not come into contact with hot spots on the rangetop.

Flexible connection lines can be damaged by incorrect routing. Attach flexible connecting lines in such a way so that they do not come into contact with any moving kitchen parts (e.g., a drawer) and are not exposed to mechanical stress.

The rangetop and the shut-off valve must be disconnected from the gas supply during gas pressure tests. Disconnect the rangetop and the shut-off valve from the gas supply before performing a gas pressure test at a pressure of more than 1/2 psi (3.5 kPa). Close the shut-off valve of the gas supply before performing a gas pressure test at a pressure of less than or equal to 1/2 psi (3.5 kPa).

Incorrectly sealed gas lines can lead to a gas leak and thus to an explosion. Seal all gas lines with a suitable thread sealant.

Seal tightness tests on the rangetop must be performed according to manufacturer specifications.

Gas connection

The gas connection must be made in accordance with local codes or, in the absence of local codes, with:
National Fuel Gas Code
ANSI Z 223.1 / NFPA No. 54 for the United States or the current Can / CGA B 149.1 and 2 Installation Codes of Gas Appliances for Canada.

The gas pressure may not under-shoot or exceed certain values.
Make sure that the maximum gas pressure upstream of the gas pressure controller does not amount to more than 1/2 psi (3.5 kPa) for natural and propane gas.
Make sure that the minimum gas pressure amounts to a 6" water head in the case of natural gas and a 11" (279.4 mm) water head in the case of propane gas.

Burner ratings KMR 1124

Natural gas NG	Btu/hr	kW
Simmer burner	12,500	3.7
Power burner	19,500	5.7
Total cooktop output	71,000	20.8

Liquid propane LP	Btu/hr	kW
Simmer burner	12,500	3.7
Power burner	19,500	5.7
Total cooktop output	71,000	20.8

Burner ratings

Burner ratings KMR 1134-1

Natural gas NG	Btu/hr	kW
Simmer burner	12,500	3.7
Power burner, rear	13,600	4.0
Power burner, front	19,500	5.7
Total cooktop output	98,200	28.8

Liquid propane LP	Btu/hr	kW
Simmer burner	12,500	3.7
Power burner, rear	13,000	3.8
Power burner, front	19,500	5.7
Total cooktop output	97,000	28.4

Burner ratings KMR 1135-1

Natural gas NG	Btu/hr	kW
Simmer burner	12,500	3.7
Power burner, rear	13,600	4.0
Power burner, front	19,500	5.7
Grill	19,000	5.6
Total cooktop output	84,100	24.6

Burner ratings

Burner ratings KMR 1136-1

Natural gas NG	Btu/hr	kW
Simmer burner	12,500	3.7
Power burner, rear	13,600	4.0
Power burner, front	19,500	5.7
Griddle	13,000	3.8
Total cooktop output	78,100	22.9

Liquid propane LP	Btu/hr	kW
Simmer burner	12,500	3.7
Power burner, rear	13,000	3.8
Power burner, front	19,500	5.7
Griddle	14,300	4.2
Total cooktop output	78,800	23.1

Burner ratings KMR 1354-1

Natural gas NG	Btu/hr	kW
Simmer burner	10,000	2.9
Power burner, rear	13,600	4.0
Power burner, front	19,500	5.7
Total cooktop output	125,200	36.7

Liquid propane LP	Btu/hr	kW
Simmer burner	10,000	2.9
Power burner, rear	13,000	3.8
Power burner, front	19,500	5.7
Total cooktop output	124,000	36.3

Burner ratings

Burner ratings KMR 1355-1

Natural gas NG	Btu/hr	kW
Simmer burner	10,000	2.9
Power burner, rear	13,600	4.0
Power burner, front	19,500	5.7
Grill	19,000	5.6
Total cooktop output	111,100	32.6

Burner ratings KMR 1356-1

Natural gas NG	Btu/hr	kW
Simmer burner	10,000	2.9
Power burner, rear	13,600	4.0
Power burner, front	19,500	5.7
Griddle	13,000	3.8
Total cooktop output	105,100	30.8

Liquid propane LP	Btu/hr	kW
Simmer burner	10,000	2.9
Power burner, rear	13,000	3.8
Power burner, front	19,500	5.7
Griddle	14,300	4.2
Total cooktop output	105,800	31.0

Technical Service

Contact in case of fault

In the event of a fault which you cannot remedy yourself, please contact your Miele dealer or Miele Technical Service.

Contact information for Miele Technical Service can be found at the end of this document.

Please quote the model and serial number of your appliance when contacting Miele. Both pieces of information can be found on the data plate.

Warranty

For further information, please refer to your warranty booklet.

Data plate

Adhere the extra data plate supplied with the appliance in the space below. Make sure that the model number matches the one specified on the back cover of this document.

This service is available in USA only.

MieleCare, our Extended Service Contract program, gives you the assurance of knowing that your appliance investment is covered by 5 years of worry free ownership.

MieleCare is the only Extended Service Contract in the industry that guarantees repairs by a Miele Authorized Service Provider using genuine Miele parts. Only genuine Miele parts installed by factory trained professionals can guarantee the safety, reliability, and longevity of your Miele appliance.

Please note that unless expressly approved in writing by Miele's Service department, Extended Service Contracts offered by other providers for Miele products will not be recognized by Miele. Our goal is to prevent unauthorized (and untrained) service personnel from working on your Miele products, possibly doing further damage to them, you and/or your home.

To learn more about **MieleCare** Extended Service Contracts, please contact your appliance dealer or visit us online at:
www.mieleusa.com

Caring for the environment

Disposal of the packing material

The cardboard box and packing materials protect the appliance during shipping. They have been designed to be biodegradable and recyclable.

Ensure that any plastic wrappings, bags, etc. are disposed of safely and kept out of the reach of children. Danger of suffocation!

Disposal of your old appliance

Electrical and electronic appliances contain valuable materials. They also contain certain substances, compounds and components which were essential for the proper functioning and safe use of the equipment. Handling these materials improperly by disposing of them in your household waste can be harmful to your health and the environment. Therefore, please do not dispose of your old appliance with regular household waste and follow local regulations on proper disposal.



Consult with local authorities, dealers or Miele in order to dispose of and recycle electrical and electronic appliances. Miele assumes no responsibility for deleting any personal data left on the appliance being disposed. Please ensure that your old appliance is kept away from children until removal. Observe safety requirements for appliances that may tip over or pose an entrapment hazard.

Please have the model and serial number of your appliance available when contacting Customer Service.

The Miele logo consists of the word "Miele" in a bold, white, sans-serif font, set against a solid black rectangular background.

U.S.A.

Miele, Inc.

National Headquarters

9 Independence Way
Princeton, NJ 08540
Phone: 800-843-7231
Fax: 609-419-4298
www.mieleusa.com

Customer Service & Support

Phone: 888-99-MIELE(64353)
Fax: 888-586-8056
service@mieleusa.com

International Headquarters

Miele & Cie. KG
Carl-Miele-Straße 29
33332 Gütersloh
Germany

Canada

Importer
Miele Limited

Headquarters and Miele Centre

161 Four Valley Drive
Vaughan, ON L4K 4V8
www.miele.ca

Customer Care Centre

Phone: 800-565-6435
905-532-2272
customercare@miele.ca

KMR 1124, KMR 1134-1, KMR 1135-1, KMR 1136-1,
KMR 1354-1, KMR 1355-1, KMR 1356-1