

KM 5627 240V

Electric cooktop

with a width of 36 1/8 (915) in (mm) 36 1/8 (915) in (mm) for ultra-convenient cooking.

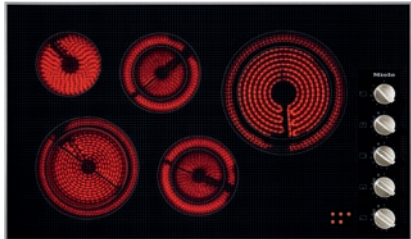

- Easy and direct controls – operation via knob controls
- Attractive design – 36 1/8 (915) in (mm) wide with stainless steel frame
- Versatile – 5 cooking zones
- Safe – residual heat indicator for every cooking zone

EAN: 4002514865935 / Material number: 07821700 / Old Material Number: 26562750USA

Heating type	
Fuel type	Electrical
Construction type	
Independent of oven	•
Design	
Elegant glass ceramic surface	•
Ceramic surface colour	Black
Stainless steel frame	•
Print design	Basalt grey decor
Proud installation	•
Ring features	
No. of rings	5
1st cooking zone/cooking area	
Position	front left
Type	Variable cooking zone
Size in mm	Ø 180 / Ø 230
Max. rating in W	1600/2500
2nd cooking zone/cooking area	
Position	rear left
Type	Single-circuit ring
Size in mm	Ø 145
Max. rating in W	1200
3rd cooking zone/cooking area	
Position	rear center
Type	Variable cooking zone
Size in mm	Ø 120 / Ø 180
Max. rating in W	700/1800
4th cooking zone/cooking area	
Position	right
Type	Variable cooking zone
Size in mm	Ø 210 / Ø 270
Max. rating in W	2000/3100
5th cooking zone/cooking area	
Position	front center
Type	Variable cooking zone
Size in mm	Ø 120 / Ø 180
Max. rating in W	700/1800
Control panel	
Operation via knobs	•
User convenience	
Operation via sensor controls	Knob
Extended cooking zone	•
Display colour	Red
Efficiency and sustainability	
Residual heat utilisation	•
Cleaning convenience	
Easy to clean ceramic glass	•
Safety	
Overheating protection	•
Residual heat indicator	•

KM 5627 240V

Electric cooktop

with a width of 36 1/8 (915) in (mm) 36 1/8 (915) in (mm) for ultra-convenient cooking.

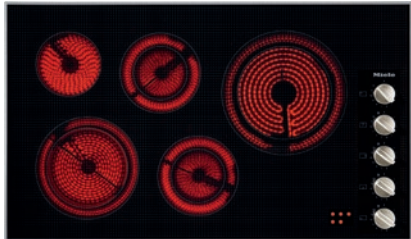

EAN: 4002514865935 / Material number: 07821700 / Old Material Number: 26562750USA

Technical data

Dimensions (H x W x D) in inches (mm)	
Dimensions (width) in in. (mm)	36 1/8 (915)
Height in in. (mm)	3 1/4 (81)
Dimensions in mm (depth)	21 1/2 (544)
Cutout dimensions (width) in in. (mm)	34 1/2 (876)
Casing height incl. connection box in mm	3 (75)
Cutout dimensions (depth) in in. (mm)	20 1/2 (518)
Weight in lbs. (kg)	41 (19)
Total connected load in kW	10.40
Power cord length in in. (m)	4 (1.4)
Voltage in V	240
Frequency in Hz	60

Accessories supplied

Razor-blade scraper	•
Number of mains cables with plug	Yes

KM 5627 240V

Electric cooktop

with a width of 36 1/8 (915) in (mm) 36 1/8 (915) in (mm) for ultra-convenient cooking.

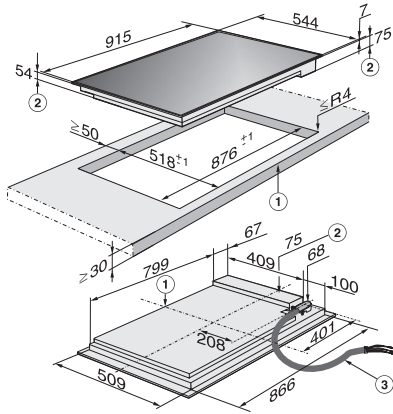

KM 5627 (Installation drawing)

1. Front, 2. Building-in depth, 3. Flexible metal hose, L = 1200 mm

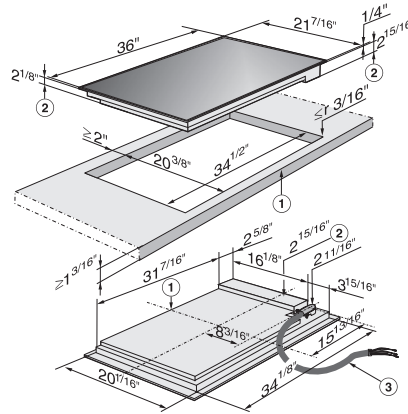

KM 5627 (Installation drawing)

1. Front, 2. Building-in depth, 3. Flexible metal hose, L = 47 1/4"