

KM 5621 240V

Electric cooktop

with four cooking zones and direct rotary dial controls for maximum convenience.

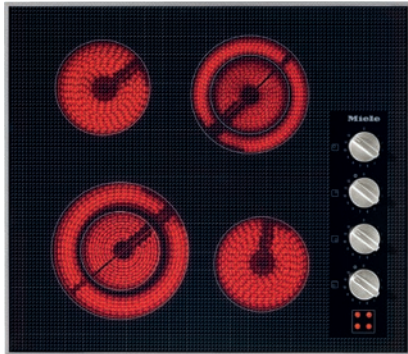

- Easy and direct controls – operation via knob controls
- Attractive design – 24 3/4 (626) in (mm) wide with stainless steel frame
- Versatile – 4 cooking zones
- Safe – residual heat indicator for every cooking zone

EAN: 4002514865898 / Material number: 07821660 / Old Material Number: 26562150USA

Heating type	
Fuel type	Electrical
Construction type	
Independent of oven	•
Design	
Elegant glass ceramic surface	•
Ceramic surface colour	Black
Stainless steel frame	•
Print design	Basalt grey decor
Proud installation	•
Ring features	
No. of rings	4
1st cooking zone/cooking area	
Position	front left
Type	Variable cooking zone
Size in mm	Ø 120 / Ø 210
Max. rating in W	900/2400
2nd cooking zone/cooking area	
Position	rear left
Type	Single-circuit ring
Size in mm	Ø 145
Max. rating in W	1200
3rd cooking zone/cooking area	
Position	rear right
Type	Variable cooking zone
Size in mm	Ø 120 / Ø 180
Max. rating in W	700/1800
4th cooking zone/cooking area	
Position	front right
Type	Single-circuit ring
Size in mm	Ø 145
Max. rating in W	1200
Control panel	
Operation via knobs	•
User convenience	
Extended cooking zone	•
Display colour	Red
Efficiency and sustainability	
Residual heat utilisation	•
Cleaning convenience	
Easy to clean ceramic glass	•
Safety	
Overheating protection	•
Residual heat indicator	•
Technical data	
Dimensions (H x W x D) in inches (mm)	
Dimensions (width) in in. (mm)	24 3/4 (626)
Height in in. (mm)	3 1/4 (81)
Dimensions in mm (depth)	21 1/2 (544)
Cutout dimensions (width) in in. (mm)	22 3/8 (567)

KM 5621 240V

Electric cooktop

with four cooking zones and direct rotary dial controls for maximum convenience.

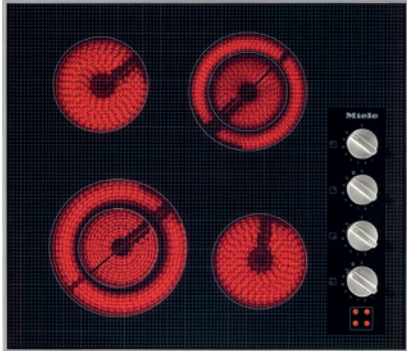

EAN: 4002514865898 / Material number: 07821660 / Old Material Number: 26562150USA

Casing height incl. connection box in mm	3 (75)
Cutout dimensions (depth) in in. (mm)	20 1/2 (518)
Weight in lbs. (kg)	28 (13)
Total connected load in kW	6.60
Power cord length in in. (m)	4 (1.4)
Voltage in V	240
Frequency in Hz	60
Accessories supplied	
Razor-blade scraper	•
Number of mains cables with plug	Yes

KM 5621 240V

Electric cooktop

with four cooking zones and direct rotary dial controls for maximum convenience.

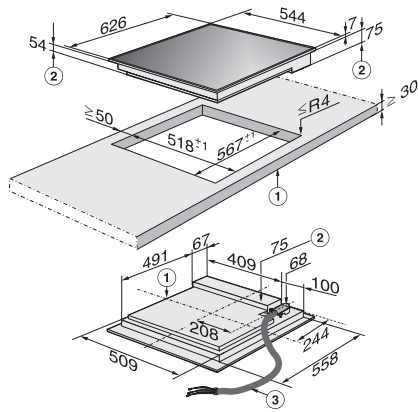

KM 5621 (Installation drawing)

1. Front, 2. Building-in depth, 3. Flexible metal hose, L = 1200 mm

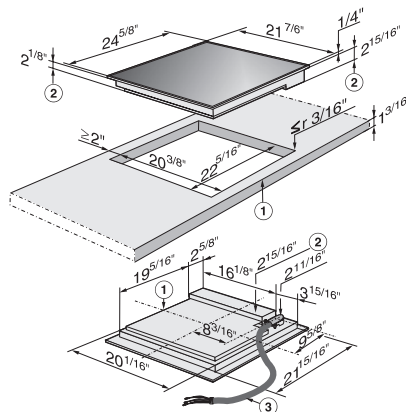

KM 5621 (Installation drawing)

1. Front, 2. Building-in depth, 3. Flexible metal hose, L = 47 1/4"