

Operating Instructions 48 Inch Dual Fuel Range (Speed Oven and Gourmet Warming Drawer)



It is **essential** to read the operating and installation instructions before setup, installation, and commissioning. This prevents both personal injury and damage to the appliance.

PRECAUTIONS TO AVOID POSSIBLE EXPOSURE TO EXCESSIVE MICROWAVE ENERGY

PRECAUTIONS TO AVOID POSSIBLE EXPOSURE TO EXCESSIVE MICROWAVE ENERGY

- (a) Do not attempt to operate this oven with the door open since open-door operation can result in harmful exposure to microwave energy. It is important not to defeat or tamper with the safety interlocks.

- (b) Do not place any object between the oven front face and the door or allow soil or cleaner residue to accumulate on sealing surfaces.

- (c) Do not operate the oven if it is damaged. It is particularly important that the oven door close properly and that there is no damage to the: (1) Door (bent), (2) hinges and latches (broken or loosened), (3) door seals and sealing surfaces.

- (d) The oven should not be adjusted or repaired by anyone except properly qualified service personnel.

IMPORTANT SAFETY INSTRUCTIONS

WARNING

Children and adults can tip over the range if has not been secured. This may lead to fatal injuries.

- ▶ This range must be secured and connected using the anti-tip device according to the installation instructions.
- ▶ If you have moved the range, slide the locking latch onto the anti-tip device until you feel it lock into place.
- ▶ Do not use the range if the anti-tip device has not been properly installed and engaged.
- ▶ Failure to observe the information contained in the installation instructions can lead to serious or fatal injuries for children and adults.

| | |
|--|--|
|  |  WARNING |
| | <p>All ranges can tip</p> <p>Injury to persons could result</p> <p>Install anti-tip devices packed with range</p> <p>See installation instructions</p> |

IMPORTANT SAFETY INSTRUCTIONS

⚠ WARNING: If the information in this manual is not followed exactly, a fire or explosion may result causing property damage, personal injury, or death.

- Do not use or store gasoline or other combustible liquids or vapors in the vicinity of this or any other appliance.
- WHAT TO DO IF YOU SMELL GAS
 - Do not try to light any appliance.
 - Do not touch any electric switches.
 - Do not use any phones inside your building.
 - Immediately call your gas supplier from a neighbor's phone. Follow the gas supplier's instructions.
 - If you are unable to reach your gas provider, call the fire department.
- Installation and service must be performed by a qualified installer, qualified service agency or your gas provider.
(In Massachusetts, installation must be performed by a licensed installer / gas fitter.)
- Note to the installer:
Please give these installation instructions to the consumer for the local electrical/gas inspector.



| | |
|---|----|
| PRECAUTIONS TO AVOID POSSIBLE EXPOSURE TO EXCESSIVE MICROWAVE ENERGY | 2 |
| IMPORTANT SAFETY INSTRUCTIONS | 3 |
| IMPORTANT SAFETY INSTRUCTIONS | 9 |
| Guide to the range | 25 |
| Relevant operating and installation instructions | 25 |
| Guide to the HR 195x-3 Gourmet warming drawer | 26 |
| Guide to the HR 195x-3 speed oven | 27 |
| Control panel | 28 |
| Control elements for the Gourmet Warming Drawer | 28 |
| Control elements for the speed oven | 29 |
| On/Off button | 30 |
| Proximity sensor (MotionReact) | 30 |
| Sensor buttons | 31 |
| Touch display | 32 |
| Symbols | 33 |
| Using the appliance | 34 |
| Selecting a menu option | 34 |
| Scrolling | 34 |
| Exiting a menu | 34 |
| Changing a value or setting | 34 |
| Changing a setting in a list | 34 |
| Entering numbers with the roller | 34 |
| Entering numbers using the numerical keypad | 34 |
| Changing the setting with a segment bar | 34 |
| Entering letters | 35 |
| Displaying the context menu | 35 |
| Moving entries | 35 |
| Displaying the pull-down menu | 35 |
| Displaying Help | 35 |
| Activating MobileStart | 35 |
| Features | 36 |
| Data plate | 36 |
| Extra data plates | 36 |
| Scope of delivery | 36 |
| Standard and optional accessories | 36 |
| Drawer safety features | 40 |
| Oven safety features | 40 |
| PerfectClean treated surfaces | 40 |
| Before first use | 41 |
| Miele@home | 41 |
| Miele@home for the Gourmet Warming Drawer | 42 |
| Heating up the drawer for the first time | 44 |

Contents

| | |
|--|----|
| Basic settings for the oven..... | 45 |
| Heating the oven for the first time..... | 46 |
| Operating the drawer | 47 |
| Opening and closing the drawer..... | 47 |
| Operating the drawer..... | 47 |
| Activating MobileStart..... | 48 |
| Selecting the operating mode..... | 48 |
| Setting the temperature..... | 49 |
| Setting the duration..... | 50 |
| Keeping food warm..... | 50 |
| Warming dishes..... | 53 |
| Other uses..... | 55 |
| Sabbath Program..... | 56 |
| Using the oven | 57 |
| Changing values and settings for a cooking program..... | 57 |
| Changing the temperature and core temperature..... | 58 |
| Changing the microwave power level..... | 58 |
| Setting additional durations..... | 58 |
| Changing set durations..... | 59 |
| Deleting the set cooking durations..... | 59 |
| Interrupting a cooking process in the Microwave operating mode..... | 59 |
| Canceling a cooking program..... | 59 |
| Preheating the oven..... | 60 |
| Booster..... | 60 |
| Preheat..... | 61 |
| Crisp function..... | 62 |
| Changing the operating mode..... | 62 |
| Settings | 63 |
| Settings overview..... | 63 |
| Opening the “Settings” menu..... | 66 |
| Language  | 66 |
| Time..... | 66 |
| Date..... | 67 |
| Lighting..... | 67 |
| Start screen..... | 67 |
| Display..... | 67 |
| Volume..... | 68 |
| Units of Measurement..... | 68 |
| Quick Microwave..... | 68 |
| Popcorn..... | 68 |
| Booster..... | 69 |
| Recommended temperatures..... | 69 |
| Recommended power levels..... | 69 |

| | |
|--------------------------------------|-----|
| Cooling fan run-on | 70 |
| Proximity sensor (MotionReact) | 70 |
| Safety | 71 |
| Miele@home | 71 |
| Remote Control | 72 |
| Activating MobileStart | 72 |
| SuperVision | 72 |
| RemoteUpdate | 73 |
| Lift-up panel | 74 |
| Electrical version | 74 |
| Calibrate temperature | 74 |
| Software version | 75 |
| Legal information | 75 |
| Showroom Program | 75 |
| Factory default | 75 |
| Operating hours (total) | 75 |
| Alarm + Timer | 76 |
| Using the Alarm function | 76 |
| Using the Timer function | 77 |
| Main and submenus | 78 |
| Microwave operation | 80 |
| How it works | 80 |
| Suitable dishware | 80 |
| Suitable dishware | 81 |
| Unsuitable dishware | 83 |
| Testing dishware | 84 |
| Cover | 85 |
| Quick Microwave | 86 |
| Automatic Programs | 87 |
| Categories | 87 |
| Using automatic programs | 87 |
| Usage notes | 87 |
| Search | 88 |
| Special Modes | 89 |
| Defrost | 90 |
| Dehydrate | 93 |
| Reheat | 94 |
| Warm-up Cookware | 97 |
| Proof | 97 |
| Keep warm | 97 |
| Slow Roasting | 98 |
| Sabbath Program | 101 |
| Cooking | 103 |

Contents

| | |
|---|-----|
| Canning | 105 |
| Frozen food/ready meals | 107 |
| MyMiele | 108 |
| Favorites | 109 |
| Baking | 112 |
| Tips for baking | 112 |
| Notes on the operating modes | 112 |
| Roasting | 114 |
| Tips for roasting | 114 |
| Notes on the operating modes | 115 |
| Probe | 116 |
| Broiling | 118 |
| Tips for broiling | 118 |
| Notes on the operating modes | 119 |
| Cleaning and care of the drawer | 120 |
| Cleaning and care of the oven | 122 |
| Unsuitable cleaning agents | 122 |
| Removing normal soiling | 123 |
| Removing stubborn soiling | 124 |
| Lowering the browning/broiling element | 125 |
| Frequently asked questions | 126 |
| Customer Service | 132 |
| Contact in the event of a fault | 132 |
| Appliance warranty and product registration | 132 |
| Caring for the environment | 133 |
| Declaration of conformity | 134 |
| Copyrights and licenses | 136 |
| Copyrights and licenses for the communication module | 137 |

IMPORTANT SAFETY INSTRUCTIONS

When using the appliance, follow basic safety precautions, including the following:

Read all instructions before installation and use of the oven to prevent accidents and machine damage.

WARNING - To reduce the risk of burns, electric shock, fire, injury to persons, or exposure to excessive microwave energy:

This appliance complies with current safety requirements. Improper use of the appliance can lead to personal injury and material damage.

Read all instructions before installing or using the oven for the first time. Only use the appliance for its intended purpose.

Keep these operating instructions in a safe place and pass them on to any future user.

Read and follow the specific “PRECAUTIONS TO AVOID POSSIBLE EXPOSURE TO EXCESSIVE MICROWAVE ENERGY” found at the beginning of this manual.

Only use the appliance for its intended purpose. Install or locate this appliance only in accordance with the provided installation instructions and all local codes.

When using the Range, please comply with the basic safety requirements, including the following instructions:

Read all instructions before installation and use of the Range to prevent accidents and damage to the appliance.

IMPORTANT SAFETY INSTRUCTIONS

This range complies with current safety requirements. However, improper use of the appliance can result in personal injury or damage to property.

Please read the installation instructions carefully before installing and connecting the appliance.

Read the operating instructions before using the range for the first time. To prevent accidents and damage to the appliance, always observe both the installation instructions and operating instructions. Both documents contain important information about installation, safety, use and maintenance.

Miele cannot be held liable for damage occurring as a result of non-compliance with the instructions.

Keep these installation instructions and operating instructions in a safe place and pass them on to any future owner.

- ▶ For the sake of simplicity, the speed oven will subsequently be referred to as the “oven”.
- ▶ Please note that the Gourmet Warming Drawer is subsequently referred to as the drawer.

IMPORTANT SAFETY INSTRUCTIONS

Appropriate use

- ▶ This range is intended for domestic use and use in other similar environments.
- ▶ This appliance is not intended for outdoor use.
- ▶ Use the range exclusively under normal domestic conditions:
 - Use the oven for baking, roasting, broiling, defrosting, canning and drying food.
 - Use the cooktop to prepare food and keep it warm.

Any other use is not permitted.

- ▶ Risk of Fire! Do not use this oven to store or dry combustible materials.
- ▶ Persons who lack physical, sensory or mental abilities, or experience with the appliance should not use it without supervision or instruction by a responsible person.
- ▶ The oven compartment is equipped with special bulbs to cope with particular conditions (e.g., temperature, moisture, chemical resistance, abrasion resistance, and vibration). These special bulbs must only be used for the purpose for which they are intended. They are not suitable for room lighting. Replacement bulbs should only be installed by a Miele authorized technician or by Miele Customer Service.

IMPORTANT SAFETY INSTRUCTIONS

Safety with children

▶ Activate the system lock to ensure that children cannot switch on the oven inadvertently.

▶ Children should be supervised in the vicinity of the oven. Never allow children to play with the oven.

▶ Risk of burns due to improper use. Do not allow children to operate the range.

▶ Burn Hazard - Do not allow children to use the oven.

▶ Risk of burns due to improper use. Do not allow children to operate the Gourmet Warming Drawer.

▶ Risk of suffocation from packaging material. While playing, children may become entangled in packaging material (such as plastic wrapping) or pull it over their head, presenting the risk of suffocation.

Keep packaging material away from children.

▶ Risk of injury caused by hot surfaces. Children's skin is far more sensitive to high temperatures than that of adults. External parts of the oven such as the door glass, control panel, and the vent become quite hot.

Do not let children touch the oven when it is in operation.

▶ Risk of injury from the open door. The oven door can support a maximum weight of 17.5 lbs (8 kg). Children could injure themselves on an open door.

Do not let children sit on the door, lean against it, or swing on it.

Technical safety

▶ This appliance must be installed and connected in compliance with the installation instructions.

▶ Unauthorized installation, maintenance, and repairs can cause considerable danger for the user. Installation, maintenance, and repairs should only be carried out by a Miele authorized technician.

IMPORTANT SAFETY INSTRUCTIONS

- ▶ Changes or modifications not expressly approved by Miele may void the user's authority to operate the oven.
- ▶ A damaged range can be dangerous. Always check for visible signs of damage. Never use a damaged appliance.
- ▶ Maintenance by the user: Never repair or replace any part of the appliance unless the instructions specifically recommend doing so. Service work should only be performed by a qualified technician.
- ▶ Temporary or permanent operation on an autonomous power supply system or a power supply system that is not synchronized with the grid power supply (e.g., island networks, back-up systems) is possible. A prerequisite for operation is that the power supply system complies with national and local codes.
The function and operation of the protective measures provided in the domestic electrical installation and in this Miele product must also be maintained in isolated operation or in operation that is not synchronized with the grid power supply, or these measures must be replaced by equivalent measures in the installation.
- ▶ Operating a damaged oven can result in microwave leakage and present a hazard to the user. Do not use the oven if:
 - The door is warped.
 - The door hinges are loose.
 - Holes or cracks are visible in the casing, the door, or the oven compartment walls.
- ▶ The electrical safety of the range can only be guaranteed when it is properly grounded. Compliance with this essential safety requirement is absolutely mandatory. If in any doubt, please have the building's wiring system inspected by a qualified electrician.
- ▶ Proper installation: Make sure that your appliance has been installed correctly and that it has been grounded by a qualified technician.

IMPORTANT SAFETY INSTRUCTIONS

- ▶ To avoid damaging the range, make sure that the connection data (voltage and frequency) on the data plate correspond to the building's power supply before connecting the appliance. When in doubt, consult a qualified electrician.
- ▶ Installation and maintenance of the gas connection must be performed by qualified installers, service agencies or gas providers.
- ▶ During installation, maintenance and repair work, e.g. if the oven lighting is broken, the range must be completely disconnected from the power supply (see “Frequently asked questions”). The gas inlet valve must be closed. It is only completely isolated from the supply when:
 - The circuit breakers have been switched off, or
 - the fuses of the electrical installation have been completely removed, or
 - the plug (if present) is removed from the outlet. To do this, pull the plug not the cord.
 - Shut off the gas supply and disconnect the range from the gas supply. Installation and maintenance of the gas connection must be performed by qualified installers, service agencies or gas providers.
- ▶ Do not use a power strip or extension cord to connect the range to electricity. These are a fire hazard and do not guarantee the required level of appliance safety.
- ▶ For safety reasons, only use the range when it has been fully installed.
- ▶ This range must not be installed and operated in non-stationary installations (e.g., on a ship).
- ▶ Risk of injury due to electric shock. Any contact with live connections or tampering with the electrical or mechanical components of the range will endanger your safety and may lead to appliance malfunctions.
Do not open the range housing under any circumstances.
- ▶ Any repairs not performed by a Miele authorized service technician will void the warranty.

IMPORTANT SAFETY INSTRUCTIONS

- ▶ Miele can only guarantee the safety of the appliance when original Miele parts are used. Faulty components must only be replaced with genuine Miele parts.
- ▶ If the power cord is damaged, it must be replaced with a special power cord by a Miele authorized technician (see “Installation – Electrical connection”).
- ▶ The range requires a sufficient supply of cool air for efficient operation. Make sure that the supply of cool air is not hindered in any way (e.g., by installing heat insulation strips in the cabinet niche). In addition, the required supply of cool air must not be excessively heated by other heat sources.

Correct use

- ▶ **Caution:** Heating elements may be hot even though they are not glowing. Interior surfaces of an oven become hot enough to cause burns. External parts of the oven such as the door glass, vents, and the control panel can become hot. During and after use, do not touch, or let clothing or other flammable materials come into contact with heating elements or interior surfaces of the oven until they have had sufficient time to cool.
- ▶ Do not let food sit in the oven for an extended period of time before or after cooking. Doing so can result in food poisoning or sickness.
- ▶ Loose fitting or hanging garments present a fire hazard. Wear proper apparel while operating the appliance.
- ▶ Use only dry, heat-resistant potholders. Moist or damp potholders used on hot surfaces may result in steam burns. Do not let potholders come in contact with oil or grease. Do not substitute dish towels or other bulky items for potholders. Do not let potholders touch hot heating elements.
- ▶ Open the door carefully to allow hot air or steam to escape before placing or removing food.

IMPORTANT SAFETY INSTRUCTIONS

- ▶ To prevent burns, always place oven racks at their desired height while the oven is cool. If the rack must be moved while the oven is hot, do not let pot holders touch hot heating elements.
- ▶ To prevent burns, allow the heating elements to cool before cleaning by hand.
- ▶ Smother the fire or flames, or use a dry chemical extinguishing agent or foam fire extinguisher.
- ▶ Never store flammable liquids and materials in, above or under an oven, or near cooking surfaces.

WARNING

NEVER use this appliance as a space heater to heat or warm the room. Doing so may result in carbon monoxide poisoning and overheating of the oven.

WARNING



NEVER use this appliance as storage space. Doing so may result in carbon monoxide poisoning and overheating of the oven.

WARNING

NEVER cover any slots, holes or openings in the oven bottom or cover an entire rack with materials such as aluminum foil. Doing so blocks air flow through the oven and may cause carbon monoxide poisoning. Aluminum foil linings may also trap heat, causing a fire hazard.

- ▶ Do not obstruct the flow of combustion and ventilation air.
- ▶ This oven must only be used for cooking food. Corrosive chemicals and vapors as well as fumes, vapors or heat given off by glues, plastics or flammable liquids and materials could be hazardous. Do not use it as a dryer, kiln, dehumidifier, etc.
- ▶ Do not let metal objects (aluminum foil, pans) come in contact with the heating element.

IMPORTANT SAFETY INSTRUCTIONS

- ▶ Make certain that the power cords of small appliances do not come in contact with or get caught in the oven door.
- ▶ Risk of injury caused by hot surfaces. The oven gets hot during operation. You could burn yourself on the heating elements, oven compartment, accessories, or food. When the oven is hot, use pot holders to insert, remove, or turn food, as well as when adjusting the oven shelves, etc.
- ▶ To avoid fueling any flames, do not open the oven door if smoke appears inside the appliance. Interrupt the process by turning the appliance off and disconnecting it from the power. Do not open the door until the smoke has dissipated.
- ▶ Due to the high temperatures radiated, objects left near the oven could catch fire. Do not use the oven to heat up the room.
- ▶ Oils and fats are a fire hazard if allowed to overheat. Never leave the oven unattended when cooking with oil or fats. Never attempt to put out oil or fat fires with water. Turn the oven off and extinguish the flames by leaving the door closed.
- ▶ Broiling food for excessively long cooking durations can cause it to dry out with the risk of catching fire. Do not exceed the recommended cooking durations.
- ▶ Please be aware that durations when using microwave power are often considerably shorter when cooking, reheating, and defrosting than when using operating modes without microwave power. Excessively long cooking durations can lead to food drying out and burning, or could even cause it to catch fire. Do not exceed recommended broiling durations when using broiling operating modes. Do not use the Microwave  operating mode to dry flowers or herbs, or to crisp up bread or rolls. Never use a broiling operating mode to dry flowers, herbs, or similar. Use the Convection Bake/Convection Roast  or Surround  operating mode and always ensure this type of procedure is supervised.
- ▶ If using alcohol in your recipes, please be aware that high temperatures can cause the alcohol to evaporate. The vapor can catch fire on hot heating elements.

IMPORTANT SAFETY INSTRUCTIONS

▶ Plastic or aluminum foil cookware melts at high temperatures and can damage the range or start to burn. Do not use any plastic or aluminum foil cookware.

Exception: You can use oven-safe plastic cookware in the oven. Heed the cookware manufacturer's instructions.

▶ When using residual heat to keep food warm, corrosion from high air humidity and condensation can occur in the oven. This can cause damage to the control panel, countertop, and cabinet carcass. Keep the oven on and select the lowest temperature available for the selected operating mode. The cooling fan will then continue to run automatically.

▶ Food which is stored in the oven compartment or left in it to be kept warm can dry out and the moisture released can lead to corrosion damage in the oven. Always cover food that is left in the oven to keep warm.

▶ A buildup of heat can cause damage to the oven.

Never line the floor of the oven with aluminum foil or oven liners.

If you wish to place dishware on the floor of the oven during the cooking process, or place dishware on the floor of the oven to heat it up, you can do so, but only with the Convection Bake/Convection Roast  operating mode, without the Booster function.

▶ The oven floor can become damaged by items being pushed around on it. When placing pots, pans, or dishware on the oven floor, do not push them around.



▶ Risk of injury caused by steam. Pouring a cold liquid onto a hot surface creates steam, which can cause severe scalding. The sudden temperature change can also cause damage to hot surfaces. Never pour cold liquids directly onto hot enameled surfaces.

▶ The oven is not suitable for cleaning or disinfecting items. Items can get extremely hot. There is a risk of burning when items are removed from the oven.

IMPORTANT SAFETY INSTRUCTIONS

- ▶ It is important that the temperature in the food being cooked is evenly distributed and sufficiently high. You can ensure this by stirring or turning the food, and observing a sufficiently long standing time (see charts), which should be added to the time needed for reheating, defrosting, or cooking. During the standing time, the temperature is distributed evenly in the food.
- ▶ When heating food, and in particular liquids, using the Microwave  operating mode, the boiling point may be reached without the typical bubbles being produced. The liquid does not boil evenly throughout. This boiling delay can result in the liquid boiling over explosively. Take care when taking the container out of the oven, as the hot liquid can cause severe scalding. Under certain circumstances, the pressure can be so high that the door opens automatically. Stir liquids well before heating or cooking. After heating, wait at least 20 seconds before removing the container from the oven. In addition, you can place a glass rod or similar item, if available, in the container during the heating process.
- ▶ Risk of injury caused by hot food. When you heat food up, the heat is created directly in the food itself. For this reason, the dishware will remain cooler than the food (except when you use ovenproof stoneware). The dishware is only warmed by the heat of the food. Before serving, always check the temperature of the actual food itself after taking it out of the oven. The temperature of the container is not an indication of the temperature of the food or liquid in it. **This is particularly important when preparing food for babies, children, and the elderly or infirm.** After heating food, especially food for babies and small children, stir the food or shake the container and check that the temperature does not pose any danger of burning. Double check after it has been left to stand.

IMPORTANT SAFETY INSTRUCTIONS

- ▶ Risk of injury from increased pressure in sealed containers or bottles. Pressure can build up when reheating food or drinks in sealed containers or bottles, which can cause them to explode. Never cook or reheat food or liquids in sealed containers or bottles. Open containers beforehand and with baby bottles, the screw top and nipple must be removed.
- ▶ If you cook eggs without their shells, the yolks could explode due to the resulting pressure. Prick the yolk several times before cooking to avoid this.
- ▶ Eggs heated in their shell can burst, even after they have been removed from the oven. Eggs can only be cooked in their shells in a specially designed egg-boiling device. Do not reheat hard-boiled eggs using the Microwave  operating mode.
- ▶ Food with a thick skin or peel, such as tomatoes, sausage, potatoes, and eggplant can burst when heated or cooked. Pierce or score the skin of these foods several times to allow steam to escape.
- ▶ Do not use a thermometer containing mercury or liquid as these are not suitable for use with very high temperatures and break very easily. Only use the Miele probe supplied with the appliance to measure the temperature of the food.
- ▶ Cushions or pads filled with cherry kernels, gel, etc., such as those used in aromatherapy, can ignite when heated, even after they have been removed from the oven. Do not heat these up in the oven.
- ▶ Moisture can collect in the hollow spaces on dishware and lids with hollow handles or knobs. When the moisture evaporates, pressure can build up and the item can explode. If the hollow recess is sufficiently ventilated, the item can be used. Do not use dishware with hollow knobs or handles when using the Microwave  operating mode.

IMPORTANT SAFETY INSTRUCTIONS

▶ Non-microwave-safe plastic dishes can suffer damage or damage the oven if used with the Microwave  operating mode and microwave operating modes.

Do not use any containers or cutlery made from or containing metal, aluminum foil, lead crystal glassware, temperature-sensitive plastics, wooden utensils or cutlery, metal clips, or plastic or paper-covered wire ties. Do not use bowls with milled rims, or plastic pots with the foil lid only partially removed (see the requirements specified for dishware in the section on microwave operation).

▶ Plastic containers which are not heat-resistant melt and may ignite at high temperatures and can damage the oven.

Use only plastic containers that are suitable for use in an oven when using operating modes that do not use microwave power. Follow the manufacturer's instructions.

▶ Fire hazard due to containers made of flammable materials.

Plastic disposable containers must meet the requirements specified for dishware in the section on microwave operation.



Do not leave the oven unattended when heating or cooking food in disposable containers made of plastic, paper, or other flammable materials.

▶ Heat-retaining bags usually contain a thin layer of aluminum foil that reflects microwave radiation. As a result, the paper surrounding the aluminum foil can become so hot that it combusts.

Do not use heat-retaining packaging, such as bags for roasted chicken, for warming food with operating modes that use microwave power.

▶ If the oven is used without food or the food is loaded incorrectly when using the Microwave  operating mode or operating modes that use microwave power, the oven can become damaged.

Do not use any operating modes that use microwave power to preheat dishware or to dry herbs.

Instead, use the Convection Bake/Convection Roast  or Surround  operating modes.

IMPORTANT SAFETY INSTRUCTIONS

▶ Canning food and heating it up in closed containers results in an increase in pressure which can cause them to explode. Do not use cans for canning or reheating food.

▶ Risk of injury from the open door. You could bang into the open door or trip over it. Do not leave the door open unnecessarily.

▶ The door can support a maximum load of 17.5 lbs (8 kg). Do not lean or sit on an open door, or place heavy items on it. Make sure that nothing gets trapped between the door and the oven compartment. This could damage the oven.

▶ Fire hazard.

Do not store any plastic containers or combustible objects in the warming drawer. They can melt or catch fire when the appliance is switched on.

▶ Never use paper towels or other similar objects in place of the non-slip mat supplied with the appliance.

▶ The maximum load capacity of the telescopic drawer rails is 55 lbs (25 kg). If you overload the warming drawer or lean/stand on the drawer when it is open, you will damage the rails.

▶ The underside of the warming drawer gets hot when the appliance is in use. Be careful not to touch it when the drawer is open.

▶ Liquids that get inside the warming drawer can cause the appliance to short-circuit. Open and close a loaded drawer carefully to prevent liquids from spilling.

▶ In some foods, bacterial growth may occur if the temperature is too low. Set the appliance to an adequate warming temperature.

▶ The non-slip mat is heat-resistant up to 395°F (200°C).

It is possible for the bottom of cookware to exceed this temperature, especially after it has been used to sear food. Allow the cookware to cool down for a minute or two before placing it in the warming drawer.

▶ Keeping Warm mode  is to be used for keeping hot dishes warm, not for heating up cold food. Make sure that any food placed in the drawer is at a high enough temperature.

IMPORTANT SAFETY INSTRUCTIONS

The following applies to stainless steel surfaces:

- ▶ Adhesives will damage the coated stainless steel surface and cause it to lose its dirt-repellent protective coating. Do not use sticky notes, adhesive tape, or other types of adhesive on the stainless steel surface.
- ▶ Magnets can cause scratches. Do not use the stainless steel surface as a magnetic notice board.

Cleaning and care

- ▶ Only clean parts listed in these operating and installation instructions.
 - ▶ Risk of injury due to electric shock. The steam from a steam cleaning appliance could reach live electrical components and cause a short circuit. Never use a steam cleaner for cleaning.
 - ▶ Scratches on the door glass can cause the glass to break. Do not use abrasive cleaners, hard sponges, brushes, or sharp metal tools to clean the door glass.
 - ▶ Try to prevent the interior walls being splashed with food containing salt. If this does happen, wipe it away thoroughly to avoid corrosion to stainless steel surfaces inside the oven compartment.
 - ▶ In warm, moist environments, there is a higher probability of pest infestations. Ensure the oven and the area surrounding it are always kept clean.
- Damage caused by pests is not covered by the warranty.

Accessories

- ▶ Only use original Miele accessories. Using parts or accessories from other manufacturers will invalidate the warranty, and Miele cannot accept liability.
- ▶ Only use the Miele probe supplied with the appliance. If it is faulty, it must be replaced with a new original Miele probe.

IMPORTANT SAFETY INSTRUCTIONS

- ▶ The plastic on the probe can melt at very high temperatures. Do not use the probe when using the broiling operating modes. Do not store the probe in the oven compartment when it is not being used.
- ▶ Do not clean the non-slip mat from the Gourmet Warming Drawer in the dishwasher or washing machine. Never place it in the oven to dry!

KEEP THE OPERATING AND INSTALLATION INSTRUCTIONS IN A SAFE PLACE AND REVIEW THEM PERIODICALLY.

Relevant operating and installation instructions

These operating instructions describe the **gourmet warming drawer** and the **speed oven**.

Please also read the separate operating instructions describing the gas cooktop and the oven, as well as the installation instructions for the range.

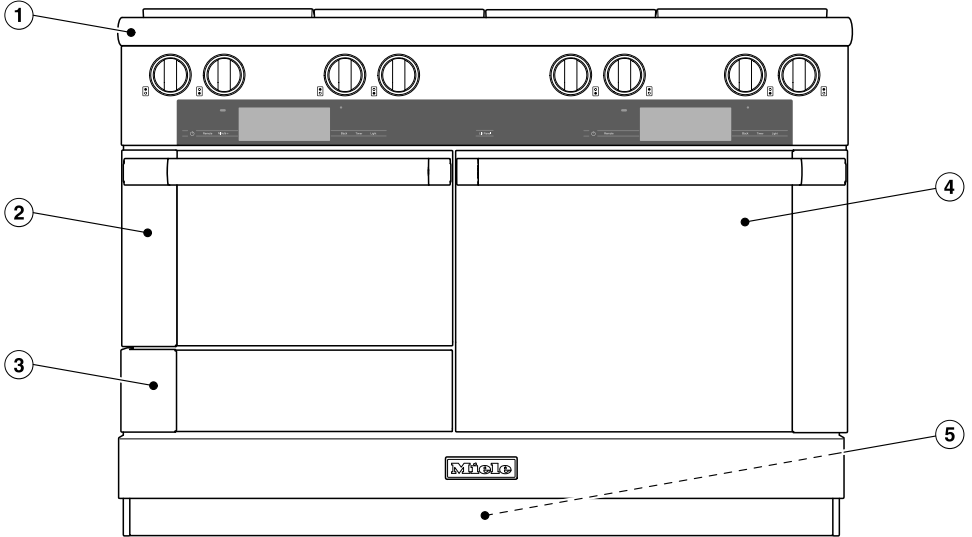

This figure shows the HR 1954-3 Range.

- ① Gas cooktop with knobs for the various burners, depending on the model:
HR 1954-3 with 8 burners: power burners and extra large burners
HR 1955-3 with 6 burners: power burners, extra large burners, and grates
HR 1956-3 with 6 burners: power burners, extra large burners, and griddle plate
- ② Speed oven
Control elements for the speed oven on the left-hand side
- ③ Gourmet warming drawer
The drawer can be opened and closed by pressing lightly on the drawer front.
- ④ Oven
Control elements for the oven on the right-hand side
- ⑤ Data plate
The Range data plate is located behind the toe-kick panel.
Additional data plates for connecting the individual components to the WiFi are located on the:
 - Front frame of the oven and speed oven
 - In the drawer

Guide to the range

Guide to the HR 195x-3 Gourmet warming drawer

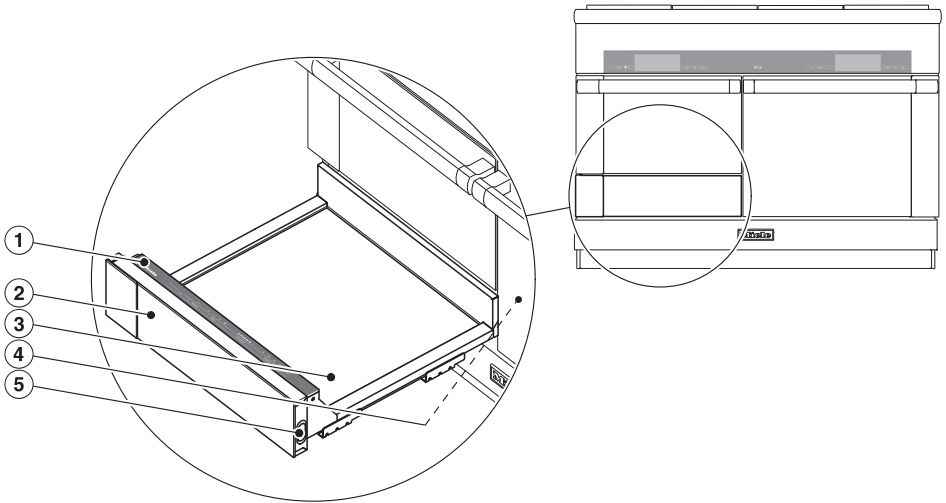

- ① Controls and indicators
- ② Drawer front
Open and close the drawer by pressing lightly on the drawer front (Push2open).
- ③ Non-slip liner
- ④ Extra data plate
For connecting the drawer to your WiFi
- ⑤ Wireless precision probe
You should only use the wireless precision probe in the **oven**; it is not designed for use in the speed oven.

Guide to the HR 195x-3 speed oven

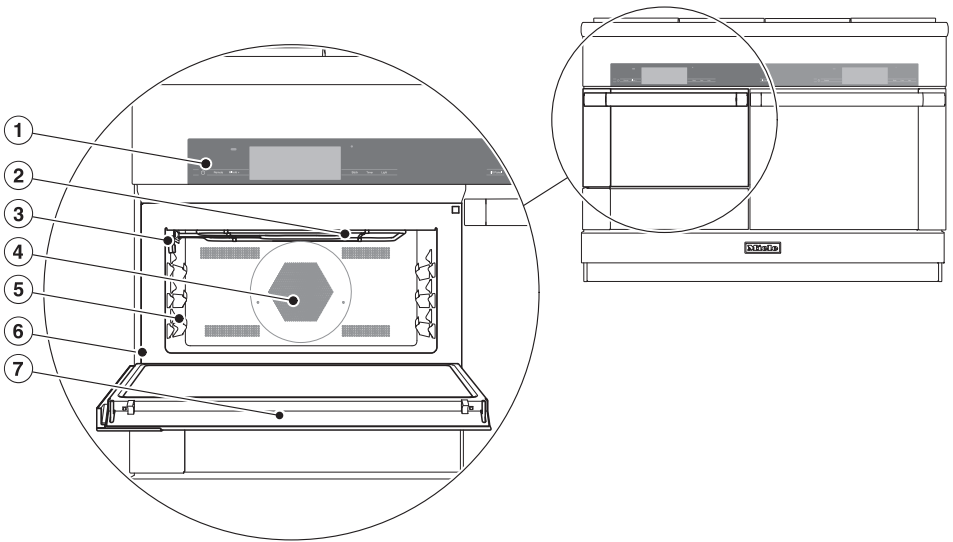

- ① Controls
- ② Browning/Broiling element
- ③ Connection socket for the wired food probe
- ④ Convection fan with heating element
- ⑤ 3 shelf levels for the glass tray and wire rack
- ⑥ Extra data plate
For connecting the oven to your WiFi
- ⑦ Door

Control panel

Control elements for the Gourmet Warming Drawer

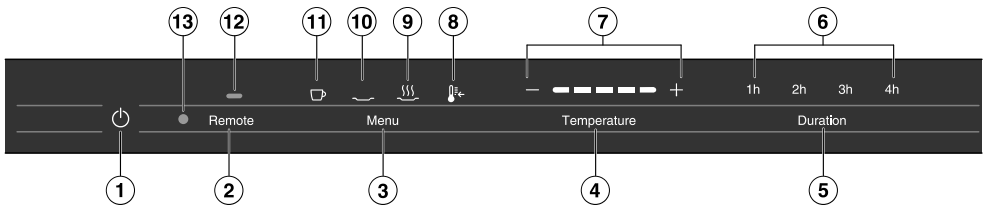

- ① **On/Off button**
For switching the drawer on and off
- ② **Remote sensor button**
For controlling the drawer via your mobile device
- ③ **Menu sensor button**
For selecting the operating mode
- ④ **Temperature sensor button**
For setting the temperature
- ⑤ **Duration sensor button**
For setting a specific duration or reverting to continuous operation.
- ⑥ **Indicators for the selected duration**
1 h = 1 hour
2 h = 2 hours
3 h = 3 hours
4 h = 4 hours
No display = Continuous operation
- ⑦ **Temperature display segment bar**
- ⑧ **Low Temperature operating mode**
- ⑨ **Keep Warm operating mode**
- ⑩ **Warm Dishes/Plates operating mode**
- ⑪ **Warm Cups/Glasses operating mode**
- ⑫ **Remote display**
- ⑬ **Optical interface**
(for Miele Service only)

Control elements for the speed oven

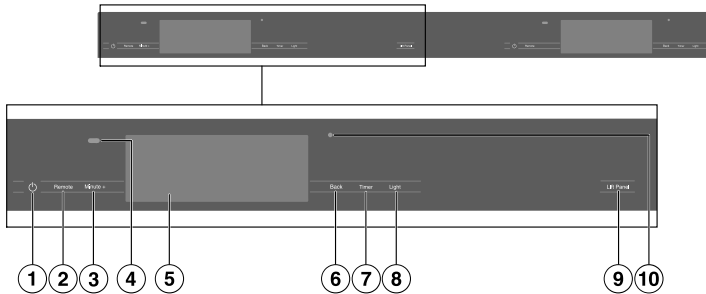

- ① Recessed  On/Off button
For turning the oven on and off
- ② *Remote* sensor button
For controlling the oven via your mobile device
- ③ *Minute +* sensor button
For starting the Quick MW function
- ④ Proximity sensor (MotionReact)
For turning on the oven interior lighting and the display when approached, and to dismiss the audible signal when movement is detected
- ⑤ Touch display
For displaying information and for operation
- ⑥ *Back* sensor button
To go back a step
- ⑦ *Timer* sensor button
To activate or deactivate timers or alarms
- ⑧ *Light* sensor button
For switching the oven interior lighting on and off
- ⑨ *Lift Panel* sensor button
For raising and lowering the control panel
- ⑩ Optical interface
(for Miele Service only)

Control panel

On/Off button

The  On/Off button is recessed and reacts to touch.

Use this button to turn the oven on and off.

Proximity sensor (MotionReact)

The proximity sensor is located under the touch display next to the *Back* sensor button. The proximity sensor detects when you approach the touch display, e.g., with your hand or body.

If you have activated the corresponding settings, you can turn on the oven interior lighting, turn on the oven, or acknowledge the audible signals (see “Settings – Proximity sensor (MotionReact)”).

Sensor buttons

The sensor buttons react to touch. Every tap of a sensor button is confirmed with an audible keypad tone. You can turn this keypad tone off by selecting the [Volume | Keypad Tone | Off](#) setting.

If you want the sensor buttons to respond even when the oven is turned off, select the [Display | QuickTouch | On](#) setting.

| Sensor button | Function |
|-------------------|--|
| <i>Remote</i> | <p>If you want to control the oven from your mobile device, you must have the Miele@home system, turn on the Remote Control setting, and tap this sensor button. The sensor button then lights up and the MobileStart function is available.</p> <p>As long as this sensor button is illuminated, you can control the oven via your mobile device (see “Settings – Miele@home”).</p> |
| <i>Minute +</i> | <p>Use this sensor button to start the Quick Microwave function. The cooking process runs with the maximum power level (level 7) and a cooking duration of 1 minute (see section “Quick Microwave”). Touching the sensor button repeatedly increases the cooking duration in increments.</p> <p>This function can only be used when no other cooking processes are in use.</p> |
| <i>Back</i> | <p>Depending on which menu you are in, this will take you back a level or back to the main menu.</p> |
| <i>Timer</i> | <p>If a menu appears on the display or if a cooking process is in progress, you can use this sensor button to set a timer (e.g., when boiling eggs) or an alarm (a specific time) at any point (see “Alarm + timer”).</p> |
| <i>Light</i> | <p>Select this sensor button to turn the oven interior lighting on and off.</p> <p>Depending on the setting selected, the oven interior lighting turns off after 15 seconds or remains constantly turned on or off.</p> |
| <i>Lift Panel</i> | <p>You can lift up and put down the control panel for the range automatically or manually (see “Settings – Lift-up panel”).</p> <p>The control panel closes automatically as soon as a Self Clean program is started.</p> |

Control panel

Touch display

The sensitive surface of the touch display can be scratched by pointed or sharp objects, e.g., pens.

Only touch the display with your fingers.

Make sure that water cannot get behind the touch display.

The touch display is split into multiple areas.

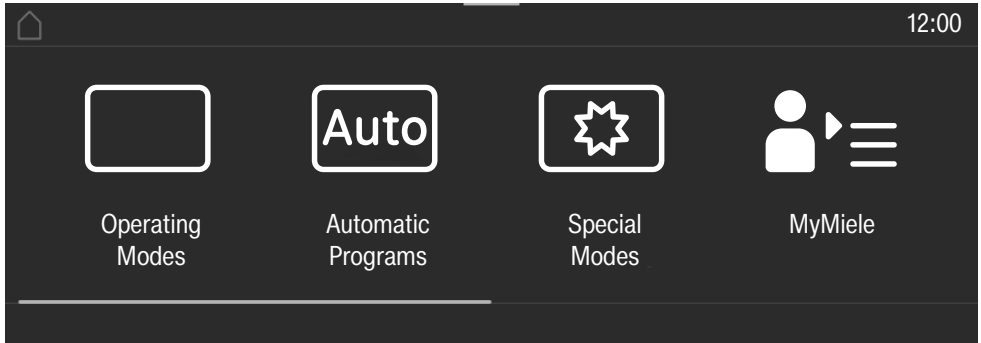

The menu path appears on the left of the **header**. The individual menu options are separated by a vertical line. ... I indicates that there are more menu options available if the menu path can no longer be displayed because there is not enough space on the display.

If you tap a menu name in the header, the display will switch to that menu. To switch to the start screen, tap .

The time of day is shown on the right of the header. You can set the time of day by tapping the display.

Additional symbols may also appear, e.g., SuperVision .

At the top of the header, there is an orange line where you can drag down the pull-down menu. This allows you to turn settings on or off during a cooking process.

The current menu and menu options are shown in the **center** of the display. You can scroll to the right or left by swiping your finger across the display to the right or left. Tap a menu option to select it (see “Using the appliance”).

The operation fields that appear in the **footer** vary according to the menu that is selected; e.g., Timer, Save or OK.

Symbols

The following symbols may appear on the display:

| Symbol | Meaning |
|--------|---|
| | This symbol indicates that there is additional information and advice about using the appliance. Select <i>OK</i> to confirm the information. |
| | This indicates that there are more menu options available, which are not visible because there is not enough space on the display. |
| | Alarm |
| | Timer |
| | Some settings, e.g., display brightness and signal tone volume, are selected using a segment bar. |
| | The system lock or sensor lock is on (see “Settings – Safety”). The controls are locked. |
| | Core temperature when using the probe |
| | Remote control (only appears if you are in the Miele@home system and have selected the Remote Control On setting) |
| | SuperVision (only appears if you are in the Miele@home system and have selected the SuperVision SuperVision display On setting) |

Using the appliance

You operate the oven via the touch display by tapping the menu option you want.

Each time you tap a possible option, the relevant characters (word and/or symbol) will light up **orange**.

Fields for confirming an operating step are highlighted in **green** (e.g., *OK*).

Selecting a menu option

- Tap the field or value you want on the display.

Scrolling

You can scroll left or right.

- Swipe across the screen. To do this, place your finger on the touch display and swipe it in the desired direction.

The bar at the bottom shows you where you are in the current menu.

Exiting a menu

- Tap the *Back* sensor button or tap the ... I symbol in the menu path.
- Tap the  symbol to switch to the start screen.

Entries made before this which have not been confirmed with *OK* will not be saved.

Changing a value or setting

Changing a setting in a list

The current setting is highlighted in orange.

- Tap the desired setting.

The setting is now saved. This will take you back to the previous menu.

Entering numbers with the roller

- Swipe the roller up or down until the desired value is displayed in the center.
- Confirm with *OK*.

The changed number is now saved.

Entering numbers using the numerical keypad

- Tap on the value that is in the middle of the numerical keypad.

The numerical keypad appears.

- Tap the required numbers.

As soon as you enter a valid value, *OK* will turn green.

Use the arrow to delete the last entered number.

- Confirm with *OK*.

The changed number is now saved.

Changing the setting with a segment bar

Some settings are represented by a  bar made up of segments. If all of the segments are illuminated, the maximum value is selected.

If none of the segments are illuminated or if only one is, the minimum value is selected or the setting is turned off altogether (e.g., audible signals).

- Tap the corresponding segment on the segment bar to change the setting.
- Select *On* or *Off* to turn the setting on or off.
- Confirm your selection with *OK*.

The setting is now saved. This will take you back to the previous menu.

Entering letters

Letters are entered using a display keyboard. It is best to select short names.

- Tap the letters or characters you want.

Tip: You can add a line break for longer program names using the \lrcorner symbol.

- Tap **Save**.

The name is now saved.

Displaying the context menu

In some menus you can display a context menu, e.g., to rename Favorites or to move entries under *MyMiele*.

- For example, tap a Favorite and keep your finger on it until the context menu opens.
- To close the context menu, tap an area of the display located outside of the menu window.

Moving entries

You can change the order of Favorites or entries under *MyMiele*.

- For example, tap a Favorite and keep your finger on it until the context menu opens.
- Select **Move**.
- Keep your finger on the highlighted field and drag it to the location you want.

Displaying the pull-down menu

During a cooking program, you can turn settings such as **Booster** or **Preheat** and the WiFi function on or off.

- Use the orange line under the header to drag the pull-down menu down.
- Select the setting you want to change.
Active settings are highlighted in orange. Depending on the selected color scheme, inactive settings are highlighted either in black or white (see “Settings – Display”).
- To close the pull-down menu, drag it back up to the top or tap an area of the display located outside of the menu window.

Displaying Help

Context-sensitive help is available for certain functions. In this case, **Help** appears in the bottom line.

- Tap **Help** to display information in text and pictures.
- Tap **Close** to return to the previous menu.

Activating MobileStart

- Select the *Remote* sensor button to activate MobileStart.

The *Remote* sensor button lights up. You can operate your oven remotely with the Miele app.

Directly operating on the oven takes priority over operating it via the remote control function on the app.

You can use MobileStart as long as the *Remote* sensor button is lit up.

Features

A list of the models described in these operating and installation instructions can be found on the back page.

Data plate

The data plate is located behind the toe kick panel. The toe kick panel is attached to the toe kick of the Range by magnets so it can be removed and put back again easily.

There you can find the model number, serial number and the connection data (voltage/frequency/maximum rated load) for your Range.

Have this information available if you need to contact Miele so that any issues can be rectified as quickly as possible.

Extra data plates

The extra data plates for connecting the single appliances to your WiFi are located:

- on the front frame of oven and speed oven
- inside the drawer

Scope of delivery

- Installation instructions for the range
- Operating instructions for the range, speed oven and gourmet warming drawer functions
- Operating instructions for the range, for using the cooktop and oven functions
- Precision probe
- Screws for securing the oven to the cabinet niche
- Anti-tip device including screws for securing the range
- Various accessories

Standard and optional accessories

Your drawer is equipped with a non-slip liner that ensures that the dishware stands securely.

This oven is supplied with a glass tray, a wire rack, and a food probe.

All the accessories listed as well as the cleaning and care products are designed for Miele Ranges.

These can be ordered from the Miele web store, Miele Customer Service, or from your Miele dealer.

When ordering, please quote the model number of your range and the reference number of the accessories required.

Glass tray

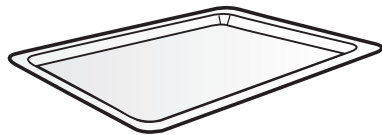



The glass tray is suitable for use with all operating modes.

The glass tray can be damaged by large temperature fluctuations. Do not place the hot glass tray on a cold surface, such as a tiled or granite countertop. Use a suitable mat or pot rest.

- **Always** use the glass tray with the Microwave  operating mode, even if you use it as a shelf for smaller dishes.
- The maximum load for the glass tray is 17.5 lb (8 kg).

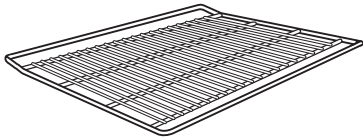
Wire rack with non-tip safety notches



The wire rack is **not** suitable for use with the Microwave  operating mode. You can use the wire rack for all other operating modes which use or do not use microwave power.

 Danger of injury caused by hot surfaces.

The wire rack gets hot during cooking processes.

Use pot holders when placing food in the appliance or removing it and when working in the hot oven cavity.

The oven and wire rack can be damaged by the possible creation of sparks.

Do not use the wire rack for cooking processes with the Microwave  operating mode.

Do not place the wire rack on the oven floor. Place it on one of the shelf levels.

Using the wire rack

The wire rack has non-tip safety notches. These prevent it being pulled right out when it only needs to be pulled out partially.

If you insert the wire rack the wrong way round, the non-tip safety mechanism is not guaranteed.

When pushing the wire rack back in, always ensure that the safety notches are at the **back** of the oven.

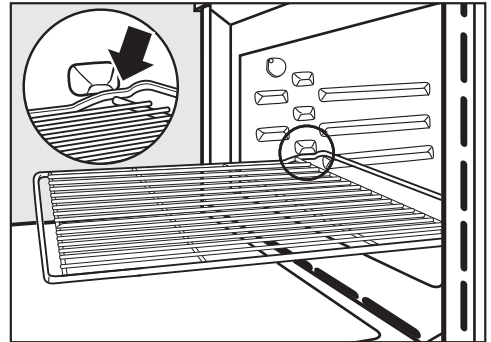

- To remove the wire rack, lift it upwards slightly at the front when the safety notches connect with the sides of the oven.



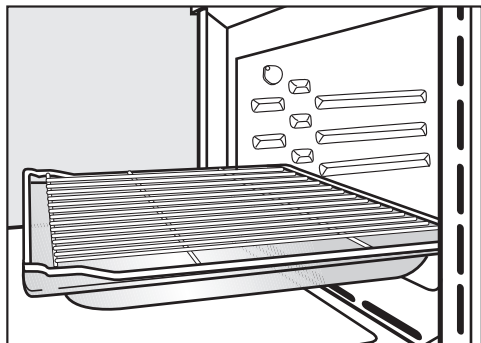

Features



- It is recommended to use the wire rack together with the glass tray when cooking items on the rack which might drip. Only in this case should the safety notches be at the front.
- The maximum load for the wire rack is 17.6 lb (8 kg).

Round baking pans

Round baking trays can suffer damage when subjected to microwaves.

Do not use round baking trays with the Microwave , Combi Auto Roast , Combi Conv Bake/Combi Conv Roast , Combi Broil , or Combi Conv Broil  operating modes.



The **solid round baking pan HBF 27-1** is suitable for cooking pizzas, flat cakes, sweet and savory tarts, baked desserts, flat bread, and can also be used for frozen cakes.

The **round perforated baking and AirFry pan HBFP 27-1** can be used for the same purposes as the **Gourmet baking and AirFry tray, perforated HBBL 71**.

The enameled surface of both bakeware pans has been treated with PerfectClean.

- Insert the wire rack and place the round baking pan on the wire rack.

Probe

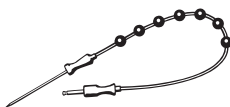

Using the probe enables you to accurately monitor the temperature during the cooking process (see “Roasting – Probe”).

HUB Gourmet Casserole Dishes HBD Gourmet Casserole Dish lids

Gourmet Casserole Dishes and their lids can suffer damage when subjected to microwaves. Metal reflects the microwaves which can create sparks and the microwaves are not absorbed by the metal.

Only use the casserole dishes and their lids for cooking processes with operating modes which **do not use** microwave power.

Insert the wire rack in shelf level 1 and place the Gourmet Casserole Dish on the wire rack.

The surface of the Gourmet Casserole Dishes has a non-stick coating and is suitable for induction cooktops.

Gourmet Casserole Dishes are available in different depths. The width and the height are the same.

Suitable lids are available separately. Please quote the model designation when ordering.

Depth:
8 1/2" (22 cm)

HUB 62-22

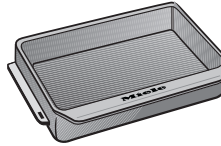

HBD 60-22

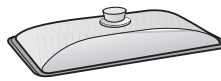

Depth:
13 3/4" (35 cm)*

HUB 62-35

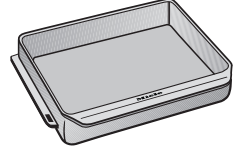

HBD 60-35

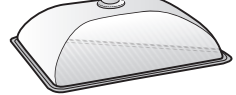

* The casserole dish cannot be used in conjunction with this lid in ovens with 3 shelf levels because the total height would exceed the height of the oven cavity.

Features

Drawer safety features

Safety shut-off

The drawer is set for continuous operation mode (exception: Slow Roasting). The drawer will turn off after a maximum of 12 hours of continuous operation.

Oven safety features

- **System lock** 
(see “Settings – Safety”)
- **Sensor lock**
(see “Settings – Safety”)
- **Cooling fan**
(see “Settings – Cooling fan run-on”)
- **Safety shut-off**
An operating mode which does not use microwave power can be started without selecting a cooking duration. To prevent continuous use and avoid the risk of fire, the oven will switch itself off automatically after a certain time has elapsed following the last operation, depending on the operating mode and temperature selected.

PerfectClean treated surfaces

PerfectClean surfaces have very good non-stick properties making them exceptionally easy to clean.

Food can be easily removed from these surfaces. Soiling from baking and roasting can also be easily removed from these surfaces.

However, do not use ceramic knives as these will scratch the PerfectClean surface.

Read the instructions in “Cleaning and care of the oven” to retain the benefits of the non-stick properties and easy cleaning.

PerfectClean treated surfaces:

- Oven cavity
- Wire rack
- Round baking and AirFry pan, perforated
- Round baking pan

Miele@home

Your range is equipped with an integrated WiFi module. You can add the oven, the speed oven, and the drawer to your WiFi network separately.

To use this feature, you will need:

- a WiFi network
- the Miele app
- a Miele user account You can create a user account via the Miele app.

The Miele app will guide you as you connect your oven/speed oven/drawer to your home WiFi network.

The extra data plates for connecting the single appliances to your WiFi are located:

- on the front frame of oven and speed oven
- inside the drawer

Once each component of your range is connected to your WiFi network, you can use the app to carry out the following activities, for example:

- Call up information on the operating status of each component
- Call up information on cooking processes that are in progress in each component
- Stop cooking programs that are in progress

Connecting the components to your WiFi network will increase energy consumption, even when the range is turned off.

Make sure that the signal of your WiFi network is sufficiently strong in the place where your range is installed.

Availability of the Wi-Fi connection

The Wi-Fi connection shares a frequency range with other appliances (including microwave ovens and remote control toys). This can cause sporadic or even complete connection failures. Therefore, the availability of featured functions cannot be guaranteed.

Miele@home availability

The ability to use the Miele app depends on the availability of the Miele@home service in your country.

The Miele@home service is not available in every country.

For information about availability, please visit www.miele.com.

Miele App

The Miele App is available to download free of charge from the Apple App Store[®] or from the Google Play Store[™].



Before first use

Miele@home for the Gourmet Warming Drawer

There are a number of ways of connecting your drawer to your WiFi network. We recommend connecting your drawer to your WiFi network using the Miele App or via WPS.

To log in you will need:

1. your WiFi network password
2. your drawer password



The password for your drawer consists of the last nine digits of the serial number. This can be found on the appliance's data plate.

Data plate

The data plate for connecting the drawer to your WiFi is located here:

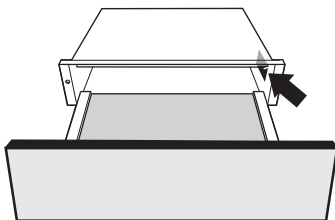

Connecting the drawer via the Miele App

- Start registering the appliance in the Miele App.
- Follow the login steps.

You are then requested to activate the WiFi on the drawer.

- Turn the drawer off.
- Press and hold the *Duration* sensor button.
- At the same time, touch the *Remote* sensor button.

2 h will light up constantly, **3 h** will flash on and off.

The drawer will be ready for connection in the next 10 minutes.

- Follow the instructions in the Miele App.

When successfully connected, **2 h** and **3 h** will light up constantly.

- Touch the *Temperature* sensor button.

You have quit connection mode and can now operate the drawer via the Miele App.

Connecting the drawer via WPS

Your WiFi router must support WPS (WiFi Protected Setup).

- Turn the drawer off.
- Press and hold the *Duration* sensor button.
- At the same time, touch the *Remote* sensor button.

2 h will light up constantly, **3 h** will flash on and off.

The WPS connection must be started on the drawer at the same time as on the WiFi router.

- Touch the *Duration* sensor button after a few seconds.

After a short while, **2 h** will light up constantly, and **3 h** and **4 h** will flash on and off.

The drawer will be ready for connection in the next 10 minutes.

- Start the WiFi connection on your WiFi router.

When successfully connected, **2 h** and **3 h** will light up constantly.

- Touch the *Temperature* sensor button.

You have quit connection mode and can now operate the drawer via the Miele App.

If the connection fails, you have probably not activated WPS on your router quickly enough.

- Repeat the steps above.

Tip: If your WiFi router does not support WPS, please connect the drawer via the Miele App.

Disconnecting the WiFi connection (reset to factory settings)

To set up a new WiFi connection, the existing WiFi connection must be disconnected.

- Turn the drawer off.
- Press and hold the *Temperature* sensor button.
- At the same time, touch the *Remote* sensor button.

With an existing WiFi connection, **2 h** and **3 h** will light up constantly.

The drawer will be ready for disconnection in the next 10 minutes.

- Touch the *Temperature* sensor button.

2 h will light up constantly, **3 h** will flash on and off.

After a few seconds, **2 h** and **3 h** will start flashing on and off. The connection has now been disconnected.

- Touch the *Duration* sensor button.

You have quit disconnection mode.

A new connection can now be set up.



Ensure that all personal data has been removed before disposing of, selling, or operating a used range. Disconnect the drawer from the WiFi connection. This is the only way to ensure that all personal data has been removed and the previous owner will no longer be able to access the drawer.

Before first use

Heating up the drawer for the first time

- Remove any protective film.
- Remove the non-slip liner from the drawer.
- Clean the non-slip liner with hot water and liquid dish soap, applied with a clean sponge cloth or a clean, damp microfiber cloth.
- Dry the non-slip liner with a soft cloth.
- Before heating it up, wipe the drawer inside and out with a damp cloth to remove any dust or left-over packaging.
- Dry all surfaces with a soft cloth.
- Replace the non-slip liner in the drawer.

Heat the drawer for at least two hours.

- Tap the  On/Off button.
- Touch the *Menu* sensor button repeatedly until the  symbol lights up.
- Touch the *Temperature* sensor button repeatedly until the segment on the far right-hand side of the temperature display lights up.
- Touch the *Duration* sensor button repeatedly until **2 h** lights up.
- Close the drawer.

The drawer will switch itself off automatically after two hours.

The drawer is equipped with a contact switch. This ensures that the heating element and fan in the appliance only work when the drawer is closed.

Because the metal components are protected by a conditioning agent, there will be a slight odor the first time the drawer is heated up. The harmless odor will dissipate after a short time and does not indicate a faulty connection or appliance defect.

During this time, make sure that the kitchen is adequately ventilated.

Basic settings for the oven

You must make the following settings before starting up for the first time. You can change these settings again at a later time (see “Settings”).

If the door of the speed oven does not open, it is possible that the range is not correctly aligned.

Check the installation of the range and align it correctly.

 Danger of injury caused by hot surfaces.

The range gets hot during operation.

For safety reasons, only use the range when it has been fully installed.

The range will turn on automatically when it is connected to the power supply.

Setting the language

- Select the desired language.

If you have accidentally selected a language that you don't understand, proceed as described in “Settings – Language ”.

Setting the location

- Select the required location.

Setting up Miele@home

Set up Miele@home? will appear on the display.

- To set up Miele@home immediately, select *Continue*.

- To set it up at a later date, select *Skip*. See “Settings – Miele@home” for information on setting up at a later date.
- To set up Miele@home immediately, select the connection method you want to use.

You will then be guided by the display and the Miele app.

Setting the date

- Set the day, then the month, and finally the year.
- Confirm with *OK*.

Setting the time

- Set the time of day in hours and minutes.
- Confirm with *OK*.

Setting the voltage

 The set voltage variant must match the voltage of the domestic electrical supply in order to avoid the risk of damage to the oven.

Confirm the voltage before setting. If in any doubt, consult a qualified electrician.

- Select the voltage variant.
- Confirm with *OK*.

Completing the commissioning process

- Follow any further instructions on the display.

The appliance is now ready for use.

Before first use



Heating the oven for the first time

New ovens may have a slight odor when they are heated up for the first time. This can be eliminated by heating the empty oven for at least an hour.

Ensure that the kitchen is well ventilated while the appliance is being heated up for the first time. Close doors to other rooms to prevent the odor spreading throughout the house.

- Remove any adhesive labels or protective films from the ovens and accessories.
- Take all accessories out of the oven cavity and clean them (see “Cleaning and care”).
- Before heating the oven up, wipe the interior with a damp cloth to remove any dust or bits of packaging that may have accumulated in the oven cavity.
- Turn the oven on using the  On/Off button.

The main menu will appear.

- Select Operating Modes .
- Select Convection Bake .

350°F (160°C) will appear as a recommended value.

The oven heating, lighting, and cooling fan will turn on.

- Set the highest possible temperature.
- Confirm with *OK*.

Heat up the oven for at least an hour.

- After at least an hour, turn the oven off with the  On/Off button.

Cleaning the oven cavity after heating it up for the first time

 Danger of injury caused by hot surfaces.

The oven gets hot during operation. You could burn yourself on the heater elements and the oven cavity. Allow the heater elements and oven cavity to cool before manual cleaning.

- Clean the oven cavity with warm water and liquid dish soap, applied with a soft sponge or microfiber cloth.
- Dry all surfaces with a soft cloth.

Leave the oven door open until the oven cavity is completely dry.

Opening and closing the drawer

 **Damage caused by liquids.**
Liquids that get inside the drawer can cause a short circuit.
Open and close a loaded drawer carefully to prevent liquids from spilling.

The drawer is equipped with a non-slip liner which prevents dishware from sliding around when the drawer is opened and closed.

- Open or close the drawer by pressing lightly in the middle of the drawer front.

Operating the drawer

Malfunction can occur due to dirty and/or covered sensor buttons. The sensor buttons do not react or unintentional switching procedures result, perhaps even the automatic deactivation of the drawer. Keep the sensor buttons and indicators clean. Do not place anything over the sensor controls or indicators.

The drawer is operated via the sensor buttons and the indicators.

- Tap the  On/Off button.

The last setting selected is automatically activated and displayed the next time the drawer is turned on.

- Touch the *Menu* sensor button repeatedly until the required operating mode lights up.
- Touch the *Temperature* sensor button repeatedly until the segment for the required temperature lights up in the temperature display.

The drawer is set for continuous operation mode (exception: Low Temperature). The safety shut-off will turn off the drawer after a maximum of 12 hours of continuous operation. If you require a shorter operating time you can limit the duration.

- Touch the *Duration* sensor button repeatedly until the required duration lights up.
- If a duration of 4 h is set, touching the sensor button once more will restore continuous operation.

Operating the drawer

Activating MobileStart

If you have installed the Miele App on your mobile device and have access to the Miele@home system, you can use the MobileStart function to retrieve information on drawer cooking processes that are in progress or to end a process in progress.

- Select the *Remote* sensor button to activate MobileStart.

The indicator above the *Remote* sensor button lights up. You can operate your drawer remotely with the Miele App.

Directly operating on the drawer control elements takes priority over operating it via the remote control function on the app. You can use MobileStart as long as the indicator above the sensor button is lit up.

Selecting the operating mode

The following operating modes are available:

- ☐ Warm Cups/Glasses
- — Warm Dishes/Plates
- ≡ Keep Warm
- ⏪ Slow Roasting

 Danger of injury caused by hot dishware. Dishware will take longer to warm up, but can get very hot! You could burn yourself on the hot dishware. Use pot holders when removing hot dishware from the drawer.

The last operating mode selected is automatically activated and displayed the next time the drawer is turned on.

- Touch the *Menu* sensor button repeatedly until the required operating mode lights up.

The appliance is equipped with a fan which distributes the warmed air within the drawer.

The fan runs continuously in the ☐ Warming cups/glasses and — Warming dishware/plates operating modes.

The fan runs at intervals in the ≡ Keeping food warm and ⏪ Slow Roasting operating modes.

The appliance can be used to keep food warm at the same time as warming plates and dishware. Use the ≡ Keeping food warm operating mode for this.

Setting the temperature





Each operating mode has its own temperature range. The factory default recommended temperatures are printed in bold.

The temperature can be altered in 5° increments.

- Touch the *Temperature* sensor button repeatedly until the segment for the required temperature lights up in the temperature display.

The last temperature selected is automatically activated and displayed the next time the drawer is turned on (exception: Low Temperature).

Temperature settings

| Temperature display | Temperature °F (°C)* | | | |
|---------------------|---|---|---|--|
| |  |  |  |  ** |
| ■ □ □ □ □ | 105 (40) | 140 (60) | 150 (65) | 150 (65) |
| □ ■ □ □ □ | 115 (45) | 150 (65) | 160 (70) | 160 (70) |
| □ □ ■ □ □ | 120 (50) | 155 (70) | 170 (75) | 170 (75) |
| □ □ □ ■ □ | 130 (55) | 170 (75) | 175 (80) | 175 (80) |
| □ □ □ □ ■ | 140 (60) | 175 (80) | 185 (85) | 185 (85) |

* Approximate temperatures, measured in the center of an empty drawer

** The core temperature of the food is correspondingly lower

Operating the drawer

Setting the duration

Do not leave the drawer unattended for long periods in continuous operation. Long warming times lead to the food drying out, which may cause it to catch fire.

The drawer is set for continuous operation mode (exception: Low Temperature). The drawer will turn off after a maximum of 12 hours of continuous operation.

A limited duration can be selected by touching the *Duration* sensor button.

- Touch the *Duration* sensor button once to set 1 hour (1 h).
- Touch the *Duration* sensor button twice to set 2 hours (2 h).

Each time you touch the sensor button, you increase the setting by one hour. You can set a maximum duration of 4 hours.

Continuous operation is restored by touching the sensor button a fifth time.

Keeping food warm

 Health risk caused by using too low a temperature.

Bacteria may develop in the food if the temperature used for keeping food warm is too low.

Only use the  Keep Warm operating mode.

This operating mode is for keeping food warm which has just been cooked and is still hot. It is not for reheating food that has gone cold.

Place the hot food in preheated dishware.

- Select the  Keeping food warm operating mode.
- Select the desired duration.
- Preheat the drawer for 15 minutes to ensure that the interior reaches the required temperature. Place the dishware that is used to keep food warm in the drawer while it is being preheated.
- Use pot holders when removing hot dishware from the drawer.
- After 15 minutes, remove the preheated dishware from the drawer and fill it with the hot food.
- Then place the dishware in the drawer and close it carefully to prevent any liquids from spilling.

Tips

To maintain your food's optimum quality please note the following:

- The drawer's non-slip liner is heat-resistant up to 395°F (200°C). It is possible for the bottom of cookware to exceed this temperature, especially after they have been used to sear food. Allow cookware to cool down for a minute or two before placing them in the drawer.
- Place the hot food in preheated dishware. Place the dishware in the drawer while it is being preheated.
- Do not cover roast or fried food which you want to keep crisp. These types of food need to be kept warm at a higher temperature.
- Cover liquids and food with a high moisture content with a suitable lid or heat-resistant foil. This will prevent moisture escaping and condensing outside the dishware.
- To avoid spilling the food, do not overfill the dishware.
- Freshly cooked food is hotter than food which is being kept warm. Serve food which has been kept warm on preheated plates.
- Foods begin to lose their nutrients during the cooking process and continue to do so while being kept warm. The longer food is kept warm, the greater the loss of nutrients.
- We do not recommend food being kept warm for too long, as it will continue to cook.
- Food may cool down if the drawer is opened and closed too often.
- Do not open the drawer too quickly or slam it shut. Liquids could spill over and get into the vents or into the inner parts of the drawer.

Operating the drawer

Recommendations for the Keep Warm operating mode

| Food | Dishware | Cover dishware | Temperature |
|-----------------------------|-------------|----------------|-------------|
| Steak rare | Plates | No | ■ □ □ □ □ |
| Bakes/gratin | Gratin dish | Yes | □ □ □ ■ □ |
| Roasting | Plates | Yes | □ □ ■ □ □ |
| Stew | Pot | Yes | □ □ □ ■ □ |
| Fish strips | Pan | No | □ □ □ □ ■ |
| Meat in a sauce | Pot | Yes | □ □ □ ■ □ |
| Vegetables in sauce | Pot | Yes | □ □ □ ■ □ |
| Goulash | Pot | Yes | □ □ □ ■ □ |
| Mashed potatoes | Pot | Yes | □ □ ■ □ □ |
| Menu | Plates | Yes | □ □ □ ■ □ |
| Baked potatoes/new potatoes | Plate/pot | Yes | □ □ ■ □ □ |
| Breaded cutlets | Pan | No | □ □ □ □ ■ |
| Pancakes | Plates | No | □ □ □ □ ■ |
| Pizza | Plates | No | □ □ □ □ ■ |
| Boiled potatoes | Pot | Yes | □ □ □ ■ □ |
| Sauce | Pot | Yes | □ □ □ ■ □ |
| Strudel | Plates | No | □ □ □ ■ □ |
| Warming bread loaf | – | No | ■ □ □ □ □ |
| Warming rolls | – | No | ■ □ □ □ □ |

Warming dishes

Tips

- Spread the dishware out across the whole surface if possible. Stacks of plates heat up more slowly than individual pieces of dishware. If you cannot avoid stacking plates, place these at the front of the drawer.
- Do not place large serving dishes right up against the vents. They will cover the warm air outlets. The dishware will not heat up evenly.
- For cups and glasses, only select the  Warming cups/glasses operating mode to ensure that the maximum temperature (140°F/60°C) is not exceeded.
- Heated dishware cools down very quickly. For that reason you should not remove it from the drawer until just before you need it.

Warming times

Various factors will affect the warming times:

- material and thickness of the dishware
- load size
- how the load is arranged
- temperature setting

It is therefore not possible to state precise warming times. However, the following information can be used as a guide.

With the  Warming dishware/plates operating mode, it takes approx. 30–35 minutes to evenly heat up dishware for 6 people.

As you use the appliance, you will get to know which settings suit your own needs best.

Operating the drawer

Capacity

⚠ Risk of damage due to overloading.
Overloading the drawer will damage the telescopic runners.
The maximum load bearing capacity of the drawer is **55 lb (25 kg)**.

The capacity will depend to a great extent on the size and weight of your dishware.
The following loading examples are intended to serve as a guide:

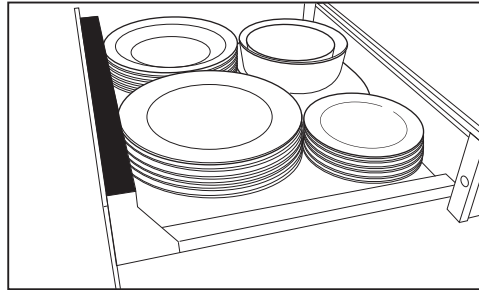

6 place settings

| | |
|--------------------|-------------------|
| 6 dinner plates | Ø 10 1/4" (26 cm) |
| 6 deep soup plates | Ø 9 1/16" (23 cm) |
| 6 dessert plates | Ø 7 1/2" (19 cm) |
| 1 oval platter | 12 5/8" (32 cm) |
| 1 serving bowl | Ø 6 5/16" (16 cm) |
| 1 serving bowl | Ø 5 1/8" (13 cm) |

Or one of the following arrangements:

| | |
|---|---|
| 12 dinner plates | Ø 10 1/4" (26 cm) |
| 18 deep soup plates | Ø 9 1/16" (23 cm) |
| 16 soup bowls | Ø 4" (10 cm) |
| 6 dinner plates and 6 deep soup plates | Ø 10 1/4" (26 cm) Ø 9 1/16" (23 cm) |
| 6 pizza plates | Ø 14 3/16" (36 cm) |
| 72 espresso cups | Ø 2 5/16" (5.9 cm) |
| 30 cappuccino cups | Ø 3 7/16" (8.8 cm) |
| 30 tea glasses | Ø 2 3/4" (6.7 cm) 3 1/4" (8 cm high) |

Other uses

☐ Warm Cups/Glasses operating mode

| Food | Dishware | Cover dishware | Temperature | Duration [h:min] |
|------------------|-----------------------|-----------------|-------------|------------------|
| Proof Dough | Bowl | Yes, with plate | ■ □ □ □ □ | 00:30 |
| Preparing yogurt | Yogurt jars with lids | – | □ ■ □ □ □ | 5:00 |

☺ Keep Warm operating mode

| Food | Dishware | Cover dishware | Temperature | Duration [h:min] |
|------------------------------|------------|----------------|-------------|------------------|
| Defrosting berries | Bowl/plate | No | ■ □ □ □ □ | 00:50 |
| Dissolving gelatin | Bowl | No | □ □ □ □ ■ | 00:15 |
| Soaking rice pudding | Pot | Yes, with lid | □ □ □ □ ■ | 00:40 |
| Melting chocolate | Bowl | No | □ □ □ □ ■ | 00:20 |
| Defrosting frozen vegetables | Bowl | No | □ □ ■ □ □ | 1:00 |

Operating the drawer

Sabbath Program

The Sabbath Program is designed for religious observance.

If you activate the Sabbath Program, the drawer turns off automatically after about 24 or 72 hours, depending on the setting, and normal operation will resume. If the Sabbath Program is activated, the *Duration* sensor button is deactivated. The other sensor buttons need to be pressed for longer than usual.

Activating the Sabbath Program (24 hours)

The drawer must be turned off.

- Press and hold the *Duration* sensor button.
- Touch the ⏻ On/Off sensor button at the same time.

2 h and **4 h** will light up.

- Touch the *Menu* sensor button repeatedly until the required indicator lights up.
- Touch the *Temperature* sensor button repeatedly until the required indicator lights up.

Activating the Sabbath Program (72 hours)

The drawer must be turned off.

- Press and hold the *Duration* sensor button.
- Touch the ⏻ On/Off sensor button at the same time.

2 h and **4 h** will light up.

- Touch the *Duration* sensor button.
- **1 h**, **2 h**, **3 h**, and **4 h** will light up.
- Touch the *Menu* sensor button repeatedly until the required indicator lights up.
- Touch the *Temperature* sensor button repeatedly until the required indicator lights up.

Deactivating the Sabbath Program

You can deactivate the Sabbath Program before the time has expired.

- Press and hold the ⏻ On/Off button.

All displays switch off.

The drawer is in normal mode again.

If you place food directly on the floor of the oven when using the Microwave  operating mode, the oven can become damaged.

When using the Microwave  operating mode, place the glass tray on level 1 and **always** place containers such as cups and baking tins on the glass tray.

- Turn the oven on.

The main menu will appear.

- Place the food in the oven compartment.
- Select Operating Modes .
- Select the operating mode you want to use.

The operating mode will appear in the display. Depending on the operating mode, the recommended power level, recommended temperature, and the cooking duration will appear in the display.

- Change the recommended values for the cooking process and set the cooking duration if required.

You can change the recommended values later by selecting the relevant value or Timer.

- Touch *OK* to start the cooking process for operating modes which **do not use** microwave power.
- Touch *Start* to start the cooking process for operating modes which **use** microwave power.

The set values appear and the cooking process duration counts down in the display for all operating modes.

If you have set a temperature, you will see the temperature increasing. An audible signal will sound when the set temperature is reached for the first time.

The oven stops generating microwave power when you interrupt the cooking process with *Stop* or open the door. You can continue the cooking process with *Start*.

- After the cooking process, select *Finish* or *Close* (depending on the operating mode).
- Take the food out of the oven compartment.
- Turn the oven off.

Changing values and settings for a cooking program

Depending on the operating mode, as soon as a cooking program is in progress, you can change the values or settings for this program.

Depending on the operating mode, you can change the following settings:

- Temperature
- Power Level
- Duration
- Ready at
- Start at
- Booster
- Preheat
- Crisp function

Using the oven

Changing the temperature and core temperature

Via Settings | Recommended temperatures, you can permanently adjust the recommended temperature to suit your cooking preferences.

The  core temperature only appears if you are using the probe (see “Roasting – Probe”).

- Tap the temperature display.
- Change the temperature and the  core temperature as required.
- Confirm with OK.

The cooking program will resume with the new target temperatures.

Changing the microwave power level

You can permanently reset the default power level to suit your cooking preferences by selecting Settings | Recommended power levels.

- The set microwave power level will appear in the display.
- Change the microwave power level.
- Select Start.

The cooking process continues to run with the modified microwave power level.

Setting additional durations

Cooking results can be adversely affected if there is a long delay between the food being placed in the oven and the start of cooking. Fresh food can change color and even spoil.

When baking, the cake mixture or dough can dry out, and the raising agents can lose their effectiveness.

Select as short a time as possible until the start of the cooking process.

You have placed the food in the oven compartment, selected an operating mode and the required settings such as the temperature.

By entering Duration, Ready at or Start at, you can automatically turn the cooking process off or on and off.

- Duration
Enter the required cooking duration for the food. The oven heating will turn off automatically once the cooking duration has elapsed. The maximum cooking duration that can be set depends on the operating mode that you have selected.
- Ready at
Specify when you want the cooking process to finish. The oven will turn off automatically at the time you have set.
- Start at
This function will only appear in the menu if you have set a Duration or Ready at time. With Start at, you have to specify when you want the cooking process to start. The oven will turn on automatically at the time you have set.

- Select  or Timer.
- Set the required times.
- Confirm with *OK*.

Changing set durations

- Select , the duration, or Timer.
- Select the time you want and change it.
- Confirm with *OK*.

These settings will be deleted in the event of a power failure.

Deleting the set cooking durations

- Select , the duration, or Timer.
- Select the time you want.
- Select *Delete*.
- Confirm with *OK*.

If you delete *Duration*, the set durations for *Ready at* and *Start at* are also deleted.

If you delete *Ready at* or *Start at*, the cooking program will start using the cooking duration set.

Interrupting a cooking process in the Microwave operating mode

You can interrupt a cooking process when using the Microwave  operating mode and pause the cooking duration.

While the cooking duration is counting down, *Stop* appears in the bottom right of the display.

- Select *Stop*.

The cooking process is interrupted and the cooking duration is paused.

Start is highlighted in green.

- Select *Start*.

The cooking process resumes and the cooking duration continues to count down.

Canceling a cooking program

If you cancel a cooking program, the oven heating and lighting will turn off. Any cooking durations set will be deleted.

Canceling a cooking program without a set cooking duration

- Select *Finish*.

The main menu will appear.

Canceling a cooking program with a set cooking duration

- Select *Cancel*.

Cancel program? will appear.

- Select *Yes*.

The main menu will appear.



Using the oven

Preheating the oven

The **Booster** function is used to quickly preheat the oven cavity in some operating modes.

The **Preheat** function can be used with any operating mode (except Microwave ) and has to be switched on separately for each cooking process. If you have set a cooking duration, it will only start to count down when the target temperature is reached and you have placed the food in the oven.







The oven cavity only needs to be preheated in a few cases.

- You can place most dishes in the cold oven cavity to make use of the heat produced during the heating-up phase.
- Preheat the oven when cooking the following food with the following operating modes:
 - dark bread dough and beef sirloin joints and fillet with the **Convection Bake/Convection Roast**  and **Surround**  operating modes
 - cakes and pastries with a short cooking duration (approx. 30 minutes or less) as well as delicate items (e.g., sponge) with the **Surround**  operating mode (without the **Booster** function)

Booster

The **Booster** function is used to quickly preheat the oven.

This function is turned on as the factory default setting for the following operating modes (Settings | **Booster** | On):

- **Convection Bake** 
- **Convection Roast** 
- **Surround** 
- **Auto Roast** 
- **Combi Conv Bake** 
- **Combi Conv Roast** 
- **Combi Auto Roast** 

If you set a temperature above 210°F (100°C) and the **Booster** function is turned on, a rapid preheating phase heats the oven compartment to the set temperature. The browning/broiling element and the ring heating element come on together with the fan.

Delicate items (e.g., sponge or cookies) will brown too quickly on the top if the **Booster** function is used.

Turn off the **Booster** function for these items.

Turning Booster on or off for a cooking program

If you have selected the **Booster | On** setting, you can turn the function off separately for a cooking program.

On the other hand, you can also turn on the function separately for a cooking program if you have selected the **Booster | Off** setting.

Example: You have selected an operating mode and the required settings such as the temperature. You want to turn off the **Booster** function for this cooking program.

- Drag down the pull-down menu.

Booster is highlighted in orange.

- Select **Booster**.

Depending on the color scheme, **Booster** is highlighted in either black or white.

- Close the pull-down menu.

The **Booster** function is turned off during the preheating phase. Only the heating elements for the selected operating mode are used to preheat the oven compartment.

Preheat

The oven compartment only needs to be preheated in a few cases.

You can place most dishes in the cold oven compartment to make use of the heat produced during the preheating phase.

If you have set a cooking duration, it will only start to count down when the target temperature is reached and you have placed the food in the oven.

Start the cooking process immediately without delaying the start time.

The **Preheat** function is not available with the **Microwave**  operating mode.

Turning Preheat on

The **Preheat** function can be used with any operating mode and has to be turned on separately for each cooking program.

Example: You have selected an operating mode and the required settings such as the temperature. You want to turn on the **Preheat** function for this cooking program.

- Drag down the pull-down menu.

Depending on the color scheme, **Preheat** is highlighted in either black or white.

- Select **Preheat**.

Preheat is highlighted in orange.

- Close the pull-down menu.

The following message will be displayed with a time: **Place food in oven at .** The oven compartment is heated to the set temperature.

- As soon as you are prompted to do so, place the food in the oven.
- Confirm with **OK**.

Using the oven

Crisp function

It is a good idea to use the Crisp function (moisture reduction) when cooking food which has a moist topping, e.g., quiche, pizza, tray bakes with fresh fruit toppings, or muffins.

Poultry in particular gets a nice crisp skin with this function.

Turning Crisp function on

The Crisp function can be used with any operating mode and has to be turned on separately for each cooking program.

You have selected an operating mode and the required settings such as the temperature.

You want to turn on the Crisp function for this cooking program.

- Drag down the pull-down menu.

Depending on the color scheme, Crisp function is highlighted in either black or white.

- Select Crisp function.

Crisp function is highlighted in orange.

- Close the pull-down menu.

The Crisp function is turned on.

Changing the operating mode





You can change to another operating mode during a cooking program.

- Tap the symbol for the selected operating mode.
- If you have set a cooking duration, confirm the **Cancel program?** message with **Yes**.
- Select the new operating mode.

The new operating mode will appear on the display with its corresponding recommended values.

- Set the values for the cooking program and confirm with **OK**.

Settings overview

| Menu option | Available settings |
|--|--|
| Language  | ... deutsch english ... Location |
| Time | Display On* Off Night dimming Clock type Analog* Digital Clock format 24 h 12 h (am/pm)* Set |
| Date | |
| Lighting | On "On" for 15 seconds* Off |
| Start screen | Main menu* Operating modes Automatic Programs Special Modes Favorites MyMiele |
| Display | Brightness  Color scheme Bright Dark* QuickTouch On Off* |
| Volume | Buzzer Tones  Keypad Tone  Welcome Melody On* Off |
| Units of Measurement | Weight g lb* lb/oz Temperature °C °F* |

* Factory default

Settings

| Menu option | Available settings |
|--------------------------|---|
| Quick Microwave | Power Level Duration |
| Popcorn | Duration |
| Booster | On* Off |
| Recommended temperatures | |
| Recommended power levels | |
| Cooling fan run-on | Time controlled Temperature controlled* |
| MotionReact | Switch the light on during cooking program* always on Off Switch the appliance on On Off* Acknowledge buzzer On* Off |
| Safety | System Lock  On Off* Sensor Lock On Off* |
| Miele@home | Activate Deactivate Connection status Set up again Reset Set up |
| Remote Control | On* Off |
| SuperVision | SuperVision display On Off* Display in standby On* Only if there is a fault Appliance list Display this Appliance Buzzer Tones |
| RemoteUpdate | On* Off |

* Factory default

| Menu option | Available settings |
|-------------------------|--|
| Lift-up panel | Automatic Manual* |
| Electrical version | 208V / 60Hz 220V / 60Hz 240V / 60Hz |
| Calibrate temperature | ■■■■■■■■ |
| Software version | |
| Legal information | Open Source Licenses |
| Showroom Program | Demo Mode On Off* |
| Factory default | Appliance settings Favorites MyMiele Recommended power levels Recommended temperatures |
| Operating hours (total) | |

* Factory default

Settings

Opening the “Settings” menu

In the  Settings menu, you can personalize your oven by adapting the factory default settings to suit your requirements.

From the main menu:



- Select  Settings.
- Select the setting you want.

You can check settings or change them.

You cannot change settings while a cooking process is in progress.

Language

You can set your language and location. After selecting and confirming your choice, the language you have selected will appear on the display.

Tip: If you have accidentally selected a language that you don't understand, select  in the main menu. Follow the  symbol to get back to the Language  submenu.

Time

Display

Select how you want the time of day to show on the display when the oven is turned off:

- On
The time is always visible on the display.
If you also select the Display | QuickTouch | On setting, all sensor buttons will react to touch straight away and the proximity sensor will automatically detect when you approach the display.

If you also select the Display | QuickTouch | Off setting, the oven has to be turned on before it can be used.

- Off
The display appears dark to save energy. The oven has to be turned on before you can use it.
- Night dimming
To save energy, the time only shows on the display between 5:00 a.m. and 11:00 p.m. The display remains dark at all other times.

Clock type

The time of day can be displayed as Analog (with a clock face) or Digital (h:min) format.

With the digital display, the date is also shown.

Clock format

The time of day can be displayed in the 24 or 12-hour format (24 h or 12 h (am/pm)).

Set

Set the hours and the minutes.

Tip: If no cooking program is in progress, tap the time in the header to change it.

If there is a power failure, the current time of day will reappear once the power has been restored. The time of day is saved for approx. 150 hours.

If the oven has been connected to a WiFi network and signed into the Miele app, the time will be synchronized based on the location setting in the Miele app.

Date

Set the date.

When the oven is turned off, the date will only appear on the display if the **Time | Clock type | Digital** setting has been selected.

Lighting

- On
The oven interior lighting is turned on during the entire cooking process.
- "On" for 15 seconds
The oven interior lighting turns off 15 seconds after a cooking process has begun. Press the *Light* sensor button to turn the oven interior lighting on again for 15 seconds.
- Off
The oven interior lighting is turned off. Press the *Light* sensor button to turn the oven interior lighting on for 15 seconds.

Start screen

The oven is set at the factory for the main menu to appear when the oven is turned on. You can change this default setting so that, for instance, the operating modes or MyMiele settings appear on the start screen (see "MyMiele").

This new start screen will then appear when the oven is next turned on.

Select the *Back* sensor button or follow the path in the header to get to the main menu.

Display

Brightness

The display brightness is represented by a segment bar.

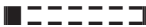
- 
Maximum brightness
- 
Minimum brightness

Color scheme

Choose between a light or dark color scheme for the display.

- Bright
The display has a light background with dark characters.
- Dark
The display has a dark background with light characters.

QuickTouch

Select how the sensor buttons and the proximity sensor should respond when the oven is turned off:

- On
If you have also selected the **Time | Display | On or Night dimming** setting, the sensor buttons and the proximity sensor will also respond when the oven is turned off.
- Off
Regardless of the **Time | Display** setting, the sensor buttons and the proximity sensor only respond when the oven is turned on, as well as for a certain amount of time after turning it off.

Settings

Volume

Buzzer Tones

If audible signals are turned on, an audible signal will sound when the set temperature is reached and at the end of a set time.

The volume of the audible signals is represented by a segment bar.

-  Maximum volume

-  Audible signals are switched off

Keypad Tone

The volume of the tone that sounds each time you tap a sensor button is represented by a segment bar.

-  Maximum volume

-  Keypad tone is turned off

Welcome Melody

The melody that sounds when you tap the  On/Off button can be turned on or off.

Units of Measurement

Weight

For automatic programs, you can set the weight of food in grams (g), pounds (lb), or pounds/ounces (lb/oz).

Temperature

You can set the temperature in Celsius (°C) or Fahrenheit (°F).

Quick Microwave

For an immediate start of the microwave, a microwave power level of 7 and a cooking duration of 1 minute are preset.

- Power Level
You can select a microwave power level from 1 through 7.
- Duration
The maximum cooking duration that can be set depends on the microwave power level selected:
Power level 1 through 3: maximum 10 minutes
Power level 4 through 7: maximum 5 minutes

Popcorn

For an immediate start of the microwave for preparing popcorn, a microwave power level of 6 and a cooking duration of 2:50 minutes are preset. These settings match the manufacturer's instructions on most bags of microwave popcorn.

The maximum cooking duration that can be set is 4 minutes.

The microwave power level is set and cannot be modified.

Booster

The **Booster** function is used to quickly preheat the oven.

- On
The **Booster** function is automatically turned on during the preheating phase of a cooking program. The browning/broiling element, ring heating element, and fan all preheat the oven compartment to the required temperature at the same time.
- Off
The **Booster** function is turned off during the preheating phase of a cooking program. Only the heating elements for the selected operating mode are used to preheat the oven compartment.

You can also use the pull-down menu to turn the **Booster** function on or off for a cooking program.

Recommended temperatures

If you often cook with temperatures that differ from the default, the recommended temperatures can be changed.

After you select this menu option, a list of operating modes will appear on the display.

- Select the operating mode you want to use.

The recommended temperature will appear together with the range within which it can be changed.

- Change the recommended temperature.

- Confirm with **OK**.





Changing the recommended temperature also affects the corresponding operating mode which uses microwave power.

Recommended power levels

If you often cook with microwave power levels that differ from the default, it makes sense to change the default temperatures.

You can change the default power levels for the Microwave  operating mode and for the operating modes which use microwave power.

After selecting this menu option, a list of operating modes will appear in the display together with their default power levels.

- Microwave :
Power levels 1 through 7
- Combi Auto Roast , Combi Conv Bake/Combi Conv Roast , Combi Broil , and Combi Conv Broil :
Power levels 1 through 3
- Select the operating mode you want to use.
- Change the default power levels.
- Confirm with **OK**.

Settings

Cooling fan run-on

The cooling fan will continue to run for a while after the oven has been turned off to prevent any humidity building up in the oven, on the control panel, or in the cabinet carcass.

- Temperature controlled
The cooling fan turns off when the temperature in the oven drops below approx. 160°F (70°C).
- Time controlled
The cooling fan turns off after a period of about 25 minutes.

Condensation can damage the cabinet carcass and the countertop. This could lead to corrosion of the appliance.

When keeping food warm in the oven, increases to the Time controlled setting can lead to condensation in the control panel and moisture on the countertop and cabinet doors.

Do not adjust the Time controlled setting and try not to leave food in the warm oven.

Proximity sensor (MotionReact)

The proximity sensor detects when you approach the touch display, e.g., with your hand or body.

If you want the proximity sensor to respond even when the oven is turned off, select the Display | QuickTouch | On setting.

Switch the light on

- during cooking program
As soon as you approach the touch display during a cooking process, the oven interior lighting turns on. The oven interior lighting automatically turns off again after 15 seconds.
- always on
As soon as you approach the touch display, the oven interior lighting turns on. The oven interior lighting automatically turns off again after 15 seconds.
- Off
The proximity sensor does not respond when you approach the touch display. Press the *Light* sensor button to turn the oven interior lighting on for 15 seconds.

Switch the appliance on

- On
If the time is displayed, the oven will turn on and the main menu will appear as you approach the touch display.
- Off
The proximity sensor does not respond when you approach the touch display. Turn the oven on using the  On/Off button.

Acknowledge buzzer

- On
As soon as you approach the touch display, the audible signals turn off.
- Off
The proximity sensor does not respond when you approach the touch display. Turn the audible signals off manually.

Safety

System Lock

The system lock prevents the oven from being turned on inadvertently.

You can still set an alarm and a timer, as well as use the MobileStart function when the system lock is active.

The system lock will remain activated even after a power failure.

- On
The system lock is now active. If you want to use the oven, touch  for at least 6 seconds.
- Off
The system lock is now deactivated. You can use the oven as normal.

Sensor Lock

The sensor lock prevents the cooking program from being turned off by mistake or settings from being changed. Once activated, the sensor lock prevents the sensor buttons and fields on the display from working for a few seconds after a program has been started, with the exception of the  On/Off button.

- On
The sensor lock is active. Touch *OK* for at least 6 seconds to deactivate the sensor lock for a short period of time.
- Off
The sensor lock is not active. All sensor buttons react to touch as normal.

Miele@home

The oven is a Miele@home-compatible domestic appliance with SuperVision functionality.

Your oven is equipped ex-works with a WiFi communication module and is suitable for wireless communication.

There are a number of ways of connecting your oven to your WiFi network. We recommend connecting your oven to your WiFi network with the help of the Miele app or via WPS.

- Activate
This setting is only visible if Miele@home is deactivated. The WiFi function is reactivated.
- Deactivate
This setting is only visible if Miele@home is activated. Miele@home remains set up; the WiFi function is turned off.
- Connection status
This setting is only visible if Miele@home is activated. The display shows information such as the WiFi reception quality, network name, and IP address.
- Set up again
This setting is only visible if a WiFi network has already been set up. Reset the network settings and set up a new network connection straight away.
- Reset
This setting is only visible if a WiFi network has already been set up. The WiFi function is deactivated and the connection to the WiFi network will be reset to the factory default. You

Settings

must set up a new connection to the WiFi network to be able to use Miele@home.

Reset the network settings if you are disposing of or selling your oven, or if you are putting a used oven into operation. This is the only way to ensure that all personal data has been removed and the previous owner will no longer be able to access the oven.

- Set up
This setting is only visible if no connection to the WiFi network has been set up yet. You must set up a new connection to the WiFi network to be able to use Miele@home.

Remote Control

If you have installed the Miele app on your mobile device, have access to the Miele@home system, and have activated the remote control function (On), you can use the MobileStart function to retrieve information on oven cooking programs that are in progress or to end a program in progress.

Activating MobileStart

- Select the *Remote* sensor button to activate MobileStart.

The *Remote* sensor button lights up. You can operate your oven remotely with the Miele app.

Directly operating on the oven takes priority over operating it via the remote control function on the app.

You can use MobileStart as long as the *Remote* sensor button is lit up.

SuperVision

The oven is a Miele@home-compatible appliance with SuperVision functionality for monitoring other domestic appliances in the Miele@home system.

The SuperVision function cannot be activated until the Miele@home system has been set up.

SuperVision display

- On
The SuperVision function is turned on. The  symbol will appear in the top right-hand corner of the display.
- Off
The SuperVision function is turned off.

Display in standby

The SuperVision function is also available when the oven is in standby. However, the time-of-day display must be turned on (Settings | Time | Display | On).

- On
Active domestic appliances that are signed on to the Miele@home system are always displayed.
- Only if there is a fault
Only faults on active domestic appliances are displayed.

Appliance list

All domestic appliances signed on to the Miele@home System are displayed. Once you have selected an appliance, you can access further settings:

- Display this Appliance
 - On
The SuperVision function for this appliance is turned on.
 - Off
The SuperVision function for this appliance is turned off. The appliance is still signed on to the Miele@home system. Faults are displayed, even if the SuperVision function for the appliance has been turned off.
- Buzzer Tones
You can select whether the audible signals are turned on (On) or turned off (Off) for this appliance.

RemoteUpdate

The RemoteUpdate menu option is only displayed and can only be selected if the requirements for using Miele@home have been met (see “Before using for the first time – Miele@home”).

The RemoteUpdate function is used for updating the software in your oven. If an update is available for your oven, it will automatically download it. Updates will not be installed automatically. They must be initiated manually.

If you do not install an update, you can continue to use your oven as usual. However, Miele recommends installing updates.

Activating/deactivating

The RemoteUpdate function is activated as standard. Available updates will be downloaded automatically but will only be installed if you initiate installation manually.

Deactivate RemoteUpdate if you do not want any updates to be downloaded automatically.

Settings

Running a RemoteUpdate

Information about the content and scope of an update is provided in the Miele app.

A message will appear on your oven display if a software update is available.

You can install the update immediately or postpone this until later. When the oven is turned on again, you will be reminded about the update.

Deactivate RemoteUpdate if you do not want to install the update.

The update may take several minutes.

Please note the following information about the RemoteUpdate function:

- You will only receive a message when an update is available.
- Once an update has been installed, it cannot be undone.
- Do not turn the oven off during the update. Otherwise, the update will be aborted and will not be installed.
- Some software updates can only be carried out by Miele Customer Service.

Lift-up panel

Regardless of the setting selected, as soon as you start the Self Clean program the lift panel will go down automatically.

- Automatic

The lift panel raises automatically as soon as you turn the range on.

The lift panel goes down automatically as soon as you turn the range off.

- Manual

Touch the *Lift Panel* sensor button to raise and lower the lift panel.

Electrical version

You can set the voltage variant. The setting must correspond to the voltage of your domestic electrical supply.

Calibrate temperature

You can change the temperature in increments in all operating modes and automatic programs so that it is higher or lower in the oven compartment than displayed.

The temperature calibration is represented by a bar with seven segments.



If all of the segments are filled, the oven compartment temperature is much higher than displayed. If one segment is filled, the oven compartment temperature is much lower than displayed.

Software version

The software version menu option is for use by Miele Technical Service. You do not need this information for domestic use.

- Confirm with *OK*.

Legal information

You can find an overview of the integrated open-source components under Open Source Licenses.

- Confirm with *OK*.

Showroom Program

This function enables the oven to be demonstrated in dealer showrooms without heating up. Do not activate this setting for domestic use.

Demo Mode

If you have Demo mode activated, Demo mode is active. The appliance will not heat up will appear when you turn on the oven.

- On
Touch *OK* for at least 4 seconds to activate Demo mode.
- Off
Touch *OK* for at least 4 seconds to deactivate Demo mode. You can use the oven as normal.

Factory default

- Appliance settings
Any settings that have been altered will be reset to the factory default settings.
- Favorites
All Favorites will be deleted.
- MyMiele
All MyMiele entries will be deleted.
- Recommended power levels
Microwave power levels which have been changed will be reset to the factory default settings.
- Recommended temperatures
Any recommended temperatures that have been changed will be reset to the factory default settings.

Operating hours (total)

Select Operating hours (total) to query the total number of operating hours of your oven.

Alarm + Timer

Using the *Timer* sensor button, you can set a timer (e.g., for boiling eggs) or an alarm for a specific time.

Two alarms, two timers, or an alarm and a timer can be set simultaneously.

Using the Alarm function

The  alarm can be used to specify a particular time for an audible signal to sound.

Setting the alarm

If the Display | QuickTouch | Off setting is selected, you will need to turn the oven on before setting the alarm. The alarm time will then appear on the display when the oven is turned off.

- Select the *Timer* sensor button.
- Select  Alarm.
- Set the time for the alarm.
- Tap *Close* to confirm.

When the oven is turned off, the alarm time and  will appear instead of the time of day.

If you are cooking at the same time or if you are in a different menu, the alarm time and  will appear in the top right-hand corner of the display.

At the specified time for the alarm,  will flash on the display next to the time and an audible signal will sound.

- Select the *Timer* sensor button or the set alarm time on the display.

The audible signal will stop and the symbols on the display will go out.

Changing an alarm

- Select the alarm on the display or select the *Timer* sensor button and the alarm you want.

The set alarm time will appear on the display.

- Set the new time for the alarm.
- Tap *Close* to confirm.

The adjusted alarm time is now saved and will appear on the display.

Deleting an alarm

- Select the alarm on the display or select the *Timer* sensor button and the alarm you want.

The set alarm time will appear on the display.

- Select *Delete*.
- Tap *Close* to confirm.

The alarm is deleted.

Using the Timer function

The ⏰ timer can be used to time other activities in the kitchen, e.g., boiling eggs.

The timer can also be used at the same time as a cooking program for which the start and finish times have been set (e.g., as a reminder to stir the food or add seasoning, etc.).

- The maximum timer duration that can be set is 59 minutes and 59 seconds.

Setting the timer

If you have selected the **Display | QuickTouch | Off** setting, you will need to turn the oven on before setting the timer. The timer can then be seen counting down on the display when the oven is turned off.

Example: you want to boil some eggs and set a timer of 6 minutes and 20 seconds.

- Select the *Timer* sensor button.
- Select ⏰ *Timer*.
- Set the required timer duration.
- Tap **Close** to confirm.

When the oven is turned off, the timer duration counts down on the display and ⏰ appears instead of the time of day.

If you are cooking at the same time or if you are in a different menu, the timer duration and ⏰ will appear in the top right-hand corner of the display.

At the end of the timer duration, ⏰ will flash, the time will start counting up, and an audible signal will sound.

- Select the *Timer* sensor button or the required timer on the display.

The audible signal will stop and the symbols on the display will go out.

Changing the timer

- Select the timer on the display or select the *Timer* sensor button and then the timer duration you want.

The set timer duration will appear.

- Set a new timer duration.
- Tap **Close** to confirm.

The changed timer duration is now saved and will count down in minutes. Timer durations of less than 10 minutes will count down in seconds.

Deleting the timer

- Select the timer on the display or select the *Timer* sensor button and then the timer duration you want.















The set timer duration will appear.

- Select **Delete**.
- Tap **Close** to confirm.







The timer is deleted.

Main and submenus

As different countries have different preferences when it comes to preparing food, the temperatures in °F and °C may not match. The temperatures are defined as they are specified in the table.

| Menu | Recommended value | Range |
|--|---|--|
| Operating Modes <input type="checkbox"/> | | |
| Convection Bake  | 350°F (160°C) | 85–475°F (30–250°C) |
| Convection Roast  | 375°F (170°C) | 85–475°F (30–250°C) |
| Surround <input type="checkbox"/> | 400°F (180°C) | 85–475°F (30–250°C) |
| Microwave  | 7 | 1–7 |
| Combination Modes  | | |
| Combi Conv Bake/ Combi Conv Roast  | 3 325°F (160°C) | 1–3 85–450°F (30–220°C) |
| Combi Conv Broil  | 3 350°F (200°C) | 1–3 200–400°F (100–200°C) |
| Combi Broil  | 3  3  | 1–3  1–3  |
| Combi Auto Roast  | 3 350°F (160°C) | 1–3 200–400°F (100–200°C) |
| Intensive  | 350°F (170°C) | 125–450°F (50–220°C) |
| Auto Roast <input type="checkbox"/> | 350°F (160°C) | 200–450°F (100–230°C) |
| Bake <input type="checkbox"/> | 350°F (190°C) | 200–400°F (100–200°C) |
| Maxi Broil  | 3 | 1–3 |
| Convection Broil  | 350°F (200°C) | 200–475°F (100–220°C) |

Main and submenus

| Menu | Recommended value | Range |
|---|------------------------------------|--|
| Automatic Programs  | | |
| Special Modes  | | |
| Popcorn | 6 | – |
| Defrost | – | – |
| Dehydrate | 200°F (90°C) | 175–225°F (80–100°C) |
| Reheat | – | – |
| Warm-up Cookware | 175°F (80°C) | 125–225°F (50–100°C) |
| Proof | 100°F (35°C) | 85–125°F (30–50°C) |
| Slow Roasting | 225°F (100°C) | 175–250°F (80–120°C) |
| Sabbath Program Surround Bake | 350°F (180°C) 350°F (180°C) | 120–475°F (50–250°C) 120–475°F (50–250°C) |
| Keep warm | 175°F (75°C) | 125–200°F (60–90°C) |
| MyMiele   | | |
| Favorites  | | |
| Settings  | | |

Microwave operation

How it works

The oven contains a magnetron that converts electrical energy into electromagnetic waves (microwaves). These microwaves are distributed evenly throughout the oven compartment and are also reflected by the metal walls inside the oven.

The microwaves penetrate the food from all sides. Food consists of many molecules. When subjected to microwave energy, these molecules (particularly the water molecules) start to oscillate. This heats the food from the outside to the inside. The more water a food contains, the faster it is reheated or cooked.

Advantages of the microwave oven

- Food can generally be cooked with little or no liquid or cooking oil.
- The times for defrosting, reheating, or cooking are shorter than with a cooktop or oven.
- Vitamins, minerals, natural color, and taste of the food are generally retained.

Suitable dishware

In order for microwaves to reach the food, they must be able to penetrate the dishware being used. Microwaves can pass through porcelain, glass, cardboard, and plastics, but not metal. Therefore, do not use metal containers or dishware that contains metal. Metal reflects the microwaves which can create sparks and the microwaves are not absorbed by the metal.

 Danger of injury from increased pressure in sealed containers or bottles

Pressure can build up when reheating food or drinks in sealed containers or bottles, which can cause them to explode.

Never cook or reheat solid or liquid food in sealed containers or bottles. Open containers beforehand and, with baby bottles, remove the screw top and teat.

 Risk of fire due to using unsuitable dishware for operating modes which use microwave power.

Dishware which is not suitable for use in microwave ovens can be badly damaged and cause damage to the oven.

Only use microwave-safe dishware for operating modes which use microwave power.

The material and shape of dishware used affect reheating and cooking durations.

Heat distribution is more even in round

and oval-shaped flat containers. Food is reheated more evenly in these containers than in square ones.

Suitable dishware

 Fire hazard due to flammable materials.

Disposable containers made out of plastic, paper, or other flammable materials can ignite, causing damage to the oven.

Do not leave the oven unattended when reheating or cooking food in disposable containers made of plastic, paper, or other flammable materials.

You can use the following dishware and materials:

- Heat-resistant glass and ceramic glass
Exception: crystal glass as it contains lead and may crack.
- Porcelain
 - Without metallic decoration
Metallic decoration (e.g., gold rims or cobalt blue) can cause sparking.
 - Without hollow knobs and handles
Moisture can gather in hollow knobs and handles. When the moisture evaporates, pressure can build up and the item can explode.
- Unpainted stoneware and stoneware with underglaze paints

 Danger of injury caused by hot dishware.

Stoneware can get hot.





Use pot holders when using stoneware.

- Plastic dishware and disposable plastic containers with the Microwave  operating mode

Tip: To protect the environment, avoid the use of disposable containers.

Plastic dishware must be heat-resistant to a minimum of 230°F (110°C). Otherwise, the plastic may melt and fuse with the food.

Only use plastic dishware with the Microwave  operating mode.

Do not use plastic dishware with the Combi Auto Roast , Combi Conv Bake/Combi Conv Roast , Combi Broil , or Combi Conv Broil  operating modes.









- Microwave-safe plastic dishware
Special plastic dishware designed for use in microwave ovens is available from retail outlets.
- Styrofoam dishware
For briefly heating food.
- Plastic boiling bags
For cooking and reheating. They should be pierced before use. The holes allow the steam to escape. This prevents a build-up of pressure from forming and the bag from bursting. There are also special bags available for steam cooking which do not need to be pierced. Please follow instructions given on the packet.

Microwave operation

- Roasting bags and tubes
Please follow the manufacturer's instructions.

 Risk of fire due to metal parts. Metal parts such as metal clips or plastic and paper ties that have wire running through them can heat flammable materials until they burn. Do not use metal clips or plastic and paper ties containing wire.

Tip: Metal tins are less suitable for operating modes which use microwave power because the metal reflects the microwaves. The microwaves only reach the cake from above, which extends the baking duration. If you use metal tins, place the tin on the glass tray so that it cannot touch the oven walls. If sparks form, do not reuse the tin for operating modes which use microwave power.

- The **supplied** wire rack is only suitable for cooking processes with the Combi Auto Roast , Combi Conv Bake/Combi Conv Roast , Combi Broil , and Combi Conv Broil  operating modes, as well as for operating modes which do not use microwave power (placed on one level).
- Metal baking tins for baking with the Combi Auto Roast , Combi Conv Bake/Combi Conv Roast , Combi Broil , and Combi Conv Broil  operating modes as well as for operating modes which do not use microwave power
- Aluminum foil trays without lids for defrosting and reheating ready meals
The food is only heated from the top.

If you remove the food from the aluminum foil container and transfer it to dishware suitable for use in a microwave oven, the heat distribution will generally be more even.

Using aluminum foil trays and aluminum foil can cause crackling and sparks.

Therefore, place aluminum foil trays on the glass tray and not on the wire rack.

Aluminum foil and aluminum foil trays must not touch the oven compartment walls and must remain at least 3/4" (2 cm) from the walls at all times.

- Metal skewers or clips
The size of the cut of meat must be much larger than the metal skewers and clips.

Unsuitable dishware

Moisture can collect in the hollow spaces on dishware and lids with hollow handles or knobs. When the moisture evaporates, pressure can build up and the item can explode. If the hollow recess is sufficiently ventilated, the item can be used.

Do not use dishware with hollow knobs or handles for cooking.

When purchasing plasticware, make sure that it is suitable for use in a microwave oven.

- Wooden dishes
Water contained in wood evaporates during the cooking process. This causes the wood to dry and crack.

Do **not** use the following dishware and material:

- Wire racks (including the supplied wire rack) are **not** suitable for use with the Microwave  operating mode.
- Metal containers
- Aluminum foil
Exception: for even defrosting, reheating, or cooking of unevenly shaped cuts of meat, e.g., poultry, small pieces of aluminum foil may be used to cover thin parts for the last few minutes of the process.
- Metal clips or plastic or paper ties containing wire
- Plastic containers where the aluminum lid has not been completely removed
- Crystal glass
- Utensils and dishware with metallic decoration (e.g., gold rims, cobalt blue)
- Dishware with hollow handles
- Plasticware made of melamine
Melamine absorbs microwave energy and gets hot.

Microwave operation

Testing dishware

Unsuitable dishware can cause sparks or crackling noises in microwave operation. If you are not sure whether glass, porcelain, or stoneware dishware is suitable, test the dishes.

This test cannot be used to check whether items with hollow knobs or handles are suitable for use.

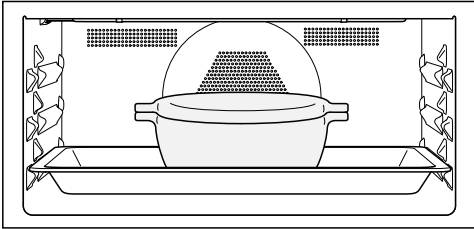

- Place the empty dishware in the middle of the glass tray and insert the tray in shelf level 1.

- Close the door.
- Select the Microwave  operating mode.
- Set the highest microwave power level (level 7) and a cooking duration of 30 seconds.
- Start the process.
- Observe the dishware during the entire duration.
- Immediately open the door if there are sparks or crackling noises.

If there are sparks or if you can hear crackling noises, the tested dishware is not suitable for microwave use.

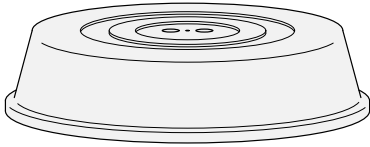

Cover



Tip: Covers are available from retail outlets.

- A cover prevents too much steam escaping, especially when cooking foods which need longer to cook.
 - It speeds up the heating process of the food.
 - It prevents food from drying out.
 - It helps keep the oven cavity clean.
- Use a glass or plastic cover suitable for microwave use for cooking processes with the Microwave  operating mode.





Alternatively, use a cling film suitable for use in a microwave oven. Heat can cause normal cling film to melt and fuse with the food.

The cover can withstand temperatures of up to 320°F (110°C). At higher temperatures (e.g., in the Maxi Broil  or Combi Conv Bake/Combi Conv Roast  operating modes), the plastic may distort and fuse with the food.

Only use a cover for the Microwave  operating mode.

The cover should not form a seal with the container. If the container has a narrow diameter, the steam may not be able to escape. The cover could get too hot and start to melt.

Use containers with a sufficiently large diameter.

- Do **not** use a cover for heating or reheating the following types of food:
- food coated in breadcrumbs
 - food which requires a crisp finish, e.g., toast
 - food which is to be heated with the Combi Auto Roast , Combi Conv Bake/Combi Conv Roast , Combi Broil , or Combi Conv Broil  operating modes

Quick Microwave

This function can only be used when no other cooking processes are in use. Always use the glass tray.

Quick Microwave

If you select the *Minute +* sensor button, the oven starts with a set microwave power level and cooking duration, e.g., to reheat a drink.

The maximum microwave power level of 7 and a cooking duration of 1 minute are preset.

You can change the microwave power level and the cooking duration. The maximum cooking duration that can be set depends on the microwave power level selected (see section “Settings – Quick Microwave”).

- Select the *Minute +* sensor button. Touching the sensor button repeatedly increases the cooking duration in increments.

The time left will appear in the display.

You can interrupt the cooking process at any time with *Stop*, or cancel it by selecting the *Back* sensor button.

At the end of the cooking process, *Ready* appears in the display and an audible signal sounds.

- Select *Close*.

The main menu will appear.

With the wide range of automatic programs, you can achieve excellent results with ease.

Categories

The automatic programs  are sorted into categories to provide a better overview. Simply select the appropriate automatic program for the type of food you are cooking and follow the instructions on the display.

Using automatic programs

- Select Automatic Programs .

A list will appear.

- Select the food category you want.

The automatic programs available for the category selected will then appear.

- Select the automatic program that you want to use.
- Follow the instructions on the display.

Some automatic programs will prompt you to use the probe. Read the information under “Roasting – Probe”.

Core temperatures cannot be changed for automatic programs.

Tip: Use  Info to display information such as how to place or turn the food depending on the cooking program.

Usage notes

- After cooking, allow the oven compartment to cool down to room temperature again before starting a automatic program.
- Some automatic programs require a preheating phase before food can be placed in the oven. A prompt will appear on the display indicating when this needs to be done.
- Some automatic programs require liquid to be added during the cooking process. You will be prompted by a message on the display when this needs to be done (e.g., for adding liquid).
- The duration quoted for automatic programs is an estimate. It may increase or decrease depending on the program. The duration, in particular with meat, will vary depending on the initial temperature of the food.
- When you use the probe, the cooking duration will depend on when the core temperature is reached.
- If by the end of a automatic program the food is not cooked enough for your taste, select *Continue cooking* or *Continue baking*. Conventional heating will then be used for 3 minutes to continue cooking or baking the food.

Automatic Programs

Search

(Depending on language)

Under Automatic Programs, you can search by the name of the categories and the automatic programs.

This search is a full-text search and can also be used to search for parts of words.

From the main menu:

- Select Automatic Programs .

The category list will appear on the display.

- Select Search.
- Use the keyboard to type in the search text, e.g., "Bread".

The number of hits will be shown in the footer.

If no match is found or if there are more than 40 matches, the hits field will be deactivated and you will need to change the search text.

- Select XX hits.

The categories and automatic programs found will then appear.

- Select the automatic program you want, or the category and then the automatic program you want.

The automatic program will start.

- Follow the instructions on the display.

This section provides information on the following applications:

- Popcorn
- Defrost
- Dehydrate
- Reheat
- Warm-up Cookware
- Proof
- Slow Roasting
- Sabbath Program
- Keep warm
- Cooking
- Canning
- Frozen food/ready meals

Popcorn

If you select the Popcorn program, the oven starts with a set microwave power level and cooking duration.

Microwave power level 6 and a cooking duration of 2:50 minutes are preset.

These settings match the manufacturer's instructions on most bags of microwave popcorn.

The maximum cooking duration that can be set is 4 minutes. The microwave power level is set and cannot be modified (see section "Settings – Popcorn").

■ Select Special Modes .

■ Select Popcorn.

The time left will appear in the display.

You can interrupt the cooking process at any time with *Stop*, or cancel it by selecting the *Back* sensor button.

Disposable containers made out of paper or other flammable materials can ignite, causing damage to the oven.

Do not leave the oven unattended during the cooking process and make sure you follow the instructions on the packaging.

At the end of the cooking process, *Ready* appears in the display and an audible signal sounds.



■ Select *Close*.

The main menu will appear.

Special Modes

Defrost

Gentle defrosting of frozen food means that the vitamins and minerals are generally retained.

- Use one of the following operating modes and Special Modes:
 - Special Modes  | Defrost
Select a category and the weight for the food.
 - Operating Modes  | Microwave 
Set the microwave power level and the defrosting duration.

 Risk of infection from bacteria. Bacteria such as salmonella can cause life-threatening food poisoning.

It is particularly important to observe food hygiene rules when defrosting fish and meat, and in particular when defrosting poultry.

Do not use the liquid produced during defrosting.

Process the food as required as soon as it has been defrosted.

Tips

- Place the food to be defrosted on the glass tray without its packaging.
- For defrosting poultry, use the glass tray with the wire rack placed on top of it. This way the frozen food will not be lying in the defrosted liquid.
- Meat, poultry, or fish does not need to be fully defrosted before cooking. Defrost until the food has started to thaw. The surface will then be sufficiently thawed to take herbs and seasoning.

Using the Defrost Special Mode

Use the “Defrost” mode to gently defrost frozen food.

Only use dishware that is microwave safe.

- Select Special Modes .
 - Select Defrost.
- A list will appear.
- Select the desired food category.
 - Enter the weight of the frozen food.

You can start the defrosting process immediately or delay the start and display the individual actions and cooking stages.

- Follow the instructions on the display.

Tips

- Use  Info to display information such as when to turn the frozen food, depending on the cooking process.
- If the frozen food is not defrosted properly by the end of the defrosting process, select **Cont. Keep warm**. The frozen food will continue to be heated for 3 minutes.
- After the defrosting process has ended, select **Save** to save the settings for the selected category and weight as a Favorite (see “Favorites”).

Using the Microwave operating mode

Instead of the Special Mode, you can use the Microwave  operating mode for defrosting. Set the microwave power level and the defrosting duration.



The time required depends on the nature of the food, its initial temperature, and the amount to be cooked. Take note of the standing times.

Only use dishware that is microwave safe.

- Select Operating Modes .
- Select Microwave .
- Depending on the type of food, set the microwave power level and the defrosting duration specified in the chart.
- In general you are advised to select the middle duration.
- Place the food on the glass tray on shelf level 1 in the oven cavity.

Special Modes

Defrosting with the Microwave operating mode

| Food to be defrosted | Quantity |  |  [min] |  [min] |
|---------------------------------------|---------------------------|---|--|---|
| Butter | 1/2 lb (250 g) | 1 | 8–10 | 5–10 |
| Milk | 4 1/4 c (1000 ml) | 4 | 12–16 | 10–15 |
| Sponge cake (3 slices) | Approx. 0.6 lb (300 g) | 2 | 4–6 | 5–10 |
| Fruit cake (3 slices) | Approx. 0.6 lb (300 g) | 2 | 6–8 | 10–15 |
| Butter cake (3 slices) | Approx. 0.6 lb (300 g) | 2 | 6–8 | 5–10 |
| Cream cake (3 slices) | Approx. 0.6 lb (300 g) | 1 | 4–4:30 | 5–10 |
| Yeast rolls, puff pastries (3 pieces) | Approx. 0.6 lb (300 g) | 2 | 6–8 | 5–10 |

 Microwave power level,  defrosting time,  standing time

¹ Allow food to stand at room temperature. This standing time allows the heat to spread evenly throughout the food.





Dehydrate



Dehydrating or drying is a traditional method of preserving fruit, certain vegetables, and herbs.

It is important to check that fruit and vegetables are fresh, ripe and unbruised before they are dehydrated.

- Prepare the food for drying by cutting it up, and peeling and coring it if necessary.
- Depending on how big it is, distribute the food for drying as evenly as possible over the rack or glass tray in a single layer.
- Dry on a maximum of 2 levels at the same time.
Place the food for drying on shelf levels 1+2.
If you are using both the rack and glass tray, insert the glass tray below the rack.
- Select Special Modes .
- Select Dehydrate.
- Alter the recommended temperature if necessary and then set the time.
- Follow the instructions on the display.
- Turn the food being dried on the glass tray at regular intervals.

The drying times are longer for whole or halved food.

| Food for drying |  | 🌡️ °F [°C] | 🕒 [h] |
|-----------------|---|--------------------|-------|
| Fruit |  | 140-160 (60-70) | 2-8 |
| Vegetables |  | 130-150 (55-65) | 4-12 |
| Mushrooms |  | 115-125 (45-50) | 5-10 |
| Herbs* |  | 85-95 (30-35) | 4-8 |

-  special mode/operating mode, 🌡️ temperature, 🕒 drying time,
-  special mode Dehydrate,
-  operating mode Surround

* When drying herbs, always use the glass tray on shelf level 2 and use the Surround  operating mode, as the fan is switched on in the Dehydrate special mode.

- Reduce the temperature if condensation begins to form in the oven.

Removing the dried food

 Risk of injury caused by hot surfaces.

The oven gets hot during operation. You could burn yourself on the heating elements, oven compartment, or accessories. Use pot holders when removing the food from the oven.

- Allow the fruit or vegetables to cool down after dehydrating.

Dried fruit must be completely dry, but also soft and elastic. Juice should not escape when cut.

- Store dried food in sealed glass jars or cans.

Special Modes

Reheat

It is essential that the information in “IMPORTANT SAFETY INSTRUCTIONS – Correct use” is observed.

 Danger of injury caused by hot food.

If food for babies and children is heated at too high a temperature, they can burn themselves.

Only heat food for babies and children for 30–60 seconds at microwave power level 4.

After heating food, especially food for babies and small children, stir the food or shake the container and taste the food so that children do not get burned.

 Danger of injury from increased pressure in sealed containers or bottles.

Pressure can build up during reheating in sealed containers or bottles, causing them to explode.

Never cook or reheat food or liquids in sealed containers or bottles. Open containers beforehand and with baby bottles, the screw top and teat must be removed.

Danger of injury caused by hot liquids.

When heating food, and in particular liquids, using the

Microwave  operating mode, the boiling point may be reached without the typical bubbles being produced. The liquid does not boil evenly throughout.

This boiling delay can result in the liquid boiling over explosively. Take care when taking the container out of the oven, as the hot liquid can cause severe scalding. Under certain circumstances, the pressure can be so high that the door opens automatically.

Stir liquids well before heating or cooking.

After heating, wait at least 20 seconds before removing the container from the oven.

In addition, you can place a glass rod or similar item, if available, in the container during the heating process.

Using the Reheat Special Mode

This program is designed for reheating food.

The time required depends on the nature of the food, its initial temperature, and the amount to be cooked. For example, food taken straight from the refrigerator takes longer to reheat than food which has been kept at room temperature. Take note of the standing times.

Only use dishware that is microwave safe.

Always cover food when reheating it, except when reheating meat/fish coated in breadcrumbs.

- Place the food that is to be reheated on the glass tray with a cover.

- Select Special Modes .

- Select Reheat.

A list will appear.

- Select the desired food category.

- Enter the weight of the food.

- Follow the instructions on the display.

 Danger of burning due to hot surfaces.

The oven gets hot during operation. You could burn yourself on the heater elements, oven cavity, or accessories. Condensation may accumulate on the bottom of the dishware.

Use pot holders when working in the hot oven cavity and when removing the dishware.

During the standing time, the temperature is distributed evenly in the food.



- After reheating, allow the food to stand at room temperature for a few minutes to enable the heat to spread evenly throughout the food.

Tips

- Always cover food when reheating it, except when reheating meat/fish coated in breadcrumbs.
- Use  Info to display information such as when to turn or stir the food, depending on the cooking process. Stir the food from the outside towards the middle, as food heats more quickly from the outside.
- If the food is not hot enough at the end of the program, select *Cont. Keep warm*. The food will continue to be heated for 3 minutes.
- After the program has finished, select *Save* to save the settings for the selected category and weight as a Favorite (see “Favorites”).

Special Modes

Reheating with the Microwave operating mode

| Drink/ Food | Quantity |  |  [min] |  ¹ [min] |
|---|-----------------------------|---|--|--|
| Drinks (drinking temperature 140-150°F (60-65°C)) | 1 cup/1 glass (8 oz/200 ml) | 7 | 00:50-1:10 | - |
| Baby bottle (milk) ² | Approx. 8 oz (200 ml) | 4 | 00:50-1:00 ³ | 1 |
| Food for babies and children ³ | 1 jar (8 oz/200 g) | 4 | 00:30-1:00 | 1 |
| Sliced meat with sauce ³ | 8 oz (200 g) | 5 | 3:00-5:00 | 1 |
| Side dishes ³ | 1/2 lb (250 g) | 5 | 3:00-5:00 | 1 |

 Microwave power level,  cooking duration,  standing time

- ¹ Allow food to stand at room temperature. This standing time allows the heat to spread evenly throughout the food.
- ² A boiling delay can be avoided by stirring liquids before reheating them. After heating, wait at least 20 seconds before removing the container from the oven. In addition, you can place a glass rod or similar item, if available, in the container during the heating process.
- ³ The durations apply to food with an initial temperature of approx. 40°F (5°C). For food not normally refrigerated, durations apply to food at room temperature of approx. 105°F (20°C).
With the exception of baby food and delicate whisked sauces, food should be heated to a temperature of 155-165°F (70-75°C).

Warm-up Cookware

Preheating the dishware means that food does not cool down as quickly.

Use heat-resistant dishware.

- Place the wire rack on shelf level 1 and place the dishware to be heated on it. Depending on the size of the dishware, you can also place it on the oven floor.
- Select Special Modes .
- Select Warm-up Cookware.
- Alter the recommended temperature if necessary and then set the time.
- Follow the instructions on the display.

 Danger of injury caused by hot surfaces.

The oven gets hot during operation. You could burn yourself on the heater elements, oven cavity, or accessories. Condensation may accumulate on the bottom of the dishware.

Use pot holders when removing dishware.

Proof

This program is designed specifically for proofing dough.

- Select Special Modes .
- Select Proof.
- If necessary, adjust the recommended temperature and set the cooking duration.
- Follow the instructions on the display.

Keep warm

You can keep food warm in the oven for several hours.

In order to maintain the quality of food, select the shortest possible time.

- Select Special Modes .
- Select Keep warm.
- Place the food to be kept warm in the oven and confirm with *OK*.
- Alter the recommended temperature if necessary and then set the time.
- Follow the instructions on the display.

Special Modes

Slow Roasting

The Slow Roasting method is ideal for cooking beef, pork, veal, or lamb when you want a tender result.

Always observe USDA/CFIA food safety guidelines.

First briefly sear the meat on all sides at a high temperature on the cooktop in order to seal it.

Then place the meat in the preheated oven compartment where the low temperature and long cooking duration will cook it to perfection and ensure it is very tender.

The meat will relax. The juices inside will start to circulate evenly throughout the meat to reach the outer layers. This gives very tender and succulent results.

- Only use lean meat which has been correctly seasoned and trimmed. Bones should be removed before cooking.
- For searing, use a suitable cooking oil or fat that can withstand high temperatures (e.g., clarified butter, vegetable oil).
- Do not cover meat during the cooking process.

The cooking duration takes approx. 2–4 hours depending on the weight and size of the meat and how well you want it cooked.

- As soon as the cooking process has finished, you can carve the meat straight from the oven. It does not need to rest.

- You can leave the meat in the oven to keep warm until you serve it. This will not affect results in any way.
- Serve on preheated plates with very hot sauce or gravy to prevent it cooling down too quickly. The meat is at an ideal temperature to eat straight away.

Using the Slow Roasting Special Mode

Observe the information under “Roasting – Precision Probe”.

- Select Special Modes .
- Select Slow Roasting.
- Follow the instructions on the display. Place the necessary accessories in the oven compartment for the preheating phase.
- Set the temperature and the core temperature.
- While the oven is preheating, sear the meat on all sides on the cooktop.

 Danger of burning due to hot surfaces.



The oven gets hot during operation. You could burn yourself on the heating elements, oven compartment, or accessories. When the oven is hot, use pot holders to insert, remove, or turn food, as well as when adjusting the oven shelves, etc.

- **Once** Insert the probe and place food in the oven **appears on the display**, place the seared meat on the wire rack and insert the probe so that the metal tip is fully in the center of the meat.
- Close the door.

At the end of the program, Ready will appear on the display and an audible signal will sound.

Using the Surround operating mode

Use the glass tray with the wire rack placed on top of it.
Turn off the **Booster** function for the preheating phase.

- Place the glass tray with a wire rack on shelf level 1.
- Select Operating Modes .
- Select the Surround  operating mode and a temperature of 210°F (100°C).
- Turn off the **Booster** function via the pull-down menu.
- Preheat the oven with the glass tray and the wire rack inside for approx. 15 minutes.
- While the oven is preheating, sear the meat on all sides on the cooktop.

 Danger of burning due to hot surfaces.

The oven gets hot during operation. You could burn yourself on the heater elements, oven cavity, or accessories.

Use pot holders when placing food in the appliance or removing it and when working in the hot oven cavity.

- Place the seared meat on the wire rack.
- Reduce the temperature to 195°F (90°C).
- Continue cooking the meat until it is done.

Special Modes

Cooking durations/core temperatures

Always observe USDA/CFIA food safety guidelines.

| Meat | Cooking duration | Core temperature |
|--|---|---|
| Beef tenderloin, approx. 2.2 lbs (1 kg) - rare - medium - well done | 60–80 min 75–85 min 110–130 min | 113–119°F (45–48°C) 129–135°F (54–57°C) 145–151°F (63–66°C) |
| Prime rib, approx. 2.2 lbs (1 kg) - rare - medium - well done | 70–80 min 105–115 min 130–140 min | 113–119°F (45–48°C) 129–135°F (54–57°C) 145–151°F (63–66°C) |
| Pork tenderloin, approx. 0.75 lbs (350 g) | 70–90 min | 145–156°F (63–69°C) |
| Gammon joint*, approx. 2.2 lbs (1 kg) | 140–160 min | 145–151°F (63–66°C) |
| Veal tenderloin, approx. 2.2 lbs (1 kg) - pink - medium - well done | 45–55 min 75–85 min 90–100 min | 113–119°F (45–48°C) 129–135°F (54–57°C) 145–151°F (63–66°C) |
| Saddle of veal*, approx. 2.2 lbs (1 kg) - pink - medium - well done | 75–85 min 100–130 min 130–140 min | 113–119°F (45–48°C) 129–135°F (54–57°C) 145–151°F (63–66°C) |
| Saddle of lamb* | 40–60 min | 129–151°F (54–66°C) |

* Boneless

Sabbath Program

The Sabbath Program and Yom-Tov Special Modes help to support religious observance.

To comply with the Sabbath regulations, follow the instructions on the display.

The oven heats up to the temperature you have set and maintains this temperature for a maximum of 24 hours (Sabbath Program) or 76 hours (Yom-Tov). In both Special Modes, the oven turns off automatically after 76 hours.

- Turn off cabinet door front recognition.
- Place the food in the oven.
- Select Special Modes .
- Select Sabbath Program.
- Select the Special Mode you want (Sabbath Program or Yom-Tov).
- Select the operating mode you want to use.

You will not be able to start the Special Mode if you have set a timer or alarm.

Once a Special Mode has started, it cannot be changed or saved under Favorites.

The Special Mode will be canceled in the event of a power failure. After a power failure, the oven will only remain in compliance with Sabbath regulations for as long as it continues to be disconnected from the power supply. As soon as the connection is restored, Power failure -Program cancelled is displayed.

Using Sabbath Program

This Special Mode is suitable for the weekly Sabbath (Shabbat). You can use it to keep food warm for up to 24 hours, until after the first door opening.

- Set the temperature.
- Select Start.

Sabbath Program and the set temperature will appear in the display.

The oven heating will turn on around 30 seconds after you have closed the door. The oven interior lighting will remain on during the entire cooking process.

The time of day will not appear. The motion sensor will not respond, and neither will any of the sensor buttons (except for the On/Off switch .

The following message is displayed: Sabbath - Do not open the door. This message disappears after approx. 45 minutes and is displayed again from time to time after that.

Special Modes

If the message is **not** displayed, the oven is not heating up and you can open the door and close it again. As soon as you have opened the door for the first time, the oven heating **remains turned off** until the end of the Special Mode.

If you leave the door closed until the end of the Special Mode, the oven heating will only turn off after 24 hours. The oven remains turned on.

- If you want to end the Special Mode prematurely, turn off the oven using the On/Off switch .

After the end of the Special Mode, the notification Sabbath - Do not open the door disappears and the oven heating turns off. The rest of the notifications remain visible in the display until the oven turns off automatically after 76 hours.

Using Yom-Tov

This Special Mode is suitable for days of observance spanning several days across the week. You can use it to keep food warm for up to 76 hours. You can open and close the door multiple times during this time.

- Set the temperature.
- Select Start.

Yom-Tov and the set temperature will appear in the display.

The oven heating will turn on around 30 seconds after you have closed the door. The oven interior lighting will remain on during the entire cooking process.

The time of day will not appear. The motion sensor will not respond, and neither will any of the sensor buttons (except for the On/Off switch .

The following message is displayed: Sabbath - Do not open the door. This message disappears after approx. 45 minutes and is displayed again from time to time after that.

If the message is **not** displayed, you can open and close the door multiple times. The oven heating **remains on**.

- If you want to end the Special Mode prematurely, turn off the oven using the On/Off switch .

The oven heating remains turned on until the end of the Special Mode. The oven will turn off automatically after 76 hours.

Cooking

It is essential that the information in “IMPORTANT SAFETY INSTRUCTIONS – Correct use” is observed.

Food with a thick skin or peel, such as tomatoes, sausages, potatoes, and eggplant can burst when heated or cooked.

Pierce or score the skin of these foods several times to allow steam to escape.

Eggs heated in their shell can burst, even after they have been removed from the oven.



Eggs can only be cooked in their shells in a specially designed egg-boiling device. Do not reheat hard-boiled eggs using the Microwave  operating mode.

If possible, use the probe to monitor the temperature when cooking (see “Roasting – Probe”).

Set the core temperature:





- fish: at least 158°F (70°C)
- poultry: at least 185°F (85°C)

Tips

- Turn, separate, or stir the food several times. Stir the food from the outside towards the middle, as food heats more quickly from the outside.
- Use only dishware that is suitable for use in a microwave and oven when using operating modes which use microwave power.
- If possible, use MasterChef for cooking.
- Never use a lid with the Combi Conv Broil  and Combi Broil  operating modes, as the food will not brown.
- Select microwave power level 6 in the Microwave  operating mode to start cooking and then continue cooking at power level 4.

Special Modes

Cooking with the Microwave operating mode

| Soups/stews Vegetables |  [g] | Level 6  [min] | + | Level 4  [min] |  ¹ [min] |
|-----------------------------------|--|--|---|--|--|
| Stew | 1500 | 10 | + | 20 | 1 |
| Soup | 1500 | 11 | + | 24 | 1 |
| Peas | 500 | 5 | + | 10 | 2 |
| Peas (frozen) | 450 | 5 | + | 12 | 2 |
| Carrots | 500 | 5 | + | 10 | 2 |
| Broccoli florets | 500 | 6 | + | 8 | 2 |
| Broccoli (frozen) | 450 | 5 | + | 11 | 2 |
| Cauliflower florets | 500 | 6 | + | 10 | 2 |
| Kohlrabi batons | 500 | 3 | + | 8 | 2 |
| Asparagus | 500 | 5 | + | 8 | 2 |
| Leeks | 500 | 5 | + | 8 | 2 |
| Leeks (frozen) | 450 | 5 | + | 8 | 2 |
| Peppers, cut into strips | 500 | 5 | + | 10 | 2 |
| Beans, green | 500 | 4 | + | 12 | 2 |
| Brussels sprouts | 500 | 5 | + | 12 | 2 |
| Brussels sprouts (frozen) | 450 | 5 | + | 10 | 2 |
| Mixed vegetables (frozen) | 450 | 5 | + | 12 | 2 |

 Weight,  cooking duration,  standing time

¹ Allow food to stand at room temperature. This standing time allows the heat to spread evenly throughout the food.

Canning

 Risk of infection from bacteria. The spores of the botulinum bacterium are not sufficiently killed by canning legumes and meat only once. Toxins may form which can lead to serious poisoning. These spores are only destroyed by canning the food again.

After they have cooled down, **always** reheat legumes and meat a second time within 2 days.



 Risk of injury from increased pressure in sealed cans. Canning food and heating it up in closed containers results in an increase in pressure which can cause them to explode. Do not use cans for canning or reheating food.

Always observe USDA/CFIA food safety guidelines.

Preparing fruit and vegetables

The instructions are for a maximum of 5 jars with a capacity of 0.5 L each.

Only use jars that are specifically designed for canning:

- Convection Bake : bottling jars with a screw cap
- Microwave : microwave-safe bottling jars with glass lids, sealed with clear adhesive tape

- Only use undamaged jars and rubber rings.
- Rinse the jars with hot water before canning and fill them up to a maximum of 3/4" (2 cm) below the rim.
- After filling the jars, clean the outside of the rims with a clean cloth and hot water.
- Seal the jars with clear adhesive tape. Do not use any metal clips as they cause sparks when used with the Microwave  operating mode.
- Insert the glass tray on shelf level 1 and place the jars on it.

Using the Convection Bake operating mode

- Select the Convection Bake  operating mode and a temperature of 320-340°F (160-170°C).
- Wait until bubbles rise evenly in the jars.

Then reduce the temperature to prevent the contents from boiling over.



Special Modes

Canning fruit and vegetables

- Set the specified post-canning warming temperature as soon as bubbles are visible in the jars, then leave the jars in the warm oven for the time specified.

Canning vegetables

- As soon as bubbles are visible in the jars, set the specified canning temperature and cook the vegetables for the time specified.
- After canning, set the specified post-canning warming temperature, then leave the jars in the warm oven for the time specified.

| |  |  |
|-------------------------|---|---|
| Fruit | -/- | 85°F (30°C) 25–35 min |
| Pickling cucumbers | -/- | 85°F (30°C) 25–30 min |
| Red beets | 250°F (120°C) 30–40 min | 85°F (30°C) 25–30 min |
| Beans (green or yellow) | 250°F (120°C) 90–120 min | 85°F (30°C) 25–30 min |

 Canning temperature and time once bubbles are visible in the jars

 Post-canning warming temperature and time

Using the Microwave operating mode

- Select the Microwave  operating mode and microwave power level 6.
- Wait until bubbles rise evenly in the jars. This takes about 3 minutes per jar. With 5 jars, therefore, it takes 15 minutes.



Then reduce the microwave power level to prevent the contents from boiling over.

Canning fruit and vegetables

- Switch the oven off as soon as bubbles are visible in the jars. Then leave the jars in the warm oven cavity for the time specified.

Canning vegetables

- As soon as bubbles are visible in the jars, set the specified microwave power level and cook the vegetables for the time specified.
- Switch the oven off after bottling and then leave the jars in the warm oven cavity for the time specified.

| |  |  |
|-------------------------|---|---|
| Fruit | -/- | 25–35 min |
| Pickling cucumbers | -/- | 25–30 min |
| Beets | Level 4 20–30 min | 25–30 min |
| Beans (green or yellow) | Level 4 20–30 min | 25–30 min |

 Microwave power level and bottling time, as soon as bubbles are visible

 Continued warming time

Removing the jars after canning

 Risk of injury caused by hot surfaces.

The jars will be very hot after canning.

Use oven mitts when removing the jars from the oven.

- Take the jars out of the oven.
- Cover the jars with a towel and leave to set for approx. 24 hours in a draft-free area.
- After they have cooled down, **always** reheat beans and meat a second time within 2 days.
- Remove the fasteners from the jars and make sure all jars are closed properly when storing them.

Either boil open jars again or store them in a cool place and consume the preserved fruit or vegetables immediately.

- Check the jars during storage. If jars have opened during storage or if the screw cap is bulging and does not make a popping noise when opened, dispose of the contents.

Frozen food/ready meals

Tips for cakes, pizza, and baguettes

- Bake cakes, pizza, and baguettes on parchment paper on the wire rack.
- Use the lowest temperature recommended by the manufacturer.

Tips for French fries, croquettes, and similar items

- Bake these frozen products on parchment paper on the glass tray.
- Use the lowest temperature recommended by the manufacturer.
- Turn several times during cooking.

Preparing frozen food/ready meals

Handling and cooking food correctly is essential for maintaining good health.

Cakes, pizzas, and French fries should be cooked until golden, not dark brown.

- Select the operating mode and temperatures recommended on the food's packaging.
- Preheat the oven.
- Place the food in the preheated oven on the shelf level recommended on the packaging.
- Check the food at the end of the shortest time recommended on the packaging.

MyMiele

Under MyMiele , you can save frequently used applications.

It is particularly useful with the automatic programs as you do not need to work through every menu level in order to start a program.





Tip: You can also set menu options that you have entered in MyMiele to appear on the start screen (see “Settings – Start screen”).

Adding entries

You can add up to 20 entries.

- Select MyMiele .
- Select Add entry.

You can select options from the following categories:

- Operating modes 
- Automatic Programs 
- Special Modes 
- Favorites 

- Confirm with OK.

The selected subitem and its respective symbol will appear in the list.

- Proceed as described for more entries. Only options that have not yet been selected are available for selection.

Deleting entries

- Select MyMiele .
- Touch the entry you want to delete and keep your finger on it until the context menu appears.
- Select Delete.

The entry will then be removed from the list.

Moving entries

- Select MyMiele .
- Touch the entry you want to move and keep your finger on it until the context menu appears.
- Select Move.

An orange border will appear around the entry.

- Move the entry.

The entry will now appear in the position you want it in.

You can create and save up to 20 of your own programs.

- You can combine up to 10 cooking stages to accurately program your favorite or most frequently used recipes. In each cooking stage, you can select settings such as the operating mode, temperature, and cooking duration or core temperature.
- You can specify the shelf level(s) for the food.
- You can enter a program name for your recipe.

When you next select the program, it will start automatically.

There are different ways of creating a Favorite:

- When a automatic program finishes running, save it as a separate program.
- After running a program with a set duration, save it.

Then name the program.

Creating a Favorite

- Select Favorites .
- Select Create program.

You can now specify the settings for the first cooking stage.

Follow the instructions on the display:

- Select and confirm the settings.

If you select the *Preheat* function, use *Add* to add another cooking stage where you set a cooking duration. Only then can you save or start the program.

All settings for the first cooking stage have now been set.

More cooking stages can be added, for example, if you would like to add another operating mode to follow the first.

- If additional cooking stages are required, select *Add* and proceed as for the first cooking stage.
- When you have finished setting the cooking stages, select *Set shelf level*.
- Select the level(s) you want.
- Confirm with *OK*.

If you want to check the settings or to change them at a later stage, tap the cooking stage in question.

- Select *Save*.
- Enter the program name using the keyboard.

You can add a line break for longer program names using the  symbol.

- Once you have entered the program name, select *Save*.

A message will appear on the display confirming that the name has been saved.

- Confirm with *OK*.

You can start the saved program immediately, delay the start, or change the cooking stages.

Favorites

Starting Favorites

- Place the food in the oven cavity.
- Select Favorites .
- Select the program you want to use.

Depending on the program settings, the following menu options will appear on the display:

- Start now
The program will start immediately.
The oven heating will turn on immediately.
 - Ready at
You can set the time at which the cooking program should end. The oven will turn off automatically at the time you have set.
 - Start at
You can set the time at which the cooking program should start. The oven will turn on automatically at the time you have set.
 - Display cooking stages
A summary of your settings will appear on the display.
 - Display actions
The required actions, e.g., placing the food in the oven, will appear on the display.
- Select the menu option you want.
 - Confirm the message regarding which shelf level to use with *OK*.

The selected program will begin automatically right away or at the time set.

Use  Info to display information such as how to place or turn the food depending on the cooking process.

- At the end of the program, select *Close*.

Changing cooking stages

Cooking stages in an automatic program that have been saved under a different name cannot be changed.

- Select Favorites .
- Touch the program you want to change and keep your finger on it until the context menu appears.
- Select *Change*.
- Select the cooking stage that you want to change or *Add* to add another cooking stage.
- Select and confirm the settings.
- If you want to start the modified program without changing it, select *Start*.
- Select *Save* when you have changed all the settings.

A message will appear on the display confirming that the name has been saved.

- Confirm with *OK*.

The saved program has been changed and you can start it immediately or delay the start.

Renaming Favorites

- Select Favorites .
- Touch the program you want to change and keep your finger on it until the context menu appears.
- Select Rename.
- Change the program name using the keyboard.

You can add a line break for longer program names using the ↵ symbol.

- Once you have changed the program name, select *Save*.

A message will appear on the display confirming that the name has been saved.

- Confirm with *OK*.

The program has now been renamed.

Deleting a Favorite

- Select Favorites .
- Touch the program you want to delete and keep your finger on it until the context menu appears.
- Select Delete.
- Confirm the query with *Yes*.

The program is deleted.

Go to Settings | Factory default | Favorites to delete all Favorites at the same time.

Moving Favorites

- Select Favorites .
 - Touch the program you want to move and keep your finger on it until the context menu appears.
 - Select Move.
- An orange border will appear around the entry.
- Move the program.

The program will now appear in the position you want it in.

Baking

Handling and cooking food correctly is essential for maintaining good health.

Cakes, pizzas, and French fries should be cooked until golden, not dark brown.

Always observe USDA/CFIA food safety guidelines.

Tips for baking

- Set a cooking duration. If used for baking, do not delay the start for too long. Otherwise the cake mixture or dough will dry out, and the raising agents will lose their effectiveness.
- Avoid using bright, thin-walled pans made from a shiny material as they give an uneven or poor browning result. In certain unfavorable conditions, the food will not cook properly.
- Place cakes in rectangular bakeware on the wire rack with the longer side across the width of the oven for optimum heat distribution and even results.
- Line the glass tray with parchment paper before placing chips, croquettes, and similar types of food on it.

Selecting the temperature

- Select the suggested temperature in general.

Choosing a baking temperature higher than those recommended may reduce the cooking time, but will lead to uneven browning and unsatisfactory cooking results.

Selecting the cooking duration

- Check whether the food is cooked shortly before the end of the specified cooking duration. Stick a wooden skewer into the food.

If it comes out clean without any batter/dough on it, the food is done.

Notes on the operating modes

You can find an overview of all the operating modes with their recommended values in “Main and submenus”.

Using Automatic Programs

- Follow the instructions on the display.

Using Convection Bake

You can use any type of bakeware made of heat-resistant material.

Because the blower distributes the heat around the oven cavity straight away, you can use a lower temperature than you would with the Surround  operating mode.

Use this operating mode if you are baking on multiple shelf levels at the same time.

- 1 shelf level: place cakes in baking tins on shelf level 1.
- 1 shelf level: place flat items (e.g., cookies, tray cakes) on shelf level 2.
- 2 shelf levels: depending on the height, place the food on shelf levels 1+3 or 2+3.

Using Surround

Dark metal, enamel, or aluminum bakeware with a matte finish, as well as heat-resistant glass, ceramic, and coated bakeware can be used.

Use this operating mode for cooking traditional recipes. If using an older recipe or cookbook, set the oven temperature 20°F (10°C) lower than that recommended. This will not change the cooking duration.

- Place cakes in baking tins on shelf level 1.
- Place flat items (e.g., cookies, tray cakes) on shelf level 2.

Using Intensive

You can use any type of bakeware made of heat-resistant material.

Use this operating mode for baking cakes with moist toppings.

Do **not** use this operating mode for baking thin cookies.

- Place cakes in baking tins on shelf level 1.

Using Combi Conv Bake

Use heat-resistant baking tins suitable for microwave use (see “Microwave operation – Suitable dishware”), such as heat-resistant glass or ceramic dishes, as these allow microwaves through them.

The Combi Conv Bake  operating mode is particularly suitable for baking dough which requires a longer cooking duration, such as rubbed in, beaten mixtures and yeast recipes.

If you use this operating mode, the cooking duration is shortened.

- Place the glass tray on shelf level 1.
- Place the baking tin on the glass tray.

Tip: Metal tins are less suitable for operating modes which use microwave power because the metal reflects the microwaves. The microwaves only reach the cake from above, which extends the cooking duration. If you use metal tins, place the tin on the glass tray so that it cannot touch the oven walls. If sparks form, do not reuse the tin for operating modes which use microwave power.

Roasting

The wireless food probe will be damaged by the speed oven. Only use the wired food probe in the speed oven.

Always observe USDA/CFIA food safety guidelines.

Tips for roasting

- **Preheating** the oven is only required when roasting beef sirloin and fillet. Preheating is generally not necessary.
- Use a **closed cooking container** for roasting meat, such as a roasting dish. The meat will stay succulent. The oven cavity will also stay cleaner than when roasting on the wire rack. It ensures that enough stock remains for making gravy.
- If you are using a **roasting bag**, follow the instructions on the packaging.
- If you are using the **wire rack** or an **open cooking container** for roasting, you can add a little fat or oil to very lean meat or place a few strips of streaky bacon on the top.
- **Season** the meat and place in the cooking container. Dot with butter or brush with oil or cooking fat. For large lean cuts of meat (4.5–6.5 lbs/2–3 kg) and fatty poultry, add about 1/2 cup (1/8 liter) of water to the dish.

- Do not add too much liquid during cooking as this will hinder the **browning** process. Browning only occurs towards the end of the cooking duration. Remove the lid about halfway through the cooking duration if you want a more intensive browning result.
- At the end of the program, take the food out of the oven, cover it, and leave to **stand** for about 10 minutes. This helps retain the juices when the meat is sliced.
- For a crisp finish, baste **poultry** 10 minutes before the end of the cooking duration with slightly salted water.

Selecting the 🌡️ temperature

- As a general rule, select the temperature given in the corresponding recipe.
- For large pieces of meat, do not choose a temperature that is too high. The roasting process will take longer, but the meat will cook through evenly and the skin or crackling will not be too thick.

Selecting the ⌚ cooking duration

- Check whether the food is cooked shortly before the end of the specified cooking duration.

Tips

- For frozen meat, increase the cooking duration by approx. 10 minutes per lb (20 minutes per kg).
- Frozen meat weighing less than approx. 3.3 lb (1.5 kg) does not need to be defrosted before roasting.

Notes on the operating modes

You can find an overview of all the operating modes with their recommended values in “Main and submenus”.

Use the Bake  operating mode towards the end of the cooking duration to brown the base of the food.



Do not use the Intensive  operating mode for roasting as the juices will become too dark.

Using Automatic Programs

- Follow the instructions on the display.

Using Convection Roast or Auto Roast

These operating modes are suitable for roasting meat, fish, and poultry that needs to be well browned, as well as roast beef and fillet.

The Convection Roast  operating mode allows you to use a lower temperature than you would with the Surround  operating mode, because the heat is immediately distributed throughout the oven cavity.

With the Auto Roast  operating mode, the oven cavity initially heats to the highest temperature in this operating mode for searing. As soon as this temperature has been reached, the oven automatically drops the temperature back down to the preselected cooking temperature (continued roasting temperature).

- For roasting, use dishware with heat-resistant handles such as an oven dish, roasting pan, terracotta dish, or a heat-resistant glass dish.
- Place the wire rack with the food on shelf level 2.

Using Combi Conv Roast or Combi Auto Roast

These operating modes are **not** suitable for roasting delicate cuts of meat such as sirloin joints or fillet. The center would be too well cooked before the exterior is browned.

Use the Combi Conv Roast  operating mode for rapid reheating and cooking of food while browning it at the same time. This operating mode saves the most time and energy.

Use the Combi Auto Roast  operating mode for searing using a high temperature to start with, then continue cooking with a lower temperature.

If you use operating modes which use microwave power, the cooking duration is shortened.

- Dishware must be suitable for use in a microwave oven, must be heat-resistant, and must not have metal lids (see “Microwave operation – Suitable dishware”).
- Place the wire rack together with the glass tray or the glass tray on shelf level 1.

Roasting

Probe

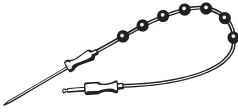

The food probe allows you to monitor the cooking process simply and reliably.

The wireless food probe will be damaged by the speed oven.

Only use the wired food probe in the speed oven.

How it works

The metal tip of the roast probe must be fully inserted into the center of the food all the way to the handle. There is a temperature sensor in the metal tip which measures the core temperature of the food during the cooking process. The rise in the core temperature reflects the extent to which the food is cooked. You can program the core temperature to be lower or higher, depending on whether you want your meat to be rare, medium, or well done.

The maximum core temperature setting is 210°F (99°C).

The cooking time will be similar when cooking with or without the wireless food probe.

When to use the probe

Some automatic programs and Special Modes will prompt you to use the probe.

You can also use the probe with Favorites and with the following operating modes:

- Auto Roast 
- Convection Roast 
- Surround 
- Microwave 
- Combi Auto Roast 
- Combi Conv Roast 

Important usage notes

- You can place the meat in a pot, on the wire rack, or on the glass tray, depending on the operating mode selected.
- The metal tip of the probe must be fully inserted into the center of the food so that the temperature sensor reaches more or less to the core.
- When cooking poultry, insert the metal part into the thickest part of the breast. You can find the thickest part of the breast by pressing the area with your thumb and index finger.
- The metal tip must not touch any bone or be inserted in areas with a lot of fat. Fatty tissue and bones can cause the probe to turn off early.
- When using aluminum foil or roasting bags, insert the probe through the foil/bag into the center of the food. You can also place meat inside the bag or foil with the probe already inserted. Be sure to follow the instructions provided by the manufacturer of the roasting bag or aluminum foil.

Using the probe

- Fully insert the metal tip of the probe into the center of the meat all the way to the handle.

If you are cooking several pieces of meat at the same time, insert the probe into the largest piece of meat.

- Place the food in the oven.

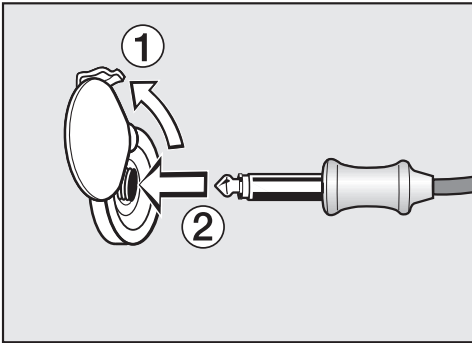

- Insert the plug of the probe into the socket until you feel it engage.
- Close the door.
- Select an operating mode or automatic program.
- Set the temperature and the core temperature if necessary.

Core temperatures cannot be changed for automatic programs.

Follow the instructions on the display.

The cooking program finishes as soon as the core temperature is reached.

⚠ Risk of injury caused by hot surfaces.

The probe can get hot. You could burn yourself on it.

Use pot holders when removing the probe from its socket.

Delaying the start of a cooking program with probe

You can also delay the start of the cooking program to a later time.

- Select **Start at**.

You can estimate approximately when the food will be ready as the duration of the cooking program is about the same as if you were cooking food without using the probe.

You cannot set **Duration** and **Ready at** because the total cooking duration is determined by when the set core temperature is reached.

Time-left display

If the temperature set for a cooking process is above 285°F (140°C), the estimated duration remaining (time left) will appear on the display.

The time left is calculated from the cooking temperature selected, the set core temperature, and the progress of the core temperature as it rises.

The time left first shown is an estimate. As the cooking process continues, the time left is revised continuously, and a more accurate figure is shown.

The time left will be deleted if the cooking temperature or core temperature is changed or if a different operating mode is selected. If the door is opened for a longer time, the time left will be recalculated.

Broiling

 Risk of injury caused by hot surfaces.

If you broil with the door open, the hot air will escape from the oven before it has been cooled by the cooling fan. The control elements will get hot.



Broil with the oven door closed.

Always observe USDA/CFIA food safety guidelines.

Tips for broiling



- Preheating is necessary when broiling. For preheating, select an operating mode which **does not use** microwave power. Preheat the browning/broiling element for approx. 5 minutes with the door closed.
- Quickly rinse meat under cold running water and pat dry. Do not season the meat with salt before broiling, as this will draw out the juices.
- Add a little oil to lean meat if necessary. Do not use other types of fat as they can easily burn and cause smoke.
- Clean fish in the normal way. To enhance the flavor, season with a little salt. You can also drizzle the fish with lemon juice.
- It is generally best to broil on the wire rack.
- To broil, brush the wire rack with oil and then place the food on the wire rack.

Selecting the temperature



Select the temperature for the Convection Broil  and Combi Conv Broil  operating modes.

- As a general rule, select the lower temperature given in the chart. If higher temperatures are used than those specified, the meat will brown on the outside, but will not be properly cooked through.

Selecting the broiling setting

Select between levels 1–3 for the Maxi Broil  and Combi Broil  operating modes.

- If you are broiling thicker foods further away from the broiling element, select **level 1**.
- If you desire a lighter, golden finish, on gratins for example, select **level 2**.
- If you are quickly broiling thinner foods closer to the broiling element, select **level 3**.

Set the microwave power level , the broiling level , and the cooking duration.

Selecting the cooking duration

- Broil thinner cuts of meat/slices of fish for approx. 6–8 minutes per side. It is best to broil food of a similar thickness at the same time so that the cooking durations do not vary too much.
- Broil thicker pieces for about 7–9 minutes per side.
- When broiling rolled meat, allow approx. 10 minutes per 1/2" (1cm) diameter.
- Check whether the food is cooked shortly before the end of the specified cooking duration.

Tip: If the surface of a thicker cut of meat is browned but the center is still raw, move the food to a lower level or reduce the temperature and continue broiling. This will stop the surface from becoming too dark.

Notes on the operating modes

You can find an overview of all the operating modes with their recommended values in “Main and submenus”.

The plastic on the probe can melt at very high temperatures.

Do not use the probe when using the broiling operating modes.

Do not store the probe in the oven compartment when it is not being used.

If you use operating modes which use microwave power, the cooking duration is shortened.

Using Convection Broil or Combi Conv Broil

These operating modes are suitable for broiling thicker food, such as chicken.

We generally recommend a temperature setting of 425°F (220°C) for thinner types of food and 350–400°F (180–200°C) for thicker cuts.

- Place the wire rack on shelf level 1 or 2 depending on the height of the food.

Using Maxi Broil or Combi Broil

These operating modes are suitable for broiling thin cuts of meat and browning food.

- Place the wire rack on shelf level 2 or 3 depending on the height of the food.

Cleaning and care of the drawer



Risk of injury due to hot surfaces.

The drawer gets hot during operation. You could burn yourself on the drawer's heater elements, oven compartment, or accessories. Allow the heater elements, oven compartment, and accessories to cool before manual cleaning.



Danger of injury!

The steam from a steam cleaning appliance could reach live electrical components and cause a short circuit.

Do not use a steam cleaner to clean the drawer.



Risk of damage!

Unsuitable cleaning agents and detergents can damage the surfaces.

Only use common household liquid dish soap to clean the appliance.

All surfaces could be discolored or damaged if unsuitable cleaning agents are used. The oven front is particularly susceptible to damage from oven cleaners.

All surfaces are susceptible to scratching. Scratches on glass can lead to breakage in some circumstances.

Remove all cleaning agent residues immediately.

Unsuitable cleaning agents

To avoid damaging the surfaces of your appliance, do not use:

- cleaning agents containing soda, ammonia, acids, or chlorides
- cleaning agents containing descaling agents
- Abrasive cleaning agents, e.g., powder cleaners and cream cleaners
- solvent-based cleaning agents
- stainless steel cleaning agents
- dishwasher cleaning agents
- oven sprays
- glass cleaners
- hard, abrasive sponges and brushes, e.g., pot scourers
- sharp metal scrapers

Clean and dry the entire appliance after each use. Allow the appliance to cool down first.

Cleaning the appliance front and interior

The On/Off button must remain free of grime and liquids. Failure to keep the sensor button clean may cause it to become unresponsive or to switch uncontrollably.

- Remove normal soiling immediately using a clean sponge with warm water and liquid dish soap applied with a clean, damp microfiber cloth.
- Make sure to wash away any residues left by the cleaning agents using clean water.
This is particularly important on surfaces treated with PerfectClean enamel, as cleaner residues can negatively affect their non-stick properties.
- After cleaning, dry the surfaces with a soft cloth.

Cleaning the non-slip mat

Do not clean the non-slip mat in the dishwasher or washing machine. Never place it in the oven to dry!

- Remove the non-slip mat for cleaning.
- Clean the mat by hand only, using warm water and a small amount of liquid dish soap, and then dry using a cloth.
- Do not return the non-slip mat to the warming drawer until it is completely dry.

Cleaning and care of the oven

 Danger of injury caused by hot surfaces.

The oven gets hot during operation. You could burn yourself on the heater elements, oven cavity, or accessories.

Allow the heater elements, oven cavity, and accessories to cool before manual cleaning.

 Risk of injury due to electric shock.

The steam from a steam cleaning appliance could reach live electrical components and cause a short circuit.

Never use a steam cleaner for cleaning.

All surfaces could be discolored or damaged if unsuitable cleaning agents are used. The oven front is particularly susceptible to damage from oven cleaners.

All surfaces are susceptible to scratching. Scratches on glass can lead to breakage in some circumstances.

Remove all cleaning agent residues immediately.

Stubborn soiling may damage the oven.

Once the oven has cooled, clean the oven cavity, the inside of the door, and the door seal. Waiting too long to clean the oven will make it much more difficult to clean.

Operating a damaged oven can result in microwave leakage and present a hazard to the user.

Check the door and door seal for any sign of damage. If any damage is seen, the oven should not be used again. Contact Miele.

Unsuitable cleaning agents

To avoid damaging the surfaces of your appliance, do not use:

- cleaning agents containing soda, ammonia, acids, or chlorides
- cleaning agents containing descaling agents on the front
- abrasive cleaning agents (e.g., powder cleaners and cream cleaners)
- solvent-based cleaning agents
- stainless steel cleaning agents
- dishwasher cleaners
- glass cleaners
- cleaning agents for ceramic glass cooktops
- hard, abrasive brushes or sponges (e.g., pot scourers, brushes, or sponges which have been previously used with abrasive cleaning agents)
- eraser sponges
- sharp metal scrapers
- steel wool
- spot cleaning with mechanical cleaning agents
- stainless steel spiral pads

Cleaning and care of the oven

If soiling is allowed to sit for any length of time, it may become impossible to remove. If items are used frequently without being cleaned, it may become very difficult to clean them.

It is therefore best to remove any soiling immediately.

Only the glass tray is dishwasher proof.

Tip: Soiling caused by spilled fruit juices and cake mixtures is best removed while the oven is still warm. Use caution and make sure the oven is not too hot.

To make it easier to clean the oven:

- Lower the browning/broiling element.
- To neutralize odors in the oven compartment, put a container of water with some lemon juice in the oven and heat for a few minutes.

Removing normal soiling

Moisture inside the oven can cause damage.

Do not use too much water on the cloth or sponge and do not let water or any other liquid find its way into any oven cavity openings.

Removing normal soiling

- Remove normal soiling immediately with warm water, liquid dish soap, and a clean sponge or a clean, damp microfiber cloth.
- Remove all cleaning agent residues thoroughly with clean water. This is particularly important for any parts with a PerfectClean finish, as cleaning agent residues will impair the non-stick function.
- After cleaning, wipe the surfaces dry using a soft cloth.

Cleaning the probe

Do not put the probe into water or clean it in the dishwasher as this will damage it.

Clean the probe with a damp cloth only.

Cleaning and care of the oven

Removing stubborn soiling

Spilt fruit and roasting juices may cause lasting discoloration or matte patches on surfaces. This discoloration will not affect the properties of the surface finish. Do not attempt to remove these stains. Clean them following the instructions given here.

- Moisten stubborn soiling with a solution of hot water and washing-up liquid and leave to soak for a few minutes.
- If necessary, the scouring pad on the back of a washing-up sponge can be used to remove the soiling after the soaking time.

Using oven cleaners

- Very stubborn soiling on PerfectClean surfaces can be cleaned using Miele Oven Cleaner. This cleaner must only be applied to cold surfaces.

If the oven spray gets into gaps and openings, a strong odor is generated during subsequent cooking processes.

Do not spray the oven cleaner onto the ceiling of the oven.

Do not spray the oven cleaner into the gaps and openings of the oven cavity walls and rear wall.

- Leave the oven cleaner to work according to the instructions on the packaging.

Oven cleaners from other manufacturers must only be used in a cold oven and not left on for longer than a maximum of 10 minutes.

- If necessary, you can use the scouring pad on the back of a non-scratching dish sponge to remove the soiling after the holding time.
- Remove all cleaning agent residues thoroughly with clean water.
- Dry all surfaces with a soft cloth.

Cleaning and care of the oven

Lowering the browning/broiling element

If the ceiling of the oven is badly soiled, the browning/broiling element can be lowered to make cleaning easier. Clean the ceiling of the oven regularly with a damp cloth or a dish sponge.

 **Danger of injury caused by hot surfaces.**

The oven gets hot during operation. You could burn yourself on the heater elements, oven cavity, or accessories.

Allow the heater elements, oven cavity, and accessories to cool before manual cleaning.

The oven cavity floor can be scratched by the falling nut. Place a cloth or similar item over the oven floor to protect it.

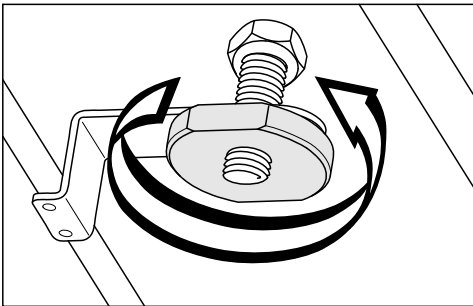

- Unscrew the nut.

Take care not to damage the browning/broiling element. Do not use force when lowering the browning/broiling element.

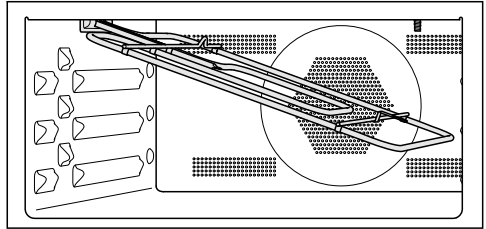

- Carefully lower the browning/broiling element.

The liner on the ceiling of the oven can be damaged.

Do not use the abrasive side of the dishwashing sponge to clean the ceiling of the oven.

The LED on the ceiling of the oven can be damaged.

Do not clean the LED if possible.



- Clean the ceiling of the oven with a damp cloth or a soft sponge.
- After cleaning, raise the browning/broiling element gently back up again.
- Replace the nut and tighten it securely.

Frequently asked questions





Many malfunctions and faults that can occur in daily operation can be easily remedied. You can save time and money in many cases, as you do not need to contact Miele Customer Service.

Information to help you rectify faults yourself can be found at www.miele.com/service.

The following tables are designed to help you to find the cause of a malfunction or a fault and to resolve it.

| Problem | Possible cause and solution |
|--|---|
| The drawer does not heat up. | There is no power to the range. ■ Check if the breaker has tripped. If it has, contact a qualified electrician or Miele Customer Service. |
| The food is not hot enough. | The  Keeping food warm operating mode is not selected. ■ Set the correct operating mode. |
| | The temperature setting is too low. ■ Select a higher temperature. |
| | The air vents are covered. ■ Make sure that air can circulate freely. |
| The food is too hot. | The  Keeping food warm operating mode is not selected. ■ Set the correct operating mode. |
| | The temperature setting is too high. ■ Select a lower temperature. |
| The dishware is not hot enough. | The  Warming dishware/plates operating mode was not selected. ■ Set the correct operating mode. |
| | The temperature setting is too low. ■ Select a higher temperature. |
| | The air vents are covered. ■ Make sure that air can circulate freely. |
| | The dishware has not been warmed long enough. ■ The warming time for dishware is affected by a number of factors (see “Operating the drawer – Heating dishware”). |







Frequently asked questions

| Problem | Possible cause and solution |
|---|---|
| The dishware is too hot. | The  Warm Dishes/Plates or  Warm Cups/Glasses operating mode was not selected. <ul style="list-style-type: none"> ■ Set the correct operating mode. |
| | The temperature setting is too high. <ul style="list-style-type: none"> ■ Select a lower temperature. |
| Noise occurs during operation | The noise is caused by the fan, which distributes the heat evenly throughout the drawer. The fan runs at intervals in the  Keep Warm and  Slow Roasting operating modes. This is not a fault. |
| The display is dark. | You have selected the Time Display Off setting. When the oven is turned off, the time-of-day display is dark. <ul style="list-style-type: none"> ■ As soon as the oven is turned on, the main menu will appear. If you want the time of day to be displayed constantly, select the Time Display On setting. |
| | There is no power to the oven. <ul style="list-style-type: none"> ■ Check that the oven's electrical plug is correctly inserted in the socket and that the circuit breaker has been switched to on. ■ Check if the breaker has tripped. If it has, contact a qualified electrician or Miele Customer Service. |
| The audible signal does not sound. | The audible signals are deactivated or set at too low a volume. <ul style="list-style-type: none"> ■ Turn on the audible signals or increase the volume with Settings Volume Buzzer Tones. |
| The oven does not heat up. | Demo mode is activated. You can select menu options on the display and sensor buttons, but the oven heating does not work. <ul style="list-style-type: none"> ■ Deactivate Demo mode by selecting Settings Showroom Program Demo Mode Off. |

Frequently asked questions

| Problem | Possible cause and solution |
|--|---|
| <p>You cannot start a cooking process.</p> | <p>If you are cooking with microwave power, the door may be open.</p> <ul style="list-style-type: none"> ■ Check whether the door is closed properly. |
| | <p>If you are cooking with microwave power, the power level or cooking duration is not selected.</p> <ul style="list-style-type: none"> ■ Check whether a microwave power level and a duration have been selected. |
| | <p>If you are cooking with an operating mode which uses microwave power, not all of the required settings have been entered.</p> <ul style="list-style-type: none"> ■ Check whether a microwave power level, a cooking duration, and a temperature have been selected. |
| <p>The sensor buttons or the proximity sensor do not respond.</p> | <p>You have selected the Display QuickTouch Off setting. When this is activated, the sensor buttons and proximity sensor do not respond when the oven is turned off.</p> <ul style="list-style-type: none"> ■ As soon as the oven is turned on, the sensor buttons and the proximity sensor will respond. If you want the sensor buttons and the proximity sensor to respond even when the oven is turned off, select the Display QuickTouch On setting. |
| | <p>The settings for the proximity sensor are turned off.</p> <ul style="list-style-type: none"> ■ Change the settings for the proximity sensor by selecting Settings MotionReact. |
| | <p>The proximity sensor is defective.</p> <ul style="list-style-type: none"> ■ Contact Miele Customer Service. |
| | <p>The oven is not connected to the domestic electrical supply.</p> <ul style="list-style-type: none"> ■ Make sure that the plug is correctly inserted in the socket and that the socket switch has been switched to on. ■ Check if the breaker has tripped. If it has, contact a qualified electrician or Miele Customer Service. |
| | <p>If the display does not respond, there is a fault with the controls.</p> <ul style="list-style-type: none"> ■ Touch and hold the  On/Off button until the display turns off and the oven restarts. |

Frequently asked questions

| Problem | Possible cause and solution |
|---|--|
| System Lock  appears on the display when the oven is turned on. | <p>The  system lock is activated.</p> <ul style="list-style-type: none"> ■ You can deactivate the system lock for a cooking program by touching the  symbol for at least 6 seconds. ■ If you want to permanently deactivate the system lock, select the <i>Safety System Lock  Off</i> setting. |
| Power failure -Program cancelled appears on the display. | <p>There has been a brief power failure. This has caused the current cooking process to stop.</p> <ul style="list-style-type: none"> ■ Turn the oven off and then back on again. ■ Restart the cooking process. |
| 12:00 appears on the display. | <p>There was a power failure for more than 150 hours.</p> <ul style="list-style-type: none"> ■ Reset the date and time. |
| Maximum operating duration reached appears on the display. | <p>The oven has been operating for an unusually long time. This has triggered the safety shut-off.</p> <ul style="list-style-type: none"> ■ Confirm with <i>OK</i>. <p>The oven is now ready to use again.</p> |
| Fault and a fault code not listed here appear on the display. | <p>A fault has occurred that you cannot resolve.</p> <ul style="list-style-type: none"> ■ Contact Miele Customer Service. |
| If the door is opened during a cooking process using the Microwave  operating mode, the oven stops making noise. | <p>This is not a fault. If the door is opened during a cooking process using the Microwave  operating mode, the door contact switch will switch off microwave power and switch the cooling fan to a lower speed.</p> |
| You can hear a noise after a cooking program. | <p>The cooling fan remains turned on after a cooking program (see “Settings – Cooling fan run-on”).</p> |

Frequently asked questions

| Problem | Possible cause and solution |
|--|--|
| <p>An abnormal sound can be heard when the oven is operating in microwave mode.</p> | <p>A metal dish has been used during a cooking process using microwave power.</p> <ul style="list-style-type: none"> ■ Check if there are sparks caused by using metal dishes (see “Microwave operation – Suitable dishware”). |
| | <p>The food was covered with aluminum foil during a cooking process using microwave power.</p> <ul style="list-style-type: none"> ■ If it is, remove the foil. |
| | <p>The wire rack was used during a cooking process using microwave power.</p> <ul style="list-style-type: none"> ■ Always use the glass tray when using the oven with microwave power. |
| <p>The oven has turned itself off.</p> | <p>To save power, the oven turns off automatically if a button is not pressed after a certain amount of time or after a cooking program has ended.</p> <ul style="list-style-type: none"> ■ Turn the oven back on. |
| <p>The cake/cookies are not baked properly.</p> | <p>A different temperature than that given in the recipe was used.</p> <ul style="list-style-type: none"> ■ Select the temperature required for the recipe. |
| | <p>The ingredient quantities are different from those given in the recipe.</p> <ul style="list-style-type: none"> ■ Check if you have amended the recipe. The addition of more liquid or more eggs will make a wetter mixture which will take longer to cook. |
| <p>The browning is uneven.</p> | <p>You selected the wrong temperature or shelf level.</p> <ul style="list-style-type: none"> ■ There will always be a slight unevenness. If browning is very uneven, check whether you selected the correct temperature and shelf level. |
| | <p>The material or color of the bakeware is not suitable for the operating mode selected. Light-colored, shiny, or thin-walled pans are less suitable. These reflect the oven's heat, which means that the heat does not penetrate to the food effectively, resulting in uneven or poor browning.</p> <ul style="list-style-type: none"> ■ Dark, matte baking pans are best for baking. |

Frequently asked questions

| Problem | Possible cause and solution |
|--|---|
| <p>The food is not sufficiently heated or is not cooked at the end of a set duration when using the Microwave  operating mode.</p> | <p>Check whether the cooking process using microwave power has been interrupted and has not been restarted.</p> <ul style="list-style-type: none"> ■ Restart the cooking process to ensure the food is heated or cooked properly. <hr/> <p>When cooking or reheating with microwave power, the time set was too short.</p> <ul style="list-style-type: none"> ■ Check that the correct duration is selected for the microwave power level. The lower the microwave power level, the longer the duration required. |
| <p>Food has cooled down too quickly after being reheated or cooked using microwave power.</p> | <p>In the microwave, food begins to cook from the outside first, the inside of the food relying on the slower conduction of heat. If food is cooked at a high microwave power level, it is possible that the heat may not have reached the center of the food, so it is hot on the outside but cold in the centre. During the standing time, the heat is transferred to the center of the food.</p> <ul style="list-style-type: none"> ■ When reheating food with different densities, such as with menu cooking, it is sensible to start with a low microwave power level and select a longer reheating duration. |
| <p>The oven interior lighting turns off after a short time.</p> | <p>You have selected the Lighting “On” for 15 seconds setting.</p> <ul style="list-style-type: none"> ■ If you want the oven interior lighting to remain on during the entire cooking program, select the Lighting On setting. |
| <p>The oven interior lighting is off or does not turn on.</p> | <p>You have selected the Lighting Off setting.</p> <ul style="list-style-type: none"> ■ Press the <i>Light</i> sensor button to turn the oven interior lighting on for 15 seconds. ■ If required, select the Lighting On or “On” for 15 seconds setting. <hr/> <p>The oven interior lighting is faulty.</p> <ul style="list-style-type: none"> ■ Contact Miele Customer Service. |

Customer Service

Information to help you rectify faults yourself and about Miele spare parts can be found at www.miele.com/service.

Contact in the event of a fault

In the event of a fault which you cannot remedy yourself, please contact your Miele dealer or Miele Customer Service.

You can book a Miele Service Call online at www.miele.com/service.

Contact information for Miele Customer Service can be found at the end of this document.

Please quote the model identifier and serial number of your appliance (SN) when contacting Miele Customer Service. Both pieces of information can be found on the data plate.

This information is given on the data plate, which is visible on the front frame of the oven when the door is fully open.

Appliance warranty and product registration

You can register your product and/or view the manufacturer's warranty terms and conditions for Miele appliances and vacuum cleaners at www.mieleusa.com.

Disposal of the packing material

The cardboard box and packing materials protect the appliance during shipping. They have been designed to be biodegradable and recyclable.

Ensure that any plastic wrappings, bags, etc. are disposed of safely and kept out of the reach of children.
Danger of suffocation!

Disposal of your old appliance

Electrical and electronic appliances contain valuable materials. They also contain certain substances, compounds and components which were essential for the proper functioning and safe use of the equipment. Handling these materials improperly by disposing of them in your household waste can be harmful to your health and the environment. Therefore, please do not dispose of your old appliance with regular household waste and follow local regulations on proper disposal.



Consult with local authorities, dealers or Miele in order to dispose of and recycle electrical and electronic appliances. Miele assumes no responsibility for deleting any personal data left on the appliance being disposed. Please ensure that your old appliance is kept away from children until removal. Observe safety requirements for appliances that may tip over or pose an entrapment hazard.

Declaration of conformity

Supplier's Declaration of Conformity 47 CFR § 2.1077 Compliance Information

Microwave Function

Unique Identifier: Miele Model:
HR 1954-3 DF, HR 1955-3 DF or
HR 1956-3 DF

Responsible Party

Miele, Inc.
National Headquarters
9 Independence Way
Princeton, NJ 08540
Phone: 800-843-7232
Fax: 609-419-4298
www.mieleusa.com

FCC Compliance Statement: This device complies with Part 18 of the FCC Rules.

Regarding radiological health this product complies with DHHS rules 21 CFR Subchapter J.

IC Compliance Statement:

This device complies with
CAN ICES-001 (B) / NMB-001 (B)

Radio Modules

This device contains the following food probe radio module:

| | |
|----------------------------|--------------------------|
| FCC ID | SSVNAEPI02 |
| IC ID | 5669B-NAEPI02 |
| Frequency band | 2.401 GHz – 2.482 GHz |
| Maximum transmitting power | 120 mW |

Declaration of conformity

or alternatively, the following food probe radio module:

| | |
|----------------------------|--------------------------|
| FCC ID | SSVNAEPI03 |
| IC ID | 5669B-NAEPI03 |
| Frequency band | 2.401 GHz – 2.482 GHz |
| Maximum transmitting power | 120 mW |

and the following WiFi modules:

| | |
|----------------------------|--------------------------|
| FCC ID | 2AC7Z-EK057 |
| IC ID | 21098-EK057 |
| FCC ID | 2ACUW-EK037 |
| IC ID | 5669C-EK037 |
| Frequency band | 2.412 GHz – 2.462 GHz |
| Maximum transmitting power | < 0.2 W |

Compliance Statement

This device complies with Part 15 of the FCC Rules and contains licence-exempt transmitter(s)/receiver(s) that comply with Innovation, Science and Economic Development Canada's licence-exempt RSS Standard(s). Operation is subject to the following two conditions:

- (1) this device may not cause harmful interference, and
- (2) this device must accept any interference received, including interference that may cause undesired operation.

The construction of the device assures that the FCC/IC exposure limits are verifiably met using the integrated radio modules.

Warning!

Any changes or modifications to this unit not expressly approved by the party responsible for compliance could void the user's authority to operate the equipment.

Copyrights and licenses

Miele uses their own and third party software which is not subject to any so-called open source license for the operation and control of the device/appliance. This software/these software components are protected by copyright. The copyright powers of Miele and third parties have to be respected.

Furthermore, this device/appliance contains software components which are distributed under open source license conditions. Please refer to [Settings | Legal information | Open source licenses](#) in the device/appliance for the open source components contained therein, together with the corresponding copyright notices, copies of the licensing conditions valid at the time, and any further information. The liability and warranty provisions of the open source licensing conditions as stated therein apply only in relation to the respective rights holders.

In particular, the device/appliance contains software components licensed by the copyright holders under the GNU General Public License, Version 2, or the GNU Lesser General Public License, Version 2.1. For a period of at least 3 years from the date of purchase or delivery of the device/appliance respectively, Miele offers to provide you or third parties with a machine-readable copy of the source code of the Open Source components contained in the device/appliance and licensed under the terms of the GNU General Public License, Version 2, or the GNU Lesser General Public License, Version 2.1, on a data carrier (CD-ROM, DVD or USB stick). Please contact us via e-mail (info@miele.com) or the below postal address and state the product name, the serial number and the date of purchase to obtain this source code.

Miele & Cie. KG
Open Source
GTZ/TIM
Carl-Miele-Straße 29
33332 Gütersloh

Please note the limited warranty in favor of the rights holders under the terms of the GNU General Public License, Version 2, and the GNU Lesser General Public License, Version 2.1:

This program is distributed in the hope that it will be useful, but WITHOUT ANY WARRANTY, without even the implied warranty of MERCHANTABILITY of FITNESS FOR A PARTICULAR PURPOSE. See the GNU General Public License and GNU Lesser General Public License for more details.

Copyrights and licenses for the communication module

For the purpose of operating and controlling the communication module, Miele uses proprietary or third-party software that is not covered by open source licensing terms. This software/ these software components are protected by copyright. The copyrights held by Miele and third parties must be respected.

This communication module contains software components which are distributed under open source license conditions. The open source components contained in the appliance along with the corresponding copyright notices, copies of the licensing terms valid at the time, and any additional information can be accessed locally via *http://<IP address>/Licenses*. The liability and warranty arrangements for the open source licenses displayed in this location only apply in relation to the respective rights holders.

**Please have the model and serial number
of your appliance available when
contacting Customer Service.**

U.S.A.

Miele, Inc.

National Headquarters

9 Independence Way
Princeton, NJ 08540
www.mieleusa.com

Customer Support

Phone: 888-99-MIELE (64353)
info@mieleusa.com

International Headquarters

Miele & Cie. KG
Carl-Miele-Straße 29
33332 Gütersloh
Germany

Canada

**Importer
Miele Limited**

Headquarters and Miele Centre

161 Four Valley Drive
Vaughan, ON L4K 4V8
www.miele.ca

Customer Care Centre

Phone: 1-800-565-6435
905-532-2272
customercare@miele.ca

HR 1954-3 DF, HR 1955-3 DF, HR 1956-3 DF

en-US, CA

M.-Nr. 11 919 070 / 07