



20.8 cu.ft. French door bottom mount refrigerator



MFF208WFD | MFF208SSFD

Congratulations on the purchase of your new Marathon Refrigerator!

To activate your Warranty, please register your appliance at www.stirlingmarathon.com or by completing and mailing the enclosed Warranty Registration Card. We are confident you will have years of hassle-free enjoyment and ask that you please retain the Use & Care Guide for future reference and your safety.

Before installing please, read your Use & Care Guide carefully and pay special attention to the Safety & Warning information outlined in the following pages.

For immediate assistance: 1-844-309-9777
www.stirlingmarathon.com

OVERVIEW

1. Temperature Control Panel & LED Light
2. Wine Rack
3. Freezer Door Shelf
4. Refrigerator Adjustable Door Bin
5. Crispers
6. Freezer Drawer



Note: Above picture is for reference only. The actual appliance maybe slightly different.

Installation

Installing Your Refrigerator

- This appliance is designed to be free-standing only, and should not be recessed or built-in.
- **This unit is not designed for use in a garage or any other outside installation**
- Ambient temperature below 50°F (10°C) or above 85°F (29.4°C) will hinder the performance of this appliance.
- Avoid locating the refrigerator in moist areas.
- Locate the refrigerator away from direct sunlight and sources of heat (stove, heater, radiator, etc.).
- Direct sunlight may affect the acrylic coating and heat sources may increase electrical consumption.
- Select a location with enough space for the refrigerator doors to open easily;
- Select a location with level (or nearly level) flooring;
- Allow sufficient space to install the refrigerator on a flat surface;
- Allow clearance to the right, left, back and top when installing. This will help reduce power consumption and keep your energy bills lower.

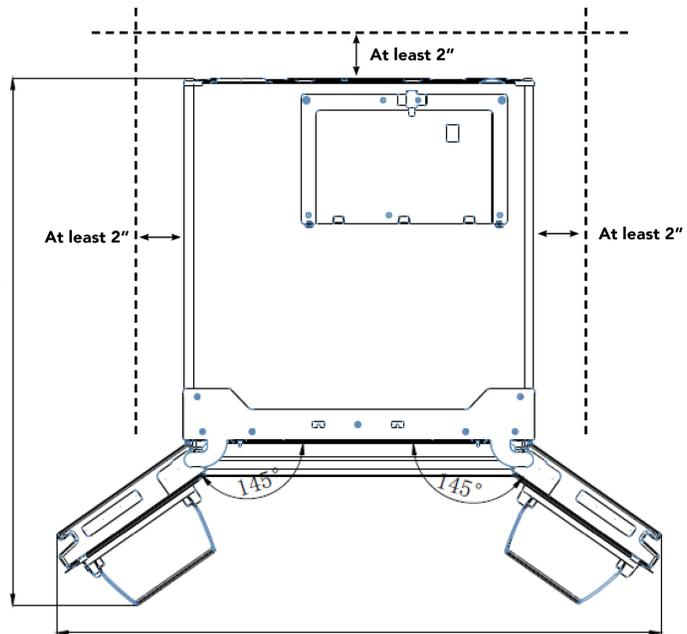
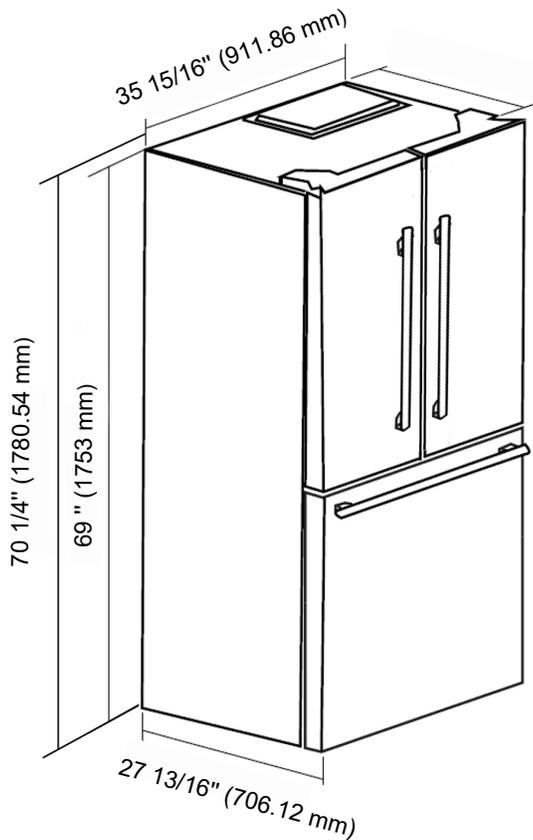

* The above figures are a guideline for installation purposes. The actual dimensions of the unit may vary slightly.

Levelling the Refrigerator

To do this adjust the two levelling feet at front of the unit.
If the unit is not level, the doors and magnetic seal alignments will not be covered properly.

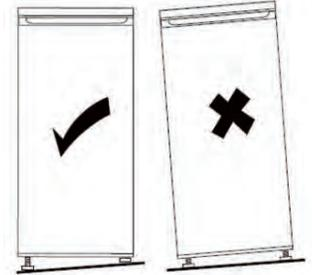

When the refrigerator stays in the packing box, plastic feet are in tightened state. After carrying it out from the packing box for placement, please make sure to adjust two front plastic feet until the height is suitable; just adjust two plastic feet with a wrench or directly by hand.

Plastic feet and rear rollers must touch the ground to prevent the refrigerator from movement, vibration or noise.

When moving the refrigerator, adjust plastic feet counterclockwise to keep them off the ground, and then push the refrigerator gently to move it.

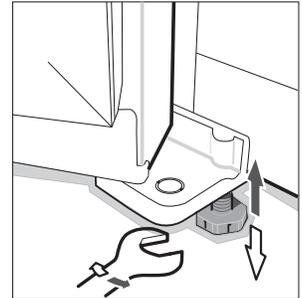

Temperature Control

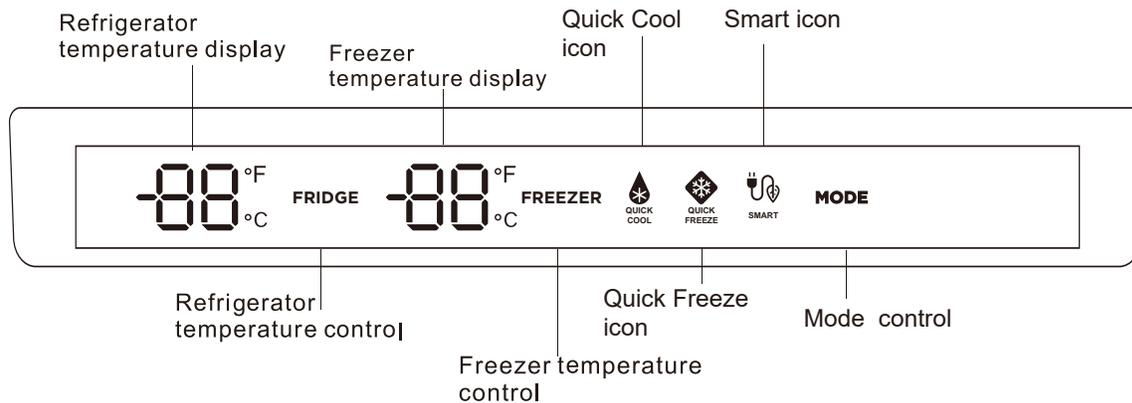

Setting the Temperature Control

Your unit has one control for regulating the temperature. The temperature control is located on the outside of the refrigerator compartment door.

The default temperature is displayed in Fahrenheit when the unit is first powered on. Press and hold the "MODE" button 5 seconds, to switch between °C and °F. Other buttons use the same method to switch between two modes.

Set temperature range: Celsius degree mode

1. Fridge temperature range: 2-8 °C (Default value 5 °C)
2. Freezer temperature range: -23-15 °C (Default value -18 °C)

Set temperature range: Fahrenheit degree mode

1. Fridge temperature range: 32-46 °F (Default value 41 °F)
2. Freezer temperature range: -10-5 °F (Default value 0 °F)

- The first time you turn the unit on, the unit will start at the factory-set default temperature, which is 41°F (5°C) in the refrigerator compartment and 0°F (-18°C) in the freezer compartment.
- The first time you turn the unit on, adjust the temperature in the refrigerator compartment to 37°F (3°C) and run for at least 4 hours before placing food inside. This will ensure that the freezer compartment is thoroughly chilled and the refrigerator compartment is stabilized before food is placed inside. Then adjust the temperature setting to your desired setting.
- To adjust the temperature in each zone, press the appropriate zone button, and the selected zone will flash on and off. The temperature will change according to the pre-set temperatures as shown below. You will hear a bell chime with each press of the control panel buttons.

Temperature Control

PRE-PROGRAMMED FUNCTIONS

QUICK FREEZE MODE



This mode will quickly drop in temperature when storing large amounts of warm or room-temperature foods in the freezer.

The unit will remain in FAST FREEZE mode for 24 hours or until the temperature reaches -10°F or -23°C and will then return to the original setting, or until the function is turned off at the control panel. FAST COOL and FAST FREEZE can be run simultaneously.

To enable the QUICK FREEZE mode, press the feature button until the QUICK FREEZE icon is illuminated. The icon will remain illuminated when activated.

To disable the QUICK FREEZE mode, press the function button until the FAST FREEZE icon is turned off.

FAST COOL MODE



This mode will set the refrigerator temperature to 35°F (0°C) for quick drop in temperature when storing large amounts of warm or room temperature foods in the refrigerator. The unit will remain in FAST COOL mode for 2 hours and 30 minutes or until the temperature reaches 32°F or 0°C and will then return to the original setting, or until the function is turned off at the control panel. Both FAST COOL and FAST FREEZE can be run together at the same time.

To enable the FAST COOL mode, press the feature button until the FAST COOL icon is illuminated. The icon will remain illuminated when activated.

To disable the FAST COOL mode, press the function button until the FAST COOL icon is turned off.

SMART MODE



Use this mode when leaving for long periods of time, where you will remove the large majority of the refrigerator contents but leave contents in the freezer.

Smart mode will automatically set the refrigerator section to 41°F (5°) and the freezer section to 0°F or -18°C . The unit will remain in SMART MODE until the feature is deactivated at the control panel.

To enable VACATION mode, press the feature button until the VACATION icon is illuminated. The icon will remain illuminated when activated.

To disable VACATION mode, press the function button until the VACATION icon is turned off.

Daily Use

Hints for storage of frozen food

To obtain the best performance from this appliance, you should:

- Make sure that the commercially frozen foodstuffs were adequately stored by the retailer.
- Be sure that frozen foodstuffs are transferred from the food store to the freezer in the shortest possible time.
- Do not open the door frequently or leave it open longer than necessary.
- Once defrosted, food deteriorates rapidly and cannot be refrozen.
- Do not exceed the storage period indicated by the food manufacture.

Hints for refrigeration

To obtain the best performance:

- Do not store warm food or evaporating liquids in the refrigerator.
- Cooked foods, cold dishes, etc. These should be covered and may be placed on any shelf.
- Fruit and vegetables: these should be thoroughly cleaned, dried, and place in the crisper drawer(s).
- Butter and cheese: These should be placed in airtight containers or wrapped in aluminum foil or polythene bags to exclude as much air as possible.
- Milk bottles: these should have a cap and should be stored in the balconies on the door.
- Bananas, potatoes, onions and garlic, if not packed, must not be kept in the fridge.

Cleaning

For hygienic reasons the appliance interior, including interior accessories, should be cleaned regularly.



Caution! The appliances may not be connected to any power supply during cleaning. Danger of electrical shock! Before cleaning switch the appliance off and remove the plug from the outlet, or switch off the circuit breaker/fuse. Never clean the appliance with a steam cleaner. Moisture could accumulate in electrical components, danger of electrical shock! Hot vapours can lead to the damage of plastic parts. The appliance must be dry before it is placed back into service.

Important! Ethereal oils and organic solvents can attack plastic parts, e.g. lemon juice or the juice from an orange peel, butyric acid, a cleaner that contains acetic acid.

- Upon installation of your new appliance, it is recommended that it be cleaned thoroughly.
- Wash the inside with a damp warm cloth soaked in lukewarm water and baking soda solution. The solution should be about 2 tablespoons of baking soda to a quart of water.
- Be sure to keep the door gasket (seal) clean to keep the unit running efficiently.
- The outside of the refrigerator should be cleaned with mild detergent and warm water.
- Dry the interior and exterior with a soft cloth.
- To keep the inside sanitary without odor or dirty, regular cleaning required at least once a month.
- Do not allow such substances to come into contact with the appliance parts.
- Do not use any abrasive cleaners.



Daily Use

Optional Ice Maker (sold separately)

Your Marathon refrigerator is “ice maker ready” (ice maker sold separately). For suggested models please contact: customerservice@stirlingmarathon.com



Adjustable Glass Shelves

The walls of the refrigerator are equipped with a built-in of runners so that the shelves can be easily positioned as desired.

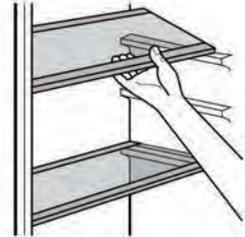

Adjusting the Door Bins

To permit storage of food package various sizes, the door balconies can be placed at different heights. To make these adjustments proceed as follows: gradually pull the bin in the direction of the arrows until it the bin in the comes free, then reposition as required.

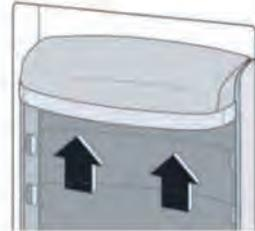

Important Warning

- ⚠ Keep ventilation openings, in the appliance enclosure or built-in structure, clear of obstruction. Do not use mechanical devices or other means to accelerate the defrosting process, other than those recommended by the manufacturer.
- ⚠ Do not change or damage the refrigerant circuit.
- ⚠ Do not store explosive substances such as aerosol cans with a flammable propellant in this appliance.
- ⚠ During transportation and installation of the appliance, be certain that none of the components of the refrigerant circuit have become damaged.
- ⚠ It is dangerous to alter the specifications or modify this product in any way.
- ⚠ Any damage to the cord may cause a short circuit, fire and/or electric shock.
- ⚠ This appliance is intended to be used in residential household, office or light commercial applications such as Hotels and College Dorms.
- ⚠ All electrical components (plug, power cord, compressor and, etc.) must be replaced by a certified service agent or qualified service personnel.
- ⚠ The refrigerant contained within the compressor of the appliance is isobutene (R600a) which is environmentally friendly but flammable.
- ⚠ Make sure that the power cord is not crushed or damaged at the back of the appliance. A crushed or damaged power cord may overheat and cause a fire.
- ⚠ The power cord must not be lengthened.
- ⚠ Make sure that you can come to the power cord of the appliance.
- ⚠ Do not disconnect from electrical outlet by pulling the power cord.
- ⚠ If the electrical outlet is loose, do not insert the power cord. There is a risk of electric shock or fire.
- ⚠ This appliance is heavy. Care should be taken when moving it.
- ⚠ Do not remove or touch items from the freezer compartment if your hands are damp/wet, as this could cause skin abrasions or frost/freezer burns.
- ⚠ Avoid prolonged exposure of the appliance to direct sunlight.



Locate the refrigerator away from direct sunlight and sources of heat (stove, heater, radiator, etc.). Direct sunlight may affect the acrylic coating and heat sources may increase electrical consumption. Ambient temperature below 50°F (10°C) or above 85°F (29.4°C) will hinder the performance of this appliance. **This unit is not designed for use in a garage or any other outside installation.**



Troubleshooting

You can solve many common refrigerator problems easily, saving you the cost of a possible service call. Try the suggestions below to see if you can solve the problem before calling for service.

Problem	Possible Causes
The refrigerator does not operate.	<ul style="list-style-type: none">•The power cord is unplugged.•The circuit breaker is tripped/fuse blown.
The compressor turns on and off.	<ul style="list-style-type: none">•The room temperature is warmer than normal.•A large amount of food has been added to the refrigerator.•The door is left open or is frequently opened.•The temperature control is not set correctly•The door is not closed completely.•The door gasket does not seal properly.•The refrigerator does not have the correct clearances.•The refrigerator has recently been disconnected for a period of time.
The temperature inside the refrigerator is too warm.	<ul style="list-style-type: none">•The temperature control is not set correctly.•The door is left open or is not set correctly.•The door gasket does not seal properly.•A large amount of warm or hot food was stored recently. Wait for the refrigerator to reach its selected temperature.•The refrigerator has recently been disconnected for a for a while.
Vibrating or rattling. (slight vibration is normal)	<ul style="list-style-type: none">•Levelling legs need adjusting.•Refrigerator is placed on an uneven or weak surface.•The refrigerator is touching the wall. Re-level the refrigerator and move it away from the wall.
The temperature of the external of the refrigerator's surface is warm.	<ul style="list-style-type: none">•The exterior refrigerator walls can be as much as 30°F warmer than room temperature.•This is normal while the compressor works to transfer heat from inside the refrigerator cabinet.
Moisture collects inside the refrigerator.	<ul style="list-style-type: none">•The door is slightly open or is frequently opened.•The door is not sealed properly.
Moisture forms on the outside of refrigerator.	<ul style="list-style-type: none">•Is normal in hot and humid weather. Air carries moisture into the refrigerator when doors are opened.
Bubbling or gurgling sounds. (like boiling water)	<ul style="list-style-type: none">•This is the normal sound of refrigerant (used to cool the refrigerator) circulating throughout the system.
Popping or crackling sounds when the compressor comes on.	<ul style="list-style-type: none">•This is normal. Metal parts undergo expansion and contraction. The sound will level off or disappear as the refrigerator runs.
The door will not close properly.	<ul style="list-style-type: none">•The refrigerator is not on a level surface.•The gasket is dirty.•A storage basket is out of position.

For any questions or concerns, please contact us at customerservice@stirlingmarathon.com or visit us at www.stirlingmarathon.com



2 Years Limited Warranty

When operated and maintained according to the instructions in the Use & Care Guide, MARATHON a registered trademark of Stirling Marathon Limited agrees to repair this product for 2 years from the date of original purchase and/or agrees to pay for parts and service/labour required to correct defects in materials or workmanship. Any Service must be approved and provided by an Authorized Stirling Marathon Service provider. YOUR EXCLUSIVE REMEDY UNDER THIS LIMITED WARRANTY SHALL BE PRODUCT REPAIR OR REPLACEMENT AT THE SOLE DISCRETION OF STIRLING MARATHON LIMITED AS PROVIDED HEREIN. This limited warranty is valid only in Canada and the Continental United States with proof of original purchase and confirmed warranty registration.

TERMS OF WARRANTY BY PRODUCT	Capacity/Type	Warranty Type
Refrigeration & Freezer	Less than 6 cu.ft	Carry-In
Refrigeration & Freezer	Greater than 6 cu.ft.	In-Home
Electric & Gas Ranges	All Sizes	In-Home

How to Obtain Service

Carry-In: The original purchaser must deliver or ship the defective product to an authorized Stirling Marathon Service present a copy of the original bill of sale or Warranty Registration Confirmation.

In-Home: Contact Authorized Service Center and provide a copy of the Original bill of sale or Warranty Registration Card. If you are in a remote area or the closest Authorized Service Center is further than 100 km (60 miles), you will be required to deliver the appliance to the closest Service Center at your expense.

Stirling Marathon is not responsible or liable for any spoilage or damage to food or other contents of this appliance, whether due to any defect of the appliance, or its use, whether proper or improper.

Items Excluded from Warranty

- Damages due to shipping or improper installation.
- Damages due to misuse or abuse.
- Content losses due to failure of the unit.
- Commercial or Rental Use Limited to 90 days Parts & Labour.
- Plastic parts such as door bins, panels, door shelves, racks, light bulbs, etc.
- Punctures to the evaporator system due to improper defrosting of the unit.
- Service or Repair by a unauthorized service technicians.
- Service calls that do not involve defects in material and workmanship such as instruction on the proper use of the product, door reversal or improper installation.
- Replacement or resetting of house fuses or circuit breakers.
- Delivery costs incurred as the result of a unit that fails.
- Expenses for travel and transportation for product service if your appliance is located in a remote area where service by an unauthorized service technician is not available.
- The removal and reinstallation of your appliance if it is not installed correctly or is in a inaccessible location, as per the published installation instructions.
- Liability under this warranty is limited to repair, replacement or refund. If a replacement unit is not available or the unit cannot be repaired, liability is limited to the actual.
- Purchase price paid by the consumer.
- This warranty applies only to the original purchaser and does not extend to any subsequent owner(s) and is non-transferable.
- No warranty or insurance herein contained or set out shall apply when damage or repair is caused by any of the following: accident, alteration, abuse or misuse of the appliance such as inadequate air circulation in the room or abnormal operating conditions (extremely high or low room temperature).
- Use for commercial or industrial purposes (i.e. If the appliance is not installed in a domestic residence). Fire, water damage, theft, war, riot, hostility, acts of God such as hurricanes, floods etc.
- Service calls resulting in customer education.
- Improper installation (ie. Building-in of a free-standing appliance or using an appliance outdoors that is not approved for outdoor application).

For any questions or concerns, please contact us at customerservice@stirlingmarathon.com or visit us at www.stirlingmarathon.com

V.01/2024