



## PREMIUM WINE COOLER



### Owners use and care guide

**MWC28-DSS | MBWC56-SS | MBWC56-BLS | MWC56-DSS | MBWC56-DBLS**

#### **Congratulations on the purchase of your new Premium Wine cooler!**

To activate your Warranty, please register your appliance at [www.stirlingmarathon.com](http://www.stirlingmarathon.com) or by completing and mailing the enclosed Warranty Registration Card. We are confident you will have years of hassle free enjoyment and ask that you please retain the Use & Care Guide for future reference and your safety.

Before installing please, read your Use & Care guide carefully and pay special attention to the Safety & Warning information outlined in the following pages

**For immediate assistance: 1-844-309-9777**  
**[www.stirlingmarathon.com](http://www.stirlingmarathon.com)**

# Table of Contents

---

Important Safety information .....	3
Installation location.....	4
Installation requirements (MWC28-DSS).....	5
Installation requirements (MBWC56-SS   MBWC56-BLS   MWC56-DSS   MWC56-DBLS)..	6
Reversing door instruction .....	7-8
Switching the appliances “On”.....	9
Control description .....	10-11
Setting The Temperature.....	12
Charcoal Filtration System .....	12
Care & Maintenance.....	13
Serving Temperature Chart.....	14
Adjusting the Removable Shelves.....	15
Troubleshooting.....	16
Warranty.....	17

**WARNING**

- Do not move your Cabinet while loaded with wine. You might distort the body. The wine cellar should be installed in a suitable place in order to avoid touching the compressor with hand.
- This appliance can be used by children aged from 8 years and above and persons with reduced physical, sensory or mental capabilities or lack of experience and knowledge if they have been given supervision or instruction concerning use of the appliance in a safe way and understand the hazards involved. Children shall not play with the appliance. Cleaning and user maintenance shall not be performed by children without supervision.
- If the supply cord is damaged, it must be replaced by manufacturer or its Service agent or a similarly qualified person in order to avoid a hazard.
- Opening the door for long periods can cause a significant increase of the temperature in the compartments of the appliance.
- Clean regularly surfaces that can come in contact with food and accessible drainage systems.
- If the refrigerating appliance is left empty for long periods, switch off, defrost, clean, dry, and leave the door open to prevent mould developing and odour within the appliance.

**\*\*\* DO NOT USE AN EXTENSION CORD\*\*\***

**DANGER**

To reduce the risk of fire, electrical shock, or injury when using your appliance, follow these basic precautions :

- Read all instructions before using the Wine cooler.
- DANGER or WARNING: Risk of child entrapment.
- Child entrapment and suffocation are not problems of the past. Junked or abandoned appliances are still dangerous even if they will "just sit in the garage a few days".
- Before you throw away your old Wine cooler/Beverage Cooler: Take off the door. Leave the shelves in place so that children may not easily climb inside.
- Children should be supervised to ensure that they do not play with the appliance.
- Never clean appliance parts with flammable fluids. The fumes can create a fire hazard or explosion.
- Do not store explosive substances such as aerosol cans with a flammable propellant in this appliance. The fumes can create a fire hazard or explosion. Do not store explosive substances such as aerosol cans with a flammable propellant in this appliance.
- WARNING: Keep ventilation openings, in the appliance enclosure or in the built-in structure, clear of obstruction;
- To avoid a hazard due to instability of the appliance, it must be fixed in accordance with the instructions.
- WARNING: Do not damage the refrigerant circuit;
- WARNING: When positioning the appliance, ensure the supply cord is not trapped or damaged.
- WARNING: Do not locate multiple portable socket-outlets or portable power supplies at the rear of the appliance.
- Flammable and explosive items should never be put in or stored near the wine cooler.

-----SAVE THESE INSTRUCTIONS-----

## Installing your Marathon Wine Cooler

Before using your new Wine Cooler, we recommend leaving Cooler door open and unplugged for 24 hours prior to installation or use. This will allow time to clear any residual odors from the interior liner and hardwood shelves.

Your Premium Marathon Wine Cooler is engineered for built-in or free standing installation. The front bottom vent must not be covered.

Your Marathon Wine Cooler is also equipped with 4 adjustable feet to facilitate easy leveling. We recommend that you tighten the back feet first and then adjust the front feet to level the wine cooler.

## Installation location

Choosing the right location for your Wine Cooler is important. We highly recommend the following location criteria:

- The appliance must be positioned such that the plug and power outlet are accessible. Release the power cord and move the appliance to its final location. The appliance should be installed in a suitable place where the compressor will not be subject to physical contact, unencumbered and well ventilated Dry area, not too damp or humid - ideally at maximum 65% +/- 5% relative humidity for peak performance and reduced sweating on the interior door when opening. If the temperature is above or below this range, it may affect the performance of the Wine and/or beverage cooler. Placing in cold, hot or humid temperature conditions may cause temperature fluctuations and increased running operation costs.
- Flat, level floor
- Approved electrical outlet (preferably with surge protector) within 3 feet of the Wine Cooler.
- Minimum 1 meter from any microwave oven. Certain microwave ovens do not have a wave interference shield. When placed too close to the wine or beverage cooler , the performance may be affected.
- **Marathon Wine Coolers are NOT CERTIFIED for outdoor use. Outdoor use will void your warranty and possibly cause a safety hazard and result in fire or personal injury.**



**CAUTION!** Your Marathon wine cooler is equipped with a three prong power cord which has a ground wire. The plug should never be altered or used with an extension cord or power bar. Improper use of the grounding plug can result in the risk of electric shock. Consult a qualified electrician or service person if the grounding instructions are not completely understood. If the supply cord is damaged, it must be replaced by a qualified person in order to avoid electrical hazard.

## MWC28-DSS Cutout & Dimensions



In "Hot and Humid locations", an air vent with a minimum ventilation size of 200mm x 40mm **MUST** be cut out on each side OR 2 circular shapes with a diameter of 65mm at the top of either side of the partitioning, allowing cool air to flow into the rear of the cabinet. This air vent must not be opened on the same side as other appliances, such as ovens, or an area that is sealed and without access to fresh cool air. **Failing to comply with the above specifications could result in WARRANTY BECOMING VOID.**

Please ensure you have a minimum of 3/16" clearance on each side of the unit. This space will allow fresh air to flow freely and remove and insert easily the wine cooler as needed. **Warning! DO NOT SEAL BY SILICON OR ANY OTHER MANNER THE SIDE OF THE UNIT OTHERWISE THE GUARANTEE WILL BE VOID**

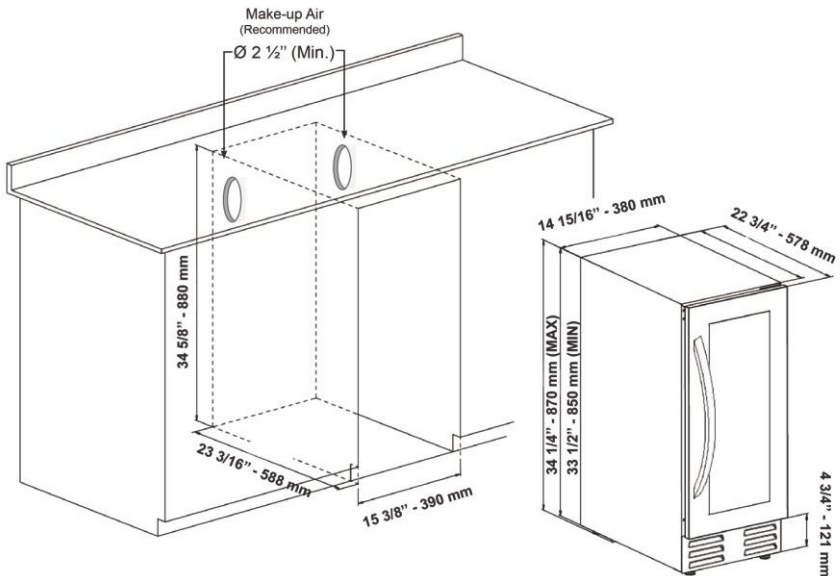

1. Please follow the installation diagram when installing built-in wine cellars. Use no less than the minimum installation dimension, or it will affect the venting of cellar.
2. Built in wine cellars have a power switch located on the control panel so power point location is not critical.
3. The wine cellar requires a standard 120 volt/15 amp dedicated power supply.
4. The power cord is approx. 6 ft./2M in length and is fixed on the right side at the back when looking from front of cabinet.

## MBWC56-SS | MBWC56-BLS | MWC56-DSS | MWC56-DBLS Cutout & Dimensions



In "Hot and Humid locations", an air vent with a minimum ventilation size of 200mm x 40mm **MUST** be cut out on each side OR 2 circular shapes with a diameter of 65mm at the top of either side of the partitioning, allowing cool air to flow into the rear of the cabinet. This air vent must not be opened on the same side as other appliances, such as ovens, or an area that is sealed and without access to fresh cool air. **Failing to comply with the above specifications could result in WARRANTY BECOMING VOID.**

Please ensure you have a minimum of 3/16" clearance on each side of the unit. This space will allow fresh air to flow freely and remove and insert easily the wine cooler as needed. **Warning! DO NOT SEALED BY SILICON OR ANY OTHER MANNER THE SIDE OF THE UNIT OTHERWISE THE GUARANTEE WILL BE VOID.**

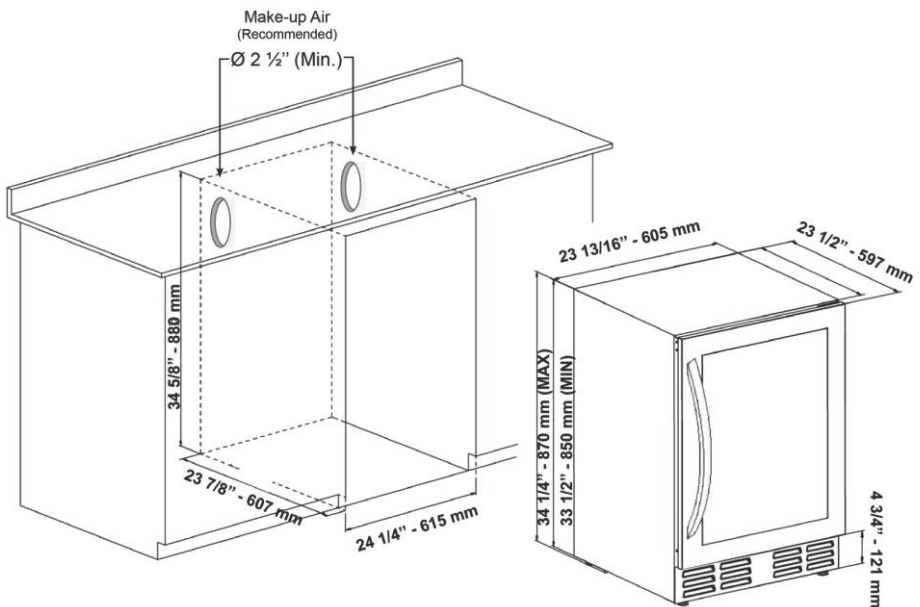

1. Please follow the installation diagram when installing built-in wine cellars. Use no less than the minimum installation dimension, or it will affect the venting of cellar .
2. Built-in wine cellars have a power switch located on the control panel so power point location is not critical.
3. The wine cellar requires a standard 120 volt/15 amp dedicated power supply.
4. The power cord is approx. 6 ft./2M in length and is fixed on the right side at the back when looking from front of cabinet.

## Step by step instructions

**Step 1** Place the wine cooler in an open area allowing the door (D) to be opened to the maximum angle and free from obstruction.

**Step 2** Use a thin knife (B) or screwdriver to remove the 3 plastic hole cover caps (A). Keep these caps for step 7.

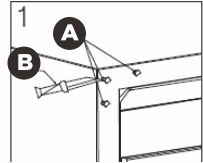

**Step 3** Use a flat-blade screwdriver to open the upper hinge buckle (F) to see the hinge shaft (E) and then use a flat-blade screwdriver to pry the hinge shaft (E) and take it out. Then unscrew the lower hinge in the same way.

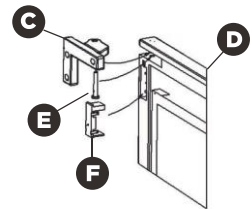

**C** Door Hinge    **D** Glass Door    **E** Hinge Shaft    **F** Hinge Buckle

**Step 4** When the upper and lower parts are removed, pull the door parallel to the outside. The door can be taken out.

**Step 5** The upper hinge and lower hinge are also exchanged at the same time. The right upper hinge is changed into the left lower hinge. The right lower hinge is changed into the left upper hinge. Becomes the lower door hinge, and becomes the upper door hinge when the right lower door hinge is changed to the left side;

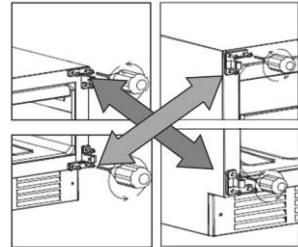

**Step 6** The magnet of the door must be removed and reinstalled to the other side.

1. Unscrew the alarm magnet (3) from door (1)
2. Change the magnet (3) position to magnet fix hole (2)

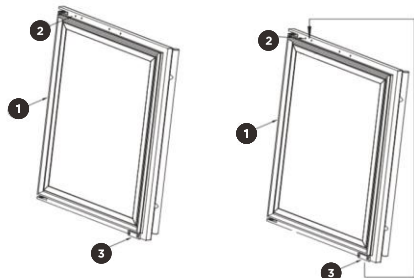

**Step 7** Install the hole cover caps removed in step 2 to cover the 3 holes on the side where the door was removed.

**Step 8** Insert the lower hinge into the corner fittings, align the mounting holes, and insert the hinge shaft **(E)** into the hinge hole in position. Then cover back the Hinge buckle **(F)**. The installation of the lower part of the door is completed;

**Step 9** To install the upper part of the door use the same method as the lower part of the installation door.

**Note:** When installing the upper door hinge, please move the door hinge to the side of the outer casing and then tighten the screw. After the lower door is installed, move the screw to the side of the outer casing and tighten the screw to prevent the door falling



## Unpacking and cleaning the wine cooler

Use a soft cloth to clean the interior surface with lukewarm water.

## Switching The Appliance On

Before connecting the refrigerator to an electrical power supply, let it stand upright for approximately 2 hours to let the refrigerant settle in the compressor. This will reduce the possibility of malfunctions in the cooling system due to transportation. Please wipe and clean the interior of the refrigerator thoroughly with a damp, non-abrasive cloth. Once positioned, plug the wine cooler into the power outlet and turn "ON"

### MWC28-DSS | MWC56-DSS | MWC56-DBLS:

by pressing the "Power Button"  and  for 3 seconds,

### MBWC56-SS | MBWC56-BLS:

by pressing  for 3 seconds.

When you use your Marathon wine cooler for the first time (or restart the appliance after having it shut off for a long time) there will be a few degrees variance between the temperature you have selected and the one indicated on the LED readout. This is normal and will adjust to the desired temperature once the compressor and cooling system has been running for several hours.

## Frost Free Fan Cooled Operation

Your Wine cooler is engineered with a high efficiency compressor cooling system that uses a fan to cool and regulate your desired temperature setting. This means you never have to worry about defrosting your wine & beverage cooler and it will provide years of hassle free enjoyment. Like all Frost Free and compressor appliances, you will hear the fan operating and the compressor cycling on and off while it defrosts itself. The following sounds will most likely occur during normal operation:

- Gurgling sound - caused by the refrigerant flowing through the appliances coils
- Crackling/popping sounds - resulting from the contraction and expansion of the refrigerant gas to produce cold.
- Fan operating sound - to circulate the air within the wine cellar.

### LED Temperature Control

**IMPORTANT:** The LED temperature displays the actual internal air temperature of your Marathon Wine cooler. The temperature settings are preset at the factory and in the event of a power interruption, all previous temperature settings are automatically erased and it will revert back to the factory preset temperature settings.





Once you program your desired temperature setting, it is strongly recommended not to adjust frequently. The thermostat is accurate and will maintain the temperature inside the wine cellar +/- 2.5° C. Please note that the depending on the thickness of the wine bottle, and loading, the actual temperature of the wine may differ from the wine and beverage cooler setting by +/- 1°C.

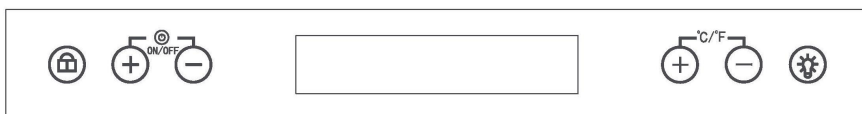

#### FOR MWC28-DSS / MWC56-DSS / MWC56-DBLS







Temperature control range: Upperzone 5-12°C (41-54°F )lowerzone 12-20°C (54-68°F )

Press  3 seconds to unlock/lockall the buttons.If there is no any operationwithin 15 seconds after unlock, the buttons will be locked automatically.

Press left  or  to adjust the temperature of upper zone.

Press right  or  to adjust the temperature of lower zone.

Press left  and  at the same time for 3 seconds to power on/off.

Press right  and  at the same time for 3 seconds to switch between °C and°F.

Press  to turn on or off the lights.

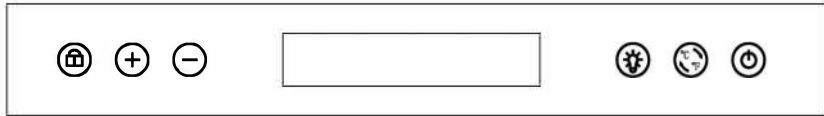
**FOR MBWC56-SS, MBWC56-BLS****Temperature control range: 2-12°C (36-54°F)**

Press  3 seconds to unlock/lock all the buttons. If there is no any operation within 15 seconds after unlock, the buttons will be locked automatically.

Press  to increase the interior setting temperature.

Press  to decrease the interior setting temperature.

Press  to turn on or off the interior lights.

Press  for 3 seconds to change the temperature display between °C and °F.

Press  for 3 seconds to power on or off the unit.

## Setting The Temperature Controls

- When press the temperature setting button  $\oplus$  or  $\ominus$  the system will enter the set up mode of the upper or lower compartment automatically. The LED display will flash and show the setting temperature. After 5 seconds the flash will stop and it will show the actual measured interior temperature.
- Press the button once, the temperature will decrease or increase 1°C/°F. After stopping pressing the button for 5 seconds, LED figure will stop flash, then revert back to display the setting temperature of the upper or lower compartment.
- After the unit is unplugged, the system will return to default setting temperature, which set by factory.

*The default setting temperature as below:*

Single zone models: Default setting temperature 6°C

Dual zones models: Default setting temperature 6°C for upper zone and 12 °C for lower zone.



**IMPORTANT:** If the unit is unplugged, power lost, or turned off, you must wait 3 to 5 minutes before restart the unit. If you need attempt to restart before this time delay, the Wine Cooler/Beverage Cooler will not start. If first time use or longer absence of using, the temperature will difference between setting and LED display temperature. After running a period, the temperature will be reverting back.

## Charcoal Filtration System

Your wine is a living object that breathes through the cork of its bottle. In order to preserve the quality and taste of your fine wines, they must be stored at the ideal temperature and ambient conditions. Your cellar is equipped with an active charcoal filtration system to ensure air purity, cooling efficiency, and to maintain an odor free cabinet for the storage of your fine wines. The filter assembly is located at the rear panel inside your cellar.

Keep in mind, that this filter must be changed every 12 months.

### To replace your filter:

1. Remove the bottles of wine stored on the two (2) shelves in front of the filter.
2. Remove the shelves and set aside to be replaced once you have changed the filter
3. Hold the filter and turn it at 45 degrees in the counter-clockwise direction and then pull it out.
4. Remove the existing filter and replace with a new one.
5. Put the new filter into the hole and then turn the filter at 45 degrees in clockwise direction.

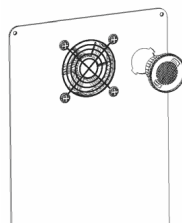

Turn Left to remove filter.

## **CARE & MAINTENANCE**

### **Clean your Wine Cooler/Beverage Cooler**

1. Turn off the power, unplug the appliance, and remove all items including shelves and rack.
2. Wash the inside surfaces with a warm water and mild solution.
3. Wash the shelves with a mild detergent solution.
4. Wring excess water out of the sponge or cloth when cleaning area of the controls, or any electrical parts.
5. Wash the outside cabinet with warm water and mild liquid detergent. Rinse well and wipe dry with a clean soft cloth.

### **Power failure**

In the event of a power interruption, all previous temperature settings are automatically saved and will revert to a preset temperature setting.

Most power failures are corrected within a few hours and should not affect the temperature of your appliance if you minimize the number of times the door is opened. If the power is going to be off for a long period of time, you need to take the proper steps to protect your contents.

### **Vacation Time**

**Short vacations:** Leave the appliance operating during vacations of less than three weeks.

**Long vacations:** If the appliance will not be used for several months, remove all items and turn off the appliance. Clean and dry the interior thoroughly. To prevent odor and mold growth, leave the door open slightly, blocking it open if necessary.

### **Moving your Wine Cooler/Beverage Cooler:**

1. Remove all stored items.
2. Securely tape down all loose items (shelves) inside your appliance.
3. Turn the adjustable legs up to the base to avoid damage.
4. Tape the door shut.
5. Be sure the appliance stays secure in the upright position during transportation. Also, protect the outside of the appliance with a blanket or similar item.

### **Energy saving tips**

- The appliance should be located in the coolest area of the room, away from heat producing appliances and out of direct sunlight.
- Ensure that the unit is adequately ventilated.
- Do not keep the door open any longer than necessary.

### Recommended Wine Serving Temperature Chart

The chart below is a guide to recommended temperatures for wines. This is a guide only as personal preferences vary...enjoy!

Champagne NV	Sparkling	Spumante			6°C	43°F
Dry White Semillon	Sauvignon Blanc				8°C	43°F
Champagne Vintage					10°C	50°F
Dry White Chardonnay					10°C	50°F
Dry White Gewürztraminer	Riesling	Pinot Grigio			10°C	50°F
Sweet White Sauternes	Barsac	Montbazillac	Ice Wine	Late Harvest	10°C	50°F
Beaujolais					13°C	55°F
Sweet White Vintage: Sauternes					14°C	57°F
White Vintage Chardonnay					14°C	57°F
Red Pinot Noir					16°C	61°F
Red Grenache	Syrah				16°C	61°F
Red Vintage Pinot Noir					18°C	64°F
Cabernet & Merlot:	French	Australian	New Zealand		20°C	68°F
Chilean, Italian	Spanish	Californian	Argentinean			
Vintage Bordeaux					Room temperature not exceeding 20°C 68°F	

#### Important information about storing your wine

Your Marathon wine and/or beverage cooler has been "engineered to perform" and provide the perfect conditions for storing and/or serving your wine. Fine wines require long and gentle development and need specific conditions in which to reach their full potential. Ideally, for long term storage, we suggest keeping your wine cooler at a constant temperature between 12°C and 14°C.

Please note that not all wines will improve over the years, and some must be consumed within the first few years of bottling, while other fine wines are capable of ageing over 50 years. For questions regarding the maturity of your wines, we suggest you consult your local wine retailer for information on the wine of your choice

## Adjusting the Removable Shelves

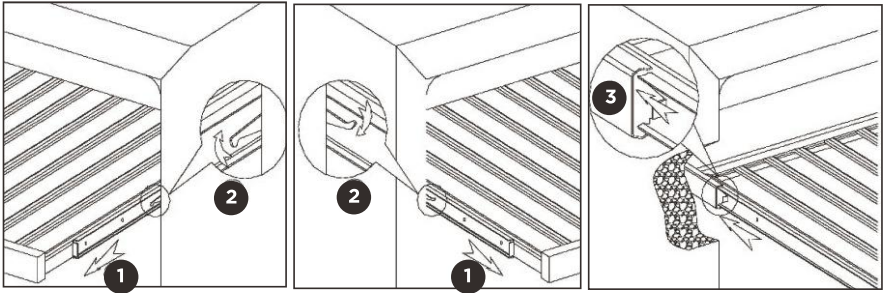

To remove the pull out the shelf to support bracket ①, press the two clips of the roller bracket in and up, and pull out the shelf following the arrows ②. To reinstall push in the shelf alignment with two sides of sliding roller following the arrows ③.

**IMPORTANT!** There are some sounds during normal use (compressor, refrigerant/circulation)

You can solve many common problems easily, saving you the cost of a possible service call. Try the suggestions below to see if you can solve the problem before calling the service technician.

Problem	Possible causes
Appliance is not running	Appliance is not plugged in. Appliance is not turned on. Check the voltage of the installation. Check if the circuit breaker or the fuse has blown.
Door is fogging or sweating	Fogging on interior glass is normal since when opening the interior is cooler than the room temperature. If sweating on exterior glass, the ambient temperature and/or humidity is too high. Please relocate to a better temperature controlled environment (15°C-25°C and maximum 70% humidity)
Appliance is not cold enough	Check the temperature control setting. Check if ambient temperature is beyond appliance operating temperature. The door is opened too frequently. The door is not closed properly. The door is not sealing properly. Insufficient free space around the appliance.
The compressor starts and stops frequently	The external temperature is high. A large quantity of bottles has been put into the cellar. The appliance is opened frequently. The door is not properly closed. The cellar has not been correctly set.
LED lights do not operate	The appliance is not plugged in. The fuse has blown. LED lights are broken The light switch is off.
Vibration	Check and ensure that the appliance is level.
The appliance makes a lot of noise	The rattling noise may come the flow of the refrigerant, which is normal. At the end of a cooling cycle, you can hear the noise of water circulating. Expansion and contraction of the internal walls may cause a cracking sound. The appliance is not level. Check if the fan is in good condition.
The door does not close properly	The appliances is not level. The door seal is dirty or damaged. The shelves are not positioned correctly. A part of the contents is preventing the door from closing.

*For immediate assistance: 1-844-309-9777 or [customerservice@stirlingmarathon.com](mailto:customerservice@stirlingmarathon.com)*



## 2 Year Limited Warranty

When operated and maintained according to the instructions in the Use & Care Guide, Marathon, a registered trademark of Stirling Marathon Limited, agrees to repair or replace this product for 2 years from the date of original purchase and/or agrees to pay for parts and service/labor required to correct defects in materials or workmanship. Any and all Service must be approved and provided by an Authorized Stirling Marathon Service provider. YOUR EXCLUSIVE REMEDY UNDER THIS LIMITED WARRANTY SHALL BE PRODUCT REPAIR OR REPLACEMENT AT THE SOLE DISCRETION OF STIRLING MARATHON LIMITED AS PROVIDED HEREIN. This limited warranty is valid only in Canada and the Continental United States with proof of original purchase and confirmed warranty registration.

### TERMS OF WARRANTY BY PRODUCT

	Capacity/Type	Warranty Type
Refrigerators, Freezers & Wine Coolers	Less than 6 cu.ft.	Carry-In
Refrigerators & Freezers	Greater than 6 cu.ft.	In-Home
Electric & Gas Ranges	All Sizes	In-Home
Premium Wine Coolers	Premium Built-in	In-Home

## How to Obtain Service

**Carry-In:** The original purchaser must deliver or ship the defective product to an authorized Stirling Marathon Service present a copy of the original bill of sale or Warranty Registration Confirmation

**In-Home:** Contact Authorized Service Center and provide a copy of the Original bill of sale or Warranty Registration Card. If you are in a remote area or the closest Authorized Service Center is further than 100 km (60 miles), you will be required to deliver the appliance to the closest Service Center at your expense.

Stirling Marathon is not be responsible or liable for any spoilage or damage to food or other contents of this appliance, whether due to any defect of the appliance, or its use, whether proper or improper.

## Items Excluded from Warranty

- Damages due to shipping damage or improper installation.
- Damages due to misuse or abuse.
- Content losses due to failure of the unit
- Commercial or Rental Use Limited to 90 days Parts & Labor
- Plastic parts such as door bins, panels, door shelves, racks, light bulbs, etc.
- Punctures to the evaporator system due to improper defrosting of the unit.
- Service or Repairs by unauthorized service technicians
- Service calls that do not involve defects in material and workmanship such as instruction on proper use of the product, door reversal or improper installation.
- Replacement or resetting of house fuses or circuit breakers.
- Delivery costs incurred as the result of a unit that fails
- Expenses for travel and transportation for product service if your appliance is located in a remote area where service by an authorized service technician is not available.
- The removal and reinstallation of your appliance if it is installed in an inaccessible location or is not installed in accordance with published installation instructions.
- Liability under this warranty is limited to repair, replacement or refund. If a replacement unit is not available or the unit cannot be repaired, liability is limited to the actual purchase price paid by the consumer.
- This warranty applies only to the original purchaser and does not extend to any subsequent owner(s) and is non-transferable.
- No warranty or insurance herein contained or set out shall apply when damage or repair is caused by any of the following
  - Accident, alteration, abuse or misuse of the appliance such as inadequate air circulation in the room or abnormal operating conditions (extremely high or low room temperature)
  - Use for commercial or industrial purposes (ie. If the appliance is not installed in a domestic residence)
  - Fire, water damage, theft, war, riot, hostility, acts of God such as hurricanes, floods etc
  - Service calls resulting in customer education.
- Improper Installation (ie. Building-in of a free standing appliance or using an appliance outdoors that is not approved for outdoor application)

**For immediate assistance: 1-844-309-9777**

[www.stirlingmarathon.com](http://www.stirlingmarathon.com)