

LIEBHERR

Use and Care Manual

For Wine Cooler

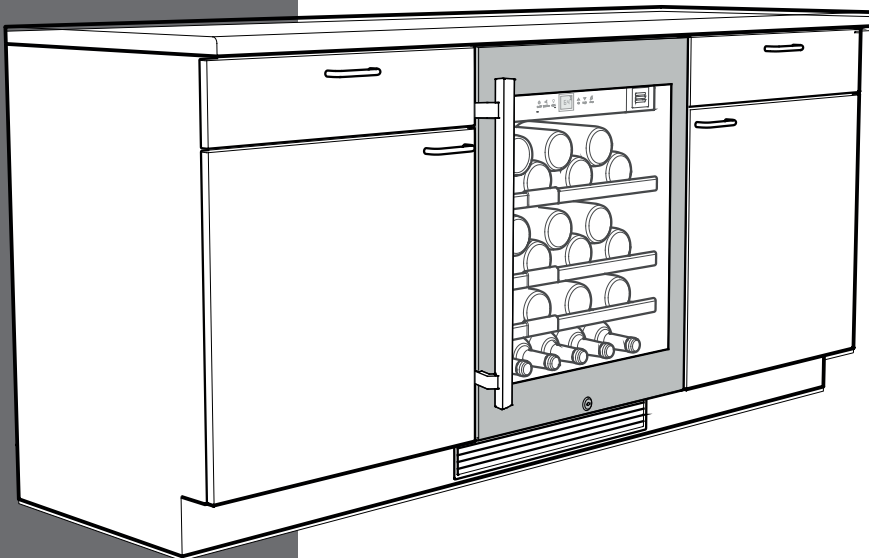

WU 4500
7080 166-01

TABLE OF CONTENTS

Contents	Page
Please Read and Follow these Instructions.....	2
California Proposition 65	2
Disposal of Old Appliance	3
Disposal of this Appliance	3
R600a Refrigerant	3
Important Safety Information	4
Electrical Safety	4
Safety Regulations.....	5
Disposal of Carton	5
Setting Up	5
The right environment for your wines.....	6
Description of the Appliance	6
Operating and Control Elements.....	7
Switching the Appliance On and Off.....	7
Setting the Temperature	7
Storing Wine	7
Door Open Alarm.....	8
Temperature Alarm	8
Ventilation Button.....	8
Setup Mode.....	8
Interior light	11
Air Exchange with Activated Charcoal Filter.....	11
Additional Features.....	12
Storage diagram	13
Safety Lock	13
Cleaning	14
Customer Service	15
Appliance information	15
Turning Off the Appliance.....	15

IMPORTANT

All types and models are subject to continuous improvement. The manufacturer reserves the right to make modifications in the shape, equipment and technology.

Please Read and Follow these Instructions

These instructions contain Danger, Warning and Caution notes.

This information is important for safe and efficient installation and operation.

Always read and comply with all Danger, Warning and Caution notes!



DANGER!

Danger indicates a hazard which will cause serious injury or death if precautions are not followed.



WARNING!

Warning indicates a potentially hazardous situation which, if not avoided, could result in death or serious injury.



CAUTION!

Caution indicates a potentially hazardous situation which, if not avoided, may result in minor or moderate injury.

IMPORTANT

This indicates information that is especially relevant to a problem-free installation and operation.

California Proposition 65

- This product contains chemicals known to the state of California to cause cancer or reproductive harm.
- This product can expose you to chemicals including Diisononyl Phthalate (DINP) which is known to the State of California to cause cancer. For more information go to www.P65Warnings.ca.gov.
- This product can expose you to chemicals including Di-isodecyl Phthalate (DIDP) which is known to the State of California to cause birth defects or other reproductive harm. For more information go to www.P65Warnings.ca.gov.

Disposal of Old Appliance



DANGER!

Risk of child entrapment.

Child entrapment and suffocation are not problems of the past.

Junked or abandoned refrigerators are still dangerous – even if they will sit for “just a few days.”

If you are getting rid of your old refrigerator, please follow these instructions to help prevent accidents.

Before you discard old appliances:

- Take off the doors.
- Leave the shelves in place so that children may not easily climb inside.
- Cut off the power cable from the discarded appliance. Discard separately from the appliance.
- Be sure to follow your local requirements for disposal of appliances.

Contact the trash collection agency in your area for additional information.

Disposal of this Appliance

This appliance contains flammable gases within the refrigeration circuit and insulation foam.

Contact the municipality or disposal company in your area for information on approved recycling or disposal.

R600a Refrigerant



WARNING!

The refrigerant R600a contained within the appliance is environmentally friendly, but flammable. Leaking refrigerant can ignite.

To prevent possible ignition, follow the warnings below:

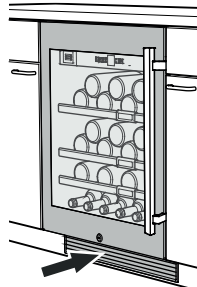
- Keep ventilation openings, in the appliance enclosure or in the built-in structure, clear of obstruction. 
- Do not use mechanical devices or other means to accelerate the defrosting process, other than those recommended by the manufacturer.
- Do not damage the refrigerant circuit.
- Any repairs and work on the appliance should only be performed by the customer service department.
- Do not use electrical appliances inside the wine cooler compartment, unless they are of the type recommended by the manufacturer.

SAFETY

Important Safety Information

- To prevent injury to you or damage to the unit, the appliance should be unpacked and set up by two people.
- If the appliance is damaged on delivery, contact the supplier immediately before connecting it to the power source.
- To guarantee safe operation, ensure that the appliance is set up and connected as described in this manual.
- Disconnect the appliance from the power source if a fault occurs. Pull out the plug, turn off or disable the power source.
- When disconnecting the appliance, always pull it out by the plug; never pull on the cable.
- Any repairs and work on the appliance should only be performed by the customer service department. Unauthorized work may be dangerous to the user. The power source cable should only be changed or replaced by the customer service department.
- Do not store explosives or sprays using combustible propellants such as butane, propane, pentane, etc. in the appliance. Electrical components might cause leaking gas to ignite. You can identify such sprays by the printed contents or a flame symbol.
- To prevent possible injury due to an electrical shock, be sure to disconnect the power cord or turn off the circuit breaker before cleaning the appliance.
- To avoid injury or damage to the appliance, do not use steam cleaning equipment to clean the appliance.
- Do not operate the appliance in the presence of explosive fumes.
- In the event of a power outage, open the door as infrequently as possible.
- To protect the appliance from possible damage, allow it to stand 1/2 to 1 hour in place before turning on the electricity. This allows the refrigerant and system lubrication to reach equilibrium.

Electrical Safety

Connect this appliance to a 15 amp or 20 amp, 110-120 VAC, circuit which is grounded and protected by a circuit breaker or fuse.

We recommend using a dedicated circuit for this appliance to prevent circuit overload and the chance of interruption to the appliance.

This appliance is equipped with a three-prong (grounding) polarized plug for your protection against possible shock hazards.

Where a two-prong wall receptacle is encountered, contact a qualified electrician and have it replaced with a properly grounded three-prong receptacle in accordance with all local codes and ordinances.



WARNING!

Electrocution hazard.

Electrical grounding required.

- **Do not remove the round grounding prong from the plug.** →
- **Do not use extension cords or ungrounded (two-prong) adapters.**
- **Do not use a power cord that is frayed or damaged.**

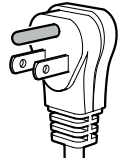

- **Do not use a power strip.** →

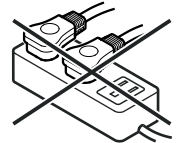

Failure to follow these instructions may result in fire, electrical shock or death.

Safety Regulations

The appliance is designed to cool and store wine and beverages. It is designed as a household appliance.

IMPORTANT

The appliance is not intended for outdoor use.

The appliance is manufactured to operate within specific ambient temperature limits according to its climate rating.

The climate rating indicates the ambient temperature at which the appliance may be operated in order to deliver optimal refrigeration performance.

Climate Rating	Ambient Temperature
SN-ST	50°F to 100°F (10°C to 38°C)

IMPORTANT

Do not operate the appliance outside the specified ambient temperature range.

- The refrigerant circuit has been tested for leaks.
- The appliance complies with current safety regulations

CAN/CSA C22.2 No.60335-1-11
UL 60335-1 Fifth Edition
CAN/CSA C22.2 No. 60335-2-24-06
UL 60335-2-24 First Edition

We recommend cleaning the appliance before turning it on for the first time. See **Cleaning**.

Turn on the appliance several hours before filling it.

WARNING!

Do not allow children to play with the appliance. Children must not climb, sit or stand on the shelves or door.

Failure to follow these instructions may result in death or serious injury.

Disposal of Carton

The packaging is designed to protect the appliance and individual components during transport and is made of recyclable materials.

WARNING!

Keep packaging materials away from children. Polythene sheets and bags can cause suffocation!

If possible, please recycle packaging material at a recycling facility.

Setting Up

CAUTION!

To avoid risk of personal injury or property damage, have two people unpack and move this appliance into place.

IMPORTANT

Protect the finished floor surface before you uncrate the unit.

Avoid placing the appliance in direct sunlight or near the stove, range top, radiators and similar heat sources.

As soon as you uncrate the unit:

- Examine the unit and packaging for shipping damage. Contact the carrier immediately if you suspect there is any damage.
- Note the type (model number), service number, appliance / serial number, date of purchase and where purchased in the space provided in the back of this manual.

FEATURES

The right environment for your wines

A grapevine is an extremely sensitive plant.

From the time it is planted until its maturing period and the time the grapes are harvested and the wine is made, it is dependent on three factors: light, air humidity and ambient temperature.

This sensitivity continues even after the wine is bottled.

To allow the flavor of the wine to fully develop or to preserve the excellent aroma, the wine has to be stored at optimal conditions.

Your wine cooler offers the best conditions for this.

Description of the Appliance

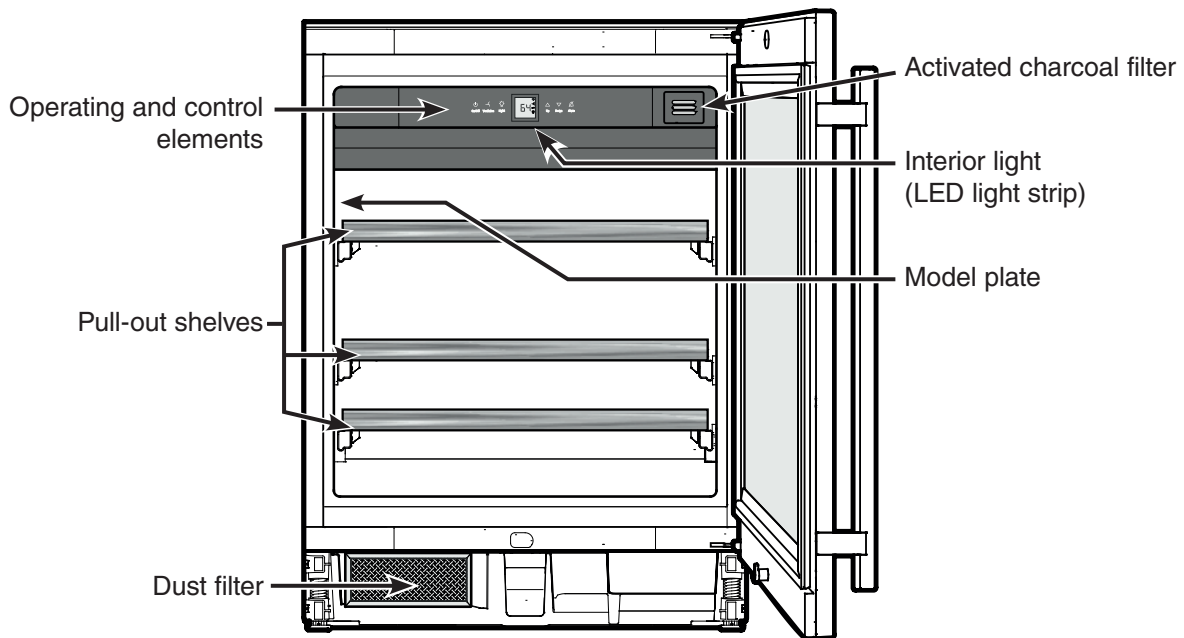

Operating and Control Elements



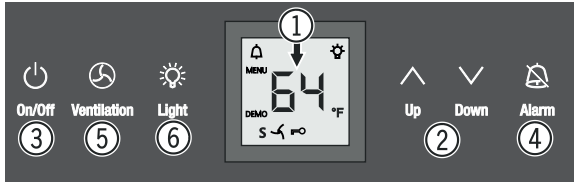

The electronic control panel features "touch capacitive technology". Any function can be activated by touching the corresponding icon.

The exact contact point is between the symbol and its label 



- ① Temperature display
- ② Temperature setting buttons
- ③ On/Off button (switching the appliance on and off)
- ④ Audible alarm Off button
- ⑤ Fan switch
- ⑥ Interior light On/Off button

Symbols in the display

-  Alarm (symbol flashes if the temperature inside the appliance is too high or too low)
- DEMO** Demo mode is activated
- S** Sabbath mode is activated
- MENU** Setup mode is activated (activating the child lock, adjusting the display brightness and activating the Sabbath mode)
-  The interior fan runs constantly
-  Child lock is activated
-  The interior light is switched on continuously

Switching the Appliance On and Off

Switching the appliance on

Press the **On/Off** button until the temperature display lights up.



Switching the appliance off

Keep the **On/Off** button pressed for approx. 3 seconds until the temperature display goes out.

Setting the Temperature

Reducing the temperature

Press the **Down** button.



Increasing the temperature

Press the **Up** button.

Up Down

- When pressing one of the buttons for the first time, the display will start to flash.
- Pressing this button again enables you to change the temperature setting.
- The electronic control system will switch over automatically about 5 seconds after the last time you pressed the button, and the actual temperature will be displayed.

The temperature can be set at between 41°F and 68°F.

Storing Wine

If you are storing wine for long periods of time, it should be stored at a temperature of between 50°F and 54°F (10°C and 12°C).

This is the temperature wine cellars are kept at, and it is just right to allow wine to mature properly.

The following drinking temperatures are recommended for the various types of wine.

- Red wines **57°F to 68°F** (14°C to 20°C)
- Rosé wines **50°F to 54°F** (10°C to 12°C)
- White wines **46°F to 54°F** (8°C to 12°C)
- Sparkling wines **44°F to 48°F** (7°C to 9°C)
- Champagne **41°F to 44°F** (5°C to 7°C)

OPERATION

Door Open Alarm

If the door is left open for more than 180 seconds, the audible alarm signal will sound.

If the door must be opened for a lengthy period in order to place items into the appliance, cancel the audible alarm signal by pressing the **Alarm** button. 

The alarm switches back to standby when the door is shut.

Temperature Alarm

If the temperatures in the interior are out of the permitted range, the audible alarm signal will sound and the temperature display will flash.

- Cancel the audible alarm signal by pressing the **Alarm** button.

After a lengthy power failure, the temperature in the interior may have risen to a too high level. After the power supply is restored, the drop in temperature can be watched on the display.

The temperature display will stop flashing as soon as the temperature in the interior has reached the set value.

Temperature alarm after a fault in the appliance

If a fault occurs in the appliance, the temperature in the interior may rise too high or drop too low. The audible alarm signal will sound and the temperature display will flash.

- Cancel the audible alarm signal by pressing the **Alarm** button.

If the temperature displayed is too high (warm), first check whether the door is closed correctly.

If the temperature display continues to show a value that is too high or too low after one hour, contact the customer service department.

If **F1** appears in the display, a fault has occurred in the appliance.

In this case, contact the customer service department.

Ventilation Button

The interior fan ensures a constant and even interior temperature and a suitable climate for wine storage.

The humidity in the appliance can be increased even further by pressing the **Ventilation** button. This has a particularly positive effect for long-term storage.

The increased level of humidity prevents the corks from drying out.

To switch on

Press the **Ventilation** button - the symbol  lights up.

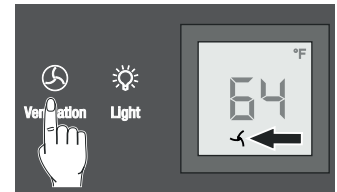

Setup Mode

In the setup mode, you can activate the following functions:

= Sabbath mode

This feature considers the religious requirements on the Sabbath or holidays. When the Sabbath mode is active, some functions of the electronic controls are switched off.

- The lighting remains off.
- The cooling fan remains in its actual state: If it is on, it remains on, if it is off, it remains off.
- There is no door alarm.
- There is no temperature alarm.

= Display brightness

Used to adjust the display brightness

= Temperature display mode



You can choose the **unit of temperature** for the display in degrees Fahrenheit or degrees Celsius.

= Child lock

The child lock is designed to protect the appliance from being switched off and the temperature setting from being changed accidentally.

5 = Sabbath mode

Activating the Sabbath mode

Press  for 5 seconds. Display = 



Press  Display = 

Press  Display = 

Press  Display = 

The Sabbath Mode is now activated.

Deactivating the Sabbath mode

Press  for 5 seconds. Display = 

Press  Display = 



Press  Display = 

Press  = Exit setup mode.

The appliance will change back to normal operation.

h = Display brightness

Adjusting the display brightness

Press  for 5 seconds. Display = 

Press  Display = 

Press  Display = 

Use buttons **Up** and **Down** to select the desired setting.

h0 = display lighting off
h1 = minimum brightness
h5 = maximum brightness

Press  Display = 

Press  = Exit setup mode.

The appliance will change back to normal operation.

The adjusted brightness will be activated after one minute.

Note



If a button is pressed, the display lights up for one minute at maximum brightness.

OPERATION

□ = Temperature display mode

Note

The factory setting is degrees Fahrenheit.

Press  for 5 seconds. Display = 

Press  Display = 

Press  Display = 

Press  Display = 

Press  Display = 

Press  = Exit setup mode.

The appliance will change back to normal operation.



The temperature reading is now displayed in degrees Celsius.

Note

To change the temperature display back to degrees Fahrenheit, follow the steps above.

⌂ = Child lock

Activating the child lock

Press  for 5 seconds. Display = 

Press  Display = 



Press  Display = 

Press  Display = 

Press  = Exit setup mode.

The appliance will change back to normal operation.

Deactivating the child lock

Press  for 5 seconds. Display = 

Press  Display = 

Press  Display = 

Press  Display = 

Press  = Exit setup mode.

The appliance will change back to normal operation.

WINE COOLER COMPARTMENT

Interior light

The interior light will always switch on when the appliance door is opened.

The interior light will go out approx. 5 seconds after the door is closed.

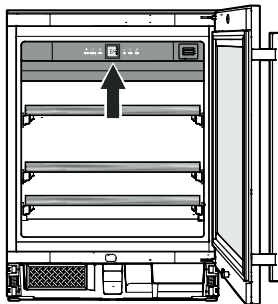

Press the **Light** button if you want the interior light to be on even when the door is closed.



Furthermore, the brightness of the lighting can be adjusted.

- Press the **Light** button.
- Press and hold the **Light** button and at the same time press the temperature setting buttons to increase or decrease the brightness.



The light intensity of the LED light corresponds to laser class 1/1M.

IMPORTANT

The light cover may only be removed by customer service staff.



Risk of eye damage.

If the cover is removed, do not look directly at the light through optical lenses from close distance.

Air Exchange with Activated Charcoal Filter

The way in which wines continue to age depends on the ambient conditions.

The quality of the air is therefore decisive for preserving the wine.

We recommend that you replace the filter illustrated here once a year. Filters can be obtained from your dealer.

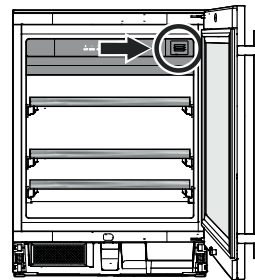

Changing the filter

- Push in the filter and release it again.



- Pull out the filter.

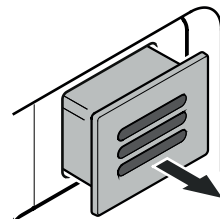

- Remove the back part of the filter.

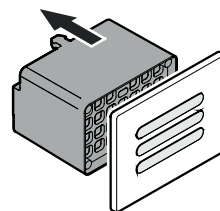

- Fit the new filter to the cover.

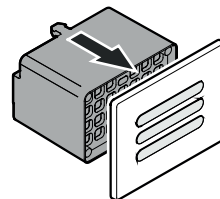

- Insert the filter, push it in as far as it will go and then release it again.

The filter is automatically locked into place.

You will hear a click.



WINE COOLER COMPARTMENT

Additional Features

Pull-out shelves

The pull-out shelves allows bottles of wine to be viewed and removed more easily.

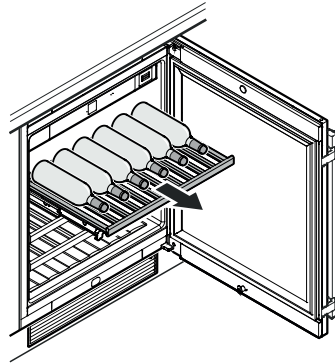

Labels

The appliance is supplied with one label for each wooden shelf.

Use these to label the type of wine stored on each shelf.

Additional labels can be obtained from your dealer.

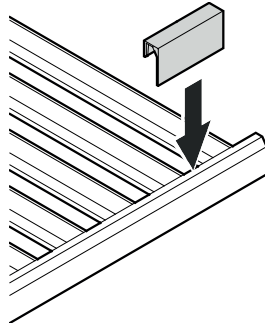

Bottle holders

Fit the supplied bottle holders to store four additional bottles at the outer edges of the upper two wooden shelves.

Install the bottle holder between the bars of the shelves at an angle and twist until it clicks into place.

Then slide the bottle holder to the position shown in the illustration.

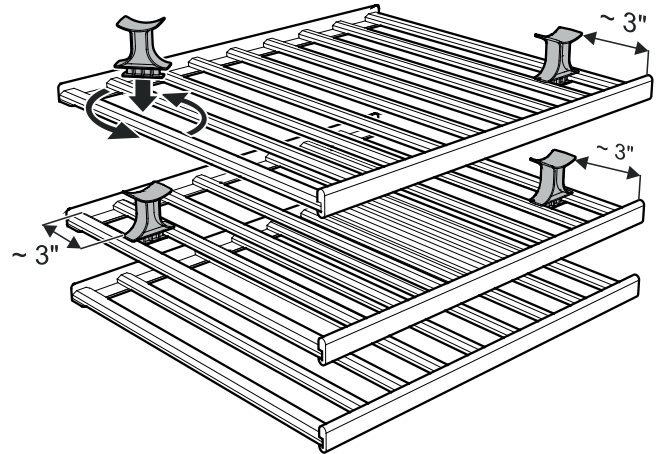

Presenting wine bottles

To present wine bottles, install the bottle holder in any position in the upper two wooden shelves.

For 0.75 l Bordeaux bottles, observe the distance shown in the illustration, otherwise the bottle will touch the shelf above.

When storing taller (longer) bottles, slide the bottle holder towards the back of the shelf accordingly.

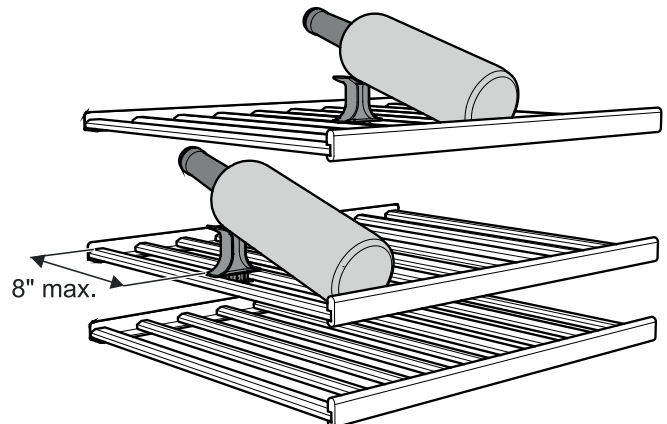

Storage diagram

for 0.75 l Bordeaux bottles

These bottles rest on the respective bottle holder.

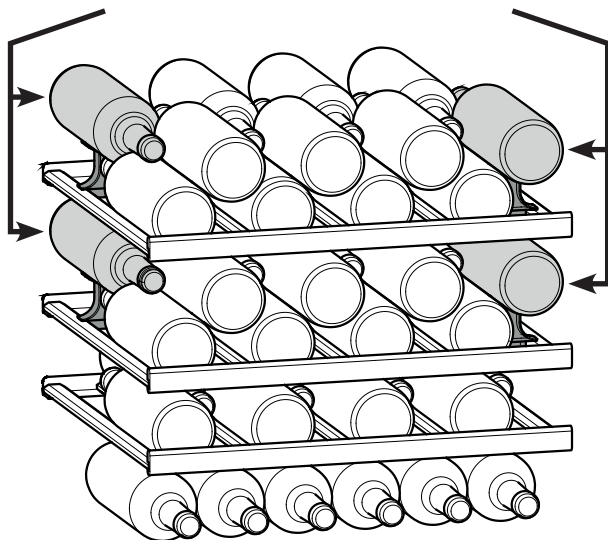

Total 46 bottles

IMPORTANT

The maximum load per wooden shelf is 55 lbs (25 kg).

Safety Lock

The lock in the appliance door is equipped with a safety mechanism.

Locking the appliance

- Insert the key and push as shown by arrow **1**.
- Turn the key 90° clockwise **2**.

Unlocking the appliance

- Insert the key and push.
- Turn the key 90° counterclockwise.

Note

Hold the key at all times. The lock cylinder is spring loaded and will eject the key if released from your grip.

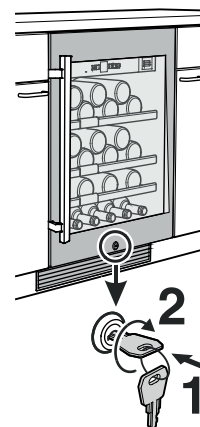

! WARNING!

Risk of child entrapment and suffocation due to a locked appliance door.

Keep the key in a safe place out of reach of children and not in the vicinity of the appliance.

CLEANING

Cleaning

⚠ WARNING!

- To prevent possible injury due to an electrical shock, be sure to disconnect the power cord or turn off the circuit breaker before cleaning the appliance.
- To avoid injury or damage, do not use steam cleaning equipment to clean the appliance.

IMPORTANT

Mold can form on the bottles and labels depending on the type of adhesive used on the labels. This can be prevented by carefully cleaning any adhesive residues off the bottles.

Cleaning the appliance outside

- Clean the door surface with a clean and soft cloth. If necessary, use a moist cloth (water + detergent).
- Use a glass cleaner to clean the glass surface.

IMPORTANT

Do not use abrasive or scouring pads or sponges. Do not use concentrated cleaning agents. Never use abrasive or acid-based cleaners or chemical solvents.

The dust filter in the appliance base must be cleaned at least once a year.

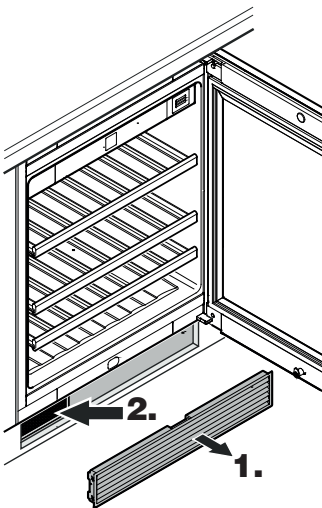

1. Remove the ventilation grille from the toe kick panel.
2. Clean the dust filter using a vacuum cleaner.
3. Reattach the ventilation grille.

Cleaning the appliance interior

The wooden shelves can be removed for easier cleaning of the inside of the appliance.

Removing the wooden shelf

Pull the wooden shelf upwards on the right and left at the back (release) and then remove it towards you.

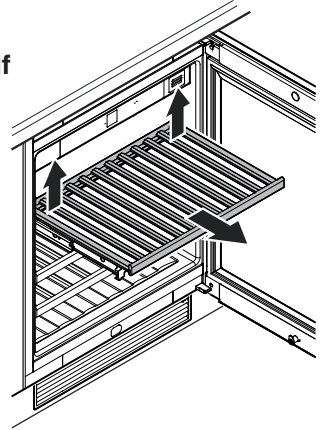

- Clean the inside of the appliance with lukewarm water and a little detergent.
- Thoroughly dry all parts with a cloth.
- **Do not** damage or remove the model plate on the inside of the appliance. It is very important for servicing your appliance.

Inserting the wooden shelf

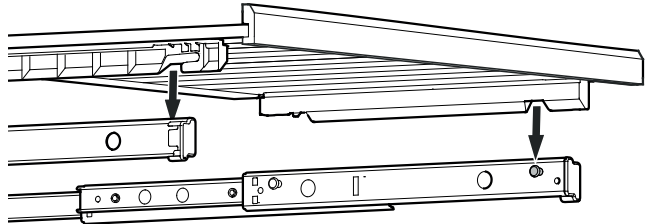

Extend the pull-out rails as far as they will go. Place the front recesses of the wooden shelf on the securing pins.

Slide the wooden shelf together with the pull-out rails into the appliance as far as they will go.

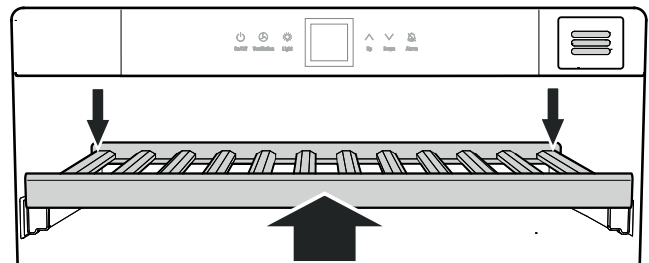

Push the wooden shelf right to the back so that it clicks into place at the front.

Push the wooden shelf downwards on the right and left at the back and click into place.

Your appliance is designed and manufactured for a long life and reliable operation.

If a problem occurs during operation, check whether it is due to an operating error.

Please note that even during the warranty period, you may be responsible for certain repair costs.

Problem	Possible cause and remedy
Appliance does not work, display is off.	<ul style="list-style-type: none"> - Is the appliance turned on? - Is the power cord properly inserted in the outlet? - Is the circuit breaker or fuse in working order?
Motor seems to run too long.	<ul style="list-style-type: none"> - Is the ambient temperature too hot? See Safety Regulations. - Has the appliance been opened too often or left open too long?
The temperature is not cold enough.	<ul style="list-style-type: none"> - Is the temperature setting correct? See Setting The Temperature. - Has an excessive amount of wine been placed in the appliance? - Does a separately installed thermometer show the correct reading? - Is the ventilation system working properly? - Is the dust filter in the appliance base soiled? See section entitled "Cleaning". - Is the appliance set up too close to a heat source?
The fans inside the appliance are running even though the fan function has been deactivated and the compressor (refrigeration unit) is idle.	<ul style="list-style-type: none"> - This is a normal operating state depending on the set interior temperature and ambient temperature at the place of installation.
F1 appears in the display	<ul style="list-style-type: none"> - A fault has occurred in the appliance. Contact the Liebherr Service Center.
When inserting the mains plug, the refrigeration unit does not switch on, but a value is shown in the temperature display.	<ul style="list-style-type: none"> - Demo mode is activated. Contact the Liebherr Service Center.

Customer Service

If none of the above possible causes apply, and you can not rectify the fault yourself, contact the Liebherr Service Center. Indicate the type **(1)** of appliance, service number **(2)** and the appliance / serial number **(3)** as shown on the model plate.

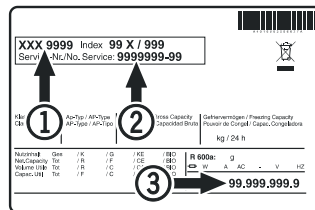

The position of the model plate is shown in the section entitled **Description of the Appliance**.

Appliance information

Record this information when the appliance is installed.

Type Designation: _____

Service Number: _____

Appliance / Serial Number: _____

Date of Purchase: _____

Where Purchased: _____

Turning Off the Appliance

If your appliance is to be turned off for any length of time, switch it off and disconnect the plug or switch off or unscrew the fuse.

Clean the appliance and leave the door open in order to prevent unpleasant odors.

For Service in the U.S.

Liebherr Service Center

Toll Free: **1-866-LIEBHER** or **1-866-543-2437**

Email: Service-appliances.us@liebherr.com

PlusOne Solutions, Inc.

3501 Quadrangle Blvd, Suite 120

Orlando, FL 32817

For Service in Canada

Liebherr Service Center

Toll Free: **1-888-LIEBHER** or **1-888-543-2437**

www.euro-parts.ca

EURO-PARTS CANADA

39822 Belgrave Road

Belgrave, Ontario, N0G 1E0

Phone: (519) 357-3320

Fax: (519) 357-1326



www.liebherr-appliances.com