

LIEBHERR

Use and Care Manual

Multi-temperature wine cabinet
with freezer compartment, built-in

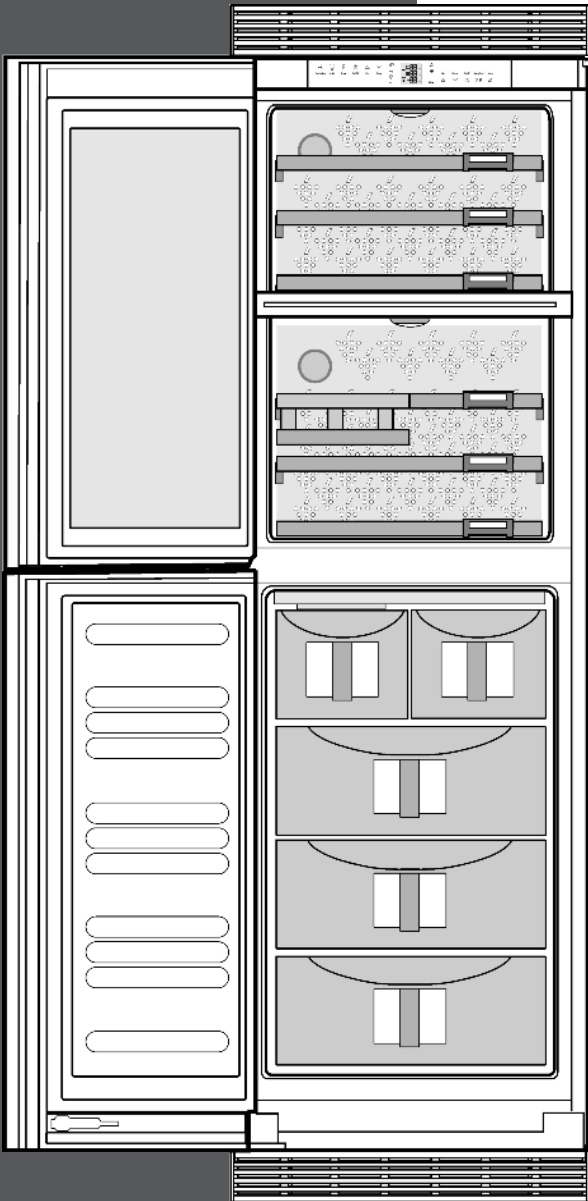

WF1061/ WFI1061
170510 7084306 - 01

The appliance at a glance

Contents

1	The appliance at a glance.....	2
1.1	Additional benefits.....	2
1.2	Overview of the appliance and its equipment	3
1.3	Range of appliance use.....	3
1.4	Conformity.....	3
1.5	Energy saving.....	3
2	General safety information.....	3
3	Controls and displays.....	4
3.1	Operating and control elements.....	4
3.2	Temperature display.....	4
4	Start-up.....	5
4.1	Transporting the appliance.....	5
4.2	Setting up the appliance.....	5
4.3	Disposal of packaging.....	5
4.4	Connecting the appliance.....	6
4.5	Switching on the appliance.....	6
5	Operation.....	6
5.1	Temperature display unit.....	6
5.2	Brightness of the temperature display.....	6
5.3	Child-proof lock.....	7
5.4	Door alarm.....	7
5.5	Temperature alarm.....	7
5.6	Sabbath Mode.....	7
5.7	Freezer compartment.....	8
5.8	Wine cooling zone.....	10
6	Maintenance.....	11
6.1	Replacing the active carbon filter.....	11
6.2	Replacing the water filter.....	11
6.3	Defrosting with NoFrost.....	12
6.4	Cleaning the appliance.....	12
6.5	Cleaning the IceMaker.....	13
6.6	Customer service.....	13
6.7	Appliance Information.....	13
7	Troubleshooting.....	14
8	Putting appliance out of service.....	16
8.1	Vacation Tips.....	16
8.2	Switching off the appliance.....	16
8.3	Decommissioning	17
9	Disposing of the appliance.....	17
10	Liebherr Warranty Plan.....	17

Congratulations on the purchase of your new appliance. With this purchase, you have chosen all the advantages of the latest refrigeration technology, guaranteeing you a high-quality appliance with a long life span and high operating safety.

The equipment of your appliance gives you the highest level of day-to-day ease of operation.

Together we are making an active contribution to the conservation of our environment by purchasing this appliance which is manufactured in an environmentally friendly process with the use of recyclable materials.

We hope you enjoy your new appliance.

The manufacturer is constantly working to improve all models. Therefore please understand that we reserve the right to make design, equipment and technical modifications.

To get to know all the benefits of your new appliance, please read the information contained in these instructions carefully.

The instructions apply to several models, so there may be differences. Sections which only apply to certain appliances are indicated with an asterisk (*).

Instructions for action are marked with a ►, the results of action are marked with a ▷.

1 The appliance at a glance

1.1 Additional benefits

- CFC free
- Energy-optimized refrigerant circuit
- Energy-efficient insulation
- Low energy consumption
- User-friendly electronic controls
- Active function indicators
- Temperature can be controlled in the appliance independent of ambient conditions according to its climate rating - Temperature can be displayed as °C or °F
- The appliance defrosts automatically - no need to spend time defrosting
- Large freezing capacity
- Shelves can be removed to make space for large items.
- Freezer over-temperature alarm
- Quick-freeze feature for fresh food (SuperFrost)
- Frozen food temperature indicator
- Power failure/"frost-control" display
- All freezer drawers suitable for quick-freeze
- Bright LED interior light
- Door ajar alarm
- Handle grips on all extra-large drawers for easy transport
- Integrated transport grips on appliance housing
- Transport castors at back
- Easy to clean
- Door hinges can be reversed
- Soft stop mechanisms on both doors
- This unit is certified as Sabbath compliant by the Star-K organization thus allowing the appliance to be used during religious holidays. For more information please visit Star-K on the web at www.star-k.org.



1.2 Overview of the appliance and its equipment

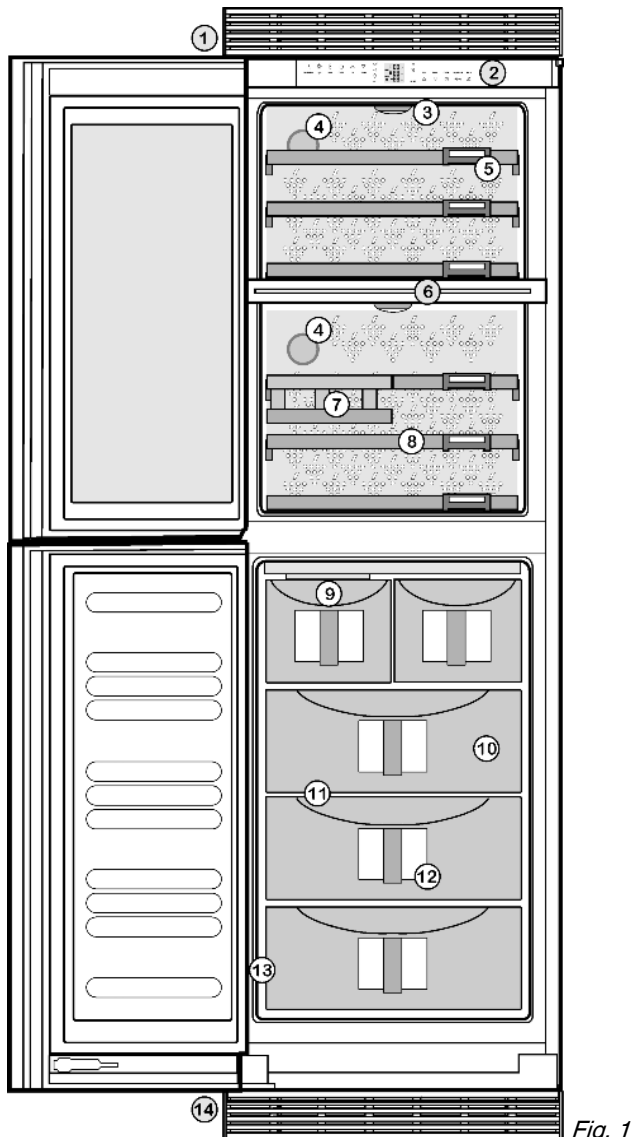

Fig. 1

- | | |
|---------------------------------------|---|
| (1) Rear transport handles | (8) Wooden shelf, fixed |
| (2) Operating and control elements | (9) IceMaker |
| (3) Internal LED light | (10) Freezer compartment |
| (4) Active carbon filter, replaceable | (11) VarioSpace |
| (5) Description label | (12) InfoSystem |
| (6) Separating plate with sealing lip | (13) Rating plate |
| (7) Wooden shelf, hinged | (14) Adjustable feet, front transport handles, rear transport castors |

1.3 Range of appliance use

The appliance is suited exclusively for storing wine and/or food.

In the case of commercial food cooling, the pertinent statutory regulations have to be observed. The appliance is not suited for storing and cooling pharmaceuticals, blood plasma, laboratory preparations or similar substances and products subject to the CMDCAS and FDA 510(k). Any misuse of the appliance may result in damage to or spoilage of the stored goods. Furthermore, the appliance is unsuited for use in areas exposed to an explosion hazard.

The appliance is set to operate within specific ambient temperature limits according to its climate rating. The climate rating for your appliance is printed on the rating plate.

Note

- Compliance with the specified ambient temperatures is required, otherwise the refrigeration performance is reduced.

Climate rating	for ambient temperatures from
SN	50 °F (10 °C) to 90 °F (32 °C)
N	61 °F (16 °C) to 90 °F (32 °C)
ST	61 °F (16 °C) to 101 °F (38 °C)
T	61 °F (16 °C) to 110 °F (43 °C)

1.4 Conformity

The refrigerant circuit has been tested for leaks. The appliance complies with the relevant safety regulations and the directives UL250 and CAN/CSA C22.2 No.63-93.

As there are currently no energy efficiency guidelines for wine coolers, wine compartments are rated as cellar compartments in the energy efficiency classification.

1.5 Energy saving

- Always ensure good ventilation. Do not obstruct ventilation openings or grilles.
- Do not install the appliance in direct sunlight or next to an oven, heater, or similar heat source.
- Energy consumption depends on installation conditions such as the ambient temperature (see 1.3).
- Avoid opening the appliance door for any longer than necessary.

2 General safety information

Read and follow these instructions. They contain safety advice which is important for safe and problem-free installation and operation. Always read and follow the safety advice.

Dangers for the user:

- This appliance is not designed for persons (or children) with physical, sensory or mental impairment or persons who do not have sufficient experience and knowledge, unless they have been instructed in the use of the appliance by a person who is responsible for their safety

Controls and displays

and supervised at first. Supervise children so that they do not play with the appliance.

- In the event of power failure, disconnect the power plug (do not pull on the power cord to do this) or switch off the fuse.
- Repairs, work on the appliance and replacement of the power cord should only be carried out by the customer service department.
- When disconnecting the appliance from the outlet, always take hold of the plug. Do not pull on the cable.
- The appliance should only be assembled and connected in accordance with the instructions.
- Please keep the instructions and pass them on to any future owner.
- All repairs to or work on the IceMaker must only be carried out by the customer service department or other specialist engineers trained to do this.
- The manufacturer is not liable for damage arising from incorrect connection to the water supply.

Risk of fire:

- Do not operate the appliance near explosive gases.
- Do not store explosive materials or spray cans with flammable propellants, such as e.g. butane, propane, pentane, etc. in the appliance. You can recognize such spray cans by the printed contents or a flame symbol. Any leaking gasses can be ignited by electrical components.
- Do not place burning candles, lamps and other objects with an open flame on the appliance.
- High-proof alcohol should only be stored tightly sealed and standing upright. Any leaking alcohol could be ignited by electrical components.

Tipover hazard:

- Do not stand or climb on the plinth, drawers, doors, etc. This applies in particular to children.
- Do not use this appliance until installation is completed fully.

Risk of food poisoning:

- Do not consume food that has passed its best before date.



Danger of frostbite, feelings of numbness and pain:

- Avoid continued skin contact with the cold surfaces or chilled/frozen food or adopt protective measures, e. g. use gloves. Do not consume ice cream (especially sherbets) and ice cubes immediately when they are too cold.

Risk of crushing

- Do not reach into the soft stop mechanism. Fingers may be trapped when the door is closed.

Follow the specific instructions in the other sections:

	DANGER	indicates a hazardous situation, which if not avoided, will result in death or serious injury.
	WARNING	indicates a hazardous situation, which if not avoided, could result in death or serious injury.

	CAUTION	indicates a hazardous situation, which if not avoided, will result in minor or moderate injury.
	NOTICE	indicates a hazardous situation, which if not avoided, could result in damage to property.
	Note	indicates useful advice and tips.

3 Controls and displays

3.1 Operating and control elements

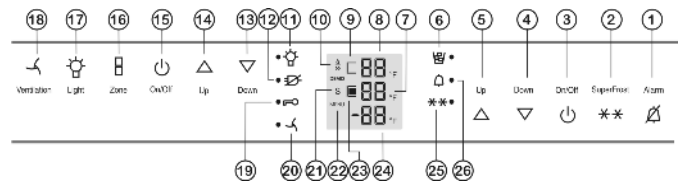



Fig. 2

- | | |
|--|--|
| (1) Alarm button | (14) Wine cooling zone Up button |
| (2) SuperFrost button | (15) Wine cooling zone On/Off button |
| (3) Freezer compartment On/Off button | (16) Zone button |
| (4) Freezer compartment Down button | (17) Light button |
| (5) Freezer compartment Up button | (18) Ventilation button |
| (6) IceMaker symbol | (19) Child safety symbol |
| (7) Temperature display for bottom wine cooling zone | (20) Ventilation symbol |
| (8) Temperature display for top wine cooling zone | (21) Sabbath Mode symbol |
| (9) Top wine cooling compartment symbol | (22) Menu symbol |
| (10) Filter symbol | (23) Bottom wine cooling compartment symbol |
| (11) Light symbol | (24) Freezer compartment temperature display |
| (12) Power failure symbol | (25) SuperFrost symbol |
| (13) Wine cooling zone Down button | (26) Alarm symbol |

 The exact contact point is between the symbol and its label

3.2 Temperature display

The following is displayed in normal operation:

- the average wine cooling temperature
- the highest freezer temperature

The freezer compartment temperature display is flashing:

- the temperature setting has been changed
- after switch-on the temperature is not yet cold enough

- the temperature has risen several degrees
- The wine zone temperature display is flashing:
- the temperature setting has been changed
 - after switch-on until the set temperature is reached
 - the wine cabinet temperature is too cold/too warm
- Dashes are shown on the display:
- the freezer temperature is above 32 °F (0 °C).
- The following displays indicate malfunction. Possible causes and corrective actions: (see Troubleshooting).
- F0 through F9
 - FE
- The LED of the symbol for power failure  lights up.

4 Start-up

4.1 Transporting the appliance



CAUTION

Risk of injury or damage if incorrectly transported.

- ▶ Transport the appliance in its packaging.
- ▶ Transport the appliance upright.
- ▶ Do not move the appliance on your own.



WARNING

There is a risk of injury from pieces of broken glass. If transported to above 4921 ft (1500 m), the glass in the door may break. The edges of the broken pieces will be sharp and may cause serious injury.

- ▶ Adopt suitable protective measures.

4.2 Setting up the appliance



WARNING

Risk of fire due to moisture!

If live parts or the power cord get wet, this can cause a short circuit.

- ▶ The appliance is designed for use in enclosed spaces. Do not operate the appliance in open space or in damp areas or where there is spray.



WARNING

Danger of fire and damage!

- ▶ Do not place devices that give off heat, e.g. microwaves, toasters, etc. on the appliance.



CAUTION

Risk of personal injury!

- ▶ Have two people move this appliance into place.

NOTICE

Risk of damage caused by condensation

Installing the appliance next to any other refrigerator or freezer can cause condensation or damage to the Liebherr appliance.

- ▶ Do not install this appliance next to any other refrigerator or freezer except another Liebherr model. Liebherr models are designed to allow side-by-side installation. They are equipped with a heating system to eliminate condensation when refrigerators or freezers are installed side-by-side.

NOTICE

Risk of damage for the finished floor surface!

- ▶ Protect the finished floor surface before you uncrate the unit.

Verify that:

- The floor under the appliance is flat and level.
 - The floor can support the appliance's weight plus approximately 1200 pounds (544 kg) of food weight.
 - The appliance is not placed in direct sunlight or near the stove, range top, radiators and similar heat sources.
 - The kitchen cabinet that the appliance is installed in is shimmed to the floor level if the floor heights are not equal.
 - Cutout dimensions are accurate.
 - Electrical outlet is in correct location.
 - The air flow is not restricted. Air flow must be provided for the appliance to operate properly. The factory air vents provide 31 square inches (200 cm²) of air flow per appliance. If you are replacing the air vents with an overlay, the air flow must be the same or greater than the factory air vents.
 - ▶ Examine the unit and packaging for shipping damage. Contact the carrier immediately if you suspect there is any damage.
 - ▶ Note the type (model, number), index, appliance/serial number, date of purchase and where purchased (see 6.7).
 - ▶ Remove anything attached to the rear or side walls of appliance that would prevent proper installation or impede proper ventilation.
- If the appliance is set up in humid areas, condensation may build on the outside of the appliance.
- ▶ Always ensure proper ventilation.
 - ▶ Assemble appliances according to separate installation instructions.

4.3 Disposal of packaging



WARNING

Danger of suffocation from packaging materials and films!

- ▶ Do not allow children to play with packaging materials.

The packaging is made from recyclable materials:

- Corrugated card/cardboard
- Preformed pieces from foamed polystyrene



Operation

- Films and bags from polyethylene
- Packing bands from polypropylene
- Wood frame nailed together with a polyethylene window
- ▶ Take the packaging material to an official collection point.

4.4 Connecting the appliance



WARNING

Electrical shock hazard!

- ▶ Start-up should only take place once the appliance has been installed according to these instructions.
- ▶ Electrically ground appliance.
- ▶ Do not ground to a gas pipe.
- ▶ Check with a qualified electrician if you are not sure the appliance is properly grounded.
- ▶ Do not have a fuse in the neutral or grounding circuit.
- ▶ Do not use an extension cord, power bar or a multiple socket adapter.
- ▶ Do not use a power cord that is frayed or damaged.



WARNING

Electrical shock hazard!

This appliance is equipped with a three-prong (grounding) polarized plug for your protection against possible shock hazards. Electrical Grounding Required.

- ▶ Do not remove the round grounding prong from the plug.
- ▶ Do not use a two-prong grounding adapter.

- Wait 1 hour after installation before you plug in the appliance. This allows the refrigerant and system lubrication to reach equilibrium.
- Make sure incoming voltage is the same as the appliance rating. A 110-120 Volt, 60 Hz, 15 Amp electrical supply (20 Amp for side-by-side installations) circuit that is controlled by a circuit breaker or fuse is required.
- We recommend using a dedicated circuit for this appliance to prevent electrical overload.
- Follow all Federal, State and local electrical, fire and building codes and ordinances when installing the receptacle and / or the appliance.
- In some communities, a wall switch is required to turn power to the appliance ON and OFF.
- To reduce the risk of fire, electric shock, or personal injury, installation work and electrical wiring must be done by a qualified electrician in accordance with all applicable codes and standards, including fire-rated construction.
- You are advised to clean the appliance before switching it on the first time (see 6.4).
- The top of the electric outlet must be located within 82-5/8 in. (2100 mm) from the top of the base in the cabinet.

4.5 Switching on the appliance

Note

- ▶ To switch on the entire appliance, only the freezer compartment needs to be switched on.

4.5.1 Switching on the freezer compartment

- ▶ Press On/Off button, freezer compartment *Fig. 2 (3)*.
- ▷ The temperature display for the wine cooling zone and the Alarm symbol will flash until the set temperature is reached.
- ▷ The freezer compartment temperature display and the Alarm symbol will flash until the temperature is cold enough. If the temperature is greater than 32 °F (0 °C), flashing dashes will appear; if the temperature is lower than this, the current temperature will flash on the display.

4.5.2 Switching on the wine cooling zone

- ▶ Press Wine cooling zone On/Off button *Fig. 2 (15)*.
- ▷ The temperature display for the wine storage zone and the Alarm symbol will flash until the set temperature is reached.

5 Operation

5.1 Temperature display unit

The temperature display can be changed from °F to °C.

5.1.1 To change the unit

- ▶ Activate setting mode: Press SuperFrost button *Fig. 2 (2)* for about 5 seconds.
- ▷ The SuperFrost button *Fig. 2 (2)* will flash.
- ▷ 5 is displayed in the temperature display.
- ▶ Using Freezer compartment Up button *Fig. 2 (5)*/ Freezer compartment Down button *Fig. 2 (4)* select °.
- ▶ To confirm: Briefly press SuperFrost button *Fig. 2 (2)*.
- ▶ Using Freezer compartment Up button *Fig. 2 (5)*/ Freezer compartment Down button *Fig. 2 (4)* select °F or °C.
- ▶ To confirm: Briefly press SuperFrost button *Fig. 2 (2)*.
- ▶ To exit setting mode: Press Freezer compartment On/Off button *Fig. 2 (3)*.



-or-

- ▶ Wait 5 minutes.

- ▷ The temperature is again displayed in the temperature display.

5.2 Brightness of the temperature display

You can adapt the brightness of the temperature display to the light conditions in the room in which it is installed.

5.2.1 Setting the brightness

The brightness can be set between $\kappa 0$ (minimum luminosity) and $\kappa 5$ (maximum luminosity).

► To activate setting mode: Press SuperFrost button *Fig. 2 (2)* for about 5 seconds.

▷ 5 is shown on the display.

▷ The Menu symbol *Fig. 2 (22)* lights up.

► Press Freezer compartment Up button *Fig. 2 (5)* or Freezer compartment Down button *Fig. 2 (4)* to select κ .

► To confirm: Briefly press SuperFrost button *Fig. 2 (2)*.

► To set the display brighter: Press Freezer compartment Up button *Fig. 2 (5)*.

► To set the display darker: Press Freezer compartment Down button *Fig. 2 (4)*.

► To confirm: Press SuperFrost button *Fig. 2 (2)*.

▷ The brightness is set to the new value.

► To deactivate setting mode: Press Freezer compartment On/Off button *Fig. 2 (3)*.

-or-

► Wait 5 minutes.

▷ The temperature is again displayed in the temperature display.



5.3 Child-proof lock

You can use the child-proof lock to lock the buttons. This means that children cannot accidentally switch off the appliance when playing.

5.3.1 Switching on the child-proof lock

► Activate setting mode: press and hold the SuperFrost button *Fig. 2 (2)* for approximately 5 s.

▷ 5 is shown on the display.

▷ The Menu symbol *Fig. 2 (22)* lights up.

► Using the Freezer compartment Up button *Fig. 2 (5)* or Freezer compartment Down button *Fig. 2 (4)*, select κ .

► Press the SuperFrost button *Fig. 2 (2)* briefly to confirm. When $\kappa 1$ is shown on the display:

► To switch on the child-proof lock, press the SuperFrost button *Fig. 2 (2)* briefly.



▷ The Child lock symbol *Fig. 2 (19)* LED lights up. κ flashes on the display.

When $\kappa 0$ is shown on the display:

► To switch off the child-proof lock, press the SuperFrost button *Fig. 2 (2)* briefly.

▷ The Child safety symbol *Fig. 2 (19)* LED goes out. κ flashes on the display.

► Deactivate setting mode: press the Freezer compartment On/Off button *Fig. 2 (3)*.

-or-

► Wait 5 min.

▷ The temperature is again displayed on the temperature display.

5.4 Door alarm

If the door is open for longer than 180 seconds, the acoustic warning sounds.

The acoustic warning stops automatically when the door is closed.

5.4.1 Switching off the door alarm

The acoustic warning can be switched off when the door is open. The acoustic warning remains switched off as long as the door is open. When the door is closed, the alarm function is active again.

► Press Alarm button *Fig. 2 (1)*.

▷ The door alarm stops.

5.5 Temperature alarm

If the freezer temperature is not cold enough, the audible warning sounds.

If the wine storage temperature is too warm or too cold, the audible warning sounds.

At the same time, the temperature display and the Alarm symbol *Fig. 2 (26)* LED will flash.

The cause of a temperature being too high may be:

- When sorting and removing food from the appliance, too much warm ambient air got in.
- The power was cut off for a while.
- The appliance is faulty.

The audible warning automatically ceases, the Alarm symbol *Fig. 2 (26)* goes out, and the temperature display stops flashing when the temperature is cold/warm enough again.

If the alarm status remains: (see Troubleshooting).

Note

If the temperature is not cold enough, food may spoil.

► Check the quality of the food. Do not consume spoiled food.

5.5.1 Switching off the temperature alarm

The acoustic warning can be switched off. When the temperature is cold enough again, the alarm function is active again.

► Press Alarm button *Fig. 2 (1)*.

▷ The acoustic warning ceases.

5.6 Sabbath Mode

After entering Sabbath Mode, you do not have to worry about lights, digits, icons, tones, alarms or fans. The defrost cycle operates solely on clock time without any feedback from usage of the refrigerator. After a power failure, the appliance will return to Sabbath Mode without requiring additional input.

Operation



WARNING

Danger of food poisoning!

No record will be kept of a power failure during Sabbath Mode. Thus, during Sabbath mode, if a power failure occurs that you are not aware of, when the power comes back on, the unit will continue to be in Sabbath Mode but when Sabbath Mode is ended there will be no indication that a power failure occurred

If a power failure occurs during Sabbath mode:

► Check the quality of the food. Do not consume spoiled food!

- No control operations are possible other than switching off Sabbath Mode.
- If the unit is currently running in a mode such as Superfrost, Supercool or the Ventilation is enabled these functions will continue and finish their timed cycles independent of now being in Sabbath mode.
- The Ice Maker is disabled.
- No audible signals are emitted, and the temperature display does not indicate any warnings or settings (such as a temperature alarm or door alarm).

5.6.1 Setting Sabbath mode

► To activate setting mode: Press and hold the SuperFrost button *Fig. 2 (2)* for approx. 5 s.

▷ 5 flashes on the display.

▷ The Menu symbol *Fig. 2 (22)* lights up.

► To access the Sabbath mode function: Briefly press the SuperFrost button *Fig. 2 (2)*.

When 51 is shown on the display:

► **To turn on** Sabbath mode, briefly press the SuperFrost button *Fig. 2 (2)*.

When 50 is shown on the display:

► **To turn off** Sabbath mode, briefly press the SuperFrost button *Fig. 2 (2)*.

► To deactivate setting mode: Press the Freezer compartment On/Off button *Fig. 2 (3)*.

-or-

► Wait 5 min.

▷ The Sabbath Mode symbol *Fig. 2 (21)* appears on the temperature display as long as Sabbath Mode is active.

▷ Sabbath mode switches off automatically after 120 hours if it is not manually switched off beforehand.

5.7 Freezer compartment

You can store frozen food, make ice cubes and freeze fresh food in the freezer compartment.

5.7.1 Freezing food

The maximum number of kilograms of fresh food that can be frozen within a 24-hour period is indicated on the rating plate under "Freezing capacity ... kg/24h".

Each drawer can hold up to 55.12 lbs (25 kg) of frozen food; each plate can hold up to 77.16 lbs (35 kg).



CAUTION

There is a risk of injury from pieces of broken glass. Bottles and cans containing drinks can split or crack when frozen. This applies in particular to carbonated drinks.

► Do not freeze bottles and cans containing drinks.

So that the food is rapidly frozen through to the core, do not exceed the following quantities per pack:

- fruit, vegetables up to 2.2 lb (1 kg)

- meat up to 5.51 lbs (2.5 kg)

► Pack the food in portions in freezer bags, reusable plastic, metal or aluminum containers.

5.7.2 Defrosting food

- at room temperature

- in the microwave

- in the oven/fan oven



WARNING

Danger of food poisoning!

► Do not re-freeze defrosted food.

► Only take out the amount of food that is required. Use defrosted food as quickly as possible.

The temperature can be set between 7 °F (-14 °C) and -16 °F (-26 °C), 0 °F (-18 °C) is recommended.

► To set a higher temperature: press the Freezer compartment Up button *Fig. 2 (5)*.

► To set a lower temperature: press the Freezer compartment Down button *Fig. 2 (4)*.

▷ When the button is pressed for the first time, the previous value is indicated on the freezer compartment temperature display.

► To change the temperature in 1 °F (1 °C) increments: briefly press the button.

-or-

► To change the temperature continuously: hold the button down.

▷ The value is displayed flashing during the setting operation.

▷ The actual temperature is displayed about 5 seconds after the last press of a button. The temperature slowly adjusts to the new value.

5.7.4 SuperFrost

The maximum number of kilograms of fresh food that can be frozen within a 24-hour period is indicated on the rating plate under "Freezing capacity ... kg/24h". This maximum amount of frozen food varies according to the model and climate rating.

Freezing with SuperFrost

You do not need to switch SuperFrost on in the following cases:

- when placing frozen food in the freezer

- when freezing up to about 2 kg of fresh food daily

- ▶ Briefly press the SuperFrost button *Fig. 2 (2)* once.
- ▷ The SuperFrost symbol *Fig. 2 (25)* LED lights up.
- ▷ The freezer temperature drops, the appliance works with maximum refrigerating capacity.
 - When a small amount of food is to be frozen:
 - ▶ Wait for about 6 hours.
 - ▶ Place the fresh food in the top drawers.
 - When the maximum amount of food is to be frozen:
 - ▶ Wait for about 24 hours.
- ▷ SuperFrost is automatically switched off. At the earliest after 30 hours, at the latest after 65 hours, depending on the quantity placed inside the appliance.
- ▷ The SuperFrost button *Fig. 2 (2)* is dark.
- ▷ The SuperFrost symbol *Fig. 2 (25)* LED goes out.
- ▷ The appliance returns to work in the energy-saving normal mode.

5.7.5 Drawers

Note

Insufficient ventilation results in an increase in energy consumption and reduction of the refrigerating performance.

For appliances with NoFrost:

- ▶ Leave the bottom drawer in the appliance.
- ▶ Never block the air slits in the fan on the rear wall.

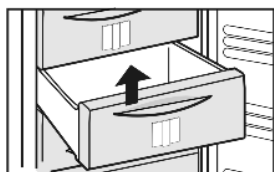

- ▶ To store frozen food directly on the shelves: pull the drawer forward and lift it out.

5.7.6 Shelves

- ▶ To remove shelf: lift it at the front and pull out forward.
- ▶ To reinsert shelf: simply slide it in as far as it will go.

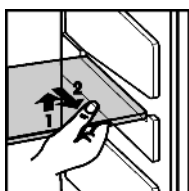

5.7.7 VarioSpace

In addition to the drawers, you can also take out the shelves. This gives you space for large frozen items. Poultry, meat, large joints of game and tall bakery items can be frozen and then presented whole.

- ▶ Each drawer can hold up to 55.12 lbs (25 kg) of frozen food; each plate can hold up to 77.16 lbs (35 kg).

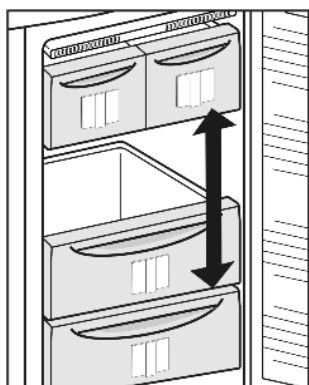

5.7.8 Info system

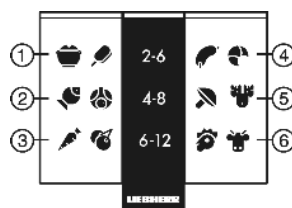

Fig. 3

- | | |
|----------------------------|------------------------|
| (1) Ready meals, ice cream | (4) Sausages, bread |
| (2) Pork, fish | (5) Game, mushrooms |
| (3) Fruit, vegetables | (6) Poultry, beef/veal |

The numbers indicate the storage time in months for different types of frozen foods. The storage times given are guidelines.

5.7.9 IceMaker

The IceMaker is in the top drawer. The drawer is labeled "IceMaker".

Make sure that the following conditions are fulfilled:

- The appliance is level.
- The appliance is connected to the electricity supply.
- The freezer compartment is switched on.
- The minimum freezer temperature is 14 °F (-10 °C).
- The IceMaker is connected to the water supply.
- All air was bled from the waterline before starting the icemaker. The icemaker will only work if there is no air in the waterline.

Switching on the IceMaker

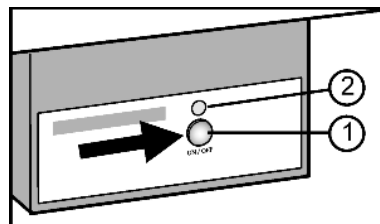

Fig. 4

- ▶ Pull out the drawer.
- ▶ Press On/Off button *Fig. 4 (1)* so that the LED *Fig. 4 (2)* lights up.
- ▶ Push in the drawer.
- ▷ The IceMaker symbol *Fig. 2 (6)* LED lights up.

Note

- ▶ The IceMaker only produces ice cubes when the drawer is completely closed.

Producing ice cubes

The production capacity depends on the freezer temperature. The lower the temperature, the more ice cubes can be produced in a certain period.

The production capacity is 90- 100 ice cubes in 24 hours at a freezing temperature of 0 °F (-18 °C).

To have the maximum capacity of approx. 130 ice cubes in 24 hours, activate the SuperFrost Function. Be aware that this increases the energy consumption because the compressor will run constantly.

Operation

The ice cubes fall out of the IceMaker into the drawer. When the ice cubes reach a certain height in the drawer, no more ice cubes can be produced. The IceMaker will not fill the drawer to the top.

If large quantities of ice cubes are required, the complete IceMaker drawer can be swapped with the neighboring drawer. When you close the drawer, the IceMaker automatically restarts production.

When the IceMaker is switched on for the first time, it may take up to 24 hours for the first ice cubes to be produced.

Note

When the appliance is used for the first time or if has not been used for a long time, the IceMaker has to be rinsed to remove any particles present.

- ▶ To achieve this, do not consume or use the ice cubes that are produced within 72 hours.

Switching off the IceMaker

If ice cubes are not required, the IceMaker can be switched off independently of the freezer compartment.

When the IceMaker is switched off, the drawer of the IceMaker can also be used for freezing and storing food.

- ▶ Press the On/Off button for about 1 second until the LED goes out.
- ▷ The IceMaker symbol *Fig. 2 (6)* LED goes out.
- ▶ Clean the IceMaker.
- ▷ This ensures that no water or ice remains in the IceMaker.

Setting the water supply time

The opening time of the valve on the IceMaker can be adjusted if, for example, the water pressure in the pipe is too low or too high.

The water supply time can be set to levels from E1 (short supply time) to E8 (long supply time).

- ▶ Activate setting mode: press and hold the SuperFrost button *Fig. 2 (2)* for approximately 5 s.
- ▷ 5 is shown on the display.
- ▷ The Menu symbol *Fig. 2 (22)* lights up.
- ▶ Using the Freezer compartment Up button *Fig. 2 (5)* or Freezer compartment Down button *Fig. 2 (4)*, select E.
- ▶ To confirm: briefly press the SuperFrost button *Fig. 2 (2)*.
- ▶ To increase the water supply time: press the Freezer compartment Up button *Fig. 2 (5)*.
- ▶ To decrease the water supply time: press the Freezer compartment Down button *Fig. 2 (4)*.
- ▶ To confirm: press the SuperFrost button *Fig. 2 (2)*.
- ▶ Deactivate setting mode: press the Freezer compartment On/Off button *Fig. 2 (3)*.



-or-

- ▶ Wait 2 min.
- ▷ The temperature is again displayed on the temperature display.

5.8 Wine cooling zone

In the wine cooling zone you can bring your wines to the ideal drinking temperature slowly and evenly.

5.8.1 Storing wine bottles

41 Bordeaux wine bottles (typical 750ml) can be stored in the wine cooling zone.

- ▶ Store white wine in one compartment and red wine in the other compartment as the temperature of the two compartments can be controlled separately.
- ▶ Put the same types of wine next to each other on the same storage shelf as far as possible.
- ▶ Stack the bottles as little as possible.
- ▶ Store opened bottles on the folded down wooden shelf.
- ▶ Folding the wooden shelf down: Push the catch under the panel to one side.
- ▷ The wooden shelf folds down.

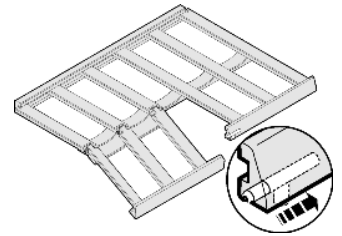

5.8.2 Setting the temperature of the wine cooling zone

The default setting for the appliance is normal mode. The temperature can be set from 68 °F (20 °C) to 41 °F (5 °C), (8 °C) to (12 °C) is recommended.

The wine cooling zone is divided into two wine cooling compartments. The temperature of each of these can be controlled separately.

- ▶ Selecting the wine cooling compartment: Press the Zone button *Fig. 2 (16)*.
- ▷ The selected wine cooling zone is displayed on the temperature display.
- ▶ To set a higher temperature: Press the wine cooling zone UP button *Fig. 2 (14)*.
- ▶ To set a lower temperature: Press the wine cooling zone DOWN button *Fig. 2 (13)*.
- ▷ When the button is pressed for the first time the previous value is displayed on the top wine cooling zone temperature display *Fig. 2 (8)* or on the bottom wine cooling zone temperature display *Fig. 2 (7)*.
- ▶ To change the temperature in 1 °F (1 °C) steps: Press the button briefly.



-or-

- ▶ To change the temperature continuously: Hold the button down.
- ▷ The new value flashes while the settings are being made.
- ▷ The actual temperature is displayed about 5 seconds after the last button is pressed. The temperature slowly adjusts to the new value.

5.8.3 Fan

If the fan is running the relative humidity in the interior increases so that the corks do not dry out.

Energy consumption increases if the fan is switched on. To save energy, the fan automatically switches off when the door is open.

Switching the fan on

- ▶ Press the ventilation *Fig. 2 (18)* button briefly.



- ▷ The Ventilation symbol LED lights up.
- ▷ The fan continues to run. The humidity is high.

Switching the fan off

- ▶ Press the ventilation *Fig. 2 (18)* button briefly.
- ▷ The Ventilation symbol LED is dark.
- ▷ The fan only works when this is necessary to control the temperature. The humidity is low.

5.8.4 Dim mode

With models with glass doors you can set dim mode for the light, i.e. the intensity of the light after the door has been closed.

Setting dim mode

Note

- ▶ If the dim mode is disabled the light slowly gets darker and then goes out after the door has been closed.

- ▶ Press the light *Fig. 2 (17)* button briefly.
- ▷ The light button *Fig. 2 (17)* comes on. The dim mode is selected.

The settings apply to all wine cooling compartments.

- ▶ Setting the light brighter: Press the light button *Fig. 2 (17)* and the wine cooling zone UP button *Fig. 2 (14)* at the same time.
- ▶ Setting the light darker: Press the light button *Fig. 2 (17)* and the wine cooling zone DOWN button *Fig. 2 (13)* at the same time.

5.8.5 Description labels

You can write which wines are stored in the respective compartments on the labels. You can obtain additional description labels from your dealer.

Writing on the labels

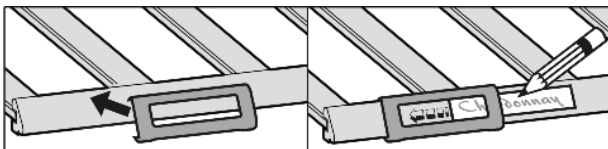

5.8.6 Wooden shelf

Note

- ▶ Do not load the wooden shelf with more than 26.46 lbs (12 kg).

Ensure that the wooden shelf does not remain suspended on the rear hook.

- ▶ To remove the folding wooden shelf: lift upwards out of the pull out rail and pull it forwards.

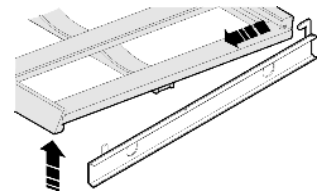

- ▶ To fit the folding wooden shelf: push it under the rear hook and press onto the rails until it clicks into place.

- ▶ To remove the lower wooden shelf: pull forward at an angle and lift up at the same time.

- ▶ To fit the lower wooden shelf: insert over the stop fitted to the undershelf until it hits the back wall of the appliance and press down.

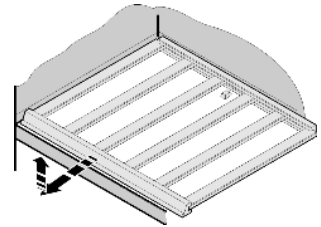

- ▶ To insert other wooden shelves: attach to the rails.

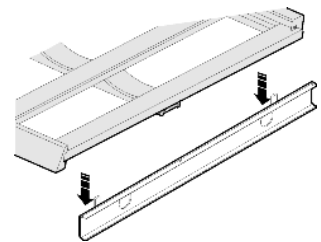

6 Maintenance

6.1 Replacing the active carbon filter

The active carbon filter guarantees optimum air quality and should therefore be replaced once a year. It can be ordered from a dealer.

Each wine cooling compartment is fitted with an active carbon filter.

- ▶ Grasp the filter by the handle.
- ▶ Turn it 90° to the right or left *Fig. 5 (1)*.
- ▶ Remove the filter .
- ▶ Insert the new filter with the handle in a vertical position.
- ▶ Turn it 90° to the right or left *Fig. 5 (1)* until it clicks into place.

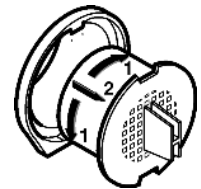

Fig. 5

6.2 Replacing the water filter

The water filter should be changed when the Filter symbol *Fig. 2 (10)* lights up. It should be replaced every six months at least or whenever you notice a significant decrease in the flow rate You can order one from your dealer or by visiting our web site at www.liebherr-appliances.com.

The used water filter contains activated carbon and can be disposed of with normal household waste.

Maintenance

To remove the old water filter:

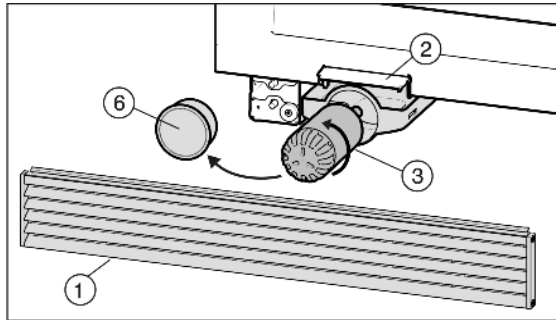

Fig. 6

- ▶ lift the ventilation grid Fig. 6 (1) up and pull out.
- ▶ Open the filter change flap Fig. 6 (2).
- ▶ Pull the water filter carriage Fig. 6 (3) out.
- ▶ Remove the filter cover Fig. 6 (6).
- ▶ Catch any dripping water with your hand or with a dish.
- ▶ Turn the water filter Fig. 6 (3) about 100° anti-clockwise and pull out.

Note

If no new water filter is inserted:

- ▶ put the filter cover on to protect the filter unit from dirt and dust.

To install a new water filter:

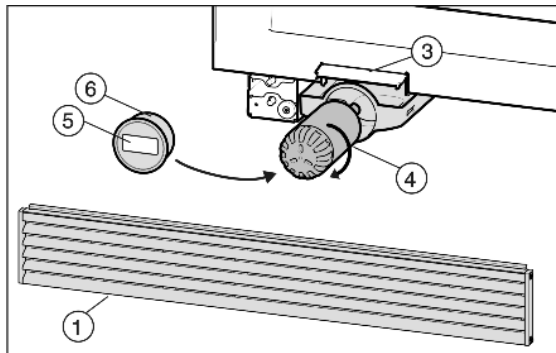

Fig. 7

- ▶ Insert the new filter Fig. 7 (4) and turn it about 100° clockwise as far as it will go.
- ▶ Place the cover Fig. 7 (6) on the filter.
- ▶ Write the date of the next filter replacement on the supplied adhesive label Fig. 7 (5) and affix it to the filter cover Fig. 7 (6).
- ▶ Push in the water filter carriage Fig. 7 (4).
- ▶ Close the filter change flap Fig. 7 (3).
- ▶ Fit the ventilation grid Fig. 7 (1) again and push down. It must close flush with the floor.

Note

New water filters may contain suspended particles and must be rinsed through before use.

- ▶ To achieve this, do not consume or use the ice cubes that are produced within 72 hours of the filter being replaced.
- ▶ Remove any ice in the IceMaker drawer. The ice can be stored in another drawer as a reserve supply.

- ▶ Make sure the filter does not leak and no water is coming out.

To reset the timer:

- ▶ Select setting mode: Press and hold the SuperFrost button Fig. 2 (2) for approx. 5 seconds.
 - ▷ The SuperFrost button will flash
 - ▷ 5 will appear on the display.
- ▶ Using the freezer compartment Up button Fig. 2 (5) or freezer compartment Down button Fig. 2 (4), select F.
- ▶ To confirm: Briefly press the SuperFrost Fig. 2 (2) button.
 - ▷ F8 will appear on the display.
- ▶ To confirm: Briefly press the SuperFrost Fig. 2 (2) button.
 - ▷ The filter symbol Fig. 2 (10) goes out

6.3 Defrosting with NoFrost

The NoFrost system defrosts the appliance automatically.

Wine cooling zone:

The defrosted water is evaporated by the heat of the compressor. Drops of water on the back wall are a functional feature and completely normal.

- ▶ Clean the drain opening regularly so that the defrosted water can flow away (see 6.4) .
- ▶ Clean rubber lip (see 6.4) .

Freezer compartment:

The moisture condenses on the evaporator and is periodically defrosted and evaporated.

- ▶ The appliance does not need to be defrosted manually.

6.4 Cleaning the appliance

Before cleaning:



WARNING

Danger of electric shock.

- ▶ First, remove the plug or switch off the fuse.



CAUTION

Risk of injury or damage due to hot steam.

Hot steam can damage the surfaces and cause burns.

- ▶ Do not use steam cleaners.

NOTICE

Incorrect cleaning damages the appliance.

- ▶ Do not use concentrated cleaning agents.
- ▶ Do not use steel wool or sponges that scour or scratch.
- ▶ Do not use cleaning agents containing sand, chloride, chemicals or acids.
- ▶ Do not use chemical solvents.
- ▶ Do not damage or remove the rating plate on the inside of the appliance. It is vital for the customer service department.
- ▶ Do not pull off, kink or damage any cables or other components.
- ▶ Do not let cleaning water get into the drain gutter, the ventilation grille and electrical parts.

- ▶ Empty the appliance.
- Use soft cleaning cloths and a multi-purpose cleaning agent with a neutral pH value.
- Only use food-compatible cleaning and care agents inside the appliance.
- ▶ Clean the ventilation grills regularly.
- ▷ Dust deposits increase energy consumption.



Do not clean the glass door with abrasive cleaning agents or rough cloths. Otherwise the surface and the frame may become dull or be scratched.

- ▶ Clean the glass door with a standard glass cleaner and a soft cloth.
- ▶ Clean the plastic surfaces inside and out by hand using lukewarm water and a little dishwashing liquid.
- ▶ If dirty clean stainless steel external surfaces with a commercially available stainless steel cleaning agent. Then apply the supplied stainless steel cleaning agent evenly in the direction of the grain.*

Do not apply stainless steel cleaning agents to glass or plastic surfaces so as not to scratch them. Initially darker areas and quite an intensive color of the stainless steel surfaces are normal.*

Stainless steel which is exposed to chlorine gas or dampness may become discolored. This is normal. If your appliance is exposed to chlorine gas or dampness, clean and polish it more frequently. If there are any signs of rust or discoloration, clean and polish the appliance as soon as possible.*

Accessories:

- ▶ Clean accessories by hand using lukewarm water and a little dishwashing liquid.

After cleaning:

- ▶ Wipe the appliance and accessories dry.
- ▶ Connect the appliance and switch it on again.
- ▶ Switch on SuperFrost (see 5.7.4) .
- When the temperature is sufficiently cold:
- ▶ put the food back in the appliance.

6.5 Cleaning the IceMaker

The IceMaker drawer must be emptied and pushed in.

- ▶ Activate setting mode: press and hold the SuperFrost button *Fig. 2 (2)* for approximately 5 s.
- ▷ 5 is shown on the display.
- ▷ The Menu symbol *Fig. 2 (22)* lights up.
- ▶ Using the Freezer compartment Up button *Fig. 2 (5)* / Freezer compartment Down button *Fig. 2 (4)*, select 1.
- ▶ To confirm: press the SuperFrost button *Fig. 2 (2)*.
- ▶ Using the Freezer compartment Up button *Fig. 2 (5)* / Freezer compartment Down button *Fig. 2 (4)*, select 1c.
- ▶ To confirm: press the SuperFrost button *Fig. 2 (2)*.
- ▷ The IceMaker moves into cleaning position and shuts off.
- ▶ Deactivate setting mode: press the Freezer compartment On/Off button *Fig. 2 (3)*.



-or-

- ▶ Wait 2 min.

- ▷ The temperature is again displayed on the temperature display.
- ▶ Take out the drawer.
- ▶ Clean the ice compartment and drawer with warm water. If necessary, use a mild dishwashing liquid. Then rinse.
- ▶ Slide the drawer back in.
- If dishwashing liquid was used:
- ▶ Throw out the first three batches of ice cubes to get rid of any dishwashing liquid residues.

Either leave the IceMaker switched off in this position or switch the IceMaker back on (see 5.7.9) .

6.6 Customer service

First check whether you can remedy the fault yourself (see Troubleshooting). If this is not the case, please contact the Customer Service department. You can find the address in the enclosed customer service list.



WARNING

Risk of injury from repairs by non-professionals.

- ▶ Repairs and work on the appliance and the power cord, which are not expressly named (see Maintenance) should only be carried out by the customer service department.

- ▶ Read the appliance designation *Fig. 8 (1)*, service no. *Fig. 8 (2)* and serial no. *Fig. 8 (3)* from the rating plate. The rating plate is located inside the appliance on the left-hand side.

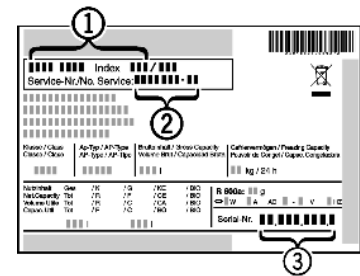

Fig. 8

- ▶ Notify the Customer Service department, specifying the fault, appliance designation *Fig. 8 (1)*, service no. *Fig. 8 (2)* and serial *Fig. 8 (3)* no.
- ▷ This will help us to provide you with a faster and more accurate service.
- ▶ Keep the appliance closed until the Customer Service engineer arrives.
- ▷ The food will stay cool longer.
- ▶ Disconnect the power plug (do not pull on the power cord to do this) or switch off the fuse.

6.7 Appliance Information

Make a note of this information when the appliance is installed:

- Type Designation: _____
- Service Number: _____
- Appliance / Serial Number: _____
- Date of purchase: _____
- Where purchased: _____

Troubleshooting

7 Troubleshooting



Your appliance is designed and manufactured for reliable operation and a long lifespan. If a malfunction nonetheless occurs during operation, please determine if the

malfunction is due to an operating error. If a service call determines operator error, you will be charged for the costs incurred, even during the warranty period. You may be able to rectify the following problems yourself:

Problem	Possible Cause	Correction
The appliance does not work.	The appliance is not switched on.	▶ Switch on the appliance.
	The power plug is not properly inserted in the wall socket.	▶ Check the power plug.
	The fuse in the wall socket is not OK.	▶ Check the fuse.
	Power failure	▶ Keep the appliance closed. ▶ Protect the food: place dry ice on top of the food or use a use an alternate freezer, if the power failure persists for some time. ▶ Do not re-freeze defrosted food.
The compressor runs for a long time.	When less refrigeration is required, the speed-controlled compressor switches to a low speed. Although the running time is increased as a result, energy is saved.	▶ This is normal in energy-saving models.
	SuperFrost function is activated.	▶ The compressor runs long to rapidly freeze food. This is normal.
Noises are too loud.	The different speed levels of speed-controlled* compressors can cause them to generate various noises during operation.	▶ These noises are normal.
A gurgling sound	This sound comes from the refrigerant flowing in the refrigeration circuit.	▶ The sound is normal.
A faint clicking sound	The sound always occurs when the refrigeration unit (the motor) automatically switches on or off.	▶ The sound is normal.
A hum. It is briefly a little louder when the refrigeration unit (the motor) switches on.	The refrigeration increases automatically when the SuperFrost function is activated, fresh food has just been placed in the appliance or the door has been left open for a while.	▶ The sound is normal.
	The ambient temperature is too high.	▶ Solution: (see 1.3)
A low hum	The sound occurs as a result of fan air flow.	▶ The sound is normal.
Vibration noise	The appliance is not standing firmly on the floor. As a result, adjoining units or objects are set into vibration by the running refrigeration unit.	▶ Move bottles and containers apart.
Flow noise on the soft stop mechanism.	The sound is caused by the soft stop mechanism.	▶ The sound is normal.
	As encountered with other forms of storage, a little mold may form	▶ Remove adhesive residues.

Problem	Possible Cause	Correction
Mold on the wine bottles	depending on the type of label adhesive.	
The temperature display indicates: F8 to F9.	There is a fault.	▶ Contact the customer service department. (see Maintenance).
The temperature display reads: FE	There is a fault.	▶ Contact the customer service department. (see Maintenance).
The temperature display indicates power failure . The warmest temperature reached during the power failure is displayed in the temperature display.	The freezer temperature rose too high during the last hours or days due to power failure or power interruption. When the power interruption is over, the appliance will continue to operate at the last temperature setting.	▶ To delete the display of the warmest temperature: Press the Alarm button <i>Fig. 2 (1)</i> . ▶ Check the quality of the food. Do not consume spoiled food. Do not re-freeze defrosted food.
DEMO lights up in the temperature display.	The demo mode is activated.	▶ Contact the customer service department. (see Maintenance).
The Filter Symbol <i>Fig. 2 (10)</i> lights up.	The water filter should be replaced.	▶ Replace the water filter. (see Maintenance).
The outside surfaces of the appliance are warm.	The heat of the refrigerant circuit is used to prevent condensate from forming.	▶ This is normal.
The IceMaker cannot be switched on.	The appliance and therefore the IceMaker are not connected.	▶ Connect the appliance (see Start-up).
The IceMaker is not making ice cubes.	The IceMaker is not switched on.	▶ Switch the IceMaker on.
	The drawer of the IceMaker is not properly closed.	▶ Close the drawer properly.
	The water connection is not open.	▶ Open the water connection.
	The waterline was not bled of all air during installation	▶ Please contact your qualified installation plumber to ensure the above criteria is met before calling for service.
The temperature is not cold enough.	The door of the appliance is not closed properly.	▶ Close the appliance door.
	Insufficient ventilation.	▶ Clear ventilation grilles.
	The ambient temperature is too high.	▶ Solution: (see 1.3)

Putting appliance out of service

Problem	Possible Cause	Correction
	The appliance was opened too frequently or for too long.	► Wait to see whether the required temperature resets itself by itself. If not, contact the customer service department. (see Maintenance).
	Too much fresh food was placed inside without SuperFrost.	► Solution: (see 5.7.4)
	The temperature is incorrectly set.	► Set to a colder temperature and check after 24 hours.
	The appliance is too near to a heat source.	► Solution: (see Start-up).
Display show two dashes ("- -").	The freezer temperature display will only show temperatures that are below freezing.	► When initially starting the appliance it will not be below freezing. It will take three to five hours (depending on ambient conditions) for freezing temperatures to be achieved and thus displayed numerically.
	The freezer temperature has risen above zero degrees due to a power failure or power interruption.	► See also "Power failure" and 
The interior light is not on.	The appliance is not switched on.	► Switch on the appliance.
	The door was open for longer than 15 minutes.	► The interior light automatically switches itself off if the door has been open for about 15 minutes.
	The LED light is faulty or the cover is damaged:	<div style="border: 1px solid red; padding: 5px;">  WARNING Risk of injury from electrical shock. Live parts are under the cover. ► The LED interior light should only be replaced or repaired by the Customer Service department or by engineers trained to do so. </div> <div style="border: 1px solid red; padding: 5px; margin-top: 10px;">  WARNING Risk of injury from class 1M laser radiation. ► Do not look inside when the cover is open. </div>

8 Putting appliance out of service

8.1 Vacation Tips

Short vacations: If you will be away for less than four weeks

- Turn off the icemaker.
- Shut down the water supply to the icemaker.

Long vacations: If you will be away for a month or more

- Remove all food from the appliance.
- Turn OFF the appliance.
- Clean the appliance (see 6.4).
- Leave the door open to prevent unpleasant odors.
- ▷ This will also keep mold from building up.
- Turn off the icemaker.
- Shut off the water supply to the icemaker.

8.2 Switching off the appliance

Note

- To switch off the entire appliance, only the freezer compartment needs to be switched off.

8.2.1 Switching off the freezer compartment

- Press Freezer compartment On/Off button *Fig. 2 (3)* for about 2 seconds.
- ▷ The temperature displays are dark. The appliance is switched off.

8.2.2 Switching off the wine cooling zone

- Press Wine cooling zone On/Off button *Fig. 2 (15)* for about 2 seconds.

- ▷ The temperature display of the top wine cooling zone *Fig. 2 (8)* and the temperature display of the bottom cooling zone *Fig. 2 (7)* are dark. The wine cooling zone is switched off.

8.3 Decommissioning

- ▶ Empty the appliance.
- ▶ Put the IceMaker in the cleaning position (see Maintenance).
- ▶ Disconnect the power plug.
- ▶ Clean the appliance (see 6.4).



- ▶ Leave the door open to prevent bad smells.

9 Disposing of the appliance

Follow the local regulations for the disposal of appliances. Old appliances can be dangerous. Contact the local refuse collection department for additional information.



DANGER

There is a risk of suffocation.

Children playing can shut themselves in and suffocate.

- ▶ Take the door(s) off.
- ▶ Remove the drawers.
- ▶ Leave the storage shelves in the appliance so that children cannot easily climb into the appliance.



WARNING

Danger of electric shock.

- ▶ Cut off the plug from the power cord and discard.
- ▶ Cut off the power cord from the discarded appliance. Dispose of separately from the appliance.

All service provided by Liebherr under the warranty must be performed by authorized Liebherr service representatives, unless otherwise specified by Liebherr. Service will be provided in the home during normal business hours. This warranty applies only to products installed for normal residential use. Details regarding a non-residential warranty are available on request.

The warranty applies only to products installed in any one of the fifty states of the United States or the District of Columbia. The warranty does not cover any parts or labor to correct any defect caused by negligence, accident or improper use, maintenance, installation, service or repair, including but not limited to improper removal and reinstallation of the condensing unit.

The remedies described above for each warranty are the only ones which Liebherr will provide, either under these warranties or under any warranty arising by operation of law. Liebherr will not be responsible for any consequential or incidental damages arising from the breach of these warranties or any other warranties, whether express, implied or statutory.

Some states do not allow the exclusion or limitation of incidental or consequential damages so the above limitation or exclusion may not apply to you. This warranty gives you specific legal rights and you may also have other legal rights which vary from state to state.

To receive parts and/or service and the name of the Liebherr authorized service representative nearest you, contact your Liebherr dealer or distributor or contact the Liebherr designated national service provider:

in the US: Liebherr@adcoservice.com or call 1- 866 - LIEBHERR (1- 866 - 543-2437).

in Canada: www.euro-parts.ca or call 1-888-LIEBHERR (1-888-543-2437).

10 Liebherr Warranty Plan

FULL TWO YEAR WARRANTY - For two years from the date of original purchase, your Liebherr warranty covers all parts and labor to repair or replace any part of the product which proves to be defective in materials or workmanship.

FULL FIVE YEAR WARRANTY - For five years from the date of original purchase, your Liebherr warranty covers all parts and labor to repair or replace any components that prove to be defective in materials or workmanship in the sealed system. The "Sealed System" means only the compressor, condenser, evaporator, drier and all connecting tubing.

LIMITED 6TH THROUGH 12TH YEAR WARRANTY - From the 6th through 12th year from the date of original purchase, your Liebherr warranty covers all parts that prove to be defective in materials or workmanship in the Sealed System (parts only).

TERMS APPLICABLE TO EACH WARRANTY

