

LIEBHERR

Use and Care Manual

Under-worktop large capacity
BioFresh refrigerator

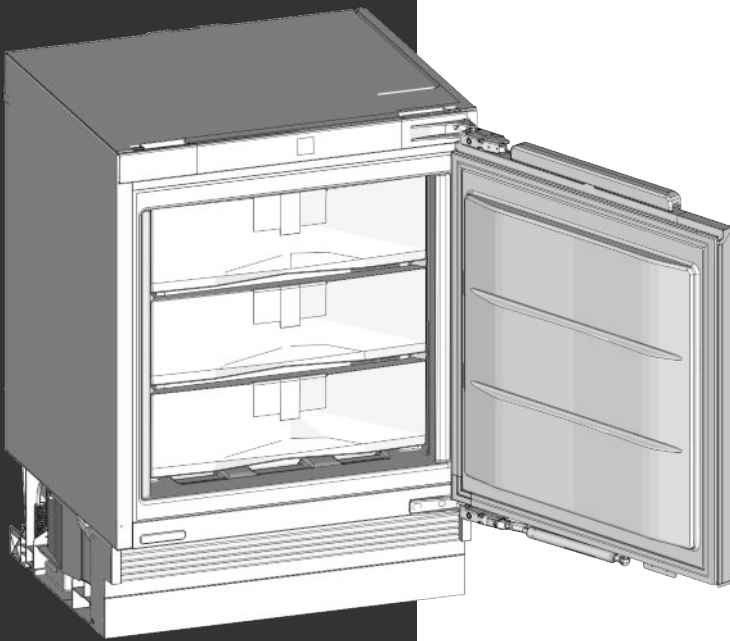

UB 501

20191111 7086662 - 01

The appliance at a glance

Contents

1	The appliance at a glance.....	2
1.1	Additional benefits.....	2
1.2	Overview of the appliance and accessories.....	3
1.3	Range of appliance use.....	3
1.4	Conformity.....	3
1.5	Product information.....	3
1.6	Energy saving.....	3
2	General safety information.....	4
3	Controls and displays.....	5
3.1	Operating and control elements.....	5
3.2	Temperature display.....	5
4	Start-up.....	5
4.1	Switching on the appliance.....	5
5	Operation.....	6
5.1	Temperature display unit.....	6
5.2	Child-proof lock.....	6
5.3	Door alarm.....	6
5.4	Sabbath Mode.....	6
5.5	Storing food.....	7
5.6	Storage times.....	7
5.7	Setting the temperature.....	8
5.8	Adjusting humidity.....	8
5.9	Drawers.....	8
5.10	Info system.....	9
5.11	Using the FlexSystem.....	9
5.12	Shelves.....	9
5.13	VarioSpace.....	9
6	Maintenance.....	9
6.1	Defrosting with NoFrost.....	9
6.2	Cleaning the appliance.....	10
6.3	Customer service.....	10
6.4	Appliance Information.....	10
7	Troubleshooting.....	10
8	Putting appliance out of service.....	13
8.1	Vacation Tips.....	13
8.2	Switch off device.....	13
8.3	Decommissioning.....	13
9	Disposing of the appliance.....	13

Congratulations on the purchase of your new appliance. With this purchase, you have chosen all the advantages of the latest refrigeration technology, guaranteeing you a high-quality appliance with a long life span and high operating safety.

The equipment of your appliance gives you the highest level of day-to-day ease of operation.

Together we are making an active contribution to the conservation of our environment by purchasing this appliance which is manufactured in an environmentally friendly process with the use of recyclable materials.

We hope you enjoy your new appliance.

The manufacturer is constantly working to improve all models. Therefore please understand that we reserve the

right to make design, equipment and technical modifications.

To get to know all the benefits of your new appliance, please read the information contained in these instructions carefully.

The instructions apply to several models, so there may be differences. Sections which only apply to certain appliances are indicated with an asterisk (*).

Instructions for action are marked with a ►, the results of action are marked with a ▷.

1 The appliance at a glance

1.1 Additional benefits

- CFC free
- Energy-optimized refrigerant circuit
- Energy-efficient insulation
- Low energy consumption
- User-friendly electronic controls
- Active function indicators
- Temperature can be controlled in the appliance independent of ambient conditions according to its climate rating - Temperature can be displayed as °C or °F
- The appliance defrosts automatically - no need to spend time defrosting
- Safety glass storage shelves
- Shelves can be removed to make space for large items.
- Bright LED interior light
- Door ajar alarm
- Handle grips on all extra-large drawers for easy transport
- Integrated transport grips on appliance housing
- Easy to clean
- Door hinges can be reversed
- Door-on-door system for easy kitchen cabinet installation
- Soft stop mechanisms
- This appliance has a Sabbath Mode function, which makes it possible to use the appliance on religious holidays. Further information can be found on the Star-K website www.star-k.org.

1.2 Overview of the appliance and accessories

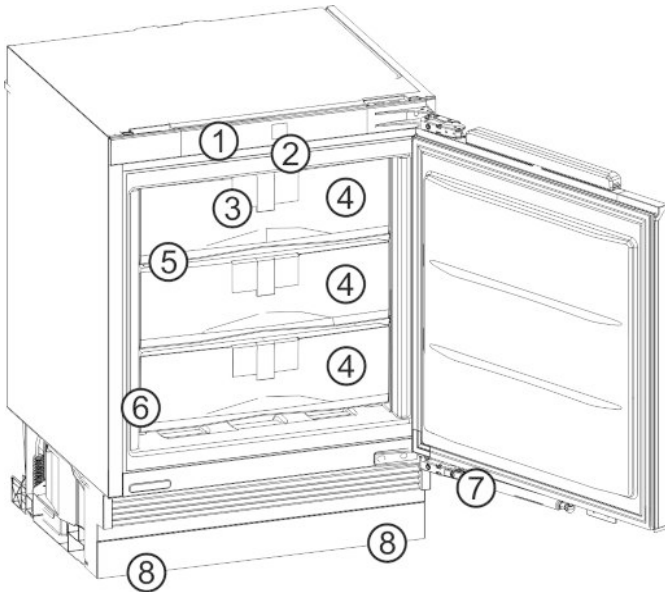

Fig. 1

- | | |
|------------------------------------|-------------------------|
| (1) Operating and control elements | (5) VarioSpace elements |
| (2) Lighting | (6) Rating plate |
| (3) Info system | (7) Closing damper |
| (4) Drawers | (8) Adjustable feet |

Note

- Shelves, drawers, and baskets are arranged for optimal energy efficiency in the factory configuration.

1.3 Range of appliance use

Normal use

The appliance is only suitable for cooling food for residential or other similar environments. This includes the following types of uses

- in staff kitchens, bed and breakfasts,
- by guests in country homes, hotels, motels and other types of accommodations,
- for catering and similar wholesale services.

The appliance is suitable for integrated under worktop use

All other types of uses are not permitted.

Foreseeable misuse

The following uses are specifically prohibited:

- Storage and cooling of medication, blood plasma, laboratory preparations or similar substances and products in accordance with the CMDCAS and FDA 510(k)
- Use outdoors.

- Use in moist areas exposed to the rain.
- Use in areas at risk of explosion

Incorrect appliance use can cause damage to the stored products or cause them to spoil.

Climate ratings

The appliance is set to operate within specific ambient temperature limits according to its climate rating. The climate rating for your appliance is printed on the rating plate.

Note

- To guarantee trouble-free operation, comply with the indicated ambient temperatures.

Climate rating	for ambient temperatures from
SN	50 °F (10 °C) to 90 °F (32 °C)
N	61 °F (16 °C) to 90 °F (32 °C)
ST	61 °F (16 °C) to 101 °F (38 °C)
T	61 °F (16 °C) to 110 °F (43 °C)

1.4 Conformity

The refrigerant circuit has been tested for leaks. When installed, the appliance complies with the relevant safety regulations and the safety standards CAN/CSA-C22.2 No. 60335-1-11, 60335-2-24-06 and UL 60335-1, UL 60335-2-24.

BioFresh meets EN ISO 8561 requirements for a chill compartment.

1.5 Product information

Product information is enclosed with the device in accordance with (EU) Ordinance 2017/1369. The complete product information sheet is available on the Liebherr website in the download area.

1.6 Energy saving

- Always ensure good ventilation. Do not obstruct ventilation openings or grilles.
- Never block air slits in the fan.
- Do not install the appliance in direct sunlight or next to an oven, heater, or similar heat source.
- Energy consumption depends on installation conditions such as the ambient temperature (see 1.3). If the ambient temperature differs from the standard temperature of 25 °C, energy consumption can change.
- Avoid opening the appliance door for any longer than necessary.
- The lower the temperature is set the higher the energy consumption.
- All food stored in the appliance should be well wrapped and covered. This prevents frost buildup.

General safety information

- Only take food out for as long as necessary so that it does not get too warm.
- Insertion of warm foods: first let the food cool down to room temperature.

2 General safety information

Read and follow these instructions. They contain safety advice which is important for safe and problem-free installation and operation. Always read and follow the safety advice.

Dangers for the user:

- This appliance can be operated by children as well as by persons with reduced physical, sensory or mental capabilities or lack of experience and knowledge if they are supervised or have been instructed in the safe use of the appliance and understand the associated risks. Children must not play with the appliance. Cleaning and user maintenance must not be performed by children unless they are supervised. Children between the ages of 3 and 8 may load and unload the appliance. Children under the age of 3 must be kept away from the appliance if they are not constantly supervised.
- When disconnecting the appliance from the outlet, always take hold of the plug. Do not pull on the cable.
- Disconnect the power plug or switch off the power if a fault occurs.
- Do not damage the mains power line. Do not operate the appliance from a defective mains power line.
- Repairs, work on the appliance and replacement of the mains cable should only be carried out by the customer service department or other specifically trained specialist engineers.
- Only install, connect and dispose of the appliance in accordance with the instructions.
- Only operate the appliance after it has been installed.
- Please keep the instructions and pass them on to any future owner.
- Special-purpose lamps inside the appliance are intended to illuminate its interior compartments and are unsuitable for room illumination.

Risk of fire:

- The refrigerant contained within the appliance (specifications on the rating plate) is environ-

mentally friendly, but flammable. Leaking refrigerant can ignite.

- Do not damage the pipes of the refrigerant circuit.
- Do not handle naked flames or ignition sources inside the appliance.
- Do not use electrical devices inside the appliance (e.g. steam cleaners, heaters, ice cream makers, etc.).
- If refrigerant leaks: Remove naked flames or ignition sources located near the area of the leak. Air the room well. Contact the customer service department.
- Do not operate the appliance near explosive gases.
- Do not store or use gasoline or other flammable vapors and liquids in the vicinity of this appliance.
- Do not store explosive materials or spray cans with flammable propellants, such as e.g. butane, propane, pentane, etc. in the appliance. You can recognize such spray cans by the printed contents or a flame symbol. Any leaking gasses can be ignited by electrical components.
- Alcoholic beverages or other containers holding alcohol must always be tightly sealed for storage purposes. Any leaking alcohol can be ignited by electrical components

Tipover hazard:

- Do not stand or climb on the base, drawers, doors, etc. This applies in particular to children.

Risk of food poisoning:

- Do not consume food that has passed its best before date.

Danger of frostbite, feelings of numbness and pain:

- Avoid continued skin contact with the cold surfaces or chilled/frozen food or adopt protective measures, e. g. use gloves. Do not consume ice cream (especially sherbets) and ice cubes immediately when they are too cold.

Risk of injury and damage:

- Hot steam may lead to injuries. Do not use any electrical heating or steam cleaning equipment, naked flames or defrosting sprays for defrosting
- Do not remove ice with sharp objects



Risk of crushing:

- Do not hold onto the hinge when opening and closing the door. Fingers may get caught.



California Proposition 65

- This product contains chemicals known to the state of California to cause cancer or reproductive harm.
- This product can expose you to chemicals including Diisononyl Phthalate (DINP) which is known to the State of California to cause cancer. For more information go to www.P65Warnings.ca.gov.
- This product can expose you to chemicals including Di-isodecyl Phthalate (DIDP) which is known to the State of California to cause birth defects or other reproductive harm. For more information go to www.P65Warnings.ca.gov.

Symbols on the device:

	The symbol can be on the compressor. It refers to the oil in the compressor and refers to the following danger: Can be lethal if swallowed or inhaled. This notice only applies for recycling. There is no danger during normal operation.
	The symbol is located on the compressor and indicates the danger of inflammable materials.
	This label or a similar one can be located on the rear of the appliance. It refers to the foamed-in panels in the door and/or the housing. This notice only applies for recycling. Do not remove the label.

Follow the specific instructions in the other sections:

	DANGER	indicates a hazardous situation, which if not avoided, will result in death or serious injury.
	WARNING	indicates a hazardous situation, which if not avoided, could result in death or serious injury.
	CAUTION	indicates a hazardous situation, which if not avoided, will result in minor or moderate injury.
	NOTICE	indicates a hazardous situation, which if not avoided, could result in damage to property.

Note	indicates useful advice and tips.
------	-----------------------------------

3 Controls and displays

3.1 Operating and control elements

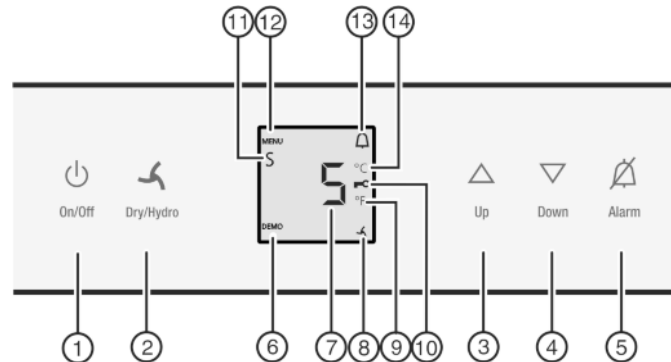

Fig. 2

- | | |
|-------------------------|--------------------------|
| (1) On/Off button | (8) Dry/Hydro symbol |
| (2) Dry/Hydro button | (9) Fahrenheit display |
| (3) Up button | (10) Child safety symbol |
| (4) Down button | (11) Sabbath mode symbol |
| (5) Alarm button | (12) MENU symbol |
| (6) DEMO symbol | (13) Alarm symbol |
| (7) Temperature display | (14) Celsius display |

3.2 Temperature display

The following is displayed in normal operation:

- the set BioFresh temperature

The temperature display flashes:

- the temperature setting has been changed

The following displays indicate malfunction. Possible causes and corrective actions: (see 7) .

- **F0** to **F9**

4 Start-up

4.1 Switching on the appliance

- ▶ Open the door.
- ▶ Press On/Off button *Fig. 2 (1)*.
- ▷ The temperature display displays the temperature setting.
- ▷ The interior light comes on when the door is opened.
- ▷ Whenever "DEMO" appears on the display, the appliance is running in demonstration mode. Contact the customer service department.

Operation

5 Operation

5.1 Temperature display unit

The temperature display can be changed from °F to °C.

5.1.1 To change the unit

- ▶ To activate setting mode: Press and hold the Dry/Hydro button *Fig. 2 (2)* for approx. 5 s.
 - ▷ The Menu symbol *Fig. 2 (12)* lights up.
 - ▷ 5 is displayed in the temperature display.
 - ▶ Using Up button *Fig. 2 (3)*/ Down button *Fig. 2 (4)* select °.
 - ▶ To confirm: Briefly press the Dry/Hydro button *Fig. 2 (2)*.
 - ▷ The temperature unit is displayed.
 - ▶ To confirm: Briefly press the Dry/Hydro button *Fig. 2 (2)*.
 - ▷ ° flashes.
 - ▶ To exit setting mode: Press On/Off button *Fig. 2 (1)*.
- or-**
- ▶ Wait 5 minutes.
 - ▷ The temperature is again displayed in the temperature display.



5.2 Child-proof lock

You can use the child-proof lock to lock the buttons. This means that children cannot accidentally switch off the appliance when playing.



5.2.1 Switching on the child-proof lock

- ▶ To activate setting mode: Press and hold the Dry/Hydro button *Fig. 2 (2)* for approx. 6 s.
 - ▷ 5 is shown on the display.
 - ▷ The Menu symbol *Fig. 2 (12)* lights up.
 - ▶ Press the Dry/Hydro button *Fig. 2 (2)* briefly to confirm.
 - When cI is shown on the display:
 - ▶ To switch on the child-proof lock, press the Dry/Hydro button *Fig. 2 (2)* briefly.
-
- ▷ The Child safety symbol *Fig. 2 (10)* lights up. c flashes on the display.
 - When c0 is shown on the display:
 - ▶ To switch off the child-proof lock, press the Dry/Hydro button *Fig. 2 (2)* briefly.
 - ▷ The Child Safety symbol *Fig. 2 (10)* goes out. c flashes on the display.
 - ▶ To cancel setting mode: Press the On/Off button *Fig. 2 (1)*.
- or-**
- ▶ Wait 5 mins.
 - ▷ The temperature is again displayed on the temperature display.

5.3 Door alarm

If the door is open for longer than 180 seconds, the acoustic warning sounds.

The acoustic warning stops automatically when the door is closed



5.3.1 Switching off the door alarm

The acoustic warning can be switched off when the door is open. The acoustic warning remains switched off as long as the door is open. When the door is closed, the alarm function is active again.

- ▶ Press Alarm button *Fig. 2 (5)*.
- ▷ The door alarm stops.

5.4 Sabbath Mode

This function meets the religious requirements on the Sabbath and Jewish festivals. When the appliance is in Sabbath mode some control electronic functions are switched off. After setting Sabbath mode you no longer need to worry about indicator lights, figures, symbols, displays, alarm messages and fans. The thawing cycle only operates at the specified time without taking refrigerator use into account. After a power cut the appliance automatically switches on again in Sabbath mode.

You can find a list of Star-K-certified appliances at www.star-k.org/appliances.



WARNING

Danger of food poisoning!

No record will be kept of a power failure during Sabbath Mode. Thus, during Sabbath mode, if a power failure occurs that you are not aware of, when the power comes back on, the unit will continue to be in Sabbath Mode but when Sabbath Mode is ended there will be no indication that a power failure occurred.

If a power failure occurs during Sabbath mode:

- ▶ Check the quality of the food. Do not consume spoiled food!

- All functions are blocked until Sabbath mode is switched off.
- If the unit is currently running in a mode such as Superfrost, Supercool or the Ventilation is enabled these functions will continue and finish their timed cycles independent of now being in Sabbath mode.
- No audible signals are emitted, and the temperature display does not indicate any warnings or settings (such as a temperature alarm or door alarm).
- Light does not operate.

5.4.1 Setting Sabbath mode

- ▶ To activate setting mode: Press and hold the Dry/Hydro button *Fig. 2 (2)* for approx. 5 s.
- ▷ 5 flashes on the display.
- ▷ The Menu symbol *Fig. 2 (12)* lights up.

- ▶ To access the Sabbath mode function: Briefly press the Dry/Hydro button *Fig. 2 (2)*.

When **51** is shown on the display:

51

- ▶ **To turn on** Sabbath mode, briefly press the Dry/Hydro button *Fig. 2 (2)*.

When **50** is shown on the display:

50

- ▶ **To turn off** Sabbath mode, briefly press the Dry/Hydro button *Fig. 2 (2)*.
- ▶ To deactivate setting mode: Press the On/Off button *Fig. 2 (1)*.

-or-

- ▶ Wait 5 min.

- ▷ The Sabbath Mode symbol *Fig. 2 (11)* appears on the temperature display as long as Sabbath Mode is active.
- ▷ Sabbath mode switches off automatically after 120 hours if it is not manually switched off beforehand.

5.5 Storing food



WARNING

Danger of fire

- ▶ Do not use electrical appliances inside the food storage compartments of the appliance, unless they are of the type recommended by the manufacturer.

Note

- ▶ Do not store vegetables that do not support cold temperatures (such as cucumbers, eggplant, tomatoes, zucchini, and all cold-sensitive exotic fruits) in the BioFresh compartment.

The fresher the product and the better the quality, the longer it can be stored.

- ▶ When shopping, make sure the food you purchase is fresh.
- ▶ To prevent spoilage due to the transfer of bacteria: Store unpackaged animal products and plant-based products in separate compartments. This also applies for different types of meat.
If you must store food together to save space:
- ▶ Keep the food packaged.
- ▶ Each drawer can hold max. 55.12 lbs (25 kg).
- ▶ Each plate can hold 77.16 lbs (35 kg).

5.6 Storage times

Guidelines for storage at low humidity for ... 32 °F (0 °C)			
Butter	up to	90	days
Hard cheese	up to	110	days
Milk	up to	12	days
Sausage, cold cuts	up to	9	days
Poultry	up to	6	days
Pork	up to	7	days

Guidelines for storage at low humidity for ... 32 °F (0 °C)			
Beef	up to	7	days
Game	up to	7	days

Note

- ▶ Note that higher-protein foods spoil more quickly. This means that shellfish and crustaceans spoil more quickly than fish, and fish spoils more quickly than meat.

Guidelines for storage at high humidity for ... 32 °F (0 °C)			
Vegetables, lettuce			
Artichokes	up to	14	days
Celery	up to	28	days
Cauliflower	up to	21	days
Broccoli	up to	13	days
Endives	up to	27	days
Mâche	up to	19	days
Peas	up to	14	days
Kale	up to	14	days
Carrots	up to	80	days
Garlic	up to	160	days
Cabbage turnip	up to	55	days
Iceberg lettuce	up to	13	days
Herbs	up to	13	days
Leeks	up to	29	days
Mushrooms	up to	7	days
Radishes	up to	10	days
Brussels sprouts	up to	20	days
Asparagus	up to	18	days
Spinach	up to	13	days
Savoy cabbage	up to	20	days
Fruit			
Apricots	up to	13	days
Apples	up to	80	days
Pears	up to	55	days
Blackberries	up to	3	days
Dates	up to	180	days
Strawberries	up to	7	days
Figs	up to	7	days

Operation

Guidelines for storage at high humidity for ... 32 °F (0 °C)

Blueberries	up to	9	days
Raspberries	up to	3	days
Red currants	up to	7	days
Cherries, sweet	up to	14	days
Kiwi	up to	80	days
Peaches	up to	13	days
Plums	up to	20	days
Cranberries	up to	60	days
Rhubarb	up to	13	days
Gooseberries	up to	13	days
Grapes	up to	29	days

5.7 Setting the temperature

The temperature is set automatically to just above 32 °F (0 °C).

You can adjust the temperature slightly higher or lower. The temperature can be adjusted from **61** (coldest) to **69** (warmest). The default setting is **65**. If you select a setting between **61** and **64** the temperature may fall below 0 Umrechnung von ° C wurde noch nicht definiert! (0 °C), causing food to become slightly frozen.

▶ To set a higher temperature: Press the Up adjustment button *Fig. 2 (3)* until the temperature flashes in the display. Release the button.

▶ To set a lower temperature: Press the Down adjustment button *Fig. 2 (4)* until the temperature flashes in the display. Release the button.

▷ The previous value is displayed on the temperature display.

▶ To change the temperature gradually: Press the button briefly.

-or-

▶ To change the temperature continuously: Hold the button down.

▷ The values **61** to **69** are displayed while the settings are being changed.

▷ The actual temperature is displayed about 5 seconds after the last button has been pressed. The temperature slowly adjusts to the new value.

5.8 Adjusting humidity

The humidity in the appliance can be adjusted depending on the food to be stored.

With the **dry** setting, a dry climate is created that is suitable for storing packaged foods (dairy products, meat, fish, and sausage). The appliance consumes less energy in this operating mode.

With the **hydro** setting, a humid climate is created that is suitable for storing loose-leaf lettuce, vegetables and fruit with a high moisture content. When the drawers are full, this creates a cool, fresh environment with an air humidity of up to 90 %.

The humidity level in the compartment depends on the moisture content of the food inside and on how often the compartment is opened. The default setting is **dry**.

▶ To set **hydro**: Press and hold the dry/hydro button (4) until the  symbol is shown. Release the button.

▷ The dry/hydro symbol (5) lights up.

▶ To set **dry**: Press and hold the dry/hydro button (4) until the  symbol goes out. Release the button.

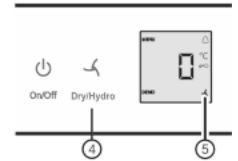

Fig. 3

5.9 Drawers

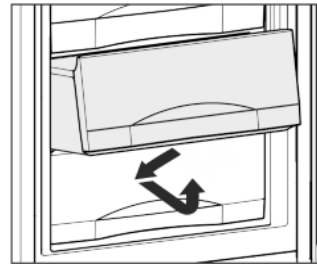

Fig. 4

▶ In order to remove the drawers with a door opening angle of 90°:

▶ Press the drawers to the side slightly when pulling them out, and then remove them from above.

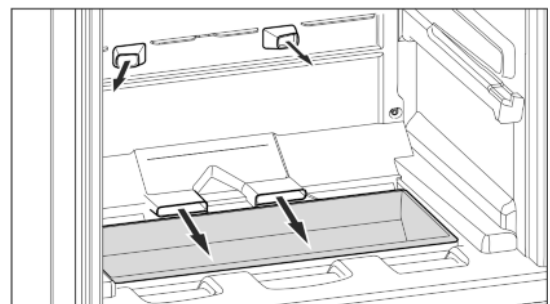

Fig. 5

▶ The vegetable drawer in the bottom recess can be used to store small items that are not needed very often.

▶ To store food to be refrigerated directly on the shelves: pull the drawer forward and lift it out.

5.10 Info system

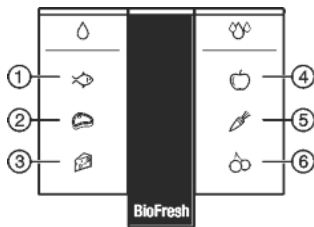

Fig. 6

- (1) Fish
- (2) Meat
- (3) Cheese
- (4) Fruit
- (5) Vegetables
- (6) Fruit

Drops indicate the storage climate for the indicated types of food.

1 drop: Dry climate

3 drops: Humid climate

5.11 Using the FlexSystem

The FlexSystem helps you store and organize your food in a clear and flexible way. It lets you clearly divide your food into fruit, vegetables or by use-by dates, for example.

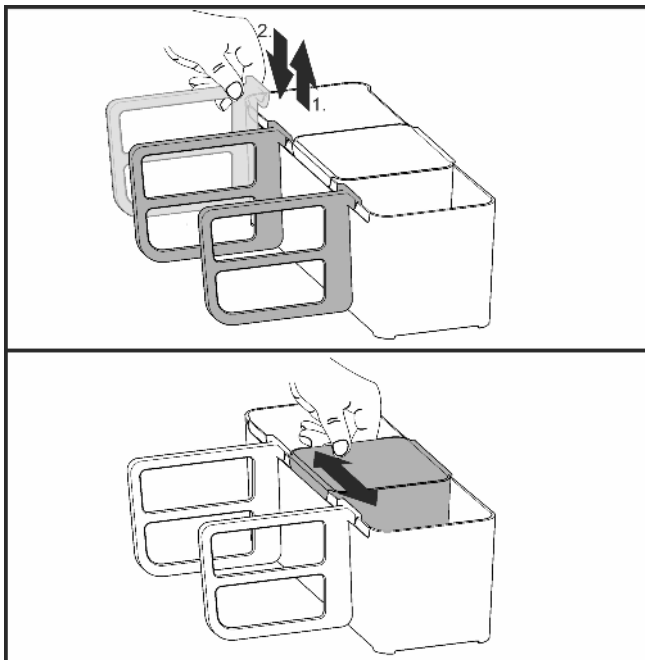

Fig. 7

- You can dismantle the FlexSystem for cleaning.

5.12 Shelves

5.12.1 Moving shelves

- To remove shelf: lift it at the front and pull out forward.
- To reinsert shelf: simply slide it in as far as it will go.

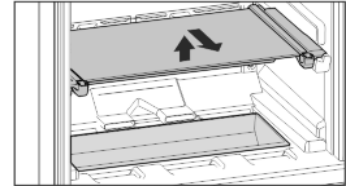

5.12.2 Dismantling shelves

- The shelves can be dismantled for cleaning.

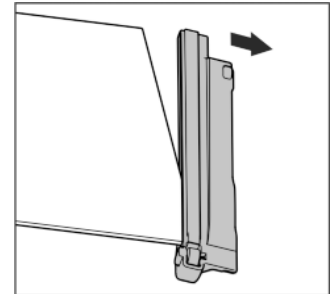

5.13 VarioSpace

In addition to the drawers, you can also take out the shelves. This gives you space for large food items such as poultry, meat, large joints of game and tall bakery items can be frozen and then presented whole.

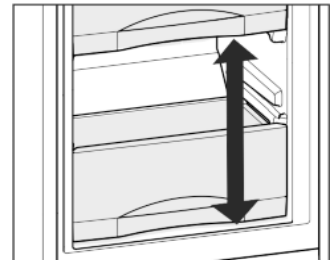

- Each drawer can hold max. 55.12 lbs (25 kg) of frozen food.
- Each plate can hold 77.16 lbs (35 kg) of frozen food.

6 Maintenance

6.1 Defrosting with NoFrost



WARNING

Risk of injury and damage

- Do not use mechanical devices or other means to accelerate the defrosting process, other than those recommended by the manufacturer.
- Do not use any electrical heating or steam cleaning equipment, naked flames or defrosting sprays for defrosting.
- Do not remove ice with sharp objects.
- Do not damage the pipes of the refrigerant circuit.

The NoFrost system defrosts the appliance automatically. The moisture condenses on the evaporator and is periodically defrosted and evaporated.

Troubleshooting.

- ▶ The appliance does not need to be defrosted manually.

6.2 Cleaning the appliance

Clean the appliance regularly.



WARNING

Danger of electric shock.

- ▶ Unplug refrigerator or disconnect power.



WARNING

Danger of fire

- ▶ Do not damage the refrigerant circuit.



WARNING

Risk of injury or damage due to hot steam.

Hot steam can cause scalding/burns and damage to surfaces.

- ▶ Do not use steam cleaners.

NOTICE

Incorrect cleaning damages the appliance.

- ▶ Do not use concentrated cleaning agents.
- ▶ Do not use steel wool or sponges that scour or scratch.
- ▶ Do not use caustic or abrasive cleaning materials or those containing sand, chloride, or acids.
- ▶ Do not use chemical solvents.
- ▶ Do not damage or remove the rating plate on the inside of the appliance. It is vital for the customer service department.
- ▶ Do not pull off, kink or damage any cables or other components.
- ▶ Do not let cleaning water get into the drain gutter, the ventilation grille and electrical parts.
- ▶ Use soft cleaning cloths and a multi-purpose cleaning agent with a neutral pH value.
- ▶ Only use food-compatible cleaning and care agents inside the appliance.

- ▶ **Empty the appliance.**
- ▶ **Disconnect the power plug.**



- ▶ Clean the **ventilation grilles** regularly.
 - ▷ Dust deposits increase energy consumption.
- ▶ Clean the **plastic surfaces, outside and inside**, by hand using lukewarm water and a little dish washing liquid.
- ▶ Most of the **equipment parts** can be dismantled for cleaning: see the respective chapter.

After cleaning:

- ▶ Wipe the appliance and accessories dry.
- ▶ Connect the appliance and switch it on again. When the temperature is sufficiently cold:
 - ▶ put the food back in the appliance.

6.3 Customer service

First check whether you can remedy the fault yourself (see 7) . If this is not the case, please contact a qualified service provider.



WARNING

Risk of injury from repairs by non-professionals.

- ▶ Repairs and work on the appliance and the power supply cable not described in the Manual (see 6) should only be carried out by a qualified service provider.

- ▶ Read the appliance designation *Fig. 8 (1)*, service no. *Fig. 8 (2)* and serial no. *Fig. 8 (3)* from the rating plate. The rating plate is located inside the appliance on the left-hand side.

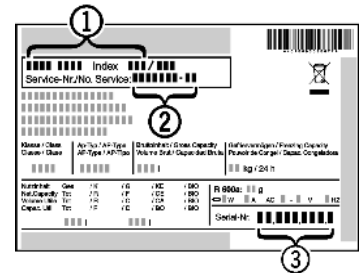

Fig. 8

- ▶ Notify a qualified service provider, specifying the fault, appliance designation *Fig. 8 (1)*, service no. *Fig. 8 (2)* and serial *Fig. 8 (3)* no.
 - ▷ This will help us to provide you with a faster and more accurate service.
- ▶ Keep the appliance closed until the Customer Service engineer arrives.
 - ▷ The food will stay cool longer.
- ▶ Disconnect the power plug (do not pull on the power cord to do this) or switch off the fuse.

6.4 Appliance Information

Make a note of this information when the appliance is installed:

Type Designation: _____
 Service Number: _____
 Appliance / Serial Number: _____
 Date of purchase: _____
 Where purchased: _____

7 Troubleshooting.

Your appliance is designed and manufactured for reliable operation and a long lifespan. If a malfunction nonetheless occurs during operation, please determine if the malfunction is due to an operating error. If a service call determines operator error, you will be charged for the costs incurred, even during the warranty period. You may be able to rectify the following problems yourself:

Defect	Cause	Remedy
The appliance does not work.	The appliance is not switched on.	▶ Switch on the appliance.
	The power plug is not properly inserted in the wall socket.	▶ Check the power plug.
	The fuse in the wall socket is not OK.	▶ Check the fuse.
	Power failure	▶ Keep the appliance closed. ▶ Protect the food: place dry ice on top of the food or use an alternate freezer, if the power failure persists for some time. ▶ Do not re-freeze defrosted food.
The compressor runs for a long time.	When less refrigeration is required, the speed-controlled compressor switches to a low speed. Although the running time is increased as a result, energy is saved.	▶ This is normal in energy-saving models.
	HydroCool is switched on.	▶ The compressor runs longer to cool down the food quickly. This is normal.
An LED at the lower rear of the appliance (near the compressor) flashes regularly every 5 seconds*.	There is a fault.	▶ Contact the customer service department (see 6) .
Noises are too loud.	The different speed levels of speed-controlled* compressors can cause them to generate various noises during operation.	▶ These noises are normal.
A gurgling sound	This sound comes from the refrigerant flowing in the refrigeration circuit.	▶ The sound is normal.
A faint clicking sound	The sound always occurs when the refrigeration unit (the motor) automatically switches on or off.	▶ The sound is normal.
A hum. It is briefly a little louder when the refrigeration unit (the motor) switches on.	Refrigeration increases automatically when the HydroCool function is activated, fresh food has just been placed in the appliance or the door has been left open for a while.	▶ These noises are normal.
	The refrigeration increases automatically when fresh food has just been placed in the appliance or the door has been left open for a while.	▶ The sound is normal.
	The ambient temperature is too high.	▶ Solution: (see 1.3)
A low hum	The sound occurs as a result of fan air flow.	▶ The sound is normal.

Troubleshooting.

Defect	Cause	Remedy
The fan continues to run.	With the “hydro” setting the fan must run for longer for operational reasons.	▶ This is normal.
Vibration noise	The appliance is not standing firmly on the floor. As a result, objects and adjoining units are set into vibration by the running refrigeration unit.	▶ Check the installation and realign the appliance if necessary.
Flow noise on the soft stop mechanism.	The sound is caused by the soft stop mechanism.	▶ The sound is normal.
The temperature display indicates: F0 to F9.	There is a fault.	▶ Contact the customer service department (see 6) .
DEMO lights up in the temperature display.	The demo mode is activated.	▶ Contact the customer service department (see 6) .
The outside surfaces of the appliance are hot*.	The heat of the refrigerant circuit is used to prevent condensate from forming.	▶ This is normal.
The temperature is not cold enough.	The door of the appliance is not closed properly.	▶ Close the appliance door.
	Insufficient ventilation.	▶ Clear and clean the ventilation grille.
	The ambient temperature is too high.	▶ Solution: (see 1.3)
	The appliance was opened too frequently or for too long.	▶ Wait to see whether the required temperature resets itself by itself. If not, contact the customer service department (see 6) .
	The temperature is incorrectly set.	▶ Set to a colder temperature and check after 24 hours
	The appliance is too near to a heat source (stove, heater etc).	▶ Change location of appliance or the heat source.
	The appliance was not properly installed in the recess.	▶ Make sure the appliance was installed correctly and the door closes properly.
The interior light does not turn on.	The appliance is not switched on.	▶ Switch on the appliance.
	The door was open for longer than 15 min.	▶ The interior light automatically switches itself off if the door remains open for approx. 15 min.
	The LED interior light is faulty or the cover is damaged:	 WARNING Risk of injury from electrical shock. Live parts are under the cover. ▶ The LED interior light should only be replaced or repaired by the Customer Service department or by engineers trained to do so.

Putting appliance out of service

Defect	Cause	Remedy
		 WARNING Risk of injury from LED lamp! The light intensity of the LED lighting corresponds to risk group RG 2. If the cover is faulty: <ul style="list-style-type: none"> ▶ Do not gaze directly at this lighting unit with optical lenses while very close to the light source. This can cause damage to your eyes.
The door seal is defective or should be replaced for other reasons.	The door seal is interchangeable. You can replace it without the use of any special tools.	▶ Contact the customer service department (see 6) :
The appliance is iced up or condensation is building.	The door seal may have slipped out of its groove.	▶ Check the door seal is well placed in the groove.

8 Putting appliance out of service

8.1 Vacation Tips

Short vacations: If you will be away for less than four weeks

- ▶ Use all perishables.

Long vacations: If you will be away for a month or more

- ▶ Remove all food from the appliance.
- ▶ Turn OFF the appliance.
- ▶ Clean the appliance (see 6.2) .
- ▶ Leave the door open to prevent unpleasant odors.
- ▷ This will also keep mold from building up.

8.2 Switch off device

- ▶ On/Off button *Fig. 2 (1)* press and hold down for about 2 seconds.
- ▷ A long beep sounds. The temperature display is dark The appliance is switched off
- ▷ If the appliance cannot be switched off, the Child Safety function is still activated (see 5.2) .



8.3 Decommissioning

- ▶ Empty the appliance.
- ▶ Switch off the appliance (see 8) .
- ▶ Pull out the power plug.
- ▶ Clean the appliance (see 6.2) .



- ▶ Leave the door open to prevent bad smells.

9 Disposing of the appliance

Follow the local regulations for the disposal of appliances. Old appliances can be dangerous. Contact the local refuse collection department for additional information.



DANGER

There is a risk of suffocation.

Children playing can shut themselves in and suffocate.

- ▶ Take the door(s) off.
- ▶ Remove the drawers.
- ▶ Leave the storage shelves in the appliance so that children cannot easily climb into the appliance.



WARNING

Danger of electric shock.

- ▶ Cut off the plug from the power cord and discard.
- ▶ Cut off the power cord from the discarded appliance. Dispose of separately from the appliance.

Ensure during and after disposal that the appliance isn't stored in the vicinity of gasoline or other flammable vapors and liquids.

When disposing of the appliance, ensure that the refrigeration circuit is not damaged to prevent uncontrolled escape of the refrigerant it contains (data on type plate) and oil.

For Service in the U.S.:

Liebherr Service Center

Toll Free: 1-866-LIEBHER or 1-866-543-2437

Service-appliances.us@liebherr.com
PlusOne Solutions, Inc.
3501 Quadrangle Blvd, Suite 120
Orlando, FL 32817

For Service in Canada:

Liebherr Service Center

Toll Free: 1-888-LIEBHER or 1-888-543-2437

www.euro-parts.ca
EURO-PARTS CANADA
39822 Belgrave Road
Belgrave, Ontario, N0G 1E0
Phone: (519) 357-3320
Fax: (519) 357-1326



www.liebherr-appliances.com