

LIEBHERR

Installation Instructions

For NoFrost Combined
Refrigerator-Freezers

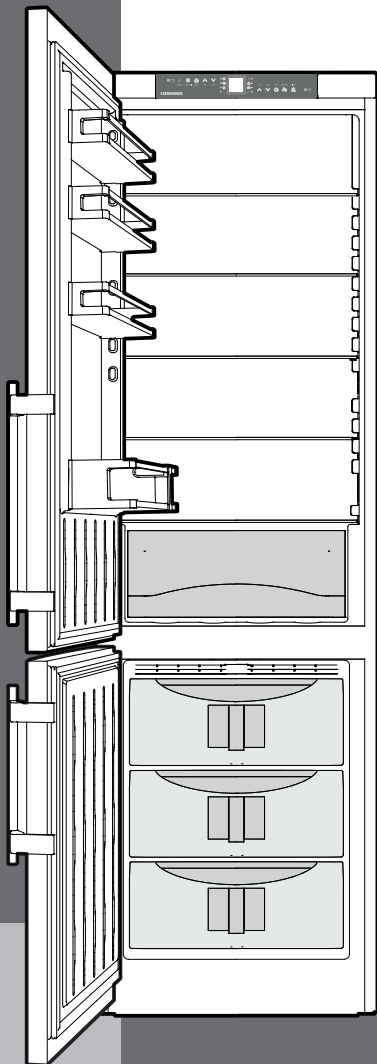

CS 1321
7085 545-00

IMPORTANT

Please Read and Follow these Instructions

These instructions contain Danger, Warning and Caution notes.

This information is important for safe and efficient installation and operation.

Always read and comply with all Danger, Warning and Caution notes!



DANGER!

Danger indicates a hazard which will cause serious injury or death if precautions are not followed.



WARNING!

Warning indicates a potentially hazardous situation which, if not avoided, could result in death or serious injury.



CAUTION!

Caution indicates a potentially hazardous situation which, if not avoided, may result in minor or moderate injury.

IMPORTANT

This indicates information that is especially relevant to a problem-free installation and operation.

Note to the Installer

It is very important to follow the instructions in the manual to ensure proper installation and operation of the unit.

Before installing the unit, be sure to thoroughly read and understand all of the information in this manual.



WARNING!

Electrocution hazard.

Do not connect to the electrical outlet before the installation is completed.

Content	Page
Please Read and Follow these Instructions.....	2
Note to the Installer.....	2
R600a Refrigerant	2
Disposal of Old Appliance	3
Disposal of Carton	3
Electrical Safety	3
Blocking for Safety.....	3
Appliance Dimensions.....	4
Cabinet Opening Dimensions	5
Unit Venting.....	6
Leveling the Appliance	6
Mounting the anti tipping device	7
Changing Over Door Hinges.....	8

R600a Refrigerant



WARNING!

The refrigerant contained within the appliance R600a is environmentally friendly, but flammable. Leaking refrigerant can ignite.

To prevent possible ignition follow the warnings below:

- **Keep ventilation openings, in the appliance enclosure or in the built-in structure, clear of obstruction.** →
- **Do not damage the refrigerant circuit.**
- **Component parts and power cords shall be replaced with like components performed by factory authorized service personnel only.**

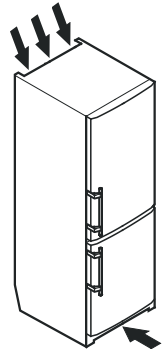

Disposal of Old Appliance



DANGER!

Risk of child entrapment.

Child entrapment and suffocation are not problems of the past.

Junked or abandoned refrigerators are still dangerous – even if they will sit for “just a few days.”

If you are getting rid of your old refrigerator, please follow these instructions to help prevent accidents.

Before you discard old appliances:

- **Take off the doors.**
- **Leave the shelves in place so that children may not easily climb inside.**
- **Cut off the power cable from the discarded refrigerator. Discard separately from the refrigerator.**
- **Be sure to follow your local requirements for disposal of appliances.**

Contact the trash collection agency in your area for additional information.

Disposal of Carton

The packaging is designed to protect the appliance and individual components during moving and is made of recyclable materials.



WARNING!

Keep packaging materials away from children. Polythene sheets and bags can cause suffocation!

Please recycle packaging material where facilities are available.

Electrical Safety

Connect this appliance to a 15 amp or 20 amp, 110-120 VAC, circuit which is grounded and protected by a circuit breaker or fuse.

We recommend using a dedicated circuit for this appliance to prevent circuit overload and the chance of interruption to the appliance.

This appliance is equipped with a three-prong (grounding) polarized plug for your protection against possible shock hazards.

Where a two-prong wall receptacle is encountered, contact a qualified electrician and have it replaced with a properly grounded three-prong receptacle in accordance with all local codes and ordinances.

Disconnect power before installing optional Side By Side Kit.



WARNING!

Electrocution hazard.

Electrical grounding required.

- **Do not remove the round grounding prong from the plug.** →
- **Do not use extension cords or ungrounded (two prong) adapters.**
- **Do not use a power cord that is frayed or damaged.**

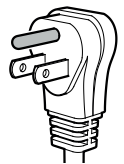

- **Do not use a power strip.** →

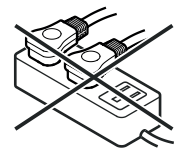

Failure to follow these instructions may result in fire, electrical shock or death.

Blocking for Safety



WARNING!

To avoid a hazard due to instability of the appliance, it must be fixed in accordance with the instructions.

PLANNING INFORMATION

Appliance Dimensions

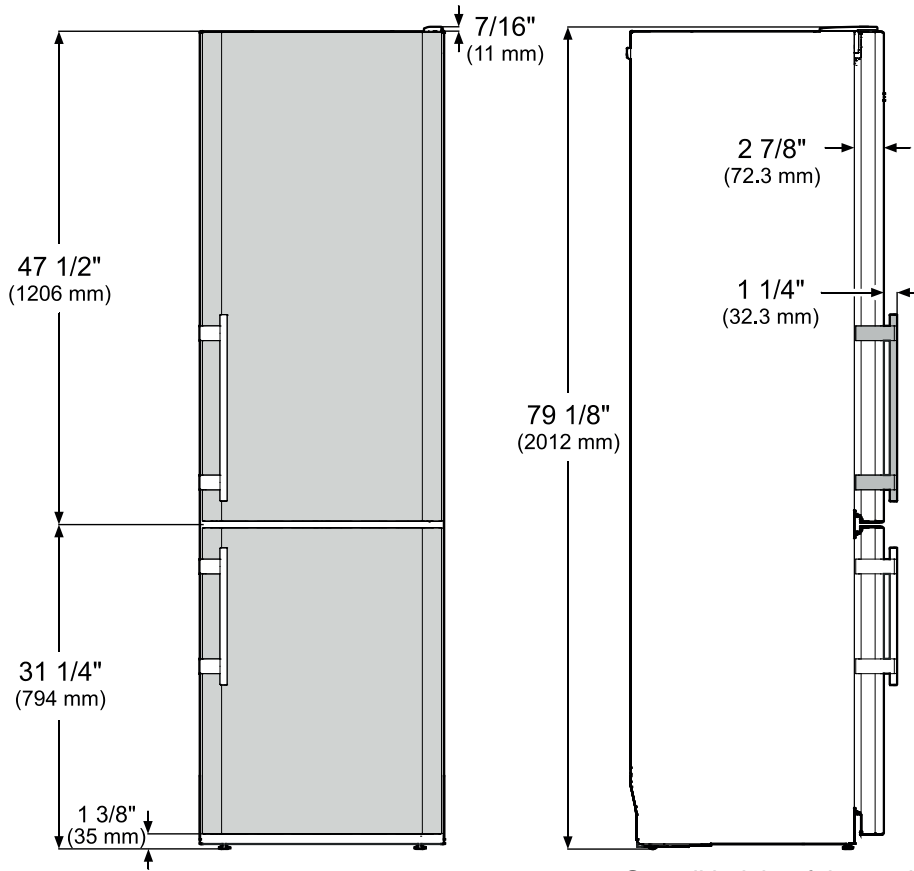

Overall height of the appliance can be increased by a maximum of 5/8" (see Leveling the appliance).

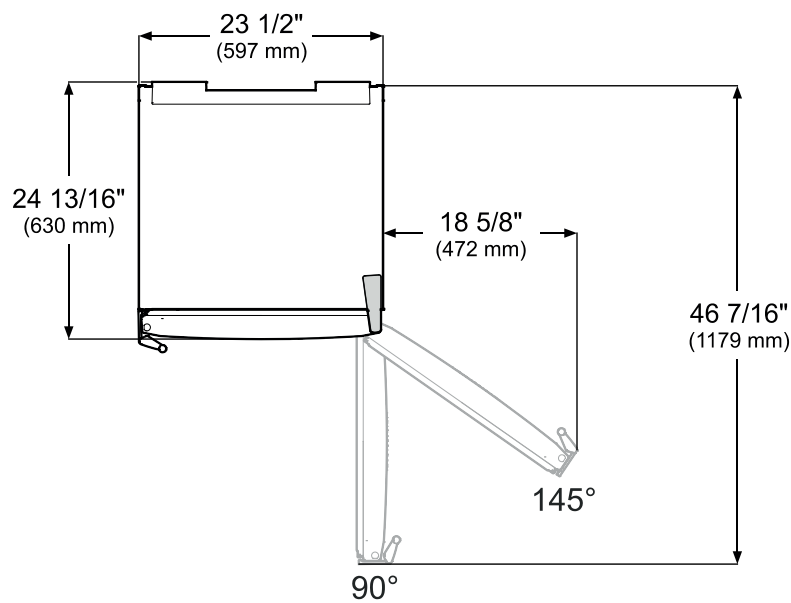

Cabinet Opening Dimensions

The appliance can be used freestanding or semi built-in.

If semi built-in, please consider the cabinet opening dimensions.

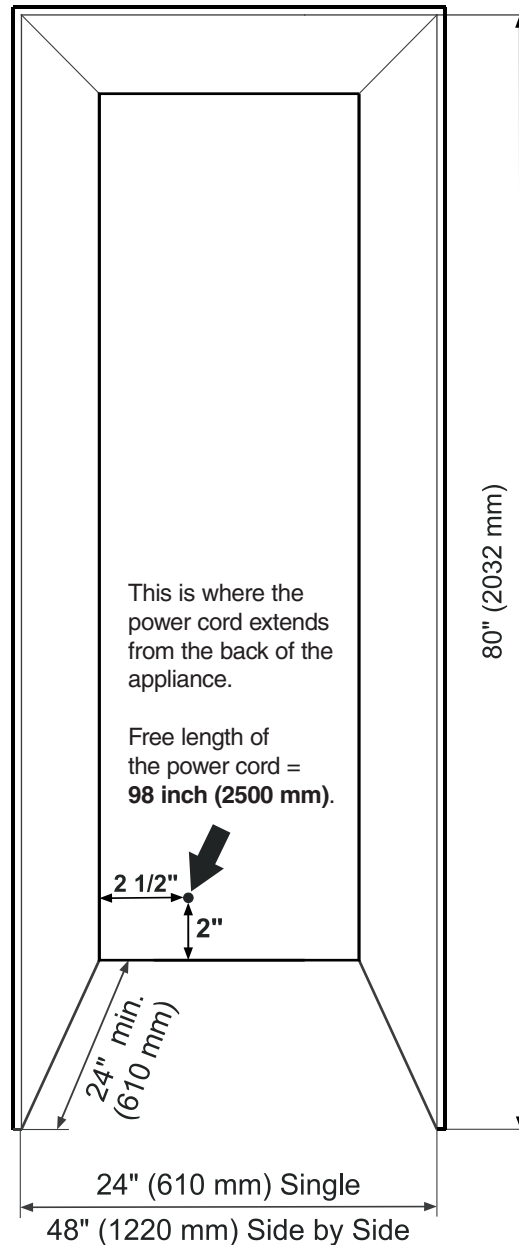

IMPORTANT

The power plug must be easily accessible so that the appliance can be disconnected from the mains quickly in an emergency. It must not be behind the back of the appliance.

Clearance on the back must be 2 inch (51 mm).

NOTE

If the gap between the rear of the appliance and the wall is less than 2 inch (51 mm), the power consumption level may increase

INSTALLATION

Unit Venting

Do not restrict the air flow.

The ventilation opening can either be directly over the appliance ①, above the cabinet and below the ceiling ② or through a vent installed in a soffit ③.

IMPORTANT

The clear ventilation cross-section must be at least 31 in² (200 cm²) from the lower ventilation opening right to the upper one.

The section below the freezer door and the floor must not be covered.

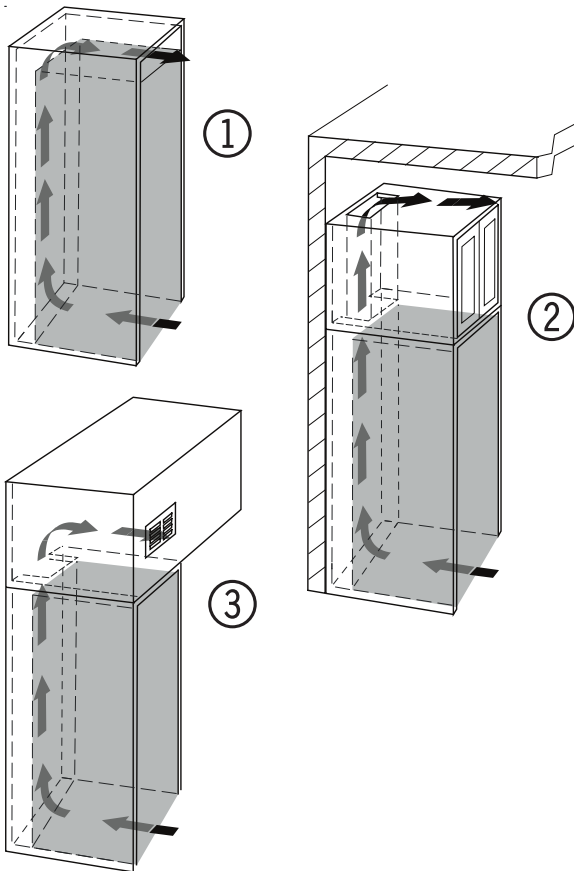

Leveling the Appliance

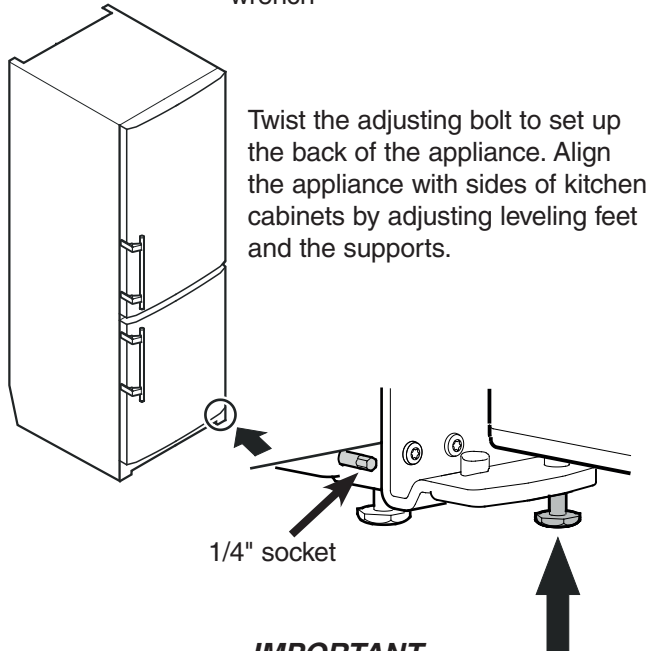
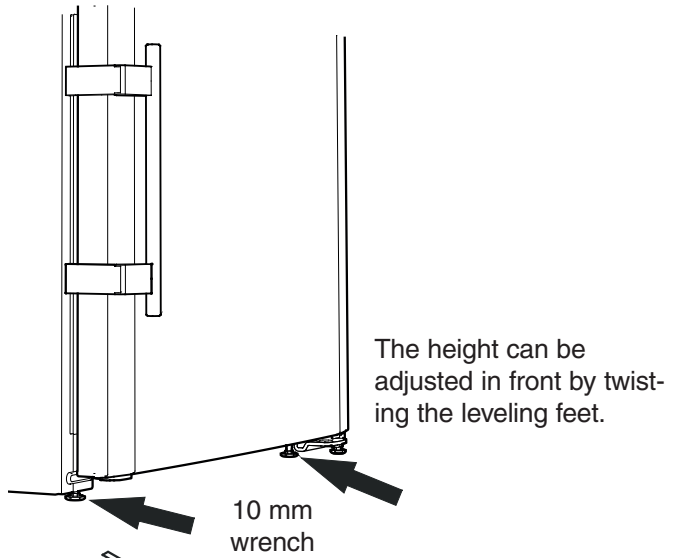

IMPORTANT

After final installation, this screw must be turned down until it has proper floor contact to support the hinge bracket.

⚠ CAUTION

Risk of injury or damage from the appliance tipping or the door falling open!

If the additional adjustable foot on the base support is not correctly positioned on the floor, there is a risk of the door falling open or the appliance tipping. This can lead to injury or property damage.

- ▶ Unscrew the additional adjustable foot on the support until it reaches the floor.
- ▶ Then turn it another 90°.

Mounting the anti tipping device

⚠ WARNING!

Tip over hazard!

The anti tipping bracket must be mounted to prevent the appliance from tipping when the fully stocked door is opened.

IMPORTANT

Be sure that there is no plumbing or electrical wiring located in this area which screws or drills could damage.

1. Mark the center of the appliance on the back wall.
2. Mount the anti tipping bracket.

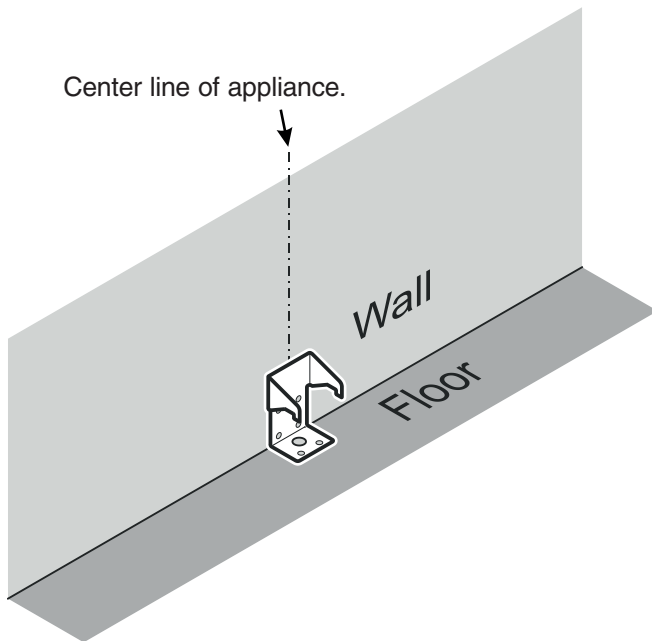

IMPORTANT

The screws for fastening the anti-tip device are not supplied with the appliance. Appropriate screws must be used for the material (wood, concrete, etc.) in which the safety device is mounted.

REVERSING DOOR HINGES

Changing Over Door Hinges

Door hinges should only be changed by a trained expert.

Changing over the door hinges requires two people.

1. Open top door, pry off door cover and pivot to the right.

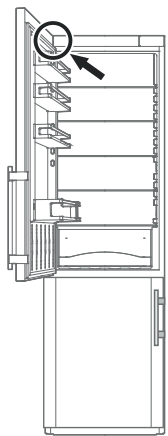
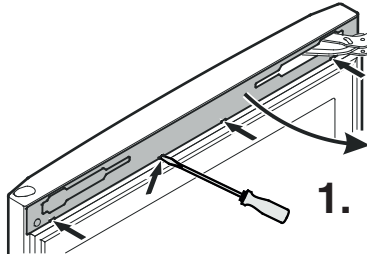

2. Let door cover hang down.
3. Slide red safety bracket over the hinge.

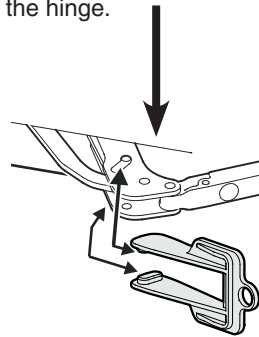

IMPORTANT

The two knobs on the safety bracket must be fully inserted into the marked openings on the hinge.

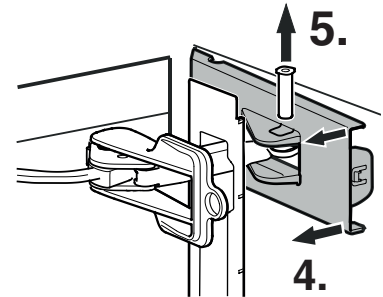
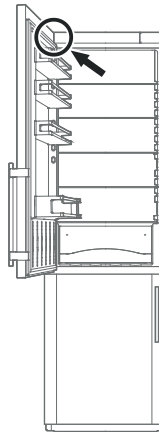
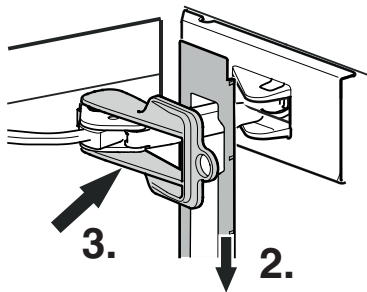

4. Pull the right-hand side of the cover approx. 1/4" (6 mm) towards you.
5. Remove pin.

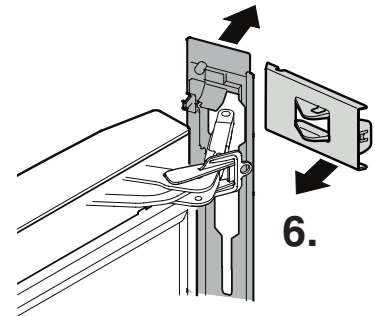
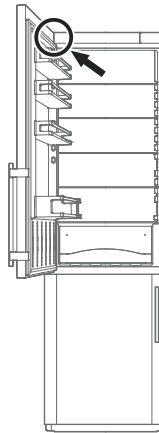

6. Open top door wide and remove covers.

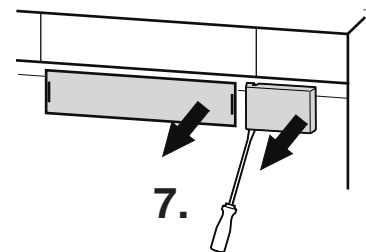
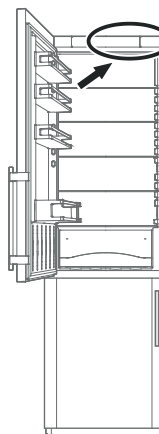

7. Pry off covers on the right and in the center.

REVERSING DOOR HINGES

IMPORTANT

The door must now be held secure by another person.

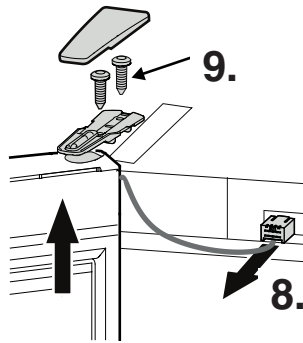
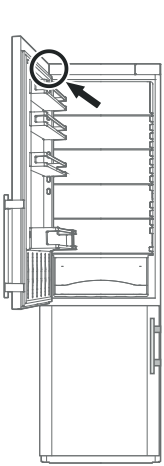

8. Disconnect the connector and pull the cable out of the guide.
9. Remove cover from upper door mounting and unscrew door.

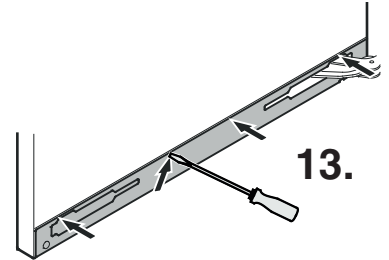
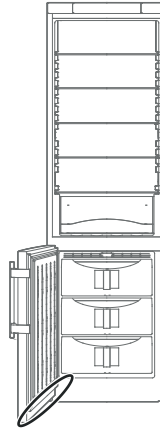

13. Open bottom door, pry off door cover.

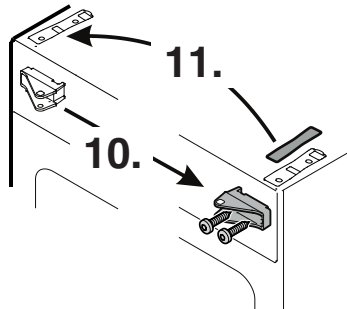
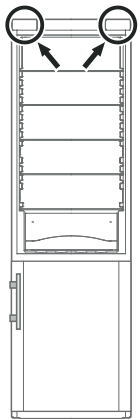

10. Transfer fastener for soft stop mechanism to the opposite side.
11. Transfer cover plate to the opposite side.

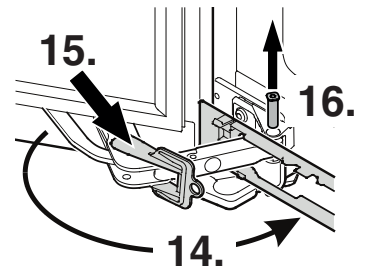
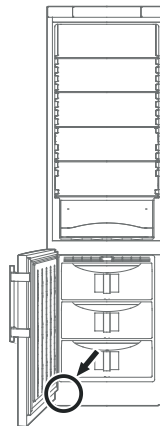

14. Pivot door cover to the right.
15. Slide red safety bracket over the hinge.
16. Remove pin.

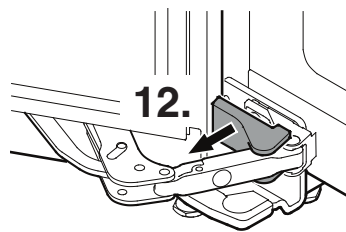
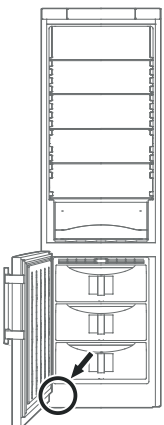

12. Remove cover.

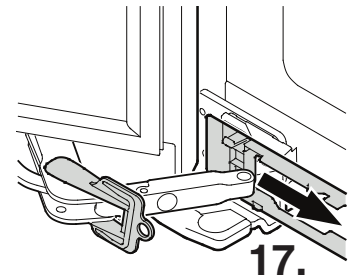
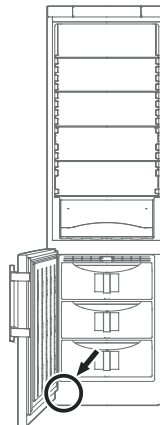

17. Open bottom door wide and remove cover.

REVERSING DOOR HINGES

IMPORTANT

The door must now be held secure by another person.

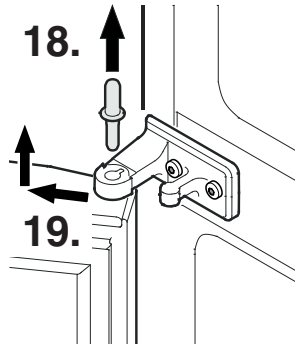
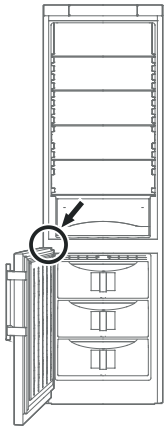

- 18. Pull out middle hinge pin.
- 19. Remove bottom door.

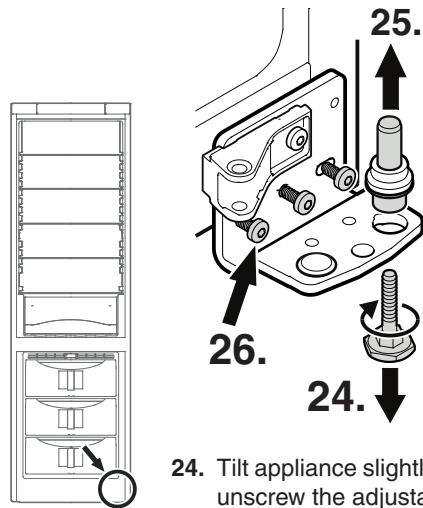

- 24. Tilt appliance slightly backwards and unscrew the adjustable foot.

- 25. Remove the hinge pin.
- 26. Unscrew hinge bracket.

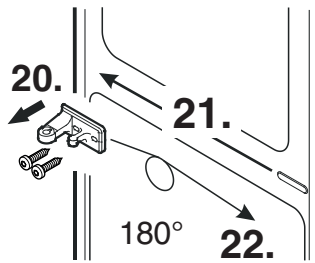
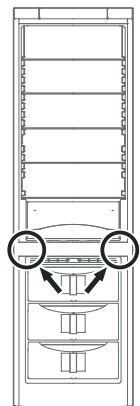

- 20. Unscrew hinge bracket.
- 21. Transfer cover plate to the opposite side.
- 22. Turn hinge bracket through 180° and screw into place.

- 27. Transfer fastener for soft stop mechanism on hinge bracket to the opposite side.

- 28. Transfer cover to the opposite side.

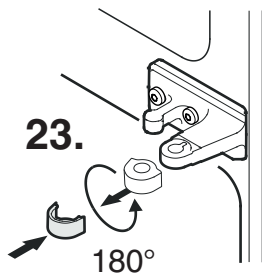
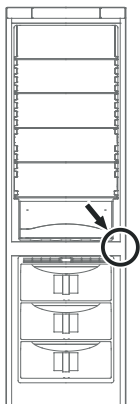
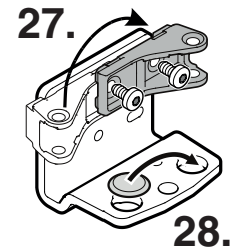

- 23. Remove hinge bushing, turn through 180° and re-fit.

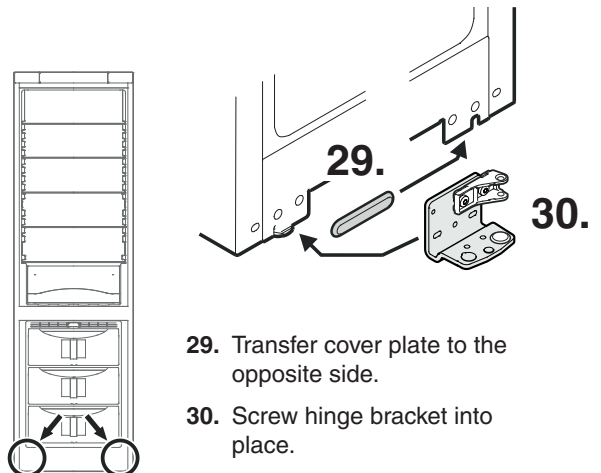

- 29. Transfer cover plate to the opposite side.

- 30. Screw hinge bracket into place.

REVERSING DOOR HINGES

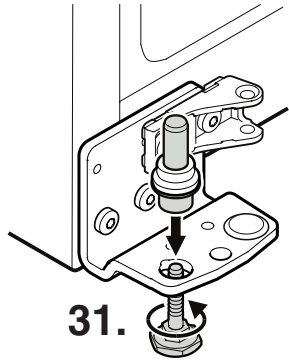
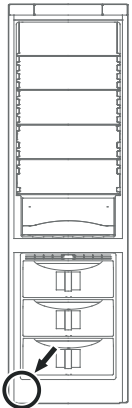

31. Tilt appliance slightly backwards, insert pin and attach using the adjustable foot.

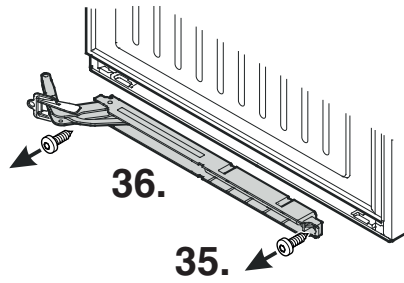

Both doors

35. Remove screw.

36. Pivot soft stop mechanism outwards on the left, pull to the left and remove.

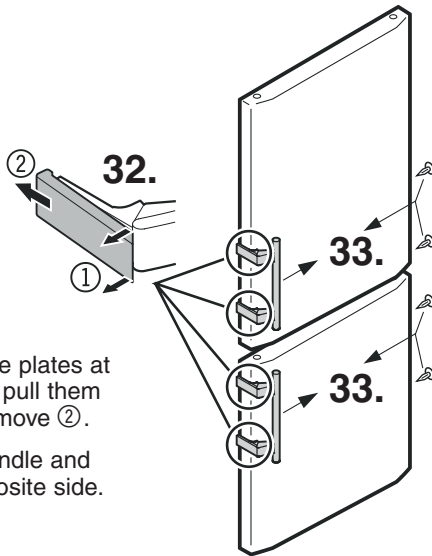

32. Release pressure plates at the front ① and pull them backwards to remove ②.

33. Transfer door handle and plugs to the opposite side.

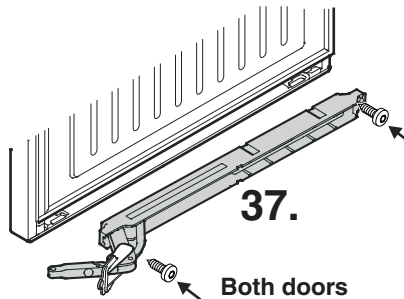

Both doors

37. Turn soft stop mechanism through 180° and re-fit on the opposite side.

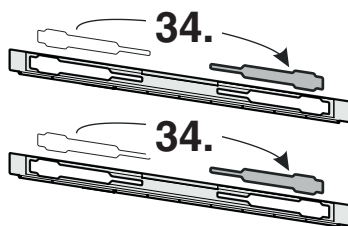

34. Transfer panels of both door covers to the opposite side.

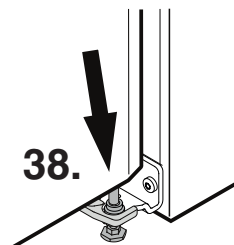
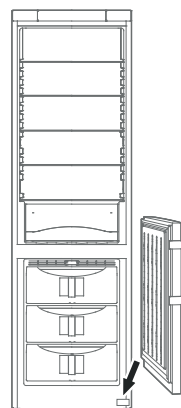

38. Suspend bottom door on hinge pin.

IMPORTANT

The door must now be held secure by another person.

REVERSING DOOR HINGES

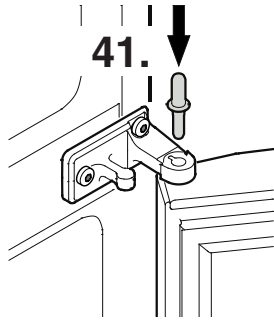
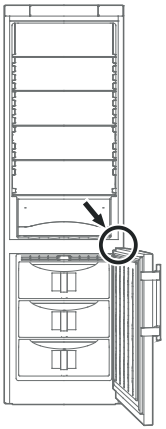

41. Insert middle hinge pin.

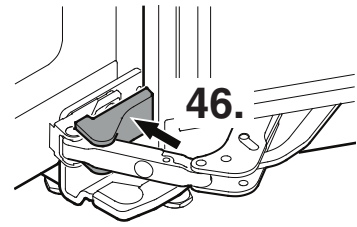
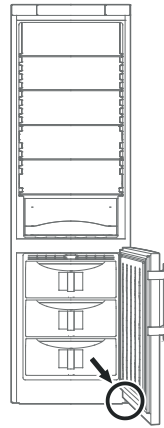

46. Click cover into place.

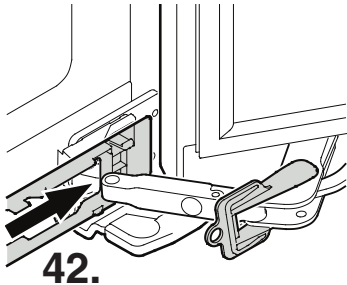
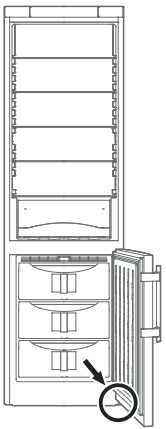

42. Slide door cover over soft stop mechanism hinge.

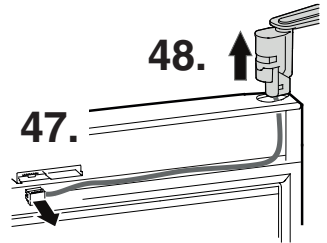
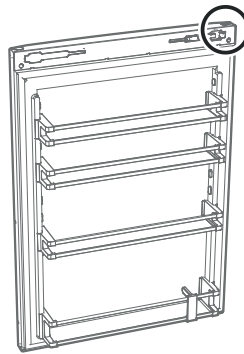

47. Disconnect the connector.

48. Using a screwdriver, push out the hinge from underneath and remove it from the door complete with the cable.

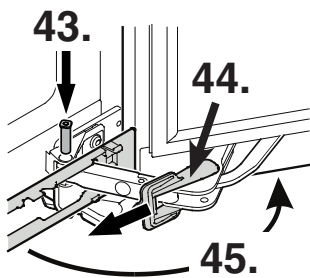
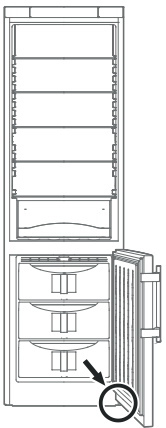

43. Move soft stop mechanism hinge to the fastener and insert pin.

44. Remove red safety bracket.

45. Pivot door cover to the right and click into place on the door.

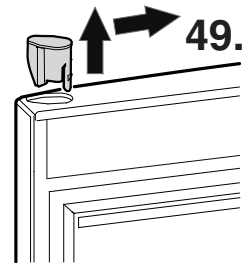
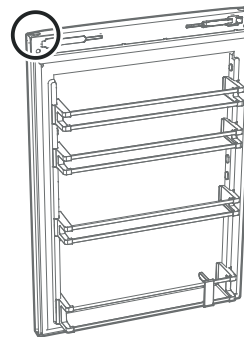

49. Using a screwdriver, push out the plug from underneath and transfer it to the opposite side.

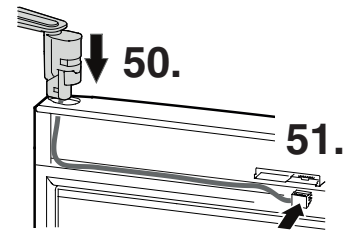
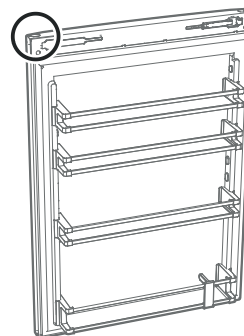

50. Feed in the cable of the hinge at the opposite side and insert hinge.

51. Plug in the connector. Place the cable in the guide.

REVERSING DOOR HINGES

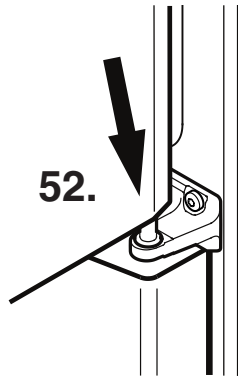
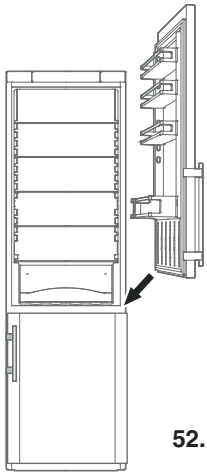

52. Suspend top door on hinge pin. For this, the door must be open at least 90°.

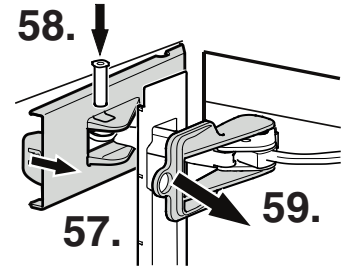
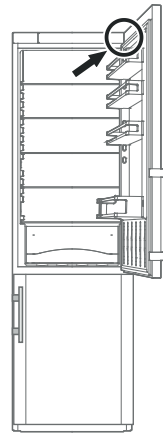

57. Pull the left-hand side of the cover approx. 1/4" (6 mm) towards you.

58. Move soft stop mechanism hinge to the fastener and insert pin.

59. Remove red safety bracket.

IMPORTANT

The door must now be held secure by another person.

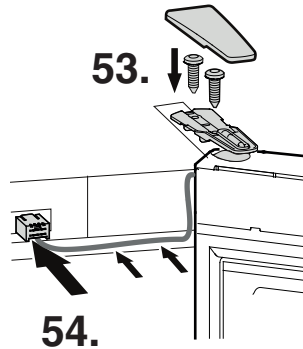
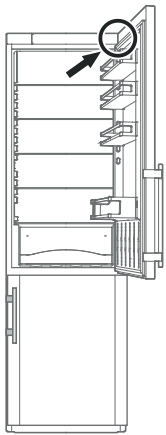

53. Secure door with screws and click cover into place.

54. Plug in the connector and insert the cable in the guide.

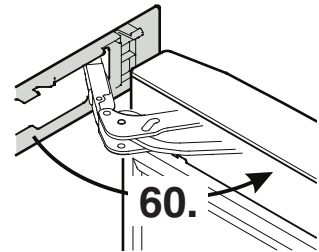
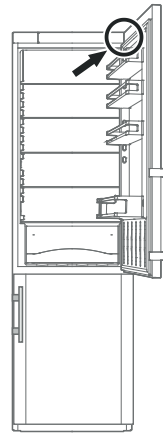

60. Pivot door cover to the right and click into place on the door.

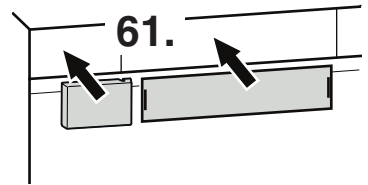
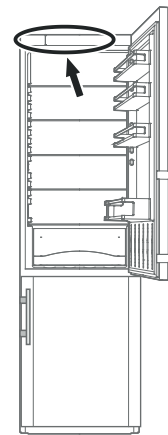

61. Click covers into place.

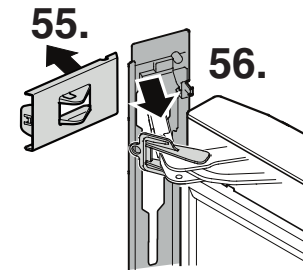
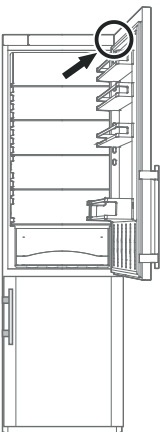

55. Click cover into place.

56. Slide door cover over soft stop mechanism hinge.

62. Place the appliance in its final position at the place of installation. Extend the adjustable foot at the bottom hinge bracket until it rests on the floor and then make a further 90° turn.

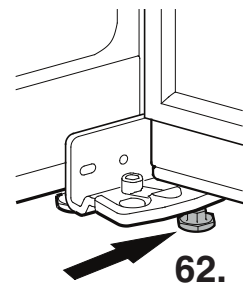

For Service in the U.S.

Liebherr Service Center

Toll Free: **1-866-LIEBHER** or **1-866-543-2437**

Email: Service-appliances.us@liebherr.com

PlusOne Solutions, Inc.

3501 Quadrangle Blvd, Suite 120

Orlando, FL 32817

For Service in Canada

Liebherr Service Center

Toll Free: **1-888-LIEBHER** or **1-888-543-2437**

www.euro-parts.ca

EURO-PARTS CANADA

39822 Belgrave Road

Belgrave, Ontario, N0G 1E0

Phone: (519) 357-3320

Fax: (519) 357-1326



www.liebherr-appliances.com