

PRODUCT MODEL NUMBERS

KUBL204E KUBL304E
KUBR204E KUBR304E

ELECTRICAL: A 115 volt, 60 Hz., AC only, 15- or 20-amp fused, grounded electrical supply is required. It is recommended that a separate circuit serving only your beverage center be provided. Use an outlet that cannot be turned off by a switch. Do not use an extension cord.

NOTE: Before performing any type of installation, cleaning, or removing a light bulb, unplug beverage center or disconnect power.

OPENING DIMENSIONS

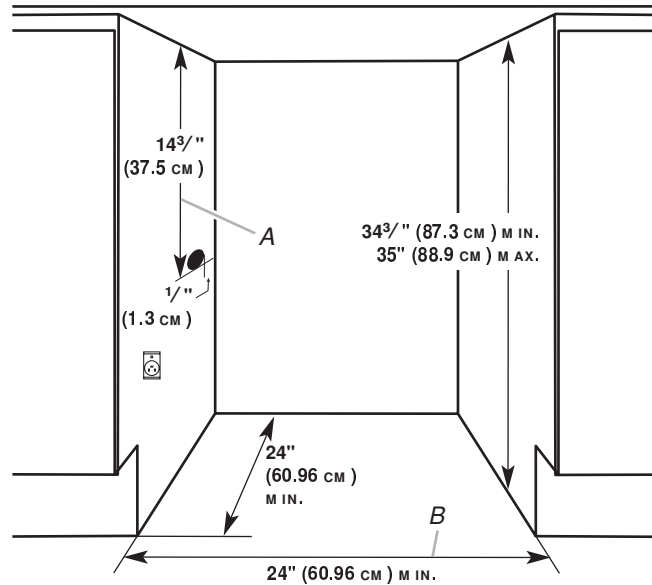

A. 14³/₈" (37.5 cm) utility opening
B. 24" (60.96 cm) minimum opening width

Height dimensions are shown with the leveling legs extended to the minimum height.

NOTE: When leveling legs are fully extended, add 5/8" (15 mm) to the height dimensions.

If the floor of the opening is not level with the kitchen floor, shim the opening to make it level with the kitchen floor.

Model	Door Swing
KUBL204E KUBL304E	Left
KUBR204E KUBR304E	Right

LOCATION REQUIREMENTS

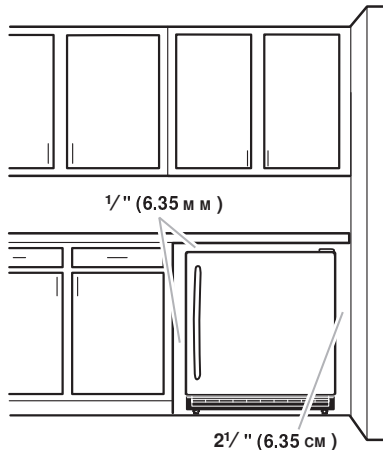

To ensure proper ventilation for your beverage center, allow for a 1/8" (6.35 mm) space on each side and at the top. When installing your beverage center next to a fixed wall, leave 2 1/8" (6.35 cm) minimum clearance on the hinge side to allow for the door to swing open.

NOTE: It is recommended that you do not install the beverage center near an oven, radiator, or other heat source. Do not install in a location where the temperature will fall below 55°F (13°C). For best performance, do not install the beverage center behind a cabinet door or block the base grille.