



COMMERCIAL-STYLE DUAL FUEL CONVECTION RANGES USE AND CARE GUIDE

CUISINIÈRES À CONVECTION À BI-COMBUSTIBLE DE STYLE COMMERCIAL GUIDE D'UTILISATION ET D'ENTRETIEN

Para una versión de estas instrucciones en español, visite www.kitchenaid.com

For questions about features, operation/performance, parts, accessories or service, call: **1-800-422-1230**
or visit our website at www.kitchenaid.com.

In Canada, for assistance, installation and service, call: **1-800-807-6777**
or visit our website at www.KitchenAid.ca.

Au Canada, pour assistance, installation ou service composez le **1-800-807-6777**
ou visitez notre site web à www.KitchenAid.ca.

Table of Contents

















SAFETY INFORMATION	3
 The Anti-Tip Bracket	4
PARTS AND FEATURES	6
 Range	6
Oven Interior	6
Electronic Oven Controls	7
COOKTOP FEATURES	8
 Burners	8
Grill	9
Chrome Electric Griddle	10
USING YOUR OVEN	11
 Control Panel	11
Oven Display	11
Functions	11
Options	12
Know Your Oven	15
Traditional Cooking	17
Special Modes	20
CARE AND CLEANING	22
 Cooktop Surface	22
Sealed Surface Burners	22
Porcelain-Coated Grates and Caps	23
Grill	23
Griddle	25
Cooktop Controls	26
Stainless Steel	26
Control Panel	27
Door Exterior	27
Door Interior	27
Oven Racks	27
Oven Cavity	27
Self-Cleaning the Oven	28
Oven Lights	29
TROUBLESHOOTING	30
	
ASSISTANCE OR SERVICE	32
	
ACCESSORIES	32
	
WARRANTY	33

Table des matières

INFORMATIONS DE SÉCURITÉ	34
 Pied antibasculement	35
PIÈCES ET CARACTÉRISTIQUES	37
 Cuisinière	37
Intérieur du four	37
Commandes électroniques du four	38
CARACTÉRISTIQUES DE LA TABLE DE CUISSON	39
 Brûleurs	39
Grill	39
Plaque à frire électrique chromée	41
UTILISATION DU FOUR	42
 Tableau de commande	42
Affichage	42
Fonctions	42
Options	44
Se familiariser avec le four	47
Cuisson traditionnelle	49
Modes Spéciaux	52
ENTRETIEN ET NETTOYAGE	55
 Surface de la table de cuisson	55
Brûleurs de surface scelles	55
Grilles et chapeaux emailés	56
Gril	56
Plaque à frire	58
Commandes de la table de cuisson	59
Acier inoxydable	59
Tableau de commande	60
Extérieur de la porte	60
Intérieur de la porte	60
Grilles de four	60
Cavité du four	60
D'autonettoyage du four	61
Lampes du four	62
DÉPANNAGE	63
	
ASSISTANCE OU SERVICE	65
	
ACCESSOIRES	65
	
GARANTIE	66



Your safety and the safety of others are very important.

We have provided many important safety messages in this manual and on your appliance. Always read and obey all safety messages.



This is the safety alert symbol.

This symbol alerts you to potential hazards that can kill or hurt you and others.

All safety messages will follow the safety alert symbol and either the word “DANGER” or “WARNING.” These words mean:

⚠ DANGER

You can be killed or seriously injured if you don't immediately follow instructions.

⚠ WARNING

You can be killed or seriously injured if you don't follow instructions.

All safety messages will tell you what the potential hazard is, tell you how to reduce the chance of injury, and tell you what can happen if the instructions are not followed.

WARNING: If the information in this manual is not followed exactly, a fire or explosion may result causing property damage, personal injury or death.

- Do not store or use gasoline or other flammable vapors and liquids in the vicinity of this or any other appliance.
- **WHAT TO DO IF YOU SMELL GAS:**
 - Do not try to light any appliance.
 - Do not touch any electrical switch.
 - Do not use any phone in your building.
 - Immediately call your gas supplier from a neighbor's phone. Follow the gas supplier's instructions.
 - If you cannot reach your gas supplier, call the fire department.
- Installation and service must be performed by a qualified installer, service agency or the gas supplier.

WARNING: Gas leaks cannot always be detected by smell.

Gas suppliers recommend that you use a gas detector approved by UL or CSA.

For more information, contact your gas supplier.

If a gas leak is detected, follow the “What to do if you smell gas” instructions.

State of California Proposition 65 Warnings:

WARNING: This product contains one or more chemicals known to the State of California to cause cancer.

WARNING: This product contains one or more chemicals known to the State of California to cause birth defects or other reproductive harm.



SAFETY INFORMATION

THE ANTI-TIP BRACKET

The range will not tip during normal use. However, the range can tip if you apply too much force or weight to the open door without the anti-tip bracket fastened down properly.



⚠ WARNING

Tip Over Hazard

A child or adult can tip the range and be killed.

Verify the anti-tip bracket has been properly installed and engaged per installation instructions.

Re-engage the anti-tip bracket if the range is moved.

Do not operate range without anti-tip bracket installed and engaged.

Failure to follow these instructions can result in death or serious burns to children and adults.

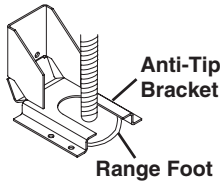

To verify the anti-tip bracket is installed and engaged:

- Slide range forward.
- Look for the anti-tip bracket securely attached to floor or wall.
- Slide range back so rear range foot is under anti-tip bracket.
- See installation instructions for details.

IMPORTANT SAFETY INSTRUCTIONS

WARNING: To reduce the risk of fire, electrical shock, injury to persons, or damage when using the range, follow basic precautions, including the following:

- **WARNING:** TO REDUCE THE RISK OF TIPPING OF THE RANGE, THE RANGE MUST BE SECURED BY PROPERLY INSTALLED ANTI-TIP DEVICES. TO CHECK IF THE DEVICES ARE INSTALLED PROPERLY, SLIDE RANGE FORWARD, LOOK FOR ANTI-TIP BRACKET SECURELY ATTACHED TO FLOOR OR WALL, AND SLIDE RANGE BACK SO REAR RANGE FOOT IS UNDER ANTI-TIP BRACKET.
- **WARNING:** TO REDUCE THE RISK OF BURNS, DO NOT MOVE THE RANGE WHILE HOT. THIS RANGE IS PROVIDED WITH WHEELS TO FACILITATE MOVEMENT. TO REDUCE THE RISK OF INJURY DUE TO TIPPING OF THE APPLIANCE, VERIFY THE REINSTALLATION OF THE RANGE INTO THE ANTI-TIP DEVICE PROVIDED, AND EXTEND LEVELING FEET AFTER RETURNING THE RANGE TO THE ORIGINAL INSTALLED POSITION.
- **WARNING:** NEVER use this appliance as a space heater to heat or warm the room. Doing so may result in carbon monoxide poisoning and overheating of the oven.
- **WARNING:** NEVER cover any slots, holes or passages in the oven bottom or cover an entire rack with materials such as aluminum foil. Doing so blocks air flow through the oven and may cause carbon monoxide poisoning. Aluminum foil linings may also trap heat, causing a fire hazard.
- **CAUTION:** Do not store items of interest to children in cabinets above a range or on the backguard of a range – children climbing on the range to reach items could be seriously injured.
- Do Not Leave Children Alone – Children should not be left alone or unattended in area where the range is in use. They should never be allowed to sit or stand on any part of the range.

- Wear Proper Apparel – Loose-fitting or hanging garments should never be worn while using the range.
- User Servicing – Do not repair or replace any part of the range unless specifically recommended in the manual. All other servicing should be referred to a qualified technician.
- Storage in or on the Range – Flammable materials should not be stored in an oven or near surface units.
- Do Not Use Water on Grease Fires – Smother fire or flame or use dry chemical or foam-type extinguisher.
- Use Only Dry Potholders – Moist or damp potholders on hot surfaces may result in burns from steam. Do not let potholder touch hot heating elements. Do not use a towel or other bulky cloth.
- DO NOT TOUCH SURFACE UNITS OR AREAS NEAR UNITS – Surface units may be hot even though they are dark in color. Areas near surface units may become hot enough to cause burns. During and after use, do not touch, or let clothing or other flammable materials contact surface units or areas near units until they have had sufficient time to cool. Among those areas are the cooktop and surfaces facing the cooktop.
- Never Leave Surface Units Unattended at High Heat Settings – Boilover causes smoking and greasy spillovers that may ignite.
- Glazed Cooking Utensils – Only certain types of glass, glass/ceramic, ceramic, earthenware, or other glazed utensils are suitable for range-top service without breaking due to the sudden change in temperature.

SAVE THESE INSTRUCTIONS



IMPORTANT SAFETY INSTRUCTIONS

- **Utensil Handles Should Be Turned Inward and Not Extend Over Adjacent Surface Units** – To reduce the risk of burns, ignition of flammable materials, and spillage due to unintentional contact with the utensil, the handle of a utensil should be positioned so that it is turned inward, and does not extend over adjacent surface units.
 - **Clean Cooktop With Caution** – If a wet sponge or cloth is used to wipe spills on a hot cooking area, be careful to avoid steam burn. Some cleaners can produce noxious fumes if applied to a hot surface.
 - **Use Care When Opening Door** – Let hot air or steam escape before removing or replacing food.
 - **Do Not Heat Unopened Food Containers** – Build-up of pressure may cause container to burst and result in injury.
 - **Keep Oven Vent Ducts Unobstructed.**
 - **Placement of Oven Racks** – Always place oven racks in desired location while oven is cool. If rack must be moved while oven is hot, do not let potholder contact hot heating element in oven.
 - **DO NOT TOUCH HEATING ELEMENTS OR INTERIOR SURFACES OF OVEN** – Heating elements may be hot even though they are dark in color. Interior surfaces of an oven become hot enough to cause burns. During and after use, do not touch, or let clothing or other flammable materials contact heating elements or interior surfaces of oven until they have had sufficient time to cool. Other surfaces of the appliance may become hot enough to cause burns – among these surfaces are oven vent openings and surfaces near these openings, oven doors, and windows of oven doors.
 - **Proper Installation** – The range, when installed, must be electrically grounded in accordance with local codes or, in the absence of local codes, with the *National Electrical Code, ANSI/NFPA 70*. In Canada, the range must be electrically grounded in accordance with Canadian Electrical Code. Be sure the range is properly installed and grounded by a qualified technician.
 - **Disconnect the electrical supply before servicing the appliance.**
 - **Injuries may result from the misuse of appliance doors or drawers such as stepping, leaning, or sitting on the doors or drawers.**
 - **Maintenance** – Keep range area clear and free from combustible materials, gasoline, and other flammable vapors and liquids.
 - **Top burner flame size should be adjusted so it does not extend beyond the edge of the cooking utensil.**
- For self-cleaning ranges –**
- **Do Not Clean Door Gasket** – The door gasket is essential for a good seal. Care should be taken not to rub, damage, or move the gasket.
 - **Do Not Use Oven Cleaners** – No commercial oven cleaner or oven liner protective coating of any kind should be used in or around any part of the oven.
 - **Clean Only Parts Listed in Manual.**
 - **Before Self-Cleaning the Oven** – Remove broiler pan and other utensils. Wipe off all excessive spillage before initiating the cleaning cycle.
- For units with ventilating hood –**
- **Clean Ventilating Hoods Frequently** – Grease should not be allowed to accumulate on hood or filter.
 - **When flambéing foods under the hood, turn the fan on.**

SAVE THESE INSTRUCTIONS



PARTS AND FEATURES

This manual covers several different models. The range you have purchased may have some or all of the items listed. The locations and appearances of the features shown here may not match those of your model. Refer to this manual or the Frequently Asked Questions (FAQs) section of our website at www.kitchenaid.com for more detailed instructions. In Canada, refer to the Customer Service Section at www.kitchenaid.ca.

RANGE

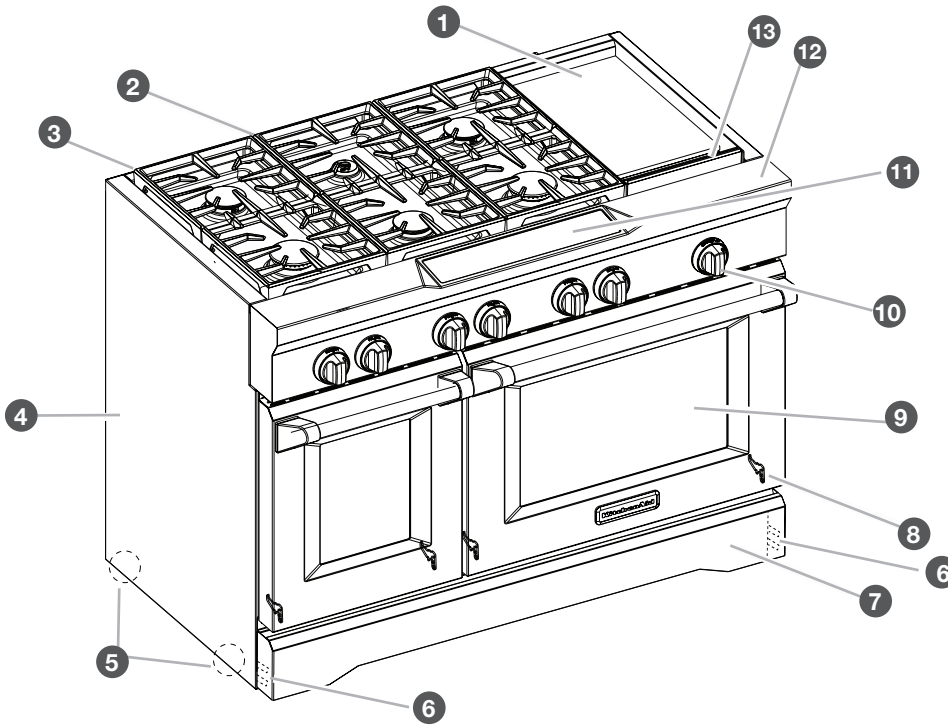

- 1 Electric griddle (on some models)
- 2 Cooktop grate
- 3 Island trim
- 4 Side panels
- 5 Roller feet
- 6 Leveling rods
- 7 Lower panel/kick plate
- 8 Oven doors
- 9 Window
- 10 Control knobs
- 11 Control panel
- 12 Culinary ledge
- 13 Drip tray (on griddle models)

48" range shown

OVEN INTERIOR

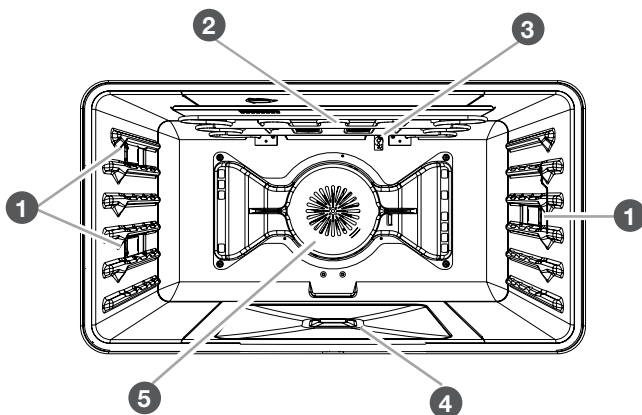

- 1 Halogen lights
- 2 Broil elements
- 3 Oven cavity sensor
- 4 Hidden element
- 5 Convection fan(s)



ELECTRONIC OVEN CONTROLS

30" (76.2 CM) AND 36" (91.4 CM)

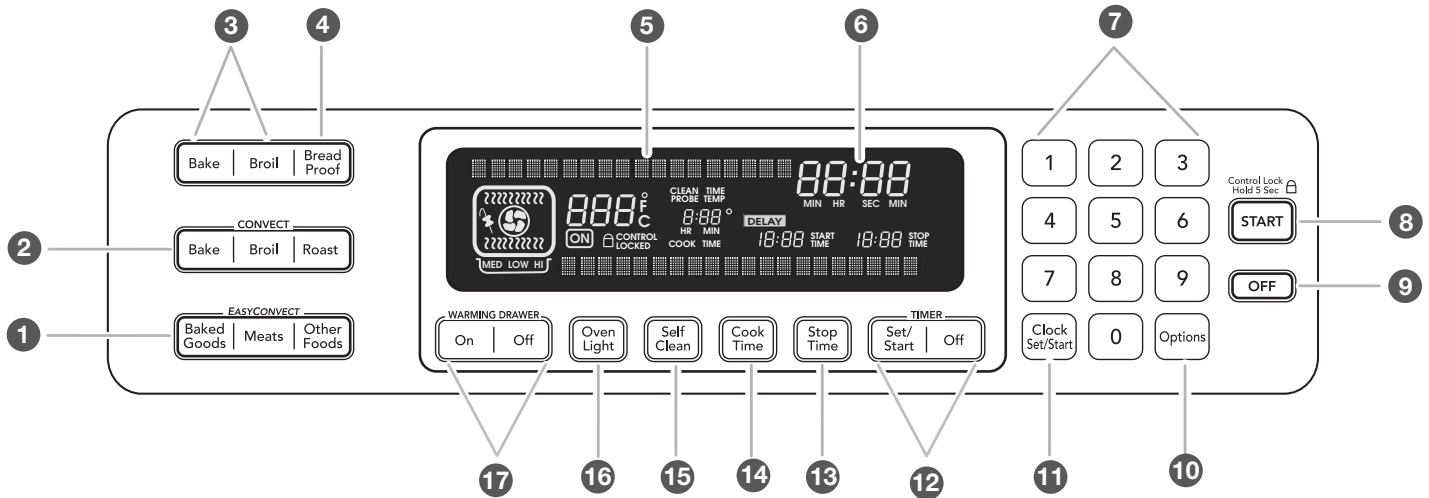

48" (121.9 CM)

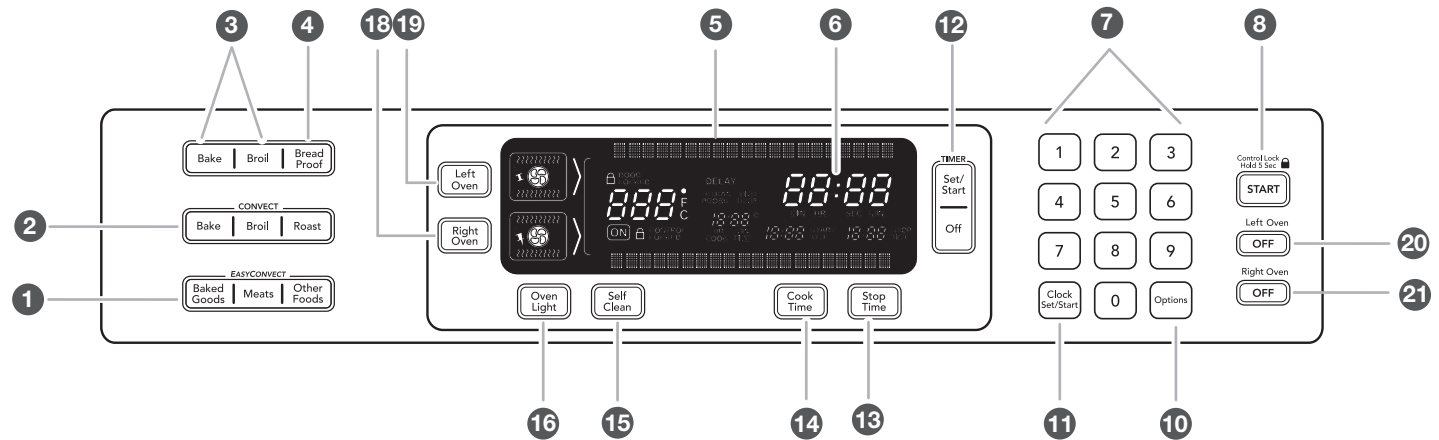

- | | | | |
|-----------------------------|--|---------------------------------------|--------------------------|
| 1 EasyConvect™ conversion | 7 Number pads | 11 Clock set/start | 17 Warming drawer on/off |
| 2 Convection oven modes | 8 Start (control lock/unlock when pressed for 5 seconds) | 12 Timer | 18 Right oven selector |
| 3 Oven modes | 9 Off | 13 Stop time | 19 Left oven selector |
| 4 Bread proof mode | 10 Options selection pad | 14 Cook time (length of cooking time) | 20 Left oven off |
| 5 Oven display | | 15 Self-clean | 21 Right oven off |
| 6 Clock/time of day display | | 16 Oven light (on/off) | |



COOKTOP FEATURES

BURNERS

WARNING



Fire Hazard

Do not let the burner flame extend beyond the edge of the pan.

Turn off all controls when not cooking.

Failure to follow these instructions can result in death or fire.

- Check that the control knob is pressed completely down on the valve shaft. If the spark igniter still does not operate, call a trained repair specialist.
- When the control knobs for any small or medium burner are turned to the LITE position, all small and medium burners will click. When the control knob for the large burner is turned to the LITE position, these burners will click independent of the other burners. In both cases, only the burner with the control knob turned to LITE will produce a flame.

REMEMBER: When range is in use or during the Self-Cleaning cycle, the entire cooktop area may become hot.

Reignition Feature

During cooktop use, if one or more burners are extinguished due to external causes (such as a water spill, wind, or ventilation draft), the ignition system will turn on to reignite the flame. When the flame comes back on, the system will stop sparking. If the draft in the room is not removed, occasional sparking may continue. Sparking may also occasionally occur when using the low setting on a burner.

To Set a Burner:

1.	2.
Push in and turn counterclockwise to LITE.	Turn knob counterclockwise between HI and LO.

Push in one more time to get from LO to HI.

In Case of Power Failure

Hold a lit match near a burner, and turn knob counterclockwise to HI. After burner lights, turn knob to the desired setting.

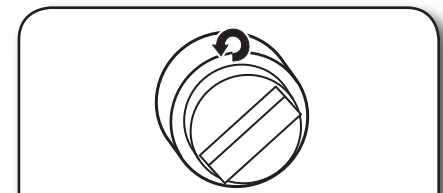
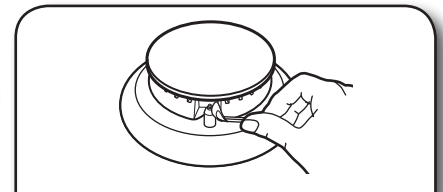

BTU/Hr	BURNER APPEARANCE	FEATURES
Ultra-Power™ dual-flame burner		This burner has an upper and lower level of flame. The Power HI setting uses both flame levels at full power to provide the highest heat. It is ideal for cooking large quantities of food or liquid, and using large pots and pans. The Simmer HI and LO settings use the upper flame only.
Medium burner		This burner is ideal for cooking smaller quantities of food and melting chocolate or butter.
Simmer burner		This burner reaches a low of 500 BTU/Hr. It provides the gentle, low temperatures required for simmering soups, stewing, and melting delicate ingredients like butter, cheese, and chocolate.

Igniting Burners:

- Electric igniters automatically light the surface burners when control knobs are turned to LITE.
- Before setting a control knob, place filled cookware on the grate. Do not operate a burner using empty cookware or without any cookware on the grate.
- Visually check that the burner has lit. If the burner does not ignite, listen for the clicking sound. If you do not hear the igniter click, turn off the burner. Check for a tripped circuit breaker or blown fuse.



Sealed Surface Burners

Sealed surface burners are designed to minimize gaps and seams that can allow liquids and spills to get under the cooktop. This design makes cleanup quick and easy.

Stacked Power Burner

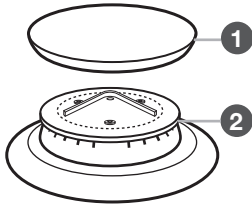

- 1 Burner cap
- 2 Burner base
- 3 Choke (for use with medium burner, LP gas only)

Medium Burner

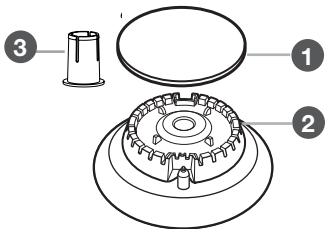

Simmer/Melt Burner

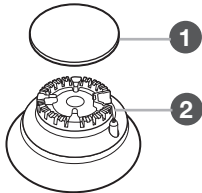

IMPORTANT: Do not obstruct the flow of combustion and ventilation air around the burner grate edges.

Burner cap: Always keep the burner cap in place when using a surface burner. A clean burner cap will help avoid poor ignition and uneven flames. Always clean the burner cap after a spillover, and routinely remove and clean the caps according to the "Care and Cleaning" section.

Gas opening: Gas must flow freely throughout the gas opening for the burner to light properly. Keep this area free of soil, and do not allow spills, food, cleaning agents, or any other material to enter the gas opening. Keep spillovers out of the gas opening by always using a burner cap.

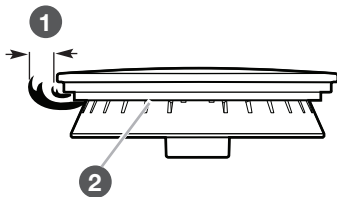

- 1 1-1/2" (25-38 mm)
- 2 Burner ports

Burner ports: Check burner flames occasionally for proper size and shape as shown above. A good flame is blue in color, not yellow. Keep this area free of soil, and do not allow spills, food, cleaning agents, or any other material to enter the burner ports.

GRILL (ON SOME MODELS)

The grill module consists of a cast-iron grate, a wave tray, a flame spreader, a burner assembly, 2 grease trays and a drip tray.

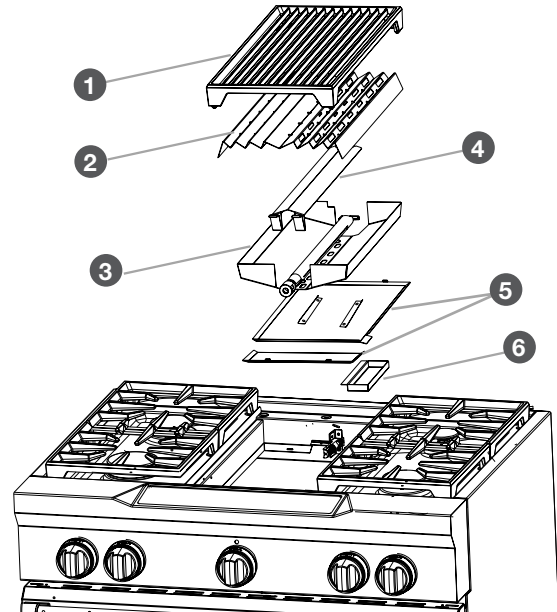

- 1 Grill grate
- 2 Wave tray
- 3 Burner assembly
- 4 Flame spreader
- 5 Grease trays
- 6 Drip tray



When using the grill, follow the guidelines below:

- Trim excess fat to reduce spattering. Slit the remaining fat on the edges to avoid curling.
- Allow space between food on the grill. Crowding food will result in uneven cooking.
- Use a metal spatula or tongs to turn food.
- Steaks, chops and hamburgers should be turned only once to avoid loss of juices.
- For even cooking, foods such as chicken quarters should be turned several times.
- To check for doneness of meats and poultry, use an instant read thermometer or make a small cut in the center of the food. This will avoid loss of juices.
- Do not leave the grill unattended while cooking.
- To avoid damage to the grill, do not use aluminum foil, charcoal or wood chips.
- To avoid damage to cookware, do not place cookware on the grill when in use. Food should be cooked directly on the grill grate.



COOKTOP FEATURES

To Use:

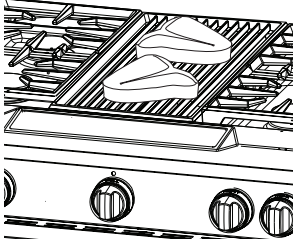
<p>1. Turn on overhead range hood.</p>	<p>4.</p>  <p>Turn knob to MED and allow grill to preheat for 15 minutes.</p>
<p>2. Apply vegetable oil, if desired. Apply a light coating of vegetable oil or nonstick cooking spray to grill grate.</p>	<p>5.</p>  <p>Turn knob to desired cook setting.</p>
<p>3.</p>  <p>Push in and turn knob to LITE/Hi. The flame will ignite in 1-4 seconds.</p>	<p>6.</p>  <p>Place food on grill.</p>

CHROME ELECTRIC GRIDDLE (ON SOME MODELS)

The chrome electric griddle provides the perfect cooking surface for grilled sandwiches, pancakes, eggs, burgers, sautéed vegetables, and many more family favorites. The attractive low-stick surface is designed to make cleanup easy.

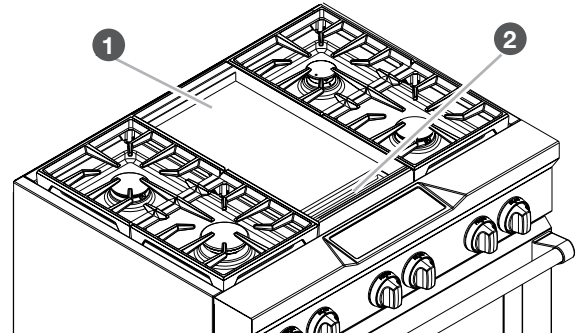

- 1** Griddle
- 2** Drip tray

The chrome electric griddle system provides an evenly heated cooking surface.

- Be sure plastic film has been removed, and wash with hot water before first use.
- To avoid scratching the griddle, do not place any pots or pans on the griddle. Use only heat resistant plastic or wooden utensils.
- The griddle surface is ready to use and does not need to be seasoned.
- Pouring cold water on a hot griddle may warp the griddle, resulting in an uneven cooking surface.

To Use:

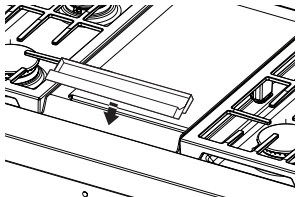
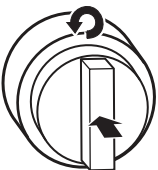
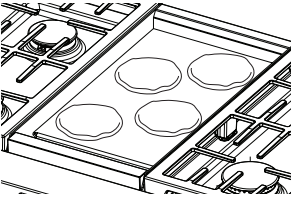
<p>1.</p>  <p>Position drip tray.</p>	
<p>2.</p>  <p>Push in and turn knob.</p>	<p>3.</p>  <p>Place food on griddle, and cook to desired doneness.</p>

The griddle light will turn off when the griddle has finished preheating. The griddle light will turn on and off during use to indicate that the griddle element is maintaining the selected surface temperature.



CONTROL PANEL

When pressing any control pad function on the Electronic Oven Control, use the pad of your finger to press the desired function. Hold down the pad a few seconds, or until the desired function appears in the display.

When entering multiple functions within one setting, pause briefly between each control pad command. If a command pad is pressed several times repeatedly, the pad may briefly stop working. Wait a few seconds, and the pad should function again as normal.

OVEN DISPLAY

- When the oven is in use, this display shows the oven temperature, heat source(s) and start time.
- During Timed Cooking, this display also shows a timed countdown and the stop time (if entered).
- If “Err” appears on the display, an invalid pad was pressed. Press OFF and retry your entry.
- When the oven is not in use this display is blank, except for the clock display.

FUNCTIONS

Control Panel

Using the Start Pad

The START pad begins any oven function except the Timer, Control Lock and Sabbath Mode. If not pressed within 5 seconds after pressing a pad, “START?” will appear on the oven display as a reminder. If not pressed within 5 minutes after pressing a pad, the oven display will return to inactive mode (blank) and the programmed function will be canceled.

If a function has been started and a different function is selected, “START?” will appear in the display after 5 seconds. If the START pad is not pressed within 5 seconds, the oven display will return to the active/already started function.

Using the Off Pad

The OFF pad stops any oven function except for the Clock, Timer, and Control Lock.

Using Control Lock

The Control Lock shuts down the control panel pads to avoid unintended use of the oven(s).

The Control Lock feature may be used either when the range is in use or turned off (for example, during cleaning).

The Control Lock is preset unlocked, but can be locked.

When the control is locked, only the TIMER SET/START, TIMER OFF and OVEN LIGHT pads will function.

To Lock or Unlock Control:

Before locking, make sure the oven, the Timer and Timed Cooking are off.

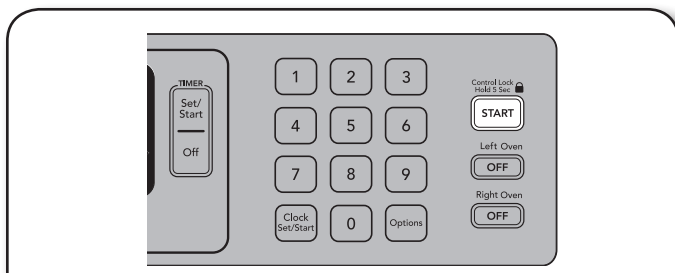

Press and hold START for 5 seconds until “CONTROL LOCKED” appears on the display. Repeat to unlock and remove “CONTROL LOCKED” from the display.

Clock

Setting the Clock

This is a 12-hour clock.

- Press CLOCK SET/START.
- Enter time of day.
- Press CLOCK SET/START.

TIMER

Setting the Timer

The Timer can be set in minutes and seconds or hours and minutes and counts down the set time. The time can be reset during the countdown by repeating the steps below.

NOTE: The Timer does not start or stop the oven.

- Press TIMER SET/START. Press again to switch from MIN/SEC and HR/MIN.
- Enter desired time.
- Press TIMER SET/START. When time reaches 0:00, 4 chimes will sound until TIMER OFF is pressed.
- Press TIMER OFF at any time to cancel Timer or stop reminder tones.



USING YOUR OVEN

OPTIONS

This manual covers different models. The oven you have purchased may have some or all of the items listed. The locations and appearances of the items shown here may not match those of your model.

Options Selection Pad

The OPTIONS selection pad allows you to access special functions within the Electronic Oven Control that allow you to customize the product to your needs. These special functions allow you to change the oven temperature between Fahrenheit and Celsius, turn the audible signals and prompts on and off, and adjust the oven calibration. The Dehydrate and Sabbath Mode are also set using the OPTIONS selection pad.

NOTE: The Sabbath mode can only be set using the Options selection pad after the mode is enabled (See “Sabbath Mode – Option 7” section.)

To Use:

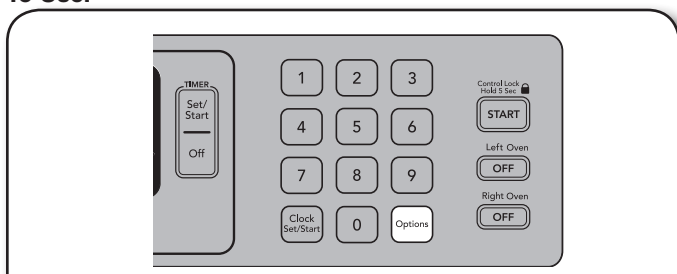

Press OPTIONS. The oven display will scroll through the 6 options, or you can press a number pad to quickly enter the desired hidden function. Each time an option is selected, the oven will toggle to the setting displayed.

OPTIONS	SPECIAL FUNCTION
1	Fahrenheit and Celsius conversion
2	Tones On/Off
3	Tones High/Low
4	Cooking Time Completion Tones On/Off
6	Oven Temperature Calibration
7	Sabbath Mode

Fahrenheit and Celsius – Option 1

Fahrenheit is the default setting, but setting may be changed to Celsius.

Tones – Options 2, 3, 4

Tones are audible signals, indicating the following:

One beep

- Function has been entered

Three beeps

- Invalid pad press

Preheat Completion Tone

- One chime indicates a preheat cycle has been completed.

Timer Completion Tones

- Four chimes sound twice when the timer reaches zero. This can occur when using the timer for functions other than cooking.

Cooking Time Completion Tones

- Three beeps indicate the end of a cooking cycle.

All Tones ON/OFF

All tones are preset to ON, but can be turned OFF.

Tone Volume High/Low

The volume is preset to HIGH but can be changed to LOW.

Cooking Time Completion Tones ON/OFF

All tones are preset to ON but can be turned OFF.

Oven Temperature Calibration – Option 6

IMPORTANT: Do not use a thermometer to measure oven temperature because opening the oven door during cycling may give incorrect readings.

The oven provides accurate temperatures; however, it may cook faster or slower than your previous oven, so the temperature calibration can be adjusted. It can be changed in Fahrenheit or Celsius.

A minus sign means the oven will be cooler by the displayed amount. The absence of a minus sign means the oven will be warmer by the displayed amount. Use the following chart as a guide.

ADJUSTMENT °F (AUTOMATIC °C CHANGE)	COOKS FOOD
30°F (15°C)	...much more
20°F (10°C)	...moderately more
10°F (5°C)	...a little more
0°F (0°C)	...default setting
-10°F (-5°C)	...a little less
-20°F (-10°C)	...moderately less
-30°F (-15°C)	...much less

To Adjust:

1.

Press 3 to increase or 6 to decrease the temperature calibration level by 10 degrees.

2.

Press START to end calibration.





Sabbath Mode

- The Sabbath Mode sets the oven(s) to remain ON in a bake setting until turned off.
- A timed Sabbath Mode can also be set to keep the oven on for only part of the Sabbath.
- When the Sabbath Mode is set, only the number and start keys will function.
- No tones will sound, and the display will not show messages or temperatures changes.
- The heat source icons will appear lit on the oven display throughout the Sabbath Mode.
- When the oven door is opened or closed, the oven light will not turn on or off and the heating elements will not turn on or off immediately.
- If a power failure occurs when the Sabbath Mode is set, the oven will remain in Sabbath Mode but will no longer be actively cooking. The "ON" indicator will no longer be illuminated. Press OFF to return to normal operating mode (non-Sabbath Mode compliant, not cooking).

To Enable:

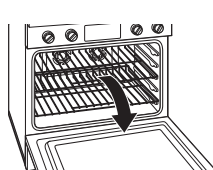
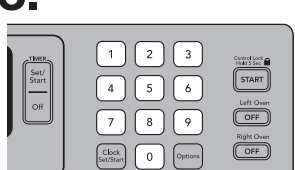
IMPORTANT: Before the Sabbath Mode can be regularly set, the oven(s) must first be enabled with a one time only setup.

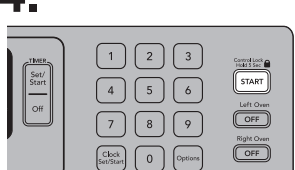
<p>1.</p>  <p>Open oven door.</p>	<p>3.</p>  <p>Press number pads 7,8,9,6 in this order.</p>
<p>2.</p>  <p>Press OFF.</p>	<p>4.</p>  <p>Press START.</p>

To Disable:

The Sabbath Mode setting capability can be disabled by repeating the previous steps. The Sabbath Mode cannot be regularly set until re-enabled.

To Set Regularly Untimed:

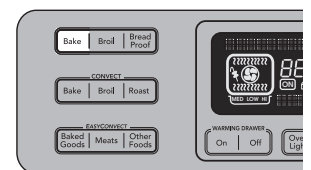
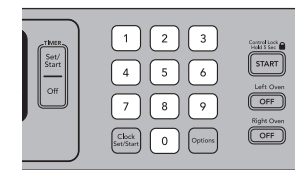
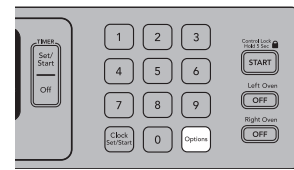
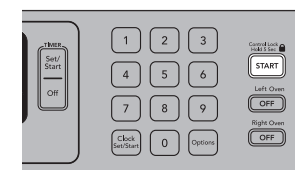
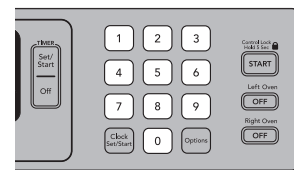
<p>1.</p>  <p>Press BAKE.</p>	
<p>2.</p>  <p>Change preset temperature, if desired.</p>	<p>4.</p>  <p>Press OPTIONS.</p>
<p>3.</p>  <p>Press START.</p>	<p>5.</p>  <p>Press number pad 7.</p>



USING YOUR OVEN

To Set Regularly Timed:

WARNING

Food Poisoning Hazard

Do not let food sit in oven more than one hour before or after cooking.

Doing so can result in food poisoning or sickness.

1.

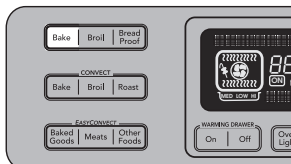

Press BAKE.

2.

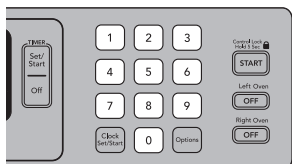

Change preset temperature, if desired.

5.



Press START.

3.

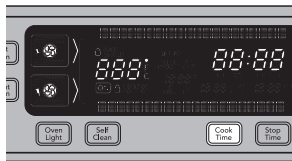

Press COOK TIME.

6.

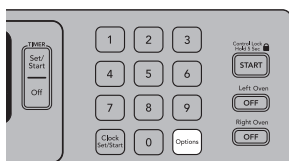

Press OPTIONS.

4.



Enter cook time.

7.

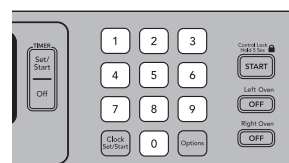

Press number pad 7.

Temperature Change

The oven temperature can be changed when the oven(s) are in the Sabbath Mode. No tones will sound, and the display will not change. The heating elements will not turn on or off for a random time, anywhere from 16 to 24 seconds. It may take up to 30 minutes for the oven to change temperature.

Number pads 1 through 0 represent temperatures.

Use the following chart as a guide.

NUMBER KEY	OVEN TEMPERATURE
1	170°F (77°C)
2	200°F (95°C)
3	225°F (107°C)
4	250°F (120°C)
5	300°F (149°C)
6	325°F (163°C)
7	350°F (177°C)
8	375°F (191°C)
9	400°F (204°C)
0	450°F (232°C)

To Change Temperature:

1.

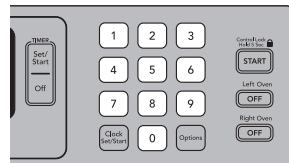

Press the number pad from the chart.

2.

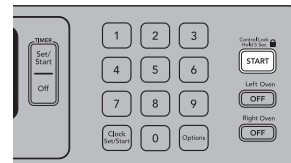

Press START.

When the stop time is reached, the oven will automatically turn off. The oven control will remain in the Sabbath Mode until the OFF button is pressed.



KNOW YOUR OVEN

- Odors and smoke are normal when the oven is used the first few times, or when it is heavily soiled.
- IMPORTANT:** The health of some birds is extremely sensitive to the fumes given off. Exposure to the fumes may result in death to certain birds. Always move birds to another closed and well-ventilated room.
- IMPORTANT:** This oven automatically adjusts for 208V operation without affecting cooking performance. Preheat times may be longer.

Aluminum Foil

- IMPORTANT:** To avoid permanent damage to the oven bottom finish, do not line the oven bottom with any type of foil or liner.
- On models with bottom oven vents, do not block or cover the vents.
- For best cooking results, do not cover rack with foil because air must be able to move freely.

Positioning Rack and Bakeware

IMPORTANT: To avoid permanent damage to the porcelain finish, do not place food or bakeware directly on the oven door or bottom.

Racks

- Position racks before turning on the oven.
- Do not position racks with bakeware on them.
- Make sure racks are level.

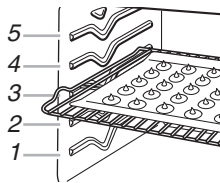

To move a rack, pull it out to the stop position, raise the front edge, then lift out. Use the following illustration and charts as a guide.

Bakeware

To cook food evenly, hot air must be able to circulate. Allow 2" (5.0 cm) of space around bakeware and oven walls. For convection cooking, allow 1" (2.5 cm) of space around bakeware and oven walls.

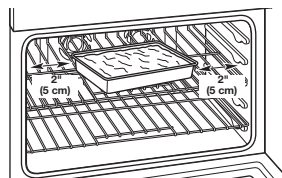

Roll-Out Extension Rack

The roll-out extension rack allows easy access to position and remove food in the oven. It can be used in rack positions 1 through 4. The roll-out extension rack will not fit in position 5.

Open Position

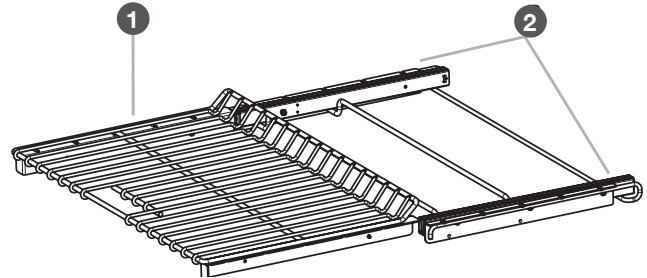

Closed and Engaged Position

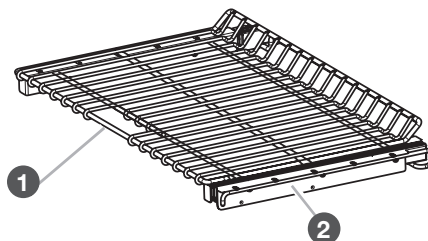

- 1 Roll-out extension rack
- 2 Sliding shelves

To Remove the Roll-Out Extension Rack:

1.

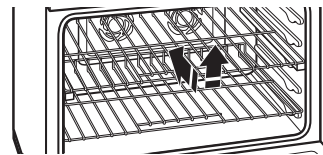

Lift up rack/shelf front and slide in.

Rack must be closed and engaged with sliding shelf. Using 2 hands, lift up on front edge of rack and sliding shelf together. Slowly push both to back wall of oven.

The front edge of the sliding shelf should sit on the rack guide located on the sides of the oven.

The front edge of the rack and the sliding shelf should be higher than the back edge.

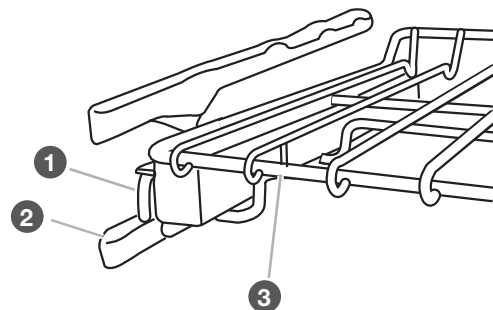

- 1 Sliding shelf
- 2 Rack guide
- 3 Roll-out extension rack



USING YOUR OVEN

2.

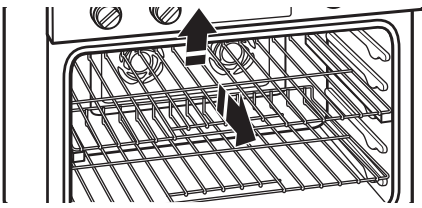

Lift up rack/shelf rear.

Using 2 hands, lift up back of rack and sliding shelf so that back and front are level on rack guide. Pull out.

To Replace the Roll-Out Extension Rack:

1.

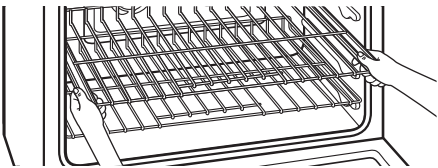

Place on rack guide.

Using 2 hands, grasp front of the closed rack and sliding shelf. Place the closed rack and sliding shelf on the rack guide.

2.

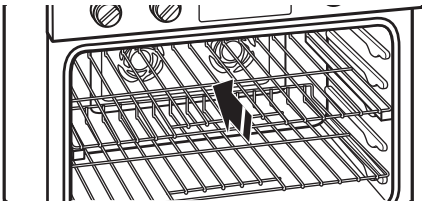

Slide in rack/shelf

Slowly push the rack and sliding shelf to the back of oven until the back edge of the sliding shelf drops.

3.

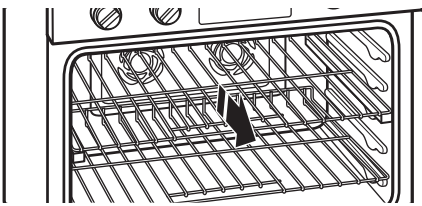

Pull rack/shelf forward

Pull the rack and sliding shelf slightly forward until the front edge drops and the sliding shelf is on the rack guide.

Know your Racks

- To avoid damage to the sliding shelves, do not place more than 25 lbs (11.4 kg) on the rack.
- Do not clean the roll-out extension rack in a dishwasher. It may remove the rack's lubricant and affect its ability to slide.
- See the "Care and Cleaning" section for more information.

Meat Thermometer

When not using the supplied temperature probe, use a meat thermometer to determine whether meat, poultry, and fish are cooked to the desired degree of doneness. The internal temperature, not appearance, should be used to determine doneness. A meat thermometer is not supplied with this appliance. Follow manufacturer's directions for using a meat thermometer.

Oven Vent

The oven vent should not be blocked or covered since it allows the release of hot air and moisture from the oven. Blocking or covering the vent will cause poor air circulation, affecting cooking and cleaning results. Do not put plastics, paper, or other items that could melt near the oven vent.

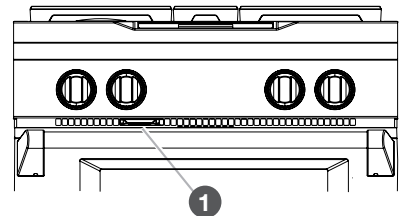

1 Oven vent

USING YOUR OVEN

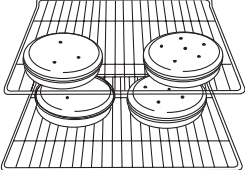

BAKED GOODS	RECOMMENDED MODE(S)	RECOMMENDED RACK POSITION(S)	TIPS
Cakes	Bake, Convection Bake	Three racks — 1, 3, 5 Two racks — 2 and 4 One rack — 3	 <p>For best results when baking cakes on 2 racks, place the cakes on the racks as shown.</p>
Cookies	Bake, Convection Bake	Three racks — 1, 3, 5 Two racks — 1 and 4, 2 and 4 (Convection Bake only) One rack — 3	

TRADITIONAL COOKING

Bake, Roast, and Broil

Set traditional cooking modes by following these steps:

1.

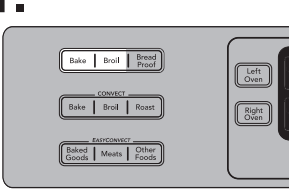

Touch desired mode.

3.

Set optional modes (Bake and Roast only).
(See “Time/Delay Cooking” section.)
(See “Temperature Probe” section.)

2.

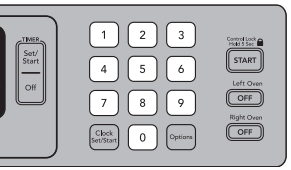

Enter desired cooking temperature.

4.

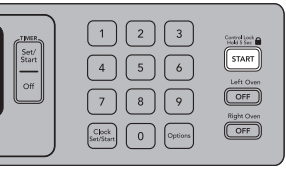

Touch START.

Baking and Roasting

The Bake/Roast Mode relies primarily on heat from the lower bake element and radiant heat from the oven cavity to produce the perfect conditions for cakes, cookies, quick breads, yeast breads, meatloaf, and baked desserts. This mode is perfect for foods that require both upper and lower browning.

Know Your Bake/Roast Mode

- During baking or roasting, the bake and broil elements will cycle on and off in intervals to maintain the oven temperature.
- If the oven door is opened during baking or roasting, the heating elements (bake, both broils, and convection fan) will turn off approximately 30 seconds after the door is opened. They will turn on again approximately 30 seconds after the door is closed.
- For baking, allow the range to preheat before placing food in the oven.
- When roasting, it is not necessary to wait for the oven to preheat before putting food in, unless recommended in the recipe.

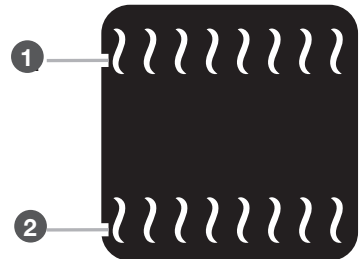

- 1 Broil elements**
- 2 Bake element**



USING YOUR OVEN

True-Broil® Reflector Full and Center Broiling

The Broil Mode uses intense heat from above to cook foods quickly and is ideal when you want rich, flavorful browning of exterior surfaces. Use for steak, chicken, pork, fish, or vegetables like onions and peppers. This mode can also brown and crisp desserts or casserole toppings.

Know your Broil Mode

- Broiling uses direct radiant heat to cook food.
- During full broiling, both the inner and outer broil elements heat. During center broiling, only the inner broil element heats. The element(s) cycle on and off in intervals to maintain the oven temperature.
- Press BROIL once for full broil or twice for center broil (right oven only).
- If the oven door is opened during broiling, the broil element will turn off in approximately 30 seconds. When the oven door is closed, the elements will come back on approximately 30 seconds later.
- For best results, use a broiler pan and grid. It is designed to drain juices and help avoid spatter and smoke.
- For proper draining, do not cover the grid with foil. The bottom of the broiler pan may be lined with aluminum foil for easier cleaning.
- Trim excess fat to reduce spattering. Slit the remaining fat on the edges to avoid curling.
- When broiling, changing the temperature allows more precise control. The lower the temperature, the slower the cooking. Thicker cuts and unevenly shaped pieces of meat, fish, and poultry may cook better at lower broiling temperatures.
- Pull out oven rack to stop position before turning or removing food. Use tongs to turn food to avoid the loss of juices. Very thin cuts of fish, poultry, or meat may not need to be turned.
- After broiling, remove the pan of food from the oven. Drippings will bake on the pan if left in the heated oven, making cleaning more difficult.

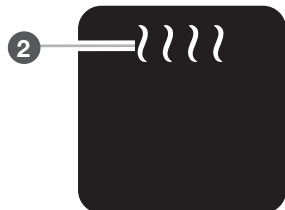
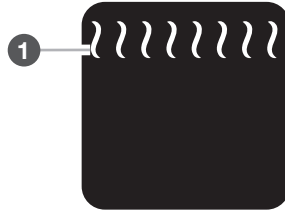

1 Full Broil
2 Center broil

- It is important not to cover foods with lids or aluminum foil so that surface areas remain exposed to the circulating air, allowing browning and crisping.
- Keep heat loss to a minimum by opening the oven door only when necessary.
- Choose cookie sheets without sides and roasting pans with lower sides to allow air to move freely around the food.
- Test baked goods for doneness a few minutes before the minimum cooking time using a method such as a toothpick.
- Use a meat thermometer or the temperature probe to determine the doneness of meats and poultry. Check the temperature of pork and poultry in 2 or 3 places.

Set convection cooking modes by following these steps:

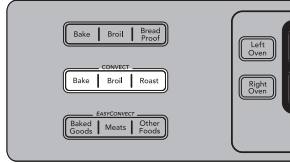
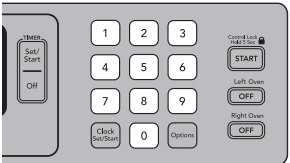
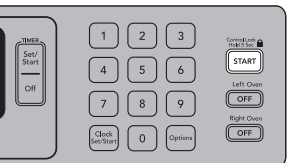
<p>1.</p>  <p>Press CONVECT BAKE, ROAST, or BROIL.</p>	<p>3.</p> <p>Set optional modes (Convection Bake and Roast only). (See "Time/Delay Cooking" section.) (See "Temperature Probe" section.)</p>
<p>2.</p>  <p>Enter desired cooking temperature.</p>	<p>4.</p>  <p>Press START.</p>

EVEN-HEAT™ TRUE CONVECTION COOKING

Convection Bake, Convection Roast, Convection Broil, and Easy Convection Conversion

Even-Heat™ true convection cooking uses a fan in the oven to circulate hot air continually. This distributes heat more evenly than the natural movement of air in a standard thermal oven. The movement of hot air helps maintain a consistent temperature throughout the oven, cooking foods more evenly, crisping surfaces while sealing in moisture and yielding crustier breads.

It is normal for the convection fan to cycle on and off during a cooking cycle.

Baked goods and casseroles can be cooked by lowering cooking temperatures 25°F (14°C). It is not necessary to reduce temperature when cooking meats and poultry. Cooking times for large turkeys and other poultry may be shorter when using the convection function.



Convection Baking

The Convection Bake mode uses an element and a fan to circulate hot air throughout the oven, resulting in baking 10–20% faster than traditional baking. Convection baking can be used for most baked goods, but it is exceptional for baking cookies, biscuits, pies, pasta dishes, casseroles, and frozen or convenience foods.

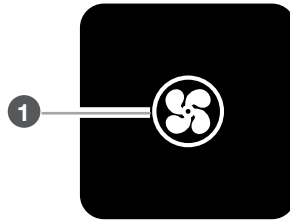

1 Convection element (hidden) and fan

Know Your Convection Bake Mode

- A convection element is hidden in the rear panel of the oven cavity, and assisted by the convection fan, provides balanced, efficient heating.
- Convection baking can be used for baking delicate cakes and pastries, as well as foods on multiple racks. It is helpful to stagger items on the racks to allow a more even flow of heat. If the oven is full, extra cooking time may be needed.
- When cooking an oven meal with several different types of foods, be sure to select recipes that require similar temperatures. Cookware should sit in the oven with at least 1" (2.5 cm) of space between the cookware and the sides of the oven.
- During convection baking preheat, the convection element, broil element, and the CleanBake™ element all heat the oven cavity. After preheat, the convection element, the CleanBake™ element, and the fan will cycle on and off in intervals to maintain oven temperature.
- If the oven door is opened during convection baking, the fan turns off immediately when the door is opened and turns on immediately when the door is closed. Convection, Bake and Broil (only during preheating) elements will turn off approximately 30 seconds after the door is opened. They will turn on again approximately 30 seconds after the door is closed.
- Reduce recipe temperature 25°F (14°C). The cook time may need to be reduced also.

Convection Roasting

The Convection Roast Mode uses multiple elements and a fan to stream heated air throughout the cavity. The circulating air caramelizes food surfaces for enhanced flavor while maintaining moist and tender interiors. Convection Roast is perfect for roasting meats, poultry, firm-fleshed fish, and vegetables. The consistent and even heat distribution speeds cooking up to 25% compared to traditional roasting. The recipe temperature does not need to be reduced for this mode.

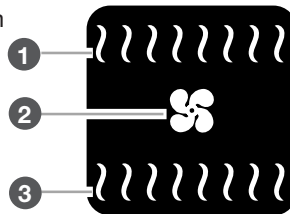

1 Broil heat
2 Convection fan
3 Bake heat

Know Your Convection Roast Mode

- If the oven door is opened during convection roasting, the fan turns off immediately when the door is opened and turns on immediately when the door is closed. Broil and bake elements will turn off approximately 30 seconds after the door is opened. They will turn on again approximately 30 seconds after the door is closed.
- It is not necessary to reduce oven temperature when roasting with convection. Roasting time may be shorter for poultry.
- For best results, use a broiler pan, grid, and roasting rack designed to drain juices and help avoid spatter and smoke.

Before Using Convection Roast:

- It is not necessary to wait for the oven to preheat before putting in food, unless recommended in the recipe.
- Use a roasting rack on top of the broiler pan and grid. This holds the food above the grid and allows air to circulate completely around all surfaces.

Convection Broiling

The Convection Broil Mode uses multiple elements and a fan to stream heated air throughout the cavity.

Convection broil shortens broiling times by removing the insulating air from around the food, allowing the moving hot air to cook the food faster. Thick, tender cuts of meat, fish, and poultry benefit from this cooking method.

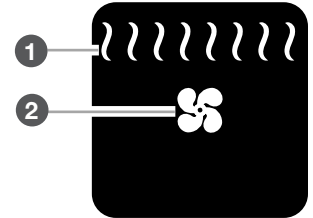

1 Broil heat
2 Convection fan

Know Your Convection Broil Mode

- During convection broiling, the broil elements will cycle on and off in intervals to maintain oven temperature, while the fan constantly circulates the hot air.
- The temperature is preset at 325°F (163°C), but can be changed to a different temperature. Cooking times will vary depending on the rack position and temperature and may need to be adjusted.
- If the oven door is opened during convection broiling, the fan turns off immediately when door is opened and turns on again immediately when door is closed. Broil elements will turn off approximately 30 seconds after the door is opened. They will turn on again approximately 30 seconds after the door is closed.

Using Convection Broil:

- Before convection broiling, see "True-Broil® Reflector Full and Center Broiling" section for general broiling guidelines.
- Position food on the unheated grid on the broiler pan, then place it in the center of the oven rack with the longest side parallel to the door.



USING YOUR OVEN

EasyConvect™ Conversion

Convection temperatures and times can differ from those of standard cooking. Depending upon the selected category, EasyConvect™ conversion will automatically reduce standard recipe temperatures and/or times for convection cooking.

Foods are grouped into 3 general categories. Choose the category most appropriate for the food to be cooked. To ensure optimal cooking results, the oven will prompt a food check at the end of a non-delayed cook time.

Use the following chart as a guide:

SETTING	COOKS FOOD
Baked Goods	Biscuits, Breads: quick and yeast Cakes and Cookies Casseroles: including frozen entrées and soufflés Fish
Meats	Baked potatoes, Chicken: whole and pieces Meat Loaf, Roasts: pork, beef, and ham (Turkey and large poultry are not included because their cook times vary.)
Other Foods	Convenience foods: french fries, nuggets, fish sticks, pizza Pies: fruit and custard
Biscuits & Bread	Biscuits, Breads: Quick and Yeast

To Use EasyConvect™ Conversion:

When using convection temperature conversion for BAKED GOODS and OTHER FOODS, allow the oven to preheat before placing food in the oven. When using convection for meats, preheating is not necessary.

1.

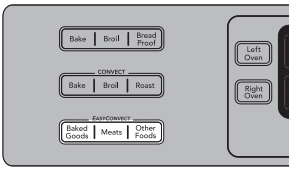

Press BAKED GOODS, MEATS, or OTHER FOODS.

3.

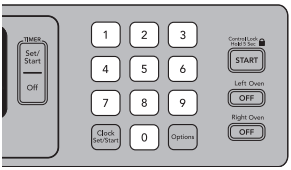

Enter standard cook time.

2.

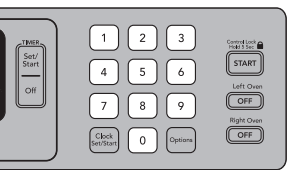

Enter standard temperature.

4.

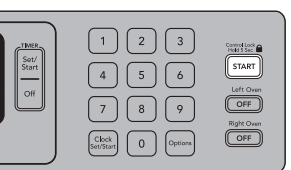

Press START, and then place food in the oven.

SPECIAL MODES

Proofing Bread

Proofing bread prepares dough for baking by activating the yeast. Follow recipe direction as a guide.

To Proof:

1.

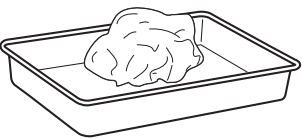

Before first proofing, place dough in a lightly greased bowl and cover loosely with wax paper coated with shortening. Close door.

2.

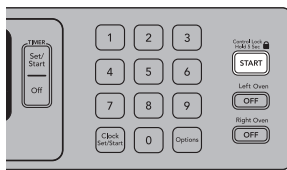

Press START.

3.

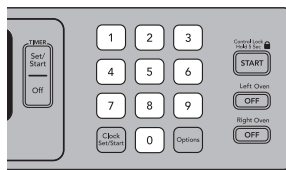

Press BREAD PROOF.

NOTE: The Proof cycle will start even if the oven temperature is over 300°F (149°C). You cannot change the temperature under Bread Proofing.

Before second proofing, shape dough, place in baking pan(s) and cover loosely with plastic wrap coated with cooking spray. Follow same placement and control steps above. Before baking, remove plastic wrap.

Temperature Probe

The temperature probe accurately measures the internal temperature of meat, poultry and casseroles and should be used in determining the doneness of food. It is available on most cycles including: Bake, Convection Bake, Convection Roast, and EasyConvect™ Conversion.

Know Your Temperature Probe

- Always unplug and remove the temperature probe from the oven when removing food.
- When using the probe, the Cook Time function may not be used.



Before Using Temperature Probe:

- Remove any racks above the food that are not in use.
- Insert the probe into the food item. For meats, the probe tip should be located in the center of the thickest part of the meat and not into the fat or touching a bone.
- Place food in oven and connect the temperature probe to the jack.
- Keep probe as far away from heat source as possible. Close oven door.

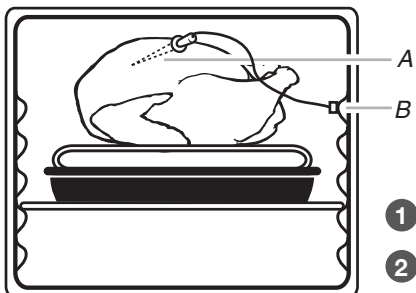

- 1 Temperature probe
- 2 Temperature probe jack

To Use Temperature Probe:

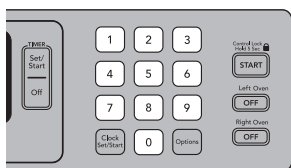

Enter desired probe temperature before selecting a cooking mode. The probe temperature is the desired temperature of the food when it is done.

After Cooking:

Unplug and remove the probe when removing food.

Timed/Delay Cooking

WARNING

Food Poisoning Hazard

Do not let food sit in oven more than one hour before or after cooking.

Doing so can result in food poisoning or sickness.

Timed Cooking allows the oven(s) to cook for a set length of time. Delay Cooking allows the oven(s) to be set to turn on at a certain time of day. Delay start should not be used for food such as breads and cakes because they may not bake properly.

Timed Cooking is available on most cycles including: Bake, Convection Bake, Convection Roast, EasyConvection™ Conversion, Bread Proof, and Keep Warm.

Delay Cooking is available on the Bake, Convection Bake, and Convection Roast cycles.

NOTE: For best cooking results, when the temperature probe is being used, the Cook Time function cannot be used.

To Set a Cooking Time:

1.

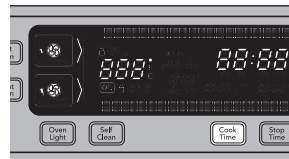

Press COOK TIME.

2.

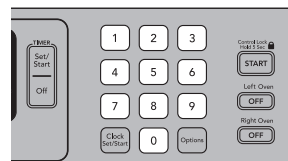

Enter desired cook time.

3.

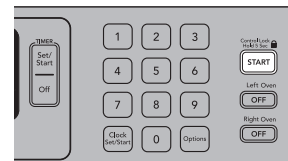

Press START.

To Set a Delay Cooking Time:

Before setting, make sure the clock is set to the correct time of day. See "Clock" section.

1.

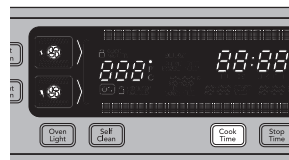

Press COOK TIME.

2.

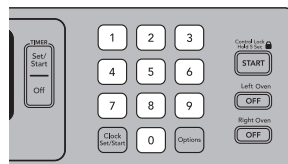

Enter desired cook time.

4.

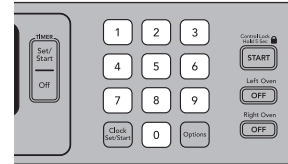

Enter desired stop time. The start time is automatically calculated. When the start time is reached, the oven will automatically turn on. When the stop time is reached, the oven will shut off automatically.

3.

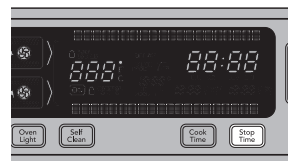

Press STOP TIME.

5.

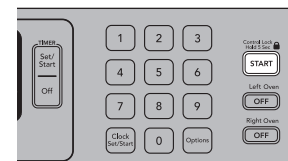

Press START.



CARE AND CLEANING

COOKTOP SURFACE

After Each Use:

1.



Wipe off cooktop, grates, and caps.

2.

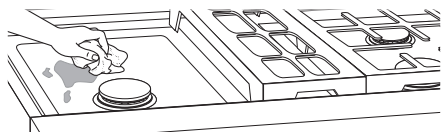

Clean food spills.

To preserve the finish, clean food spills containing acids, such as vinegar and tomato, as soon as the entire appliance is cool.

SEALED SURFACE BURNERS

1.

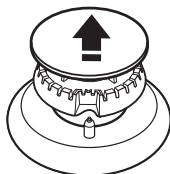

Remove burner cap and base.

2.

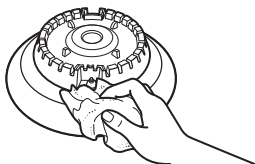

Wipe off cooktop, grates, and caps.

3.

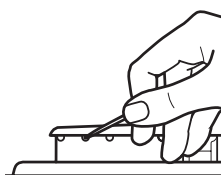

Clean clogged burner ports.

Use a straight pin. Do not enlarge or distort the port. Do not use a wooden toothpick. If the burner needs to be adjusted, contact a trained repair specialist.

4. Replace burner cap.

Dual-Flame Burner

1

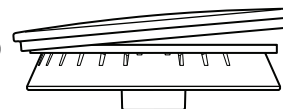

1 Incorrect
2 Correct

2

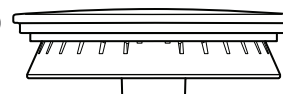

Medium Burner

1

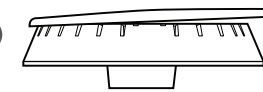

1 Incorrect
2 Correct

2

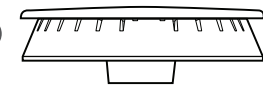

Simmer/Melt Burner

1

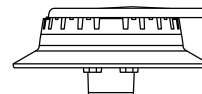

1 Incorrect
2 Correct

2

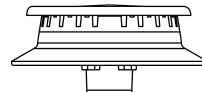

Make sure alignment pins are properly aligned with burner cap.

5.

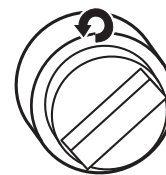

Turn ON burner.

If the burner does not light, check cap alignment. If the burner still does not light, do not service the sealed burner yourself. Contact a trained repair specialist.



PORCELAIN-COATED GRATES AND CAPS

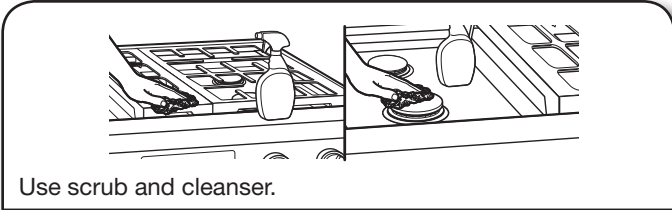

Use scrub and cleanser.

Clean with a nonabrasive nylon scrub pad and mildly abrasive cleanser.

Know Your Grates and Caps

- Food spills containing acids, such as vinegar and tomato, should be cleaned as soon as the cooktop, grates, and caps are cool. These spills may affect the finish.
- To avoid chipping, do not bang grates and caps against each other or hard surfaces such as cast iron cookware.
- Do not reassemble caps on burners while wet.
- Do not clean in the Self-Cleaning cycle.
- Do not clean in dishwasher.

GRILL

To Remove:

Before removing or replacing grill, make sure the control knobs are turned to OFF. Allow the grill to cool completely before handling.

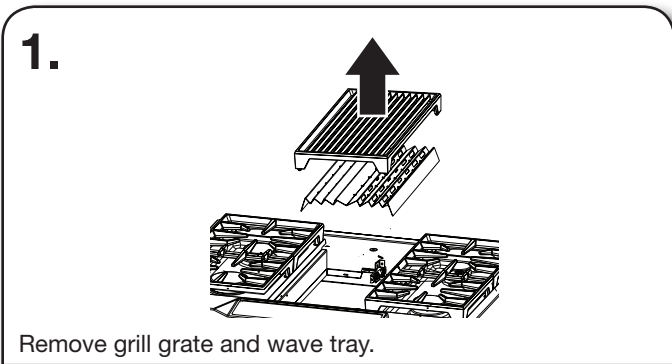

Remove grill grate and wave tray.

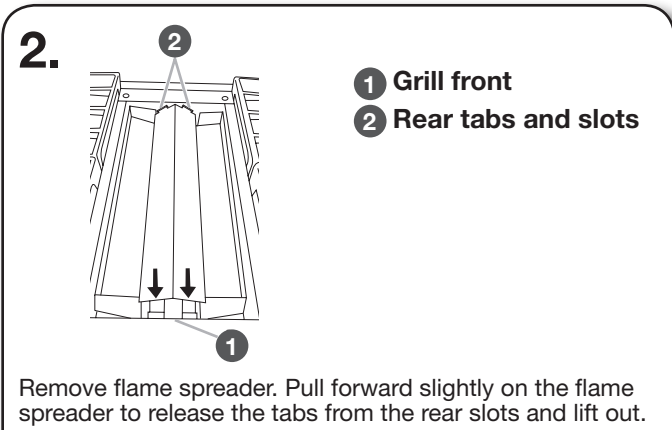

Remove flame spreader. Pull forward slightly on the flame spreader to release the tabs from the rear slots and lift out.

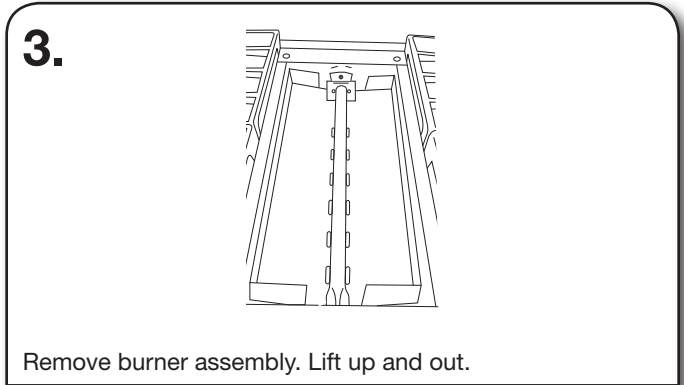

Remove burner assembly. Lift up and out.

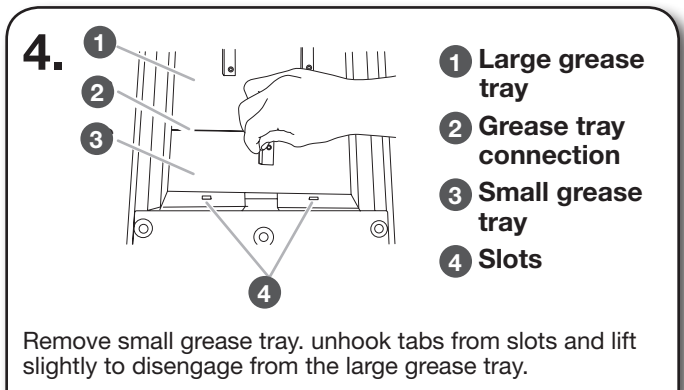

Remove small grease tray. unhook tabs from slots and lift slightly to disengage from the large grease tray.

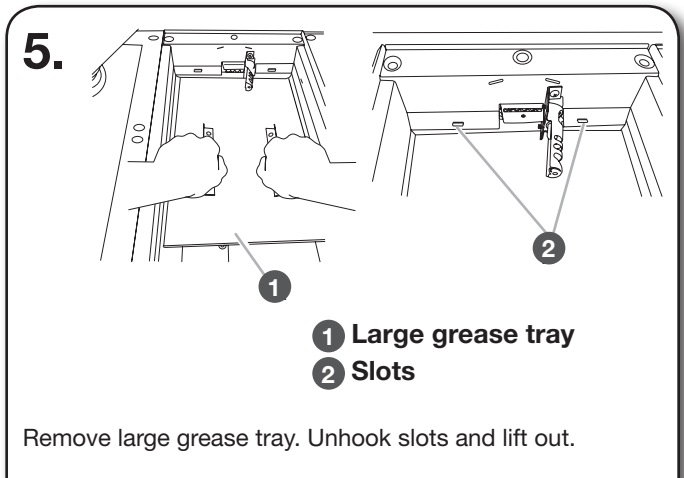

Remove large grease tray. Unhook slots and lift out.

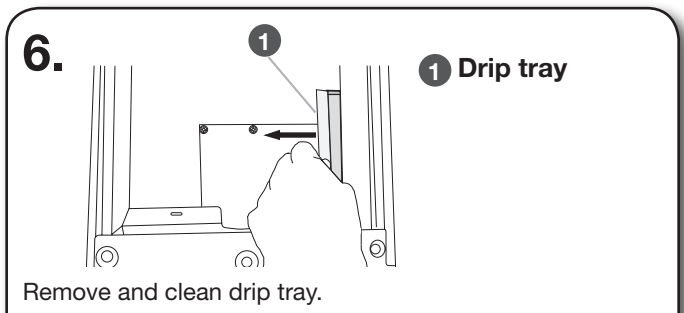

Remove and clean drip tray.



CARE AND CLEANING

To Clean:

Do not use oven cleaners, metal brushes, abrasive scouring pads or other scrubbers made to clean outdoor grills.

Grate:

- Do not clean grill grate in dishwasher.
- Do not clean in a self-cleaning oven.

1.

Scrub with brush while grate is still war. Use a soft-bristle brush. Oven mitts may be worn while cleaning.

2.

Soak in warm, soapy water for 30 minutes. After soaking, scrub with nonabrasive pad.

Wave Tray and Wave Plate:

1.

Soak in warm, soapy water to loosen soil. After soaking, scrub with non-abrasive pad. Oven cleaner may be used.

Burner Assembly:

- Do not soak in water.

1.

Wipe with warm, soapy water or non-abrasive cleanser. Use damp cloth or non-abrasive pad.

Grease Trays and Drip Tray:

- Allow cooktop to cool before cleaning.

1.

Wipe with warm, soapy water or non-abrasive cleanser. Use damp cloth or non-abrasive pad.

Module Basine:

1.

Wipe with warm, soapy water or non-abrasive cleanser. Use damp cloth or non-abrasive pad.

2.

For heavy soil, soak with paper towels. Soak paper towels in household cleanser and lay them on the soil for at least 30 minutes. After soaking, scrub with a nonabrasive pad.

To Replace

1.

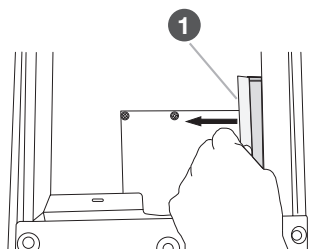

1 Drip tray

Replace drip tray. Slide drip tray into opening on the right front side of the grill basin. Follow the guides to ensure correct placement.

2.

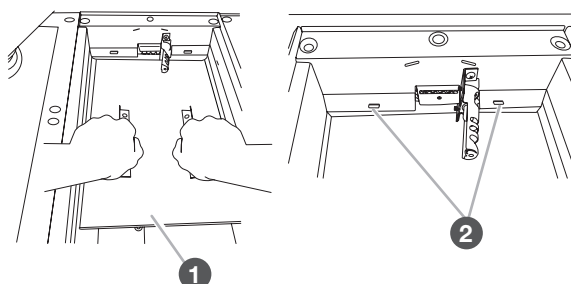

1 Large grease tray

2 Slots

Replace large grease tray. Insert the large grease tray all the way under the back edge of the grill basin and hook it into the slots.

3.

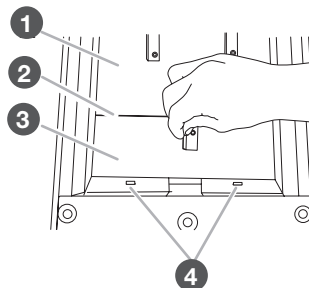

1 Large grease tray

2 Grease tray connection

3 Small grease tray

4 Slots

Replace small grease tray. Insert the small grease tray all the way under the front of the grill basin and hook it into the slots.

When the 2 grease trays are installed properly, the small grease tray will hook over the large grease tray.



4. **1 Front opening**

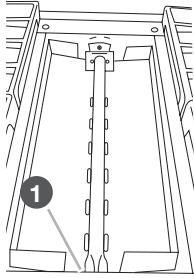

Replace burner assembly. Insert the orifice tube on the front of the burner assembly into the opening at the front of the grill basin and set into place.

5. **1 Grill front** **2 Rear tabs and slots**

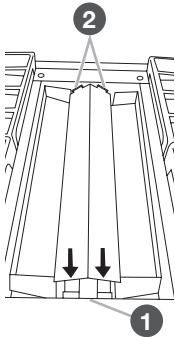

Replace flame spreader. Insert front tabs of the flame spreader into slots at the front of the grill basin; then insert rear tabs into the rear slots.

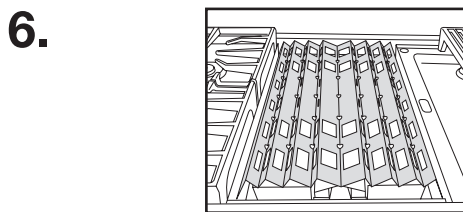

Place wave tray on top of flame spreader.

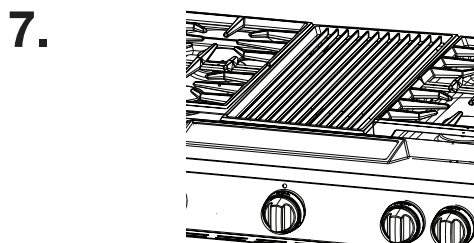

Place grill grate into position.

GRIDDLE

Tips:

- Prior to cleaning the griddle make sure that all cooktop burners have been turned off and the oven controls have been locked.
- For best results, clean the griddle shortly after removing the food.

Do Not Use:

- Soap
- Abrasive materials
- Cleaning materials, including stainless steel cleaner

After Each Use:

1. Heat for 10 to 15 minutes at 300°F.

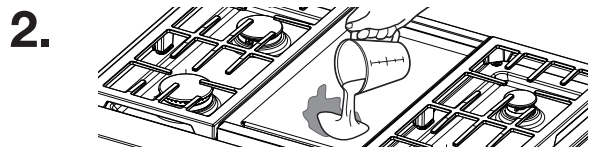

Pour water on soiled area.

Using a measuring cup, pour up to 1 cup tap water over the soiled area starting at the back allowing the water to run toward the drip tray in the front. Allow the water to bubble on the griddle for 3–4 seconds.

Use a pad holder or wooden spoon with non-scratch pad. Use pressure on soiled areas. Repeat if needed for heavy soils.



Scrape residue into drip tray.

Use a pad holder or wooden spoon with non-scratch pad. Use pressure on soiled areas. Repeat if needed for heavy soils.



CARE AND CLEANING

4.

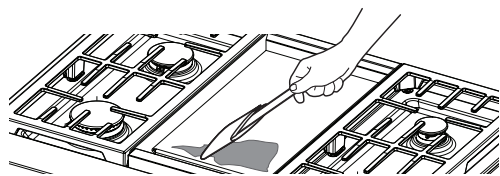

Remove remaining residue.

Fold a damp towel and with the pad holder or wooden spoon, go over the griddle to remove remaining residue.

5. Turn off griddle and let cool.

6.

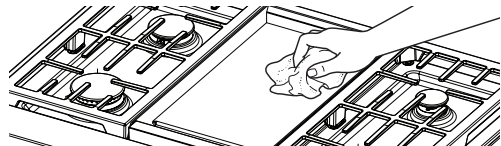

Wipe off griddle.

Once cool, wipe the griddle with a clean, damp terry cloth towel. Then buff with a microfiber cloth. If streaking, rainbowing, or ghosting occur use a mixture of 1 part white vinegar to 2 parts water on a towel to wipe the griddle.

7.

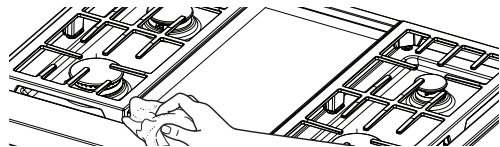

Remove, empty, and clean drip tray.

Clean the drip tray with warm soapy water. Wipe the area under the drip tray clean. Once dry, put the drip tray back in position.

COOKTOP CONTROLS

1.

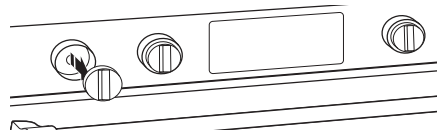

Remove knobs.

Pull the knobs straight away from the control panel to remove.

2.

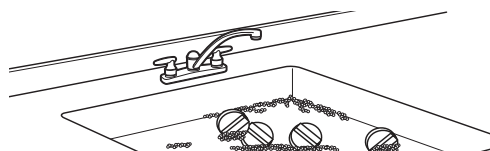

Clean with warm, soapy water.

Know Your Cooktop Controls

- To avoid damage to the cooktop controls, do not use steel wool, abrasive cleansers or oven cleaner.
- To avoid damage, do not soak knobs.
- When replacing knobs, make sure knobs are in the Off position.
- Do not remove seals under knobs.
- When replacing knobs after cleaning either the surface burner controls or the griddle module control, make sure the knobs are replaced to the correct location. The power burner knobs have power settings and the griddle knob has temperature settings. All other knobs have Hi, Med, Lo settings only.

STAINLESS STEEL

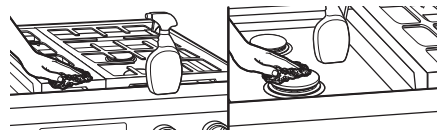

Use cleaner or wipes.

Use affresh® Stainless Steel Cleaner or affresh® Stainless Steel Cleaning Wipes (not included). Rub in direction of grain to avoid possible damage to the steel surface.

Do not use:

- Soap-filled scouring pads
- Abrasive cleaners
- Cooktop Polishing Creme
- Steel-wool pads
- Gritty washcloths
- Abrasive paper towels



CONTROL PANEL

1.

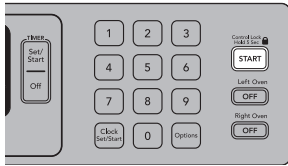

Press and hold START for 5 seconds until “CONTROL LOCK” appears on the display.

Locking buttons avoids press screen activation during cleaning.

2.

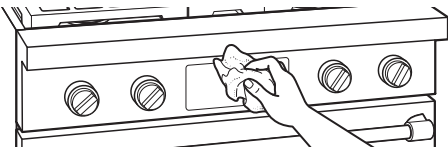

Apply cleaner.

Apply glass cleaner to soft cloth or sponge, not directly on panel, or use affresh® Kitchen and Appliance Cleaner (not included).

Do not use:

- Abrasive cleaners
- Steel-wool pads
- Gritty washcloths
- Abrasive paper towels
- When replacing knobs after cleaning either the surface burner controls or the griddle module control, make sure the knobs are replaced to the correct location. The power burner knobs have power settings and the griddle knob has temperature settings. All other knobs have Hi, Med, Lo settings only.

DOOR EXTERIOR

Apply cleaner.

Apply glass cleaner to soft cloth or sponge, not directly on panel, or use affresh® Kitchen and Appliance Cleaner (not included).

DOOR INTERIOR

1.



Wipe away any deposits.

Use a damp sponge.

2.

Use Self-Cleaning cycle (See “Self-Cleaning the oven” section).

OVEN RACKS

1.

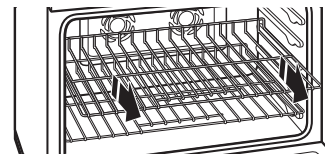

Empty out oven and remove racks.

Remove broiler pan, grid, cookware and bakeware and, on some models, the temperature probe from the oven.

IMPORTANT: Remove racks before the Self-Cleaning cycle to avoid discoloring and difficulty sliding.

2.

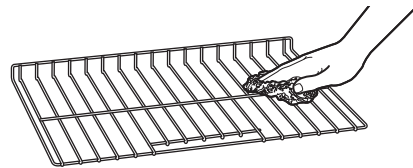

Use steel-wool pad.

OVEN CAVITY

- Do not use oven cleaners.
- Food spills should be cleaned when oven cools. At high temperatures, foods react with porcelain and staining, etching, pitting, or faint white spots can result.



CARE AND CLEANING

SELF-CLEANING THE OVEN

⚠ WARNING



Burn Hazard

Do not touch the oven during the Self-Cleaning cycle.

Keep children away from oven during Self-Cleaning cycle.

Failure to follow these instructions can result in burns.

IMPORTANT:

- The health of some birds is extremely sensitive to the fumes given off during the Self-Cleaning cycle. Exposure to the fumes may result in death to certain birds. Always move birds to another closed and well-ventilated room.
- Self-clean the oven before it becomes heavily soiled. Heavy soil results in longer cleaning and more smoke.
- Keep the kitchen well-ventilated during the Self-Cleaning cycle to help get rid of heat, odors, and smoke.
- Do not block the oven vent(s) during the Self-Cleaning cycle. Air must be able to move freely. See the "Oven Vent" section in the "Know Your Oven" section.
- Do not clean, rub, damage, or move the oven door gasket. The door gasket is essential for a good seal.

Prepare Oven:

1.

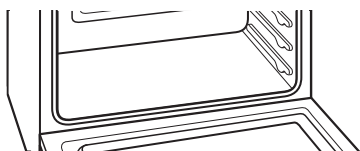

Empty out oven and remove racks.

Remove broiler pan, grid, cookware and bakeware and, on some models, the temperature probe from the oven.

IMPORTANT: Remove racks before the Self-Cleaning cycle to avoid discoloring and difficulty sliding.

2.

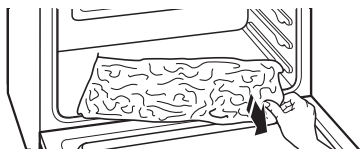

Remove any foil from oven.

Foil may burn or melt, damaging the oven.

3.

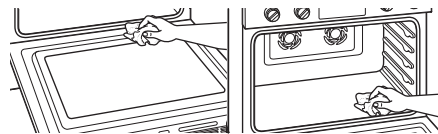

Hand clean.

With a damp cloth, hand clean the inside door edge and 1½" (3.8 cm) of the area around the inside oven cavity frame. Be certain not to move or bend the gasket. This area does not get hot enough during self-cleaning to remove soil. Do not let water, cleaner, etc., enter slots on doorframe.

4.

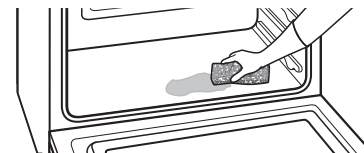

Wipe out loose soil.

Wiping out soil reduces smoke and avoids damage. At high temperatures, foods react with porcelain. Staining, etching, pitting, or faint white spots can result. This will not affect cooking performance.

Prepare Cooktop:



Remove plastic items.

Plastic items may melt.

How the Cycle Works

IMPORTANT:

- The heating and cooling of porcelain on steel in the oven may result in discoloring, loss of gloss, hairline cracks, and popping sounds.
- The Self-Cleaning cycle uses very high temperatures, burning soil to a powdery ash.
- The oven is preset for a 5 hour clean cycle; however, the time can be changed.

Use the following chart as a guide to determine the desired cleaning level:

CLEANING LEVEL	TOTAL CLEANING TIME (includes a 30 minute cool down time)
1 (Quick)	3 hours 30 minutes
2	3 hours 45 minutes
3 (Regular)	4 hours
4	4 hours 15 minutes
5 (Maxi)	4 hours 30 minutes



Once the oven has completely cooled:

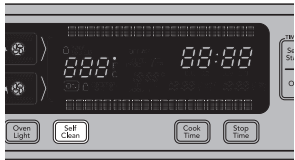

- Remove ash with a damp cloth.
- If soil remains after wiping, that means the length of the clean cycle was not long enough for the amount of soil in the oven. Repeat the self-clean cycle if desired, or the soil will be removed during the next clean cycle.
- To avoid breaking the glass, do not apply a cool damp cloth to the inner door glass before it has completely cooled.
- The oven lights will not light during the Self-Cleaning cycle.

To Self-Clean:

1.	2.
 <p>Press SELF CLEAN.</p>	<p>Select cleaning level. To set a cleaning level other than 4 hours, press SELF CLEAN until the desired time is reached.</p>

To Delay Start (optional):

Before delay starting Self-Clean, make sure the clock is set to the correct time of day. See "Clock" section.

3.	5.
 <p>Press STOP TIME.</p>	 <p>Press START.</p>
4.	6.
 <p>Enter desired stop time.</p>	<p>Press any button or open door to clear the oven display.</p>

To Stop Self-Clean any time:

 <p>Press OFF.</p>

If the oven temperature is too high, the door will remain locked. It will not unlock until the oven cools.

OVEN LIGHTS

The oven lights are 120-volt, 25-watt maximum halogen bulbs. They will come on when the oven door is opened.

On 48" (121.9 cm) ranges, both the left and right oven lights turn on or off when OVEN LIGHT is touched. The oven lights will not work during the Self-Cleaning cycle. When the oven door is closed, touch OVEN LIGHT to turn light on or off.

To Replace:

Before replacing the bulb, make sure the oven is OFF and cool.

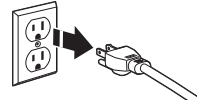
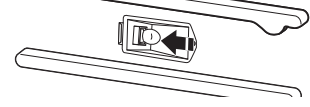
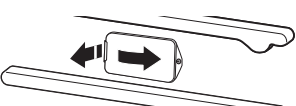
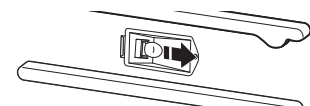
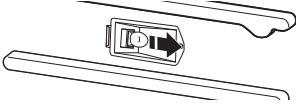
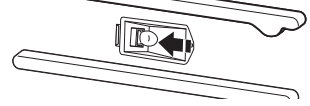
1.	4.
 <p>Disconnect power.</p>	 <p>Use a tissue or wear cotton gloves to handle the bulb. To avoid damage or decreasing the life of the new bulb, do not touch bulb with bare fingers.</p>
2.	5.
 <p>Remove glass light cover. Grasp the front edge and pull away from the oven.</p>	 <p>Replace bulb cover. Snap bulb cover back into wall.</p>
3.	6.
 <p>Remove bulb from socket.</p>	 <p>Reconnect power.</p>



TROUBLESHOOTING

First try the solutions suggested here. If you need further assistance or more recommendations that may help you avoid a service call, refer to the warranty page in this manual and scan the code there with your mobile device, or visit <https://kitchenaid.com>. In Canada, visit <http://www.kitchenaid.ca>.

If you experience	Possible causes	Solution
Nothing will operate	A household fuse has blown or a circuit breaker has tripped.	Replace the fuse or reset the circuit breaker. If the problem continues, call an electrician.
Surface burners will not operate	This is the first time the surface burners have been used.	Turn on any one of the surface burner knobs to release air from the gas lines.
	The control knob is not set correctly.	Push in knob before turning to a setting.
	The burner ports are clogged.	Clean clogged burner ports with a straight pin.
Surface burner flames are uneven, yellow, and/or noisy	The burner ports are clogged.	Clean clogged burner ports with a straight pin.
	On models with caps, the burner caps are not positioned properly.	Make sure alignment pins are properly aligned with the burner cap.
	Propane gas is being used.	The range may have been converted improperly. Contact a trained repair specialist.
Surface burner makes popping noises	The burner is wet.	Let it dry.
Burner sparks but does not light	There is continuous sparking, but the burner does not light.	Discontinue use of the surface burner and contact a service technician.
Excessive heat around cookware on cooktop	The cookware is not the proper size.	Use cookware about the same size as the surface cooking area, element, or surface burner. Cookware should not extend more than ½" (1.3 cm) outside the cooking area.
Cooktop cooking results not what expected	The proper cookware is not being used.	Use medium-to-heavy cookware made of the material that cooks food the way you want. The best cookware should have a flat bottom, straight sides, and a well-fitting lid.
	The control knob is not set to the proper heat level.	Set the Cooktop Control to HI, MED, or LO, depending upon the type of cooking you want to do.
	The range is not level.	The range must be level for the griddle to operate properly. See the Installation Instructions for leveling instructions.
Oven will not operate	This is the first time the oven has been used.	Turn on any one of the surface burner knobs to release air from the gas lines.
	The electronic oven control is not set correctly.	Make sure you have followed the instructions for the function you want to perform.
	A delay start has been set.	This will cause the oven to start at a later time.
	The Control Lock is set.	All the buttons will be locked. Slide the bar up on the main screen to unlock the button/screen.
	The Sabbath Mode is set.	This mode allows oven operation in keeping with the Jewish Sabbath. When set, only the number and start keys will function.
Oven temperature too high or too low	The oven temperature calibration needs adjustment.	Select the temperature offset up to +35°F.
Display shows messages	The display is showing a letter followed by a number.	Clear the display. If a letter followed by a number reappears, call for service.



First try the solutions suggested here. If you need further assistance or more recommendations that may help you avoid a service call, refer to the warranty page in this manual and scan the code there with your mobile device, or visit <https://kitchenaid.com>. In Canada, visit <http://www.kitchenaid.ca>.

If you experience	Possible causes	Solution
Self-Cleaning cycle will not operate	The oven door is open.	Close the oven door all the way.
	The function has not been entered.	Make sure you have properly followed the Self-Cleaning Cycle instructions.
	On some models, a delay start Self-Clean cycle has been set.	This will cause the oven to start the Self-Clean cycle at a later time.
	A delay start has been set.	This will prevent the oven from starting any function until the delay start time is reached or has been canceled.
	On 48" (121.9 cm) ranges, one oven is self-cleaning.	When one oven is self-cleaning, the other oven cannot be set to self-clean.
Oven cooking results not what expected	The proper temperature is not set.	Double-check the recipe in a reliable cookbook.
	The proper oven temperature calibration is not set.	Select the temperature offset up to +35°F to increase or decrease the temperature as desired.
	The oven was not preheated.	If the proper steps are followed when setting the desired function, the oven will preheat before cooking.
	The proper bakeware is not being used.	Make sure the bakeware used is appropriate for the food being cooked.
	The racks are not positioned properly.	Place racks so there is adequate space above each food item.
	There is not proper air circulation around bakeware.	Allow 2" (5.0 cm) of space around bakeware and oven walls.
	The batter is not evenly distributed in the pan.	Check that batter is level in the pan.
	The proper length of time is not being used.	Adjust cooking time.
	The oven door has been opened while cooking.	Oven peeking releases oven heat and can result in longer cooking times.
	Baked items are too brown on the bottom.	Move rack to higher position in the oven.
	Pie crust edges are browning early.	Use aluminum foil to cover the edge of the crust and/or reduce baking temperature.



ASSISTANCE OR SERVICE

Before calling for assistance or service, please check “Troubleshooting.” It may save you the cost of a service call. If you still need help, follow the instructions below. When calling, please know the purchase date and the complete model and serial number of your appliance. This information will help us to better respond to your request.

If you need replacement parts

If you need to order replacement parts, we recommend that you use only factory specified parts. These factory specified parts will fit right and work right because they are made with the same precision used to build every new KitchenAid® appliance.

To locate factory specified parts in your area, call us or your nearest KitchenAid designated service center.

IN THE U.S.A.

Call the KitchenAid Customer eXperience Center toll free:
1-800-422-1230.

Our consultants provide assistance with:

- Features and specifications on our full line of appliances.
 - Installation information.
 - Use and maintenance procedures.
 - Accessory and repair parts sales.
 - Specialized customer assistance (Spanish speaking, hearing impaired, limited vision, etc.).
 - Referrals to local dealers, repair parts distributors and service companies. KitchenAid designated service technicians are trained to fulfill the product warranty and provide after-warranty service anywhere in the United States.
- To locate the KitchenAid designated service company in your area, you can also look in your telephone directory Yellow Pages.

For further assistance

If you need further assistance, you can write to KitchenAid with any questions or concerns at:

KitchenAid Brand Home Appliances
Customer eXperience Center
553 Benson Road
Benton Harbor, MI 49022-2692

Please include a daytime phone number in your correspondence.

IN CANADA

Call the KitchenAid Customer eXperience Centre toll free:
1-800-807-6777.

Our consultants provide assistance with:

- Features and specifications on our full line of appliances.
- Use and maintenance procedures.
- Accessory and repair parts sales.
- Referrals to local dealers, repair parts distributors and service companies. KitchenAid Canada designated service technicians are trained to fulfill the product warranty and provide after-warranty service anywhere in Canada.

For further assistance

If you need further assistance, you can write to KitchenAid Canada with any questions or concerns at:

Customer eXperience Centre
KitchenAid Canada
200 - 6750 Century Ave.
Mississauga, Ontario L5N 0B7

Please include a daytime phone number in your correspondence.



ACCESSORIES

To order accessories, call the KitchenAid Customer eXperience Center toll free at **1-800-422-1230** and follow the menu prompts. Or visit our website at **www.kitchenaid.com** and click on “Shopping Options.” Go to “Replacement Parts & Accessories” and click on “applianceaccessories.com.” Portable appliances, bakeware, cookware, gadgets, and textiles are also available.

In Canada, call the KitchenAid Customer eXperience Center toll free at **1-800-807-6777** and follow the menu prompts. Or visit our website at **www.kitchenaid.ca** and click on “Shopping Options.” Go to “Replacement Parts & Accessories” and click on “applianceaccessories.ca.” Portable appliances, bakeware, cookware, gadgets, and textiles are also available.

Or see the “Accessories” brochure to order.

affresh® Stainless Steel Cleaner
(stainless steel models)

affresh® Stainless Steel Cleaning Wipes
(stainless steel models)

affresh® Cooktop Cleaner

Cooktop Protectant

Gas Grate/Drip Pan Cleaner

affresh® Kitchen and Appliance Cleaner
Griddle

Grill and Griddle Cover

Wok Ring

KitchenAid® Premium Broil Pan and Roasting Rack

SatinGlide™ Roll-Out Extension Rack

KitchenAid® Replacement Water Filter

KITCHENAID® DUAL FUEL RANGE LIMITED WARRANTY

ATTACH YOUR RECEIPT HERE. PROOF OF PURCHASE IS REQUIRED TO OBTAIN WARRANTY SERVICE.

Please have the following information available when you call the Customer eXperience Center:

- Name, address and telephone number
- Model number and serial number
- A clear, detailed description of the problem
- Proof of purchase including dealer or retailer name and address

IF YOU NEED SERVICE:

1. Before contacting us to arrange service, please determine whether your product requires repair. Some questions can be addressed without service. Please take a few minutes to review the Troubleshooting or Problem Solver section of the Use and Care Guide, scan the QR code on the right to access additional resources, or visit <http://kitchenaid.custhelp.com>.
2. All warranty service is provided exclusively by our authorized KitchenAid Service Providers. In the U.S. and Canada, direct all requests for warranty service to:

KitchenAid Customer eXperience Center

In the U.S.A., call 1-800-422-1230. In Canada, call 1-800-807-6777.

If outside the 50 United States or Canada, contact your authorized KitchenAid dealer to determine whether another warranty applies.



<http://kitchenaid.custhelp.com>

FIVE YEAR LIMITED WARRANTY

WHAT IS COVERED

FIRST YEAR LIMITED WARRANTY (PARTS AND LABOR)

For one year from the date of purchase, when this major appliance is installed, operated and maintained according to instructions attached to or furnished with the product, KitchenAid brand of Whirlpool Corporation or Whirlpool Canada, LP (hereafter "KitchenAid") will pay for factory specified replacement parts and repair labor to correct defects in materials or workmanship that existed when this major appliance was purchased or, at its sole discretion replace the product. In the event of product replacement, your appliance will be warranted for the remaining term of the original unit's warranty period.

SECOND THROUGH FIFTH YEAR LIMITED WARRANTY (CERTAIN COMPONENT PARTS ONLY - LABOR NOT INCLUDED)

In the second through fifth years from the date of original purchase, when this major appliance is installed, operated and maintained according to instructions attached to or furnished with the product, KitchenAid will pay for factory specified parts for the following components to correct non-cosmetic defects in materials or workmanship in these parts that prevent function of this major appliance and that existed when this major appliance was purchased. This is a limited 5-year warranty on the below named parts only and does not include repair labor.

- Electric element
- Solid state touch control system parts
- Any Gas Burner

YOUR SOLE AND EXCLUSIVE REMEDY UNDER THIS LIMITED WARRANTY SHALL BE PRODUCT REPAIR AS PROVIDED HEREIN. Service must be provided by a KitchenAid designated service company. This limited warranty is valid only in the United States or Canada and applies only when the major appliance is used in the country in which it was purchased. This limited warranty is effective from the date of original consumer purchase. Proof of original purchase date is required to obtain service under this limited warranty.

WHAT IS NOT COVERED

1. Commercial, non-residential or multiple-family use, or use inconsistent with published user, operator or installation instructions.
2. In-home Instruction on how to use your product.
3. Service to correct improper product maintenance or installation, installation not in accordance with electrical or plumbing codes or correction of household electrical or plumbing (i.e. house wiring, fuses or water inlet hoses).
4. Consumable parts (i.e. light bulbs, batteries, air or water filters, etc.).
5. Defects or damage caused by the use of non-genuine KitchenAid parts or accessories.
6. Conversion of your product from natural gas or L.P. gas.
7. Damage from accident, misuse, abuse, fire, floods, acts of God or use with products not approved by KitchenAid.
8. Repairs to parts or systems to correct product damage or defects caused by unauthorized service, alteration or modification of the appliance.
9. Cosmetic damage including scratches, dents, chips, and other damage to appliance finishes unless such damage results from defects in materials and workmanship and is reported to KitchenAid within 30 days.
10. Discoloration, rust or oxidation of surfaces resulting from caustic or corrosive environments including but not limited to high salt concentrations, high moisture or humidity or exposure to chemicals.
11. Food loss due to product failure.
12. Pick-up or delivery. This product is intended for in-home repair.
13. Travel or transportation expenses for service in remote locations where an authorized KitchenAid servicer is not available.
14. Removal or reinstallation of inaccessible appliances or built-in fixtures (i.e. trim, decorative panels, flooring, cabinetry, islands, countertops, drywall, etc.) that interfere with servicing, removal or replacement of the product.
15. Service or parts for appliances with original model/serial numbers removed, altered or not easily determined.

The cost of repair or replacement under these excluded circumstances shall be borne by the customer.

DISCLAIMER OF IMPLIED WARRANTIES

IMPLIED WARRANTIES, INCLUDING ANY IMPLIED WARRANTY OF MERCHANTABILITY OR IMPLIED WARRANTY OF FITNESS FOR A PARTICULAR PURPOSE, ARE LIMITED TO ONE YEAR OR THE SHORTEST PERIOD ALLOWED BY LAW. Some states and provinces do not allow limitations on the duration of implied warranties of merchantability or fitness, so this limitation may not apply to you. This warranty gives you specific legal rights, and you also may have other rights that vary from state to state or province to province.

DISCLAIMER OF REPRESENTATIONS OUTSIDE OF WARRANTY

KitchenAid makes no representations about the quality, durability, or need for service or repair of this major appliance other than the representations contained in this warranty. If you want a longer or more comprehensive warranty than the limited warranty that comes with this major appliance, you should ask KitchenAid or your retailer about buying an extended warranty.

LIMITATION OF REMEDIES; EXCLUSION OF INCIDENTAL AND CONSEQUENTIAL DAMAGES

YOUR SOLE AND EXCLUSIVE REMEDY UNDER THIS LIMITED WARRANTY SHALL BE PRODUCT REPAIR AS PROVIDED HEREIN. KITCHENAID SHALL NOT BE LIABLE FOR INCIDENTAL OR CONSEQUENTIAL DAMAGES. Some states and provinces do not allow the exclusion or limitation of incidental or consequential damages, so these limitations and exclusions may not apply to you. This warranty gives you specific legal rights, and you also may have other rights that vary from state to state or province to province.

