



42" SIDE-BY-SIDE REFRIGERTOR WITH ICE AND WATER DISPENSER

DETAILED PLANNING DIMENSIONS GUIDE

JS42PPDUDE – 41³/₄" (W) x 83³/₈" (H) x 27³/₄" (depth with handles)
 JS42SSDUDE - 41³/₄" (W) x 83³/₈" (H) x 27¹/₈" (depth with handles)

PRODUCT DIMENSIONS

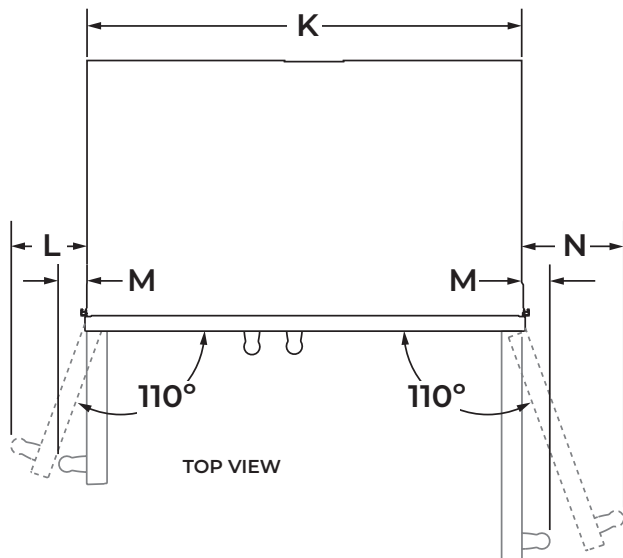
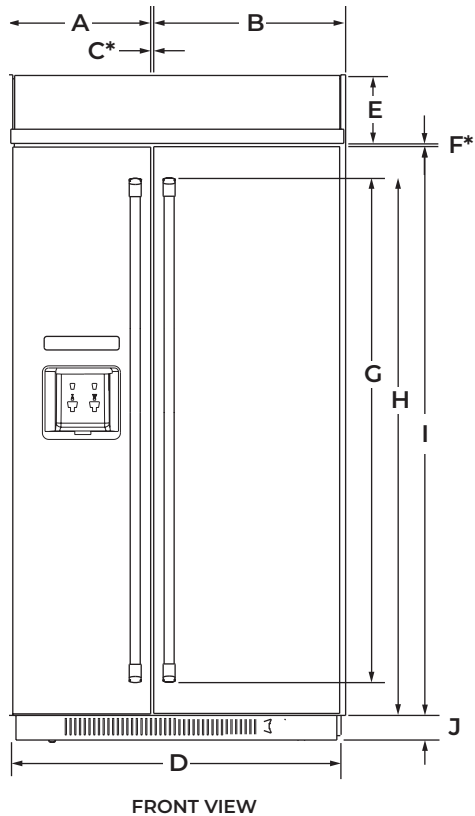

DIMENSION	DESCRIPTION	JS42PPDUDE JS42SSDUDE
A	Width of freezer door (including hinge side offset)	17 ¹ / ₂ " (44.4 cm)
B	Width of refrigerator door (including hinge side offset)	23 ¹ / ₂ " (59.7 cm)
C*	Space between doors	1/ ₄ " (0.6 cm)
D	Overall width (including side trim)	42 ¹ / ₂ " (107.9 cm)
E	Height of top grille	8 ⁵ / ₈ " (21.7 cm)
F*	Space between doors and top grille	3/ ₈ " (1 cm)
G	Height of handles	
	Pro-Style® Stainless	45 ⁹ / ₁₆ " (115.7 cm)
H	Height to top handles	
	Euro Style Stainless	50" (127.1 cm)
I	Height of door	
	Pro-Style® Stainless	63 ¹¹ / ₁₆ " (163.5 cm)
J	Height of bottom grille	
	Euro Style Stainless	63 ³ / ₄ " (167 cm)
K	Height of door	71" (180.2 cm)
L	Height of bottom grille	3" (7.6 cm)
M	Width of recessed refrigerator	41" (104.1 cm)
L	Width from side of refrigerator to freezer handle – door fully open 110°	
	Pro-Style® Stainless	7 ¹ / ₈ " (18.1 cm)
M	Width from side of refrigerator to handle – door open 90°	
	Euro Style Stainless	6 ³ / ₄ " (17.1 cm)
N	Width from side of refrigerator to handle – door open 90°	
	Pro-Style® Stainless	2 ⁵ / ₈ " (6.7 cm)
N	Width from side of refrigerator to refrigerator handle – door fully open 110°	
	Euro Style Stainless	2" (5.1 cm)
N	Width from side of refrigerator to refrigerator handle – door fully open 110°	
	Pro-Style® Stainless	9 ⁵ / ₈ " (24.4 cm)
N	Width from side of refrigerator to refrigerator handle – door fully open 110°	
	Euro Style Stainless	9 ¹ / ₈ " (23.1 cm)

*This can vary from factory.

Because Whirlpool Corporation policy includes a continuous commitment to improve our products, we reserve the right to change materials and specifications without notice.

Dimensions are for planning purposes only. For complete details, see Installation Instructions packed with product. Specifications subject to change without notice.



42" SIDE-BY-SIDE REFRIGERTOR WITH ICE AND WATER DISPENSER

DETAILED PLANNING DIMENSIONS GUIDE

JS42PPDUDE – 41³/₄" (W) x 83³/₈" (H) x 27³/₄" (depth with handles)
 JS42SSDUDE - 41³/₄" (W) x 83³/₈" (H) x 27¹/₈" (depth with handles)

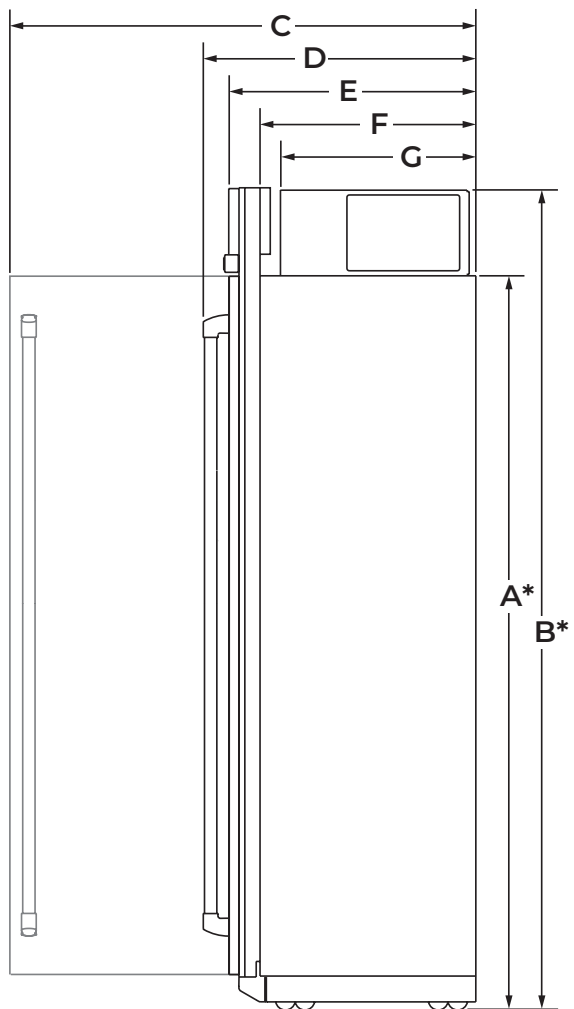

SIDE VIEW

DIMENSION	DESCRIPTION	JS42PPDUDE JS42SSDUDE
A*	Height without (min.)	73 ³ / ₄ " (187.3 cm)
B*	Height of recessed refrigerator (min.)	82 ³ / ₄ " (210.1 cm)
C	Depth with refrigerator door open 90° (min.)	47 ¹ / ₄ " (120 cm)
D	Depth with handles (min.)	
	Pro-Style® Stainless	27 ³ / ₄ " (70.5 cm)
	Euro Style Stainless	27 ¹ / ₈ " (68.8 cm)
E	Depth with doors (min.)	25 ¹ / ₈ " (63.8 cm)
F	Depth without doors (min.)	23 ⁵ / ₈ " (60 cm)
G	Depth of machine compartment (min.)	19 ⁷ / ₈ " (50.5 cm)

*Add 1¹/₄" (3.2 cm) to the height dimension when leveling legs are fully extended.



42" SIDE-BY-SIDE REFRIGERATOR WITH ICE AND WATER DISPENSER

DETAILED PLANNING DIMENSIONS GUIDE

JS42PPDUDE – 41³/₄" (W) x 83³/₈" (H) x 27³/₄" (depth with handles)

JS42SSDUDE - 41³/₄" (W) x 83³/₈" (H) x 27¹/₈" (depth with handles)

OPENING/CLEARANCE DIMENSIONS

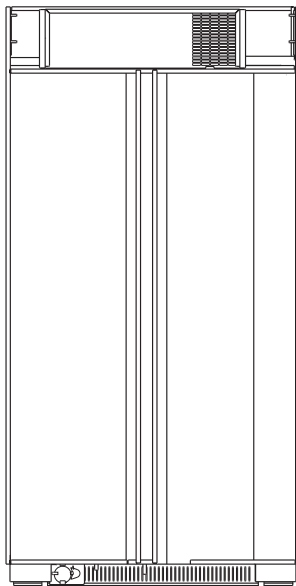
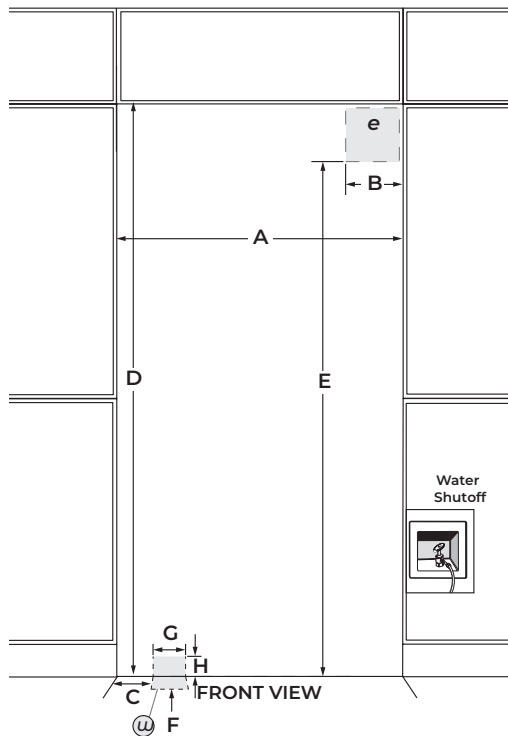

BACK VIEW

DIMENSION	DESCRIPTION	JS42PPDUDE JS42SSDUDE
A	Width (min.)	41 ¹ / ₂ " (105.4 cm)
B	Width of recommended electrical location	7 ¹ / ₂ " (19.1 cm)
C	Distance from side of cabinet to recommended water connection location	6" (15.2 cm)
D	Height (min.)	84" (213.4 cm)
E	Height to recommended electrical location	77" (195.6 cm)
F	Depth of recommended water connection location (max.)	1" (2.5 cm)
G	Width of recommended water connection location	1 ¹ / ₂ " (3.81 cm)
H	Height of recommended water connection location (behind the unit)	2 ¹ / ₂ " (6.35 cm)
e	Recommended electrical connection location	
w	Recommended water connection location	

Because Whirlpool Corporation policy includes a continuous commitment to improve our products, we reserve the right to change materials and specifications without notice.

Dimensions are for planning purposes only. For complete details, see Installation Instructions packed with product. Specifications subject to change without notice.

ELECTRICAL REQUIREMENTS

⚠ WARNING



Electrical Shock Hazard □

- Plug into a grounded 3 prong outlet.** □
- Do not remove ground prong.** □
- Do not use an adapter.** □
- Do not use an extension cord.** □

Failure to follow these instructions can result in death, fire, or electrical shock.

115 V, 60 Hz, AC only, 15 or 20 A fused, grounded circuit is required. A dedicated circuit is recommended. Use an outlet that cannot be turned off by a switch. Minimum length of power cord is 84" (213.4 cm). Do not use an extension cord.

WATER PRESSURE REQUIREMENTS

A cold water supply with water pressure between 30 and 120 psi (207 and 827 kPa) is required to operate the ice maker. Call a licensed, qualified plumber with any questions about the water pressure.

Reverse Osmosis Water Supply

IMPORTANT: The pressure of the water coming out of a reverse osmosis system going to the water inlet valve of the refrigerator needs to be between 30 and 120 psi (207 and 827 kPa).

If a reverse osmosis water filtration system is connected to the cold water supply, the water pressure to the reverse osmosis system needs to be a minimum of 40 to 60 psi (276 to 414 kPa).

LOCATION REQUIREMENTS

⚠ WARNING



Explosion Hazard

- Keep flammable materials and vapors, such as gasoline, away from refrigerator.**
- Failure to do so can result in death, explosion, or fire.**

Floor must be able to support refrigerator (more than 600 lb [272 kg]), door panels and contents of the refrigerator and must be at the same level as flooring in the room.