

30"/27" WARMING DRAWERS

JWD3030E – 29¾" x 10¼" x 26¼"

JWD3027E – 26¾" x 10¼" x 26¼"

PRODUCT DIMENSIONS

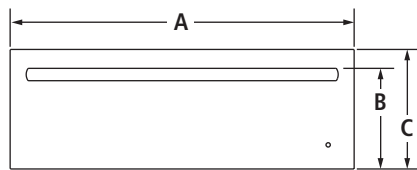

FRONT VIEW

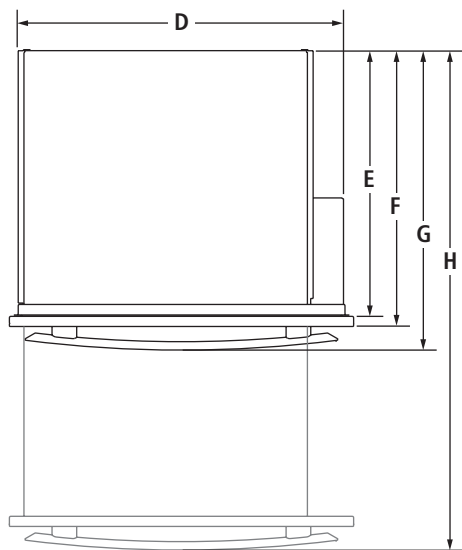

TOP VIEW

MODEL #		JWD3030E		JWD3027E	
		in	cm	in	cm
A	Overall width (max.)	29¾	75.6	26¾	67.9
	Height to top of handle				
B	Pro-Style® Stainless	9⅞	23.2	—	—
	Euro-Style Stainless	9	23.0	9	23.0
	Custom panel (¾"/1.9 cm)	*	*	*	*
C	Overall height (max.)	10¼	26.1	10¼	26.1
D	Width of recessed warming drawer	28¼	71.8	25¼	64.1
E	Depth of recessed warming drawer	23⅞	58.7	23⅞	58.7
F	Depth with drawer	24½	61.4	24½	61.4
G	Depth with handle				
	Pro-Style® Stainless	26⅞	68.1	—	—
	Euro-Style Stainless	26¼	66.6	26¼	66.6
	Custom panel (¾"/1.9 cm)	*	*	*	*
H	Depth with drawer fully open including handle				
	Pro-Style® Stainless	46⅞	117.1	—	—
	Euro-Style Stainless	45½	115.6	45½	115.6
	Custom panel (¾"/1.9 cm)	*	*	*	*

\*These dimensions to be determined by the custom cabinet maker.

**IMPORTANT:** Dimensional specifications are provided for planning purposes only. Do not make any cutouts based on this information. Refer to the Installation Guide before selecting cabinetry, verifying electrical/gas connections, making cutouts or beginning installation. All Jenn-Air® appliances are appropriately UL, CUL or CSA approved.

30"/27" WARMING DRAWERS

JWD3030E – 29<sup>3</sup>/<sub>4</sub>" x 10<sup>1</sup>/<sub>4</sub>" x 26<sup>1</sup>/<sub>4</sub>"

JWD3027E – 26<sup>3</sup>/<sub>4</sub>" x 10<sup>1</sup>/<sub>4</sub>" x 26<sup>1</sup>/<sub>4</sub>"

DIMENSIONS AS INSTALLED

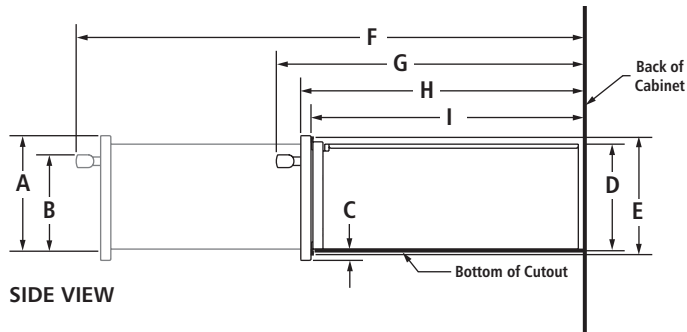

MODEL #		JWD3030E		JWD3027E	
		in	cm	in	cm
<b>A</b>	Height to top of drawer (max.)	10 <sup>1</sup> / <sub>4</sub>	26.1	10 <sup>1</sup> / <sub>4</sub>	26.1
<b>B</b>	Height to top of handle				
	Pro-Style® Stainless	8 <sup>5</sup> / <sub>8</sub>	21.9	—	—
	Euro-Style Stainless	8 <sup>1</sup> / <sub>2</sub>	21.5	8 <sup>1</sup> / <sub>2</sub>	21.5
	Custom panel (¾"/1.9 cm)	*	*	*	*
<b>C</b>	Height of drawer extending below cutout	5 <sup>8</sup> / <sub>8</sub>	1.6	5 <sup>8</sup> / <sub>8</sub>	1.6
<b>D</b>	Height of recessed warming drawer	9	23.0	9	23.0
<b>E</b>	Height of warming drawer flange	9 <sup>7</sup> / <sub>8</sub>	25.0	9 <sup>7</sup> / <sub>8</sub>	25.0
<b>F</b>	Depth with drawer fully open including handle				
	Pro-Style® Stainless	46 <sup>1</sup> / <sub>8</sub>	117.1	—	—
	Euro-Style Stainless	45 <sup>1</sup> / <sub>2</sub>	115.6	45 <sup>1</sup> / <sub>2</sub>	115.6
	Custom panel (¾"/1.9 cm)	*	*	*	*
<b>G</b>	Depth with handle				
	Pro-Style® Stainless	26 <sup>7</sup> / <sub>8</sub>	68.1	—	—
	Euro-Style Stainless	26 <sup>1</sup> / <sub>4</sub>	66.6	26 <sup>1</sup> / <sub>4</sub>	66.6
	Custom panel (¾"/1.9 cm)	*	*	*	*
<b>H</b>	Depth with drawer	24	61.0	24	61.0
<b>I</b>	Depth of recessed warming drawer	23 <sup>1</sup> / <sub>8</sub>	58.8	23 <sup>1</sup> / <sub>8</sub>	58.8

\*These dimensions to be determined by the custom cabinet maker.

**IMPORTANT:** Dimensional specifications are provided for planning purposes only. Do not make any cutouts based on this information. Refer to the Installation Guide before selecting cabinetry, verifying electrical/gas connections, making cutouts or beginning installation. All Jenn-Air® appliances are appropriately UL, CUL or CSA approved.

30"/27" WARMING DRAWERS

JWD3030E – 29¾" x 10¼" x 26¼"

JWD3027E – 26¾" x 10¼" x 26¼"

OPENING/CLEARANCE DIMENSIONS

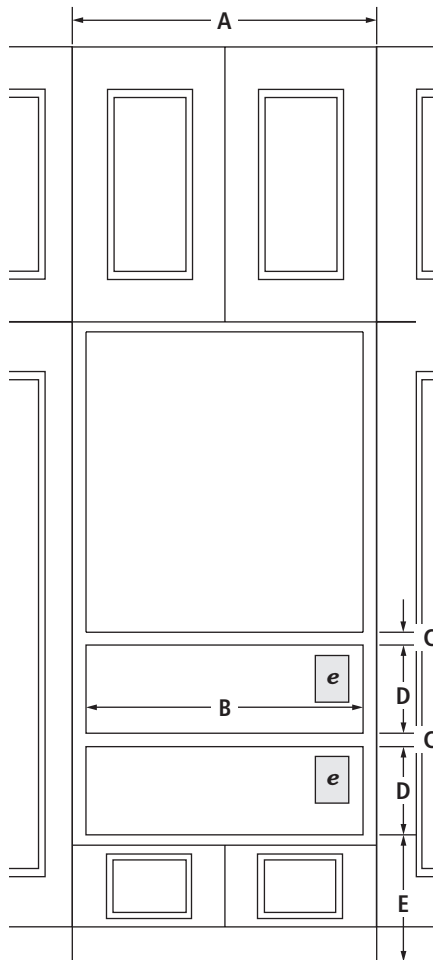

FRONT VIEW

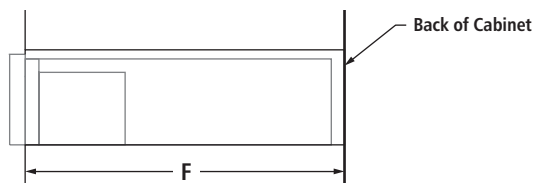

SIDE VIEW

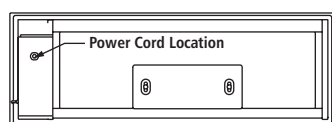

BACK VIEW

MODEL #	JWD3030E		JWD3027E	
	in	cm	in	cm
<b>A</b>	Width of cabinet (min.)			
<b>B</b>	Width of cutout			
<b>C</b>	Height between cutouts (min.)			
<b>D</b>	Height of cutout			
<b>E</b>	Bottom of cutout to floor (recommended)			
	Bottom of cutout to floor (min.)			
<b>F</b>	Depth of cutout (min.)			
<b>e</b>	Recommended outlet location			

**ELECTRICAL REQUIREMENTS**

120 volt, 60 Hz, AC only, 15-amp fused, electrical circuit is required. A dedicated circuit is recommended.

If the outlet is on the rear wall behind the warming drawer, it must be recessed and located in the upper right-hand corner. If outlet is located in an adjacent cabinet, drill a 1½" (3.5 cm) minimum diameter hole in the side wall or support surface to access the power supply cord.

**LOCATION REQUIREMENTS**

Support surface must be solid, level and flush with the bottom of the cabinet cutout. The warming drawer must be leveled before completing installation.

**IMPORTANT:** Dimensional specifications are provided for planning purposes only. Do not make any cutouts based on this information. Refer to the Installation Guide before selecting cabinetry, verifying electrical/gas connections, making cutouts or beginning installation. All Jenn-Air® appliances are appropriately UL, CUL or CSA approved.

## 30"/27" WARMING DRAWERS – FLUSH INSTALLATION

**JWD3030E** – 29¾" x 10¼" x 24½" (depth without handle)

**JWD3027E** – 26¾" x 10¼" x 24½" (depth without handle)

### OPENING/CLEARANCE DIMENSIONS

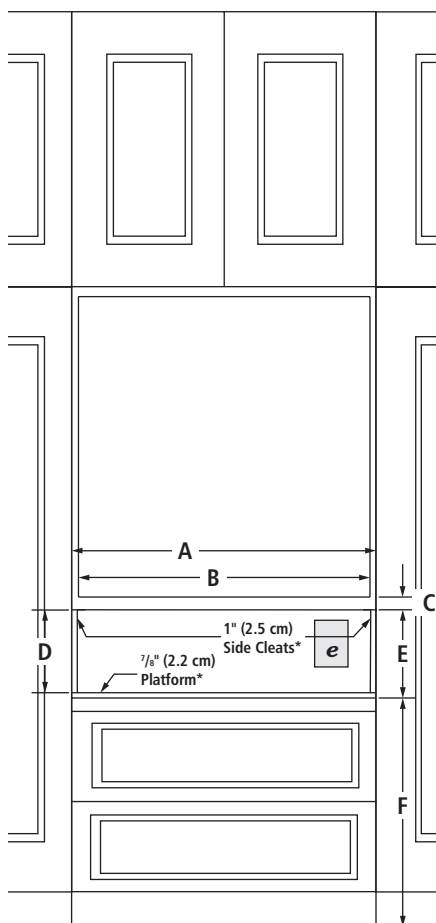

**FRONT VIEW**

MODEL #	JWD3030E		JWD3027E	
	in	cm	in	cm
<b>A</b>	Width of flush inset cutout (min.)			
<b>B</b>	Width of opening (min.)			
<b>C</b>	Height between cutouts (min.)			
<b>D</b>	Height of opening (min.)			
<b>E</b>	Height of flush inset cutout (min.)			
<b>F</b>	Bottom of cutout to floor (recommended)			
	Bottom of cutout to floor (min.)			
<b>G</b>	Depth of cutout (min.)			
<b>e</b>	Recommended outlet location			

### ELECTRICAL REQUIREMENTS

120 volt, 60 Hz, AC only, 15-amp fused, electrical circuit is required. A dedicated circuit is recommended.

If the outlet is on the rear wall behind the warming drawer, it must be recessed and located in the upper right-hand corner. If outlet is located in an adjacent cabinet, drill a 1⅝" (3.5 cm) minimum diameter hole in the side wall or support surface to access the power supply cord.

### LOCATION REQUIREMENTS

Support surface must be solid, level and flush with the bottom of the cabinet cutout. The warming drawer must be leveled before completing installation.

### FLUSH INSTALLATION REQUIREMENTS

A 25" (63.5 cm) minimum cutout depth is required.

These dimensions will result in a ¼" (0.6 cm) reveal on all sides of the warming drawer.

The front face of the cleats and platforms will be visible and should be treated as a finished surface.

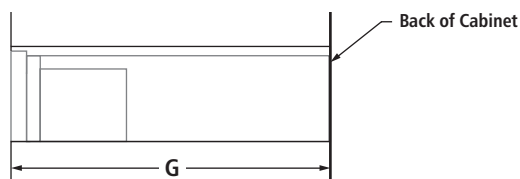

**SIDE VIEW**

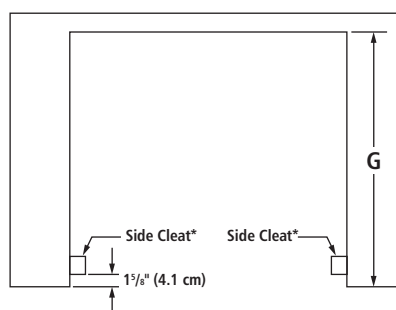

**TOP VIEW**

\*Cleats and platform must be recessed 1⅝" (4.1 cm) from the front of the cabinet.

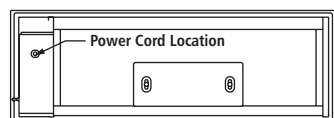

**BACK VIEW**

**IMPORTANT:** Dimensional specifications are provided for planning purposes only.

**Do not make any cutouts based on this information.** Refer to the Installation Guide *before* selecting cabinetry, verifying electrical/gas connections, making cutouts or beginning installation.

All Jenn-Air® appliances are appropriately UL, CUL or CSA approved.