

**Hisense**

life reimagined

# USER'S OPERATION MANUAL

Dishwasher

Before operating this unit, please read this manual thoroughly, and retain for future reference

**HDW63314SS**

English

For questions about features, operation/performance, parts or service, call: **1-855-344-7367**

# Contents

<b>Introduction</b> .....	3
<b>IMPORTANT SAFETY INSTRUCTIONS</b> .....	3
Package contents.....	6
Main components .....	6
<b>Installing and setting up your dishwasher</b> .....	7
Before using your dishwasher .....	7
Finding a suitable location .....	7
Providing a proper power supply .....	7
<b>Understanding your dishwasher's features</b> .....	7
Wash cycle selections .....	7
Filter system .....	8
Smart wash system .....	8
Adjustable upper rack.....	8
<b>Using your dishwasher</b> .....	9
Using the control panel .....	9
Basic operation .....	11
Preparing and loading dishes .....	12
Adding a dish.....	18
Filling the detergent dispenser.....	19
Filling the rinse aid dispenser.....	20
<b>Factors affecting performance</b> .....	21
Using rinse aid .....	21
Water temperature .....	21
Water pressure .....	21
<b>Maintaining your dishwasher</b> .....	22
Cleaning the stainless steel panel .....	22
Cleaning the control panel .....	22
Cleaning the stainless steel inner door and tub .....	22
Cleaning the filters .....	22
Cleaning the door and tub gaskets .....	24
Cleaning the air gap .....	25
<b>Protecting your dishwasher for long periods</b> .....	25
<b>Troubleshooting</b> .....	26
Error codes .....	26
<b>Specifications</b> .....	29

# IMPORTANT SAFETY INSTRUCTIONS

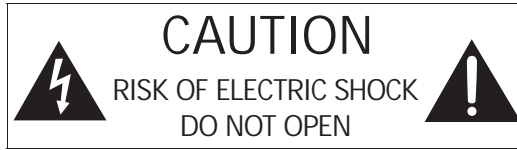

This symbol indicates that dangerous voltage constituting a risk of electric shock is present within your dishwasher.



This symbol indicates that there are important operating and maintenance instructions in the literature accompanying your dishwasher.

## **WARNING** - When using your dishwasher, follow basic safety precautions, including the following:

- 1 Read these instructions.
- 2 Keep these instructions.
- 3 Heed all warnings.
- 4 Follow all instructions.
- 5 Clean only with a damp cloth.
- 6 Do not block any ventilation openings. Install in accordance with the manufacturer's instructions.
- 7 Make sure that the available AC power matches the voltage requirements of this appliance.
- 8 Refer all servicing to qualified service personnel. Servicing is required when the appliance has been damaged in any way or it does not operate normally.



# WARNING

## Electric Shock Hazard

Failure to follow these instructions can result in electric shock, fire, or death.

- 1 WARNING-DANGER** —Never allow children to play with, operate, or crawl inside the dishwasher.
- 2** Turn off the dishwasher before carrying out user maintenance on it.
- 3** If a component part is damaged, it must be replaced by the manufacturer, its service agent, or similar qualified persons in order to avoid a hazard.
- 4** This appliance is intended to be used in household and similar environments.

## Basic precautions before use:

- Read all instructions before using the dishwasher.
- The manual does not cover every possible condition and situation that may occur.
- Use the dishwasher only for intended function as described in this manual.
- When loading items to be washed:
  - Load sharp items and knives so that they are not likely to damage the door seal and tub.
  - Load sharp items and knives with the handles up to reduce the risk of cut-type injury.
- Do not wash plastic items unless they are marked dishwasher safe or the equivalent, if not marked, check with manufacture for recommendation, items that are not dishwasher safe may melt and create a potential fire hazard.
- If the dishwasher drains in to a garbage disposal, make sure disposal is completely empty before running dishwasher.
- Do not tamper with the controls.
- Do not operate your dishwasher unless all enclosure panels are properly in place.
- Do not touch the heating element during or immediately after use, especially if the sanitize option has been selected.
- Do not let children abuse, sit, or stand on door or racks of the dishwasher.
- Under certain conditions, hydrogen gas may be produced in a hot water system that has not been used for two weeks or more. **HYDROGEN GAS IS EXPLOSIVE.** If the hot water system has not been used for such a period, before using on all hot water faucets and let water flow from each for several minutes. This will release any accumulated hydrogen gas. Hydrogen gas is flammable. Do not smoke or use an open flame during this time.

- Do not store or use combustible materials, gasoline or other flammable vapors and liquids in the vicinity of this or any other appliance.
- Use only detergents or rinse agents recommended for use in a dishwasher and keep them out of the reach of children.
- Keep young children and infants away from dishwasher when it is operating.
- Do not use the dishwasher if it has a damaged power line or plug, and do not plug the dishwasher into a damaged outlet, failure to observe these instructions may result in electrical shock.
- Remove the door to the washing compartment when removing an old dishwasher from service or discarding it.
- To reduce the risk of injury, do not allow children to play in or on a dishwasher.

## **SAVE THESE INSTRUCTIONS**

# Package contents

- Dishwasher
- Hose
- Installation kits
- User Guide
- Installation Guide

# Main components

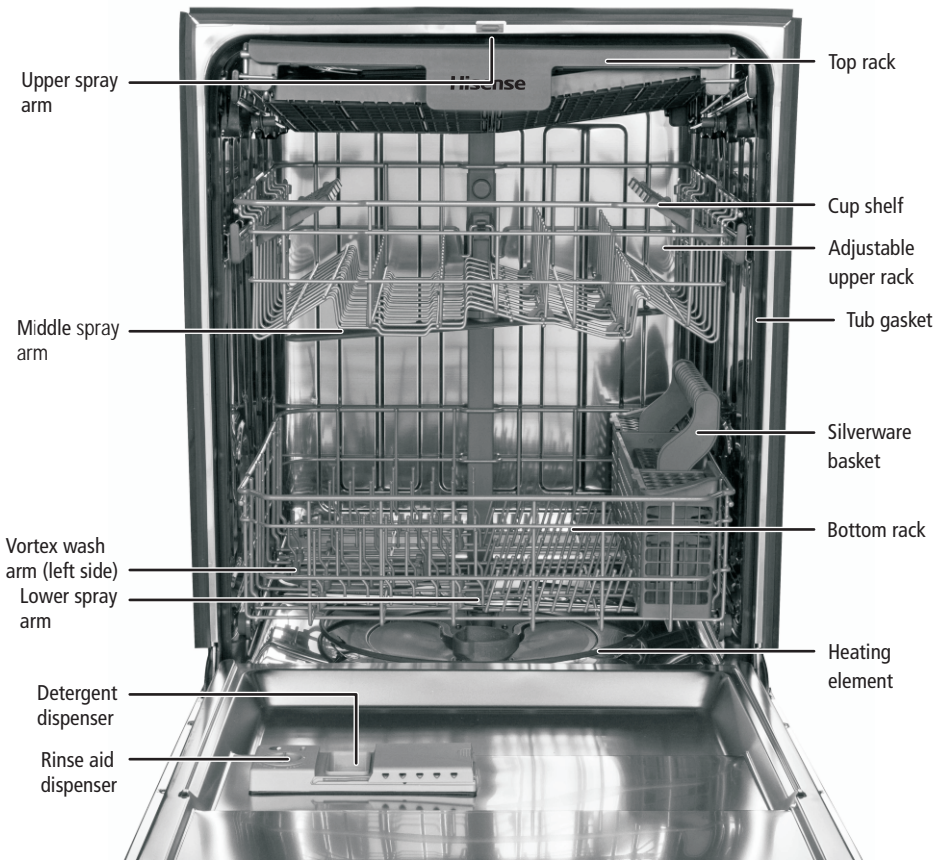

# Installing and setting up your dishwasher

- 1 Water supply temperature should be between 120° F and 149° F (49° C and 65° C).
- 2 Dispose of the discarded appliance and packing material properly.
- 3 The dishwasher must be grounded or it can result in a risk of electric shock.  
If there is any damage of the contact to the dishwasher, please contact
- 4 Customer Service. Do not attempt to repair or replace any part by yourself.

For information on installing and setting up your dishwasher, refer to the Installation Guide provided.

## Before using your dishwasher

- 1 Remove the interior packing.
- 2 Clean the interior surface with lukewarm water using a soft cloth.

## Finding a suitable location

- This dishwasher is designed to be built-in.
- The dishwasher door must be able to swing fully open.

## Providing a proper power supply

Check your local power source. This dishwasher requires a 120V, 60Hz power supply.

Refer to the Installation Guide for additional information

# Understanding your dishwasher's features

## How your dishwasher cleans

The dishwasher fills with water, covering the filter area at the bottom. Water is then pumped through the various filter and spray arms, spraying a mixture of hot water and detergent against the soiled surfaces of your dishes and silverware. Soil particles are separated and go down the drain as the dirty water is drained and replaced with clean water. The number of water fills is determined by the cycle selected.

## Wash cycle selections

Cycle times are approximate and will vary with options selected. Hot water is necessary to activate dishwasher detergent and melt fatty food soils. An automatic sensor checks the incoming water temperature and, if it is not hot enough, the timer will be delayed to allow for the water to heat for the main wash of all cycles. This happens even when hi-temp wash is selected, so that higher temperature will be available to handle heavier soil loads.

## Filter system

Your dishwasher has a multiple filter system which includes four separate filter meshes. It separates dirty water and clean water into different chambers. The multiple filter system helps your dishwasher to get better performance with less water and less energy.

## Smart wash system

Your dishwasher has a smart wash system under the normal wash program which selects the wash cycle based on how large and how soiled the load, permitting your dishwasher to clean more efficiently every time. When a partial load of lightly soiled dishes is placed in the unit, a short wash cycle is automatically selected. When a full load of heavily soiled dishes is placed in the unit, a heavy wash cycle is automatically selected.

## Adjustable upper rack

The upper rack of your dishwasher can be raised or lowered to accommodate loading dishes of varying heights in either rack. After removing the 3rd rack, the upper rack clearance height can be adjusted from 8" to 10". The lower rack clearance height can be adjusted from 11" to 13". See "Adjusting the upper rack" on page 15.

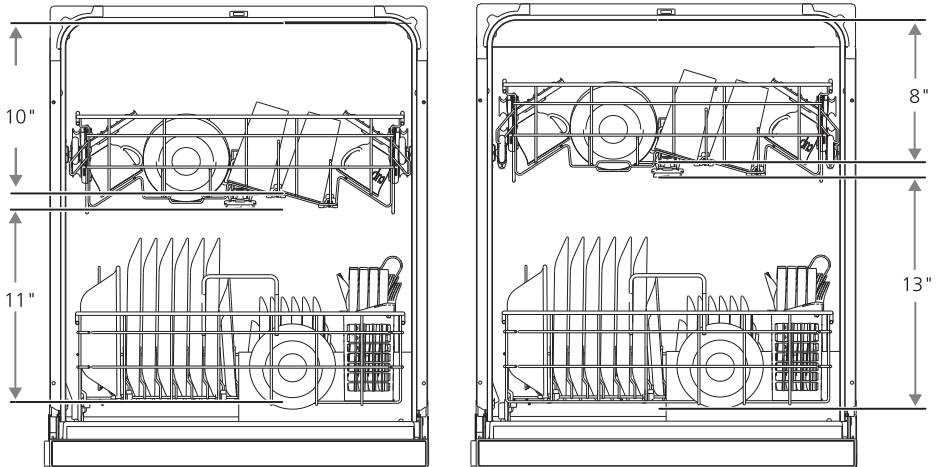



# Using your dishwasher

## Using the control panel

Your dishwasher's control panel is located on the top edge of the door. The door must be opened to make settings and operate the dishwasher.

### Cycles

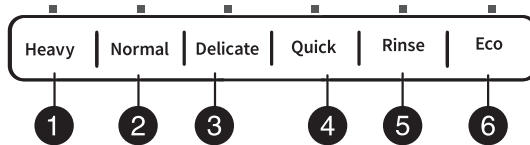

Select a cycle based on the type of dishes to be washed and the level of soil on the dishes.

Cycle times are approximate and will vary with options selected. The timer will be delayed to allow for the water to heat for the main wash of all cycles if the sensor detects the water is not hot enough. Below is water use and cycle times under standard conditions.

#	CYCLE	DESCRIPTION	WATER USE	CYCLE TIME (MINUTES)
1	Heavy	Use for hard-to-clean, heavily soiled dishes, pots, and pans.	6.9 gal. (26.2 l)	138
2	Normal	Use for regularly soiled dinner dishes or silverware.	3.0 - 5.9 gal. (11.4 - 22.5 l)	102-120
3	Delicate	Use for lightly soiled china and crystal.	5.9 gal. (22.5 l)	114
4	Quick	Use for lightly soiled and pre-rinsed dishes and silverware.	4.0 gal. (15.1 l)	60
5	Rinse	Use for pre-rinsing dishes or glasses. This is only a rinse that keeps food from drying on your dishes and reduces odor buildup in your dishwasher until you are ready to wash a full load. Do not use detergent.	2.0 gal. (7.7 l)	20
6	Eco	Use for lightly soiled or pre-rinsed dishes and silverware.	5.0 gal. (18.8 l)	134

## Functions

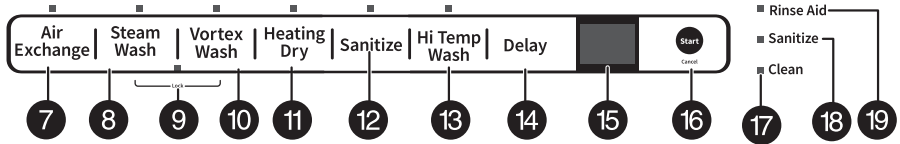

Functions can add enhancements to the cycle selected.

**7 - Air Exchange** —Use to exchange the air in your dishwasher every six hours to keep the air in the dishwasher fresh.

**8 - Steam Wash** —Use for heavily soiled items. This option adds additional time to the cycle time and is available with the **Heavy, Normal,** and **Eco** cycles.

**9 - Lock**—Use to lock all controls to prevent children from accidentally changing the dishwasher cycle or starting the dishwasher. Press the **Steam Wash** and **Vortex Wash** buttons at the same time to select or cancel the function. The indicator light turns on.

**10 - Vortex Wash**—Use when you want to wash pots and pans, durable serving bowls, and other large, very dirty, hard to clean dishes. Place the dishes face down in the lower rack directly above the vortex wash arm in the back left corner of your dishwasher. This function is not available for the rinse only cycle.

**11 - Heating Dry**—Use to heat-dry your dishes. This function is not available for rinse only cycle.

**12 - Sanitize**—Use to sanitize your dishes and glassware. Maintains the water temperature at 158° F (70° C) max., and is available with the **Heavy, Normal,** and **Eco** cycles.

### Notes

- Certified residential dishwashers are not intended for licensed food establishments.
- The sanitize cycle is NSF certified.

**13 - Hi Temp Wash**—Use to maintain the water temperature at 140° F (60° C) max. This option is available with the **Heavy & Normal** cycles.

## Controls and indicators

**14 - Delay**—Press repeatedly to delay the start of the selected wash cycle until the delay time you want is shown on the display. You can select from one to 24 hours delay. After you select the delay time you want, press **Start/Cancel** once, then close the door within four seconds. The delay begins to count down.

If you open the door while delay is running, press the **Start/Cancel**, then close the door within four seconds to begin the cycle from that point.

To cancel the delay and begin the cycle before the delay period is complete, open the door, then press and hold **Start/Cancel** for three seconds.

**15 - Display**—Shows the remaining hours and minutes of the current cycle, delay hours remaining, and error codes (see “Error codes” on page 26).

#### Notes

If the remaining time on the display suddenly increases or decreases by several minutes, it means that the Smart Sensor has checked the soil level or the water needs to be heated to reach the required temperature.

**16 - Start/Cancel**—Press to start the dishwasher after you have selected a cycle and function (if desired). Close the door. The cycle indicator begins to blink and the function indicator turns on. If you don't close the door within four seconds of pressing **Start/Cancel**, the dishwasher pauses. Press **Start/Cancel** again to continue with the cycle.

To cancel a running cycle, open the door, then press and hold **Start/Cancel** for three seconds. The dishwasher will return to standby status.

To load more dishes or pause the dishwasher while it's already running, open the door. A safety mechanism stops the cycle.

#### Caution

To avoid injury open the door slowly and carefully. There is a possibility of hot steam from inside the dishwasher.

You can add more dishes before the main wash cycle has started. To determine this, check the detergent dispenser in the door. If the detergent dispenser is still closed, you can add more dishes. If it is open, you can add dishes to the dishwasher if the dish quantity is small. If the quantity is large, restart the cycle.

**17 - Clean**—Turns on after a cycle finished. Turns off after 1 minute when the door is opened.

**18 - Sanitize**—Turns on when a sanitized cycle is finished. Turns off after 1 minute, when the door is opened.

**19 - Rinse Aid**—Turns on when you need to add rinse aid.

## Basic operation

- 1 Load the dishwasher (See preparing and loading dishes).
- 2 Add detergent (See “Filling the detergent dispenser” on page 19).
- 3 Add rinse aid, if needed (See “Filling the rinse aid dispenser” on page 20).
- 4 Select the cycle you want (See the “Basic operation” on page 11). The indicator will light when the selection is made.
- 5 Select the function you want. The indicator will light when the selection is made.
- 6 To start, press **Start/Cancel** on the control pad.
- 7 Close the door within four seconds and the wash cycle will begin.

## Preparing and loading dishes

### Preparing dishes for washing

- Scrape away large pieces of food, bones, pits, toothpicks, and similar items. The continuous filtered wash system will remove the remaining food particles.

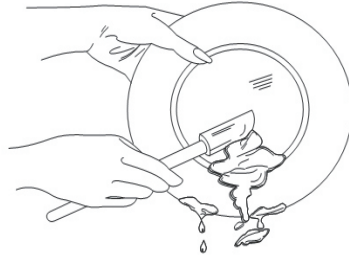

- Burned-on foods should be loosened before loading.
- Empty liquids from glasses and cups.
- Foods such as mustard, mayonnaise, vinegar, lemon juice, and tomato-based products may cause discoloration of stainless steel and plastics if allowed to sit for a long period of time. Unless the dishwasher is to be operated at once, it is best to rinse off these types of foods.
- If the dishwasher drains into a garbage disposal, be sure the disposal is completely empty before starting dishwasher.

## Adjusting the top rack

This dishwasher has a convenient top rack for silverware, cutlery, and small items. This rack can be adjusted to accommodate varying loads, as shown below.

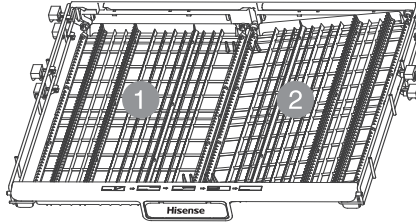

Left rack adjusted to lower position and right rack angled

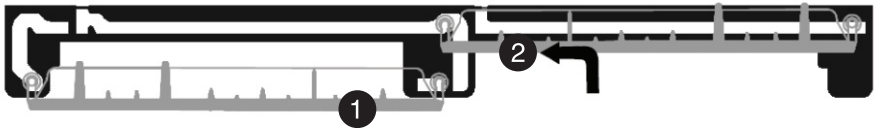

Left rack adjusted to lower position and right rack to upper position



Left rack adjusted to lower position and right rack moved to the left



Left rack adjusted to lower position and right rack removed

## Loading the top rack

You can place the items in the top rack randomly or in an orderly fashion. The image below shows how to load the top rack for 14 place settings:

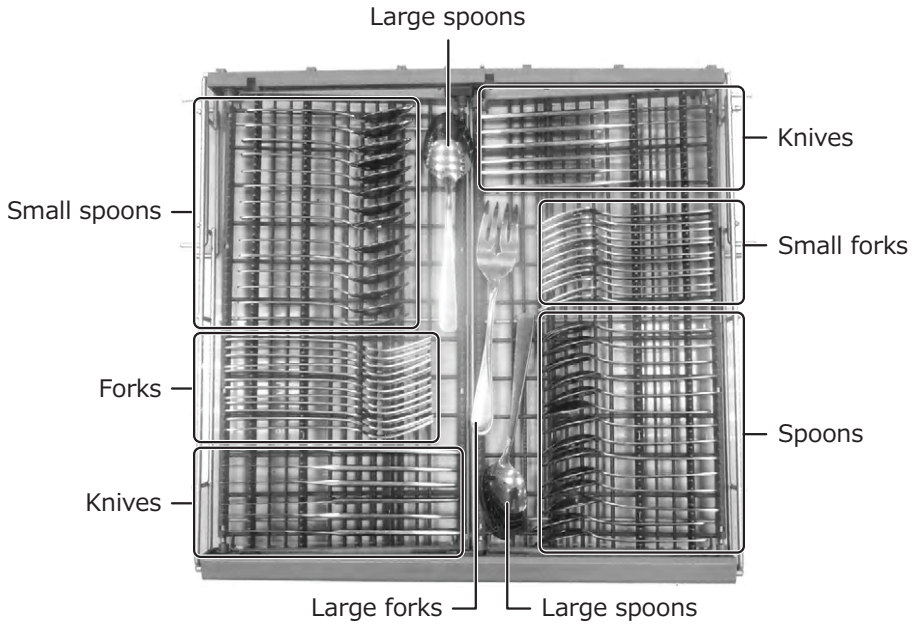

## Adjusting the upper rack

The height of the upper rack can be adjusted to accommodate loading taller dishes in either rack.

- 1 Lift the rack to move it to the upper position.

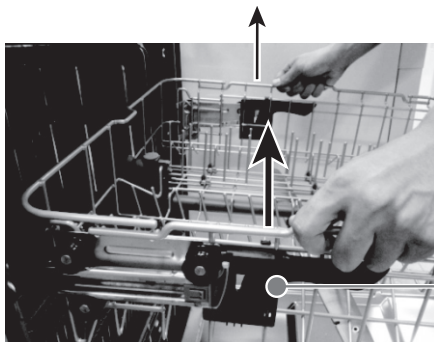

Upper rack in the upper position



- 2 Press the handle to move it to the lower position.

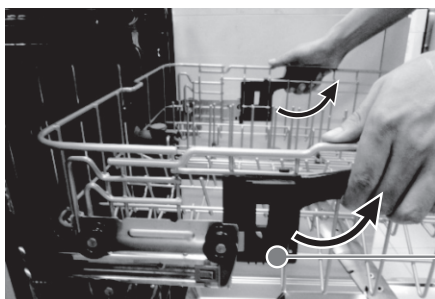

Upper rack in the Lower position



## Loading the upper rack

The upper rack is designed for cups, glasses, small plates, bowls, and plastic items marked dishwasher-safe. For best results, place the items with the soiled surface facing down or toward the center. Tilt them slightly for better drainage.

### Notes

Make sure the loaded dishes do not interfere with the rotation of the middle spray arm, which is located just below the upper rack. You can check this by rotating the middle spray arm by hand.



8 place settings

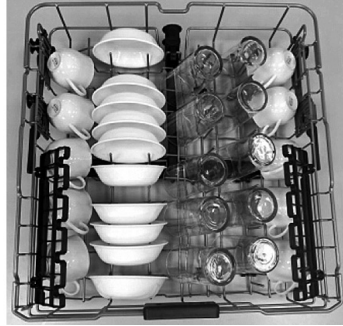

10 place settings

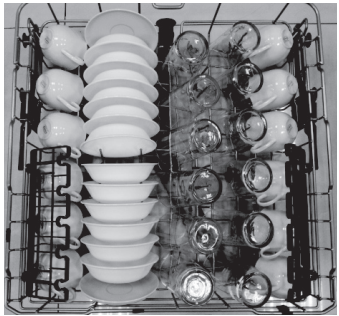

12 place settings

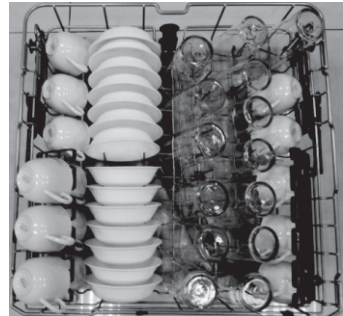

14 place settings



## Loading the bottom rack

The bottom rack is designed to accommodate plates, bowls, saucers, and cookware. The adjustable rack lets you load items up to 13 inches high. Large items should be placed along the edge, with the inside faces down, so they do not interfere with the middle or lower spray arms or prevent the detergent dispenser from opening.

The fold-down tines on the bottom rack are provided to support extra large and hard-to-fit items. The tines may be left up for normal use or folded down for more flexible loading of larger items.

Loading suggestions are shown below:

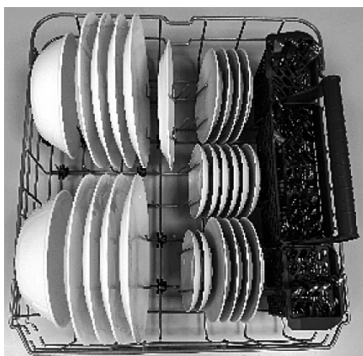

8 place settings



10 place settings



12 place settings

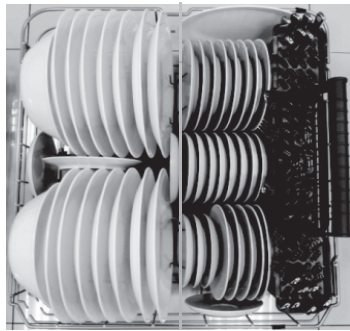

14 place settings

## Loading the silverware basket

The silverware basket is divided into three separate sections, which can be placed in either the upper or lower racks.

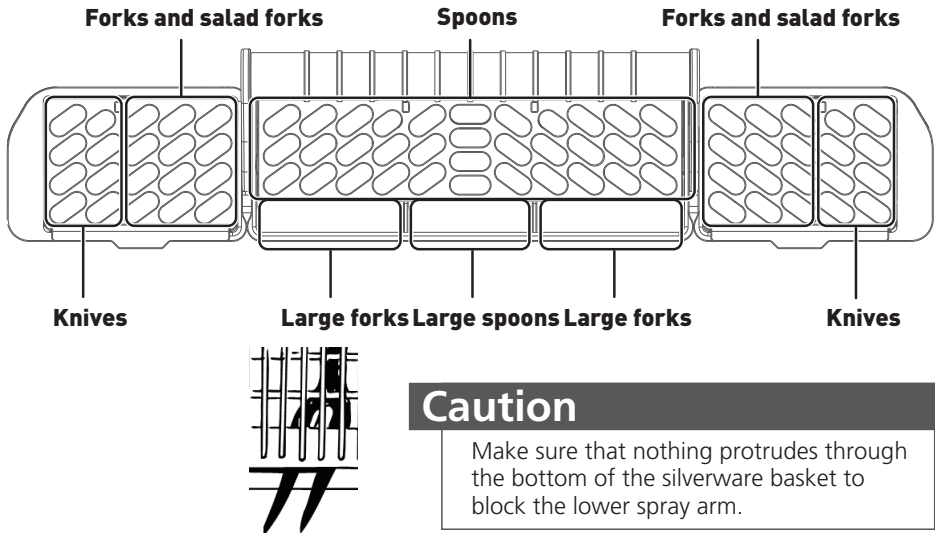

## Adding a dish

### Caution

**TO AVOID BURN INJURY:** Open the door slowly and wait until the spray arms and wash action stop. Hot water may splash out of dishwasher. Failure to do so may result in injury.

Before adding dishes, refer to "Preparing and loading dishes" on page 12 for instructions on loading more dishes. Also see information on Start/cancel in the "Controls and indicators" section on page 10. To add or remove items after the wash cycle starts:

- 1 Open the door slightly and wait a few seconds until wash action stops before completely opening.
- 2 Add the item.
- 3 Press **START/CANCEL** on the control pad and close the door within four seconds. The cycle automatically resumes.

# Filling the detergent dispenser

- 1 Push the detergent dispenser cover latch downwards to open the detergent cup.

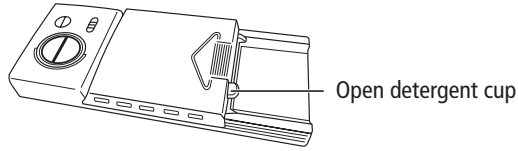

- 2 Add detergent (dry powder, liquid, or packets) to the cup.

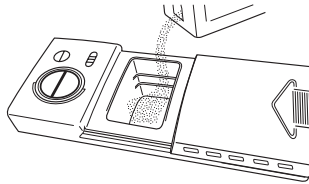

- 3 Close the detergent dispenser cover.

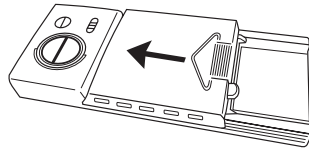

The amount of detergent required depends on the cycle selected and the soil level on the dishes. Refer to the following table for the recommended amount.

Cycle	Soft Water (0-3 grains)	Medium Hard Water (4-8 grains)	Hard Water (9-12 grains)	Very Hard Water (over 12 grains)
Heavy Normal Delicate Quick Eco	5/2 tsp. (main wash cup 1/4 full)	5 tsp. (main wash cup fill to line above regular)	8 tsp. (main wash cup completely full)	Main wash cup completely full (water softener recommended)
Rinse	No detergent	No detergent	No detergent	No detergent

## Filling the rinse aid dispenser

Your dishwasher is designed to use a liquid rinse aid. The use of rinse aid greatly improves drying performance after the final rinse. Do not use a solid or bar-type rinse aid. Under normal conditions, the rinse aid will last approximately one month. Try to keep the dispenser full, but do not over fill it.

- 1 Turn rinse aid dispenser cap 1/4 turn counterclockwise and lift it out.

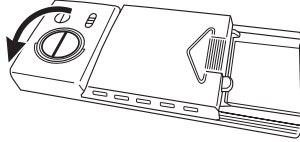

- 2 Add rinse aid until liquid touches the indicated fill level. Do not overfill since this can cause over sudsing. Wipe up any spills with a damp cloth. The dispenser holds enough for 35 to 140 washes, depending on the dial setting.

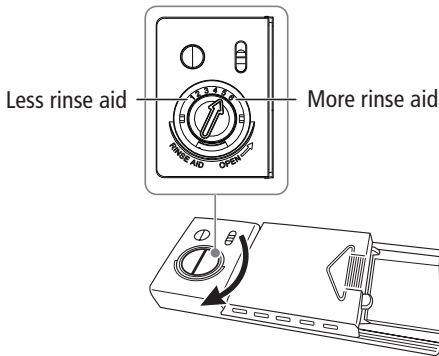
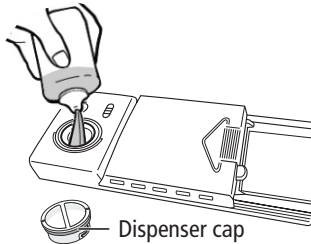

- 3 Replace the cap and turn it 1/4 turn clockwise.

# Factors affecting performance

## Using rinse aid

Rinse aid greatly improves drying and reduces water spots and filming. Without rinse aid, your dishes and dishwasher interior will have excessive moisture.

In addition, the heated dry option will not perform as well without rinse aid.

The rinse aid dispenser, located next to the detergent cup, automatically releases a measured amount of rinse aid during the last rinse.

If spotting and poor drying is a problem, increase the amount of rinse aid dispensed by rotating the dial to a higher number. The dial is located under the dispenser cap.

If the rinse aid is low, the rinse aid light turns on at the beginning and end of the cycle indicating that it is time to refill. Refer to "Filling the rinse aid dispenser" on page 20.

## Water temperature

Hot water is required for optimum dishwashing and drying results. Water entering the dishwasher should be at least 120° F (49° C) to achieve satisfactory results.

To check water temperature entering dishwasher:

- 1 Turn on the hot water faucet near the dishwasher and let it run for several minutes.
- 2 Hold a thermometer (a candy or meat thermometer will work) in the water stream to check the temperature. If temperature is below 120° F (49° C), have a qualified person raise the hot water heater thermostat setting.

### Important

To make sure that the water entering the dishwasher is hot, run hot water from the nearest hot water faucet to clear cool water from the pipe before starting the cycle.

## Heat dry function

The heat dry function, when used with a rinse aid, enhances drying performance. If you do not choose the heat dry function, items in your load that will not be completely dry at the end of the cycle.

## Water pressure

For optimum performance, the hot water supply line for your dishwasher must provide water pressure of at least 20 psi and not more than 120 psi. You may experience low water pressure during high-demand periods, such as when laundry or showers are in use while you are washing the dishes. To eliminate this problem, wait until hot water demand is reduced before starting the dishwasher.

# Maintaining your dishwasher

## Caution

TO AVOID BURN INJURY: Allow the heating element to cool before attempting to clean the interior of your dishwasher.

## Cleaning the stainless steel panel

Clean the stainless steel door and handle regularly with a soft cloth and standard household cleaner to remove the debris

## Caution

Do not use appliance wax, polish, bleach or products containing chlorine to clean the stainless steel door.

## Cleaning the control panel

Clean the control panel gently with a soft, lightly dampened cloth.

## Cleaning the stainless steel inner door and tub

The tub is made of stainless steel. It will not rust or corrode, even if the dishwasher should be scratched or dented.

Clean the spots on the steel inner door and tub with a damp non-abrasive cloth.

## Cleaning the filters

The filters are designed to collect debris and need to be cleaned monthly to maximize wash performance.

- 1 Remove the bottom rack.

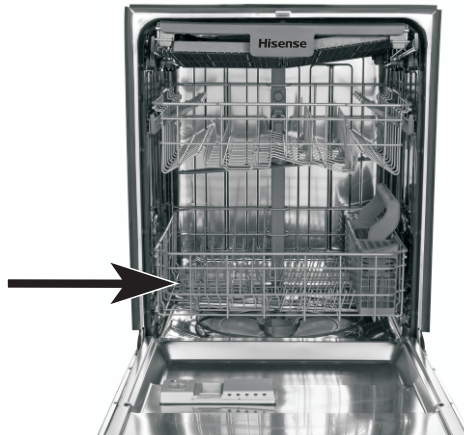

**2** Rotate the cylinder filter, then lift it out.

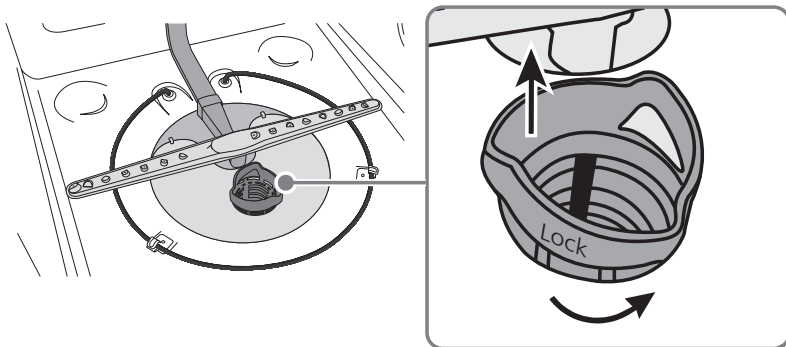

**3** Lift the fine filter from the bottom of the tub.

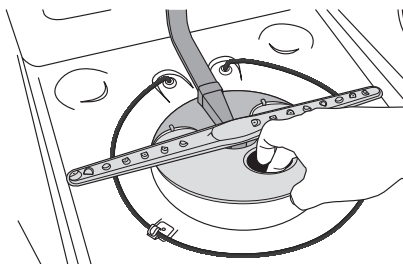

**4** Take out the fabric filter.

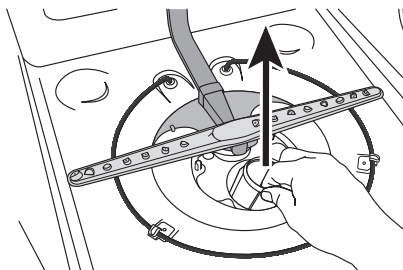

5 Flush the filters by holding them under running water.

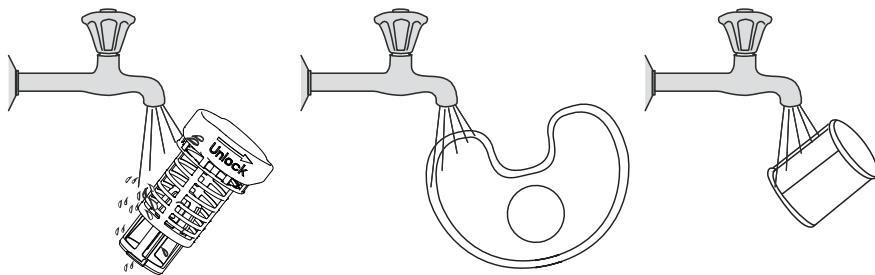

- 6 Replace the fabric filter.
- 7 Replace the fine filter.
- 8 Replace the cylinder filter.
- 9 Replace the bottom rack.

## Cleaning the door and tub gaskets

Clean the door gasket with a damp cloth to remove food particles regularly.

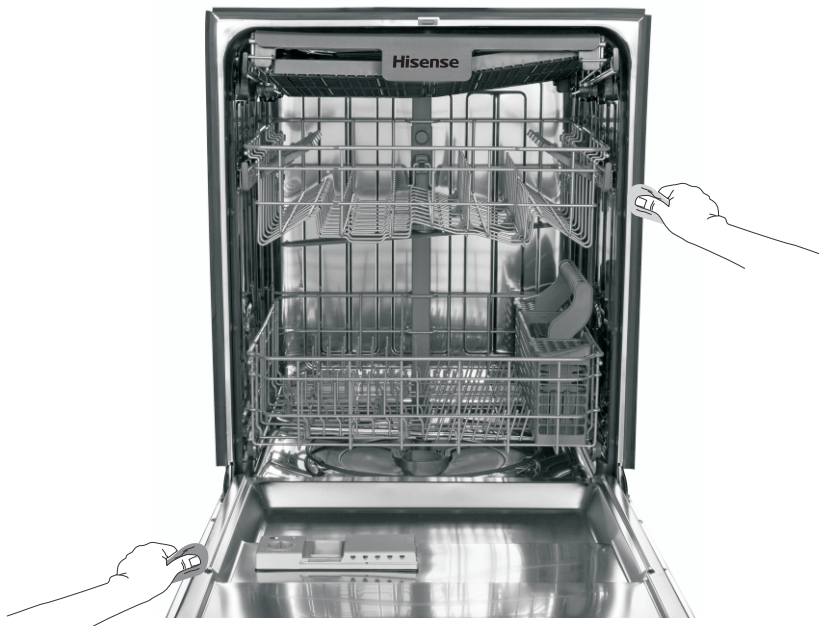



The inside of the dishwasher is self-cleaning under normal use. If needed, the tub gasket can be cleaned with a damp cloth. Use a brush to clean the opening in the end of the gasket.



## Cleaning the air gap

If there is an air gap installed with your dishwasher, make sure it is clean so the dishwasher will drain properly. Air gap is not part of your dishwasher. Before you clean the air gap, turn off the dishwasher, then remove the plastic air gap cover and clean with a toothpick.

## Protecting your dishwasher for long periods

Your dishwasher should be protected from freezing if you plan to leave it for extended periods in an unheated place. Have a qualified person do the following:

### To disconnect service:

- 1 Turn off the electrical power to the dishwasher at the supply source by moving fuses or tripping circuit breaker.
- 2 Turn off the water supply.

3 Place a pan under the inlet valve, then disconnect water line from the inlet valve and drain it into a pan.

4 Disconnect drain line from pump and drain the water into a pan.

**To restore service:**

1 Reconnect the water, drain, and electrical power.

2 Turn on water and electrical power supply.

3 Fill the detergent cup and the rinse aid cup and run the dishwasher through a heated-wash cycle.

4 Check all connections to make sure they do not leak.

## Troubleshooting

Refer to this table to correct minor issues before calling for service.

### Error codes

CODE	MEANING	POSSIBLE CAUSE
E1	Longer inlet time	<ul style="list-style-type: none"><li>• Faucet is not opened</li><li>• Water intake is restricted</li><li>• Water pressure is too low</li></ul>
E4	Overflow	A leak in the dishwasher
E8	The orientation of the distributary valve not working.	The wire is not connected correctly, or the distributary valve is broken.
E9	A button has been touched for more than 30 seconds (by anything, including water).	Anything (including water) touching a button.

### Caution

- If an overflow occurs, turn off the main water supply before calling for service.
- If there is water in the base pan because of an overfill or small leak, the water should be removed before restarting the dishwasher.

<b>PROBLEM</b>	<b>POSSIBLE CAUSE</b>	<b>POSSIBLE SOLUTION</b>
The dishwasher won't start	The door may not be closed properly.	Make sure that the door is closed and latched.
	The power is off or not connected.	Make sure that the power is connected and turned on.
	The delay start option is selected.	Refer to the "Delay" section under "Controls and indicators" on page 10.
	The child lock is activated.	Deactivate the child lock. Refer to the "Child lock" section under "Functions" on page 10.
The dishwasher beeps at the end of the cycle	This is normal and indicates that the wash cycle is complete.	
The rinse aid light is on	The rinse aid level is low.	Add rinse aid.
The dishwasher runs too long	The dishwasher is connected to a cold water supply.	Make sure that the dishwasher is connected to a hot water supply. If not, change the water supply to a hot water source.
	The cycle time varies, depending on the soil level of the dishes.	When heavy soil is detected, the wash times will be longer.
	Depends on the option selected.	Some options will add time to the cycle.
The dishes are not clean enough	The water pressure is too low.	Make sure that the water pressure is above 20 psi. Use your dishwasher when water demand is low.
	The inlet water temperature is too low.	Make sure that the dishwasher is connected to a hot water supply. If not, change the water supply to a hot water source. Use your dishwasher when hot water demand is low.
	Dishes are too close together.	Reload the dishwasher as shown in "Preparing and loading dishes" on page 12.
	Improper use of detergent.	Add detergent depending on the water hardness and washing cycle you choose. Use fresh detergent.
	The selected cycle is not suitable for the soil level on the dishes.	Choose a different cycle with a longer washing time.
	The spray arms are blocked.	Make sure that the spray arms are not blocked and are free to rotate.
The dishes are not drying enough	The rinse aid dispenser is empty or the setting is too low.	Fill the rinse aid dispenser. Increase the rinse aid setting.
	Dishes are loaded improperly.	Reload the dishwasher as shown in "Preparing and loading dishes" on page 12.
	The cycle you chose did not include drying.	Choose a cycle with drying.

<b>PROBLEM</b>	<b>POSSIBLE CAUSE</b>	<b>POSSIBLE SOLUTION</b>
Spots and filming on dishes	Water hardness is too high	For extremely hard water, install a water softener.
	Dishes are loaded improperly.	Reload the dishwasher as shown in "Preparing and loading dishes" on page 12.
	Old or damp rinse aid power is used.	Use fresh, liquid rinse aid.
	The rinse aid dispenser is empty or the setting is too low.	Fill the rinse aid dispenser. Increase the rinse aid setting.
Etching	Using too much detergent.	Use less detergent if you have soft water.
	The inlet water temperature exceeds 150° F (65.6° C).	Lower the inlet water temperature.
Detergent left in dispenser cup	Detergent may be too old.	Use fresh detergent.
	The spray arm is blocked.	When you load the dishes, make sure that the spray arms are not blocked.
The detergent dispenser will not close	Improper operation of the detergent cover.	Add detergent and rinse aid only as indicated in this manual. See "Filling the detergent dispenser" and "Filling the rinse aid dispenser" on page 20.
Water remains in the dishwasher.	The previous cycle has not finished or has been interrupted.	Make sure that the current cycle is finished.
The dishwasher does not drain properly.	The drain is clogged.	Check the air gap (if so equipped). Make sure that the disposer is empty (if so connected).
	The drain hose is kinked.	Make sure that the drain hose is not kinked and is properly connected.
Suds in the tub	Using improper detergent.	Make sure to use only automatic dishwasher detergent.
The dishwasher leaks	Excessive suds caused by using improper detergent.	Make sure to use only automatic dishwasher detergent.
	The dishwasher is not level.	Level the dishwasher (refer to the Installation Manual).
There are black or gray marks on the dishes	Aluminum utensils have rubbed against the dishes.	Make sure that the water inlet temperature is not less than 120° F (49° C).
The interior of the tub is stained	Coffee or tea stains.	Use a spot cleaner to remove the stains.
	Reddish stain.	Some tomato products may cause this. Use of the rinse only cycle right after loading will help this.
Noises	Detergent cup opening/drain pump.	This is normal.
	A hard object has entered the wash module. When the object is ground up the noise will stop.	If the noise continues after the cycle is complete, call for service.
The dishwasher won't fill (the dishwasher will beep)	The water valve is turned off.	Turn on the water valve.
	The door may not be closed completely.	Make sure that the door is closed and latched.

# Specifications

Specifications	Capacity Max 14 place settings
Dimensions (WxDxH)	Bar handle unit - 23.9 x 26.5 x 33.7 in. (606 x 674 x 857 mm) Recess handle unit - 23.9 x 24.5 x 33.7 in. (606 x 623 x 857 mm)
Power requirements	120 V~60 Hz
Current	8.4 A
Water pressure	Between 20 and 120 psi

**Hisense**



877915-a3

*We reserve the right to make changes.*