



Self-Cleaning Dual Fuel Gas RANGES

SAFETY INFORMATION 3

USING THE RANGE

In Case of a Power Failure 8

Surface Burners 8

Griddle10

Oven Controls.....12

WiFi Connect13

Special Features.....14

Sabbath Mode - Enhanced15

Sabbath Mode - Standard.....16

Oven Racks17

Aluminum Foil and Oven Liners.....17

Oven Cooking Modes18

Oven Air Vents18

Oven Cooking Guide19

Air Fry Cooking Guide.....21

CARE AND CLEANING

Range - Exterior..... 22

Range - Interior 23

Cooktop..... 24

Door and Drawer 26

Oven Light..... 27

Oven Door..... 28

TROUBLESHOOTING TIPS..... 29

LIMITED WARRANTY 34

ACCESSORIES 35

CONSUMER SUPPORT 36

OWNER'S MANUAL

PC2B935

Write the model and serial numbers here:

Model # _____

Serial # _____

You can find the rating label on the front behind the range drawer.

ESPAÑOL

Para consultar una version en español de este manual de instrucciones, visite nuestro sitio de internet GEAppliances.ca/en/

THANK YOU FOR MAKING GE APPLIANCES A PART OF YOUR HOME.

Whether you grew up with GE Appliances, or this is your first, we're happy to have you in the family.

We take pride in the craftsmanship, innovation and design that goes into every GE Appliances product, and we think you will too. Among other things, registration of your appliance ensures that we can deliver important product information and warranty details when you need them.

Register your GE appliance now online. Helpful websites and phone numbers are available in the Consumer Support section of this Owner's Manual. You may also mail in the pre-printed registration card included in the packing material.



IMPORTANT SAFETY INFORMATION

READ ALL INSTRUCTIONS BEFORE USING THE APPLIANCE

⚠ WARNING Read all safety instructions before using the product. Failure to follow these instructions may result in fire, electrical shock, serious injury or death.

⚠ WARNING If the information in this manual is not followed exactly, a fire or explosion may result, causing property damage, personal injury or death.

- Do not store or use gasoline or other flammable vapors and liquids in the vicinity of this or any other appliance.
- **WHAT TO DO IF YOU SMELL GAS**
 - Do not try to light any appliance.
 - Do not touch any electrical switch; do not use any phone in your building.
 - Immediately call your gas supplier from a neighbor's phone. Follow the gas supplier's instructions.
 - If you cannot reach your gas supplier, call the fire department.
- Installation and service must be performed by a qualified installer, service agency or the gas supplier.

ANTI-TIP DEVICE

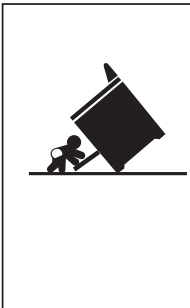

⚠ WARNING

Tip-Over Hazard

- A child or adult can tip the range and be killed.
- Install the anti-tip bracket to the wall or floor.
- Engage the range to the anti-tip bracket by sliding the range back such that the foot is engaged.
- Re-engage the anti-tip bracket if the range is moved.
- Failure to do so can result in death or serious burns to children or adults.

To reduce the risk of tipping the range, the range must be secured by a properly installed anti-tip bracket. See installation instructions shipped with the bracket for complete details before attempting to install.

For Free-Standing and Slide-In Ranges

To check if the bracket is installed and engaged properly, look underneath the

range to see that the rear leveling leg is engaged in the bracket. On some models, the storage drawer or kick panel can be removed for easy inspection. If visual inspection is not possible, slide the range forward, confirm the anti-tip bracket is securely attached to the floor or wall, and slide the range back so the rear leveling leg is under the anti-tip bracket.

If the range is pulled from the wall for any reason, always repeat this procedure to verify the range is properly secured by the anti-tip bracket.

Never completely remove the leveling legs or the range will not be secured to the anti-tip device properly.

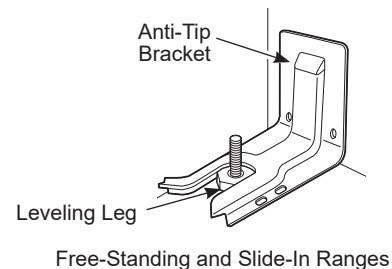

READ AND SAVE THESE INSTRUCTIONS

IMPORTANT SAFETY INFORMATION

READ ALL INSTRUCTIONS BEFORE USING THE APPLIANCE

▲WARNING GENERAL SAFETY INSTRUCTIONS

▲WARNING NEVER use this appliance as a space heater to heat or warm the room. Doing so may result in carbon monoxide poisoning and overheating of the oven.

- Use this appliance for its intended purpose as described in this owner's manual.
- Have your range installed and properly grounded by a qualified installer in accordance with the provided installation instructions.
- Any adjustment and service should be performed only by a qualified gas range installer or service technician. Do not attempt to repair or replace any part of your range unless it is specifically recommended in this manual.
- Your range is shipped from the factory set for use with natural gas. It can be converted for use with propane gas. If required, these adjustments must be made by a qualified technician in accordance with the installation instructions and local codes. The agency performing this work assumes responsibility for the conversion.
- Have the installer show you the location of the range gas shut-off valve and how to turn it off if necessary.
- Plug your range into a 120-volt grounded outlet only. Do not remove the round grounding prong from the plug. If in doubt about the grounding of the home electrical system, it is your responsibility and obligation to have an ungrounded outlet replaced with a properly grounded, three prong outlet in accordance with the National Electrical Code. Do not use an extension cord with this appliance.
- Before performing any service, unplug the range or disconnect the power supply at the household distribution panel by removing the fuse or switching off the circuit breaker.
- Be sure all packing materials are removed from the range before operating to prevent ignition of these materials.
- Avoid scratching or impacting glass doors, cooktops, or control panels. Doing so may lead to glass breakage. Do not cook on a product with broken glass. Shock, fire, or cuts may occur.
- Dual Fuel: If the heating element in the oven develops a glowing spot or shows other signs of damage, do not use that area of the range. A glowing spot indicates the element may fail and present a potential burn, fire, or shock hazard. Turn the heating element off immediately and have it replaced by a qualified service technician.
- Do not leave children alone or unattended in an area where an appliance is in use. They should never be allowed to climb, sit or stand on any part of the appliance.
- **▲CAUTION** Do not store items of interest to children in cabinets above an oven - children climbing on the oven to reach items could be seriously injured.
- Never block the vents (air openings) of the range. They provide the air inlets and outlets that are necessary for the range to operate properly with correct combustion. Air openings are located at the rear of the cooktop, at the top and bottom of the oven door, and at the bottom of the range under the drawer, lower oven drawer or kick panel.
- Use only dry pot holders—moist or damp pot holders on hot surfaces may result in burns from steam. Do not let pot holders touch surface burners, burner grate, or oven heating element. Do not use a towel or other bulky cloth in place of pot holders.
- Do not touch the heating elements or the interior surface of the oven. These surfaces may be hot enough to burn even though they are dark in color. During and after use, do not touch, or let clothing or other flammable materials contact any interior area of the oven; allow sufficient time for cooling first. Other surfaces of the appliance may become hot enough to cause burns. Potentially hot surfaces include the burners, grates, oven vent opening, surfaces near the opening, and crevices around the oven door.
- Do not heat unopened food containers. Pressure could build up and the container could burst, causing an injury.
- Cook food thoroughly to help protect against foodborne illness. Minimum safe food temperature recommendations can be found at www.IsItDoneYet.gov and www.fsis.usda.gov. Use a food thermometer to take food temperatures and check several locations.
- Do not allow anyone to climb, stand or hang on the oven door, drawer or cooktop. They could damage the range or tip it over causing severe injury or death.

READ AND SAVE THESE INSTRUCTIONS

IMPORTANT SAFETY INFORMATION

READ ALL INSTRUCTIONS BEFORE USING THE APPLIANCE

▲WARNING KEEP FLAMMABLE MATERIALS AWAY FROM THE RANGE

Failure to do so may result in fire or personal injury.

- Do not store or use flammable materials in an oven or near the cooktop, including paper, plastic, pot holders, linens, wall coverings, curtains, drapes and gasoline or other flammable vapors and liquids.
- Never wear loose-fitting or hanging garments while using the appliance. These garments may ignite if they contact hot surfaces causing severe burns.
- Do not let cooking grease or other flammable materials accumulate in or near the range. Grease in the oven or on the cooktop may ignite.

▲WARNING IN THE EVENT OF A FIRE, TAKE THE FOLLOWING STEPS TO PREVENT INJURY AND FIRE SPREADING

- Do not use water on grease fires. Never pick up a flaming pan. Turn the controls off. Smother a flaming pan on a surface unit by covering the pan completely with a well-fitting lid, cookie sheet or flat tray. Use a multi-purpose dry chemical or foam-type fire extinguisher.
- If there is a fire in the oven during baking, smother the fire by closing the oven door and turning the oven off or by using a multi-purpose dry chemical or foam-type fire extinguisher.
- If there is a fire in the oven during self-clean, turn the oven off and wait for the fire to go out. Do not force the door open. Introduction of fresh air at self-clean temperatures may lead to a burst of flame from the oven. Failure to follow this instruction may result in severe burns.

▲WARNING COOKTOP SAFETY INSTRUCTIONS

▲WARNING NEVER Operate the Top Surface Cooking Section of this Appliance Unattended.

- Failure to follow this warning statement could result in fire, explosion, or burn hazard that could cause property damage, personal injury, or death.
 - If a fire should occur, keep away from the appliance and immediately call your fire department.
- DO NOT ATTEMPT TO EXTINGUISH AN OIL/GREASE FIRE WITH WATER.**

- Never leave the surface burners unattended. Foods, especially oily foods, may ignite resulting in fire that could spread to surrounding cabinets.
- Never leave oil unattended while frying. If allowed to heat beyond its smoking point, oil may ignite resulting in fire that may spread to surrounding cabinets. Use a deep fat thermometer whenever possible to monitor oil temperature.
- To avoid oil spillover and fire, use the minimum amount of oil when using a shallow pan-frying and avoid cooking frozen foods with excessive amounts of ice.
- Use proper pan size and avoid pans that are unstable or easily tipped. Select cookware that is matched to the size of the burner. Burner flames should be adjusted so that they do not extend beyond the bottom of the pan. Excessive flame may be hazardous.
- Always use the LITE position when igniting the top burners and make sure the burners have ignited.
- When using glass/ceramic cookware, make sure it is suitable for cooktop service; others may break because of sudden change in temperature.
- To minimize the possibility of burns, ignition of flammable materials and spillage, the handle of a container should be turned toward the center of the range without extending over nearby burners.

READ AND SAVE THESE INSTRUCTIONS

IMPORTANT SAFETY INFORMATION

READ ALL INSTRUCTIONS BEFORE USING THE APPLIANCE

▲WARNING COOKTOP SAFETY INSTRUCTIONS (Cont.)

- Do not use a wok with a round metal support ring. The ring may trap heat and block air to the burner resulting in a carbon monoxide hazard.
- Do not attempt to lift the cooktop. Doing so may damage the gas tubing to the surface burners resulting in a gas leak and risk of fire.
- When disabling Lock Control (on some models), make sure the surface controls are set to the OFF position. This will prevent unintended gas flow from the burners.
- Do not use aluminum foil to cover the grates or line any part of the cooktop. Doing so may result in carbon monoxide poisoning, overheating of the cooktop surfaces, or a potential fire hazard.

▲WARNING OVEN SAFETY INSTRUCTIONS

▲WARNING NEVER cover any slots, holes, or passages in the oven bottom or cover an entire rack with materials such as aluminum foil or oven liners. Doing so blocks air flow through the oven and may cause carbon monoxide poisoning. Never place foil or oven liners on the oven bottom. They can trap heat causing risk of smoke or fire.

- Stand away from the range when opening the oven door. Hot air or steam which escapes can cause burns to hands, face and/or eyes.
- Never place cooking utensils, pizza or baking stones, or any type of foil or liner on the oven floor. These items can trap heat or melt, resulting in damage to the product and risk of shock, smoke or fire.
- Place oven racks in desired location while oven is cool. If rack must be moved while oven is hot, be careful to avoid touching hot surfaces.
- Do not leave items such as paper, cooking utensils, or food in the oven when not in use. Items stored in an oven can ignite.
- Do not leave items on the cooktop near the oven vent. Items may overheat resulting in a risk of fire or burns.
- Never broil with door open. Open-door broiling is not permitted due to overheating of control knobs.

▲WARNING SELF-CLEANING OVEN SAFETY INSTRUCTIONS

The self-cleaning feature operates the oven at temperatures high enough to burn away food soils in the oven. Follow these instructions for safe operation.

- Do not touch oven surfaces during self-clean operation. Keep children away from the oven during self-cleaning. Failure to follow these instructions may cause burns.
- Before operating the self-clean cycle, remove pans, shiny metal oven racks, and other utensils from the oven. Only porcelain-coated oven racks may be left in the oven.
- Before operating the self-clean cycle, wipe grease and food soils from the oven. Excessive amount of grease may ignite leading to smoke damage to your home.
- If the self-cleaning mode malfunctions, turn the oven off and disconnect the power supply. Have it serviced by a qualified technician.
- Do not use oven cleaners. No commercial oven cleaner or oven liner protective coating of any kind should be used in or around any part of the oven.
- Do not clean the door gasket. The door gasket is essential for a good seal. Care should be taken not to rub, damage or move the gasket.
- **IMPORTANT:** The health of some birds is extremely sensitive to the fumes given off during the self-cleaning cycle of any range. Move birds to another well-ventilated room.

READ AND SAVE THESE INSTRUCTIONS

IMPORTANT SAFETY INFORMATION

READ ALL INSTRUCTIONS BEFORE USING THE APPLIANCE

Remote Enable Equipment

This device complies with part 15 of the FCC Rules. Operation is subject to the following two conditions: (1) This device may not cause harmful interference, and (2) this device must accept any interference received, including interference that may cause undesired operation.

The wireless communication equipment installed on this range has been tested and found to comply with the limits for a Class B digital device, pursuant to part 15 of the FCC Rules. These limits are designed to:

(a) provide reasonable protection against harmful interference in a residential installation. This equipment generates, uses, and can radiate radio frequency energy and, if not installed and used in accordance with the instructions, may cause harmful interference to radio communications. However, there is no guarantee that interference will not occur in a particular installation. If this equipment does cause harmful interference to radio or television reception, which can be determined by turning the equipment off and on, the user is encouraged to try to correct the interference by one or more of the following measures:

- Reorient or relocate the receiving antenna.
- Increase the separation between the equipment and receiver.
- Connect the equipment into an outlet on a circuit different from that to which the receiver is connected.
- Consult the dealer or an experienced radio/TV technician for help.

(b) accept any interference received, including interference that may cause undesired operation of the device.

Note that any changes or modifications to the wireless communication device installed on this oven that are not expressly approved by the manufacturer could void the user's authority to operate the equipment.

How to Remove Protective Shipping Film and Packaging Tape

Carefully grasp a corner of the protective shipping film with your fingers and slowly peel it from the appliance surface. Do not use any sharp items to remove the film. Remove all of the film before using the appliance for the first time.

To assure no damage is done to the finish of the product, the safest way to remove the adhesive from packaging tape on new appliances is an application of a household liquid dishwashing detergent. Apply with a soft cloth and allow to soak.

NOTE: The adhesive must be removed from all parts. It cannot be removed if it is baked on.

READ AND SAVE THESE INSTRUCTIONS

In Case of a Power Failure

In the event of a power failure, the oven is inoperable and no attempt should be made to operate it. However, the surface burners may be lit with a match. Using extreme caution, hold a lit match near the ports beneath

the surface burner cap, then slowly turn the knob to the LITE position. Once lit, surface burners will continue to operate normally.

Surface Burners

Lighting a Surface Burner

▲ WARNING Burners should be operated only when covered by cookware. Burner flames not covered by cookware present a risk of fire or clothing ignition. Never let flames extend beyond the sides of the cookware. Failure to comply may result in serious injury.

Make sure all burners are in their correct locations and fully assembled before attempting to operate any burner.

Select a burner and find its control knob. Push the knob in and turn it to the LITE position.

You will hear a clicking noise—the sound of the electric spark igniting the burner. When one burner is turned to LITE, all burners will spark. Sparking will continue as long as the knob remains at LITE. Once gas is ignited, turn the knob to adjust the flame size.

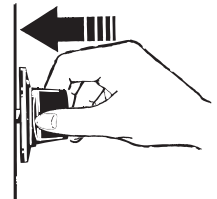

Push the control knob in and turn it to the LITE position.

Selecting a Flame Size

Watch the flame, not the knob, as you adjust heat. When rapid heating is desired, the flame size should match the size of the cookware you are using. Flames larger than the bottom of the cookware will not heat faster and may be hazardous.

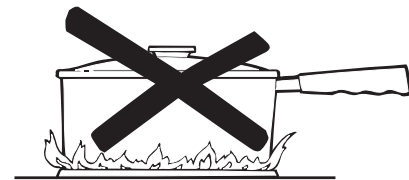

These flames are too large for the pot

Using the Surface Burners

NOTES:

- Do not operate the burner for an extended period of time without cookware on the grate. The finish on the grate may discolor or chip without cookware to absorb the heat.
- Do not attempt to disassemble any burner while another burner is on. Damage to the product may occur.
- Be sure the burners and grates are cool before you place your hand, a pot holder or cleaning materials on them.

Your rangetop has sealed gas burners that offer convenience, cleanability and flexibility for a wide range of cooking applications.

The smallest burner is the simmer burner. A simmer burner turned down to LO provides precise cooking performance for foods such as delicate sauces that require low heat for a long cooking time.

The extra-large burner is designed to quickly bring large amounts of liquid to a boil. Some models have a POWER BOIL™ setting especially designed for use with cookware with a diameter of 11 inches or larger.

Types of Surface Burners

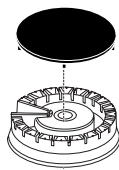

Round Burner

Use this burner for general cooking purposes. Size cookware appropriately to the flames.

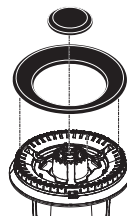

**Multi-Ring Burner
(on some models)**

Use this burner for large cookware or for simmering applications.



Oval Burner

Use this burner to cook on the griddle.

Surface Burners (Cont.)

Multi-Ring Burner (some models)

For large cookware, activate all rings by setting set the burner between Hi and Med.

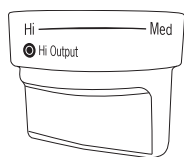

Side Views Of The Multi-Ring Burner Knob

For small cookware or low heating applications, only activate the inner rings by setting the burner between Lo and Sim.

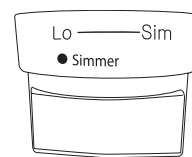

Top-of-Range Cookware

Aluminum: Medium-weight cookware is recommended because it heats quickly and evenly. Most foods brown evenly in an aluminum skillet. Use saucepans with tight-fitting lids when cooking with minimum amounts of water.

Stainless Steel: This metal alone has poor heating properties and is usually combined with copper, aluminum or other metals for improved heat distribution. Combination metal skillets usually work satisfactorily if they are used with medium heat or as the manufacturer recommends.

Cast-Iron: If heated slowly, most skillets will give satisfactory results.

Enamelware: Under some conditions, the enamel of some cookware may melt. Follow the cookware manufacturer's recommendations for cooking methods.

Glass: There are two types of glass cookware—those for oven use only and those for top-of-range cooking (saucepans, coffee and teapots). Glass conducts heat very slowly.

Heatproof Glass Ceramic: Can be used for either surface or oven cooking. It conducts heat very slowly and cools very slowly. Check the cookware manufacturer's directions to be sure it can be used on gas ranges.

Stove Top Grills

Do not use an after-market stove top grill on your gas surface burners. A stove top grill will cause incomplete combustion resulting in carbon monoxide levels above allowable standards. This could be hazardous to your health.



Do not use stove top grills

Using a Wok

Use only a flat-bottomed wok with a diameter of 14 inches or less. Make sure the wok bottom sits flat on the grate.

Do not use a wok support ring. Placing the ring over the burner or grate may cause the burner to work improperly, resulting in carbon monoxide levels above allowable standards. This could be hazardous to your health.



Use a flat-bottomed wok.



Griddle (on some models)

▲WARNING Fire Hazard

- Use care when cooking greasy foods. Spilled grease may result in fire.
- Never place any items on the griddle when it is not in use. Heat from surrounding burners can heat the griddle and may result in fire.
- Place and remove the griddle only when griddle is cool and all surface burners are turned OFF.

Using Your Cast Iron Griddle (on some models)

The ribbed side of the reversible griddle can be used for food normally grilled.

Your griddle provides an extra-large cooking surface for meats, pancakes and other foods usually prepared in a skillet. Before first use, rinse with hot water and dry thoroughly. Prepare the surface with cooking spray or vegetable oil.

Griddle Precautions:

- Do not place the griddle in a microwave oven.
- Do not clean your griddle in the dishwasher.
- If something has spilled under the griddle, it should be cleaned up as soon as possible to prevent “baked on” food soil.
- Do not allow grease to accumulate under the griddle as it can be a fire hazard. Clean under the griddle with hot, soapy water as soon as it is cool.

Positioning Your Griddle

The cast-iron griddle can only be used over the center burner(s) of the rangetop. To position the griddle, remove the center grate (if present), and replace it with the griddle. Do not turn on the center burner(s) until you are certain the griddle has been positioned correctly.

Preheating Your Griddle

With a reversible griddle, preheat your griddle by setting your center burner to Hi for 5-10 minutes before placing food on the griddle. Once the griddle is preheated, turn the knob on the burner(s) to the cook setting outlined in the table.

Preseasoned Reversible Cast-Iron Griddle

Type of Food	Cook Setting
Bacon	Med
Breakfast Sausage Links	Med
Eggs	Lo
Grilled Cheese	Med
Hamburgers	Med
Pancakes	Med
Warming Tortillas	Lo

Cook settings may need to be reduced if the griddle is used for an extended time.

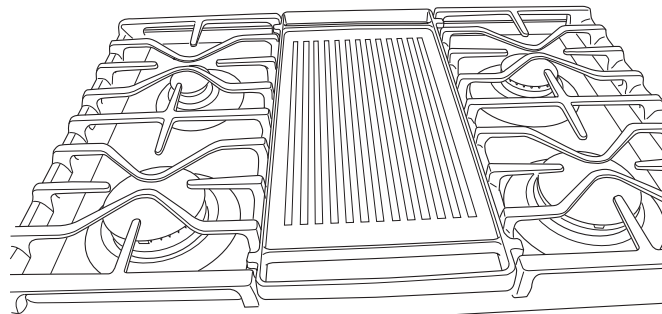

Replace the center grate with the reversible cast iron griddle

Griddle (on some models)

▲WARNING Fire Hazard

- Use care when cooking greasy foods. Spilled grease may result in fire.
- Never place any items on the griddle when it is not in use. Heat from surrounding burners can heat the griddle and may result in fire.
- Place and remove the griddle only when griddle is cool and all surface burners are turned OFF.

Using Your Nonstick Aluminum Griddle (on some models)

Your griddle provides an extra-large cooking surface for meats, pancakes, and other foods usually prepared in a skillet. Before first use, rinse with hot water and dry thoroughly.

Griddle Precautions:

- Do not use oil on the griddle for extended lengths of time. Permanent staining and/or craze lines on the surface could result.
- **Do not overheat the griddle.** Leaving the griddle burner on at Hi for an extended amount of time without food can damage the nonstick coating.
- Use only plastic, nylon, wooden utensils, or SilverStone® kitchen tools to prevent marring of the coating.
- Never use knives or cut food on the griddle.

- Do not use metal utensils with sharp points or rough, sharp edges which might damage the griddle surface.
- Store carefully to prevent scratching.
- Do not place the griddle in a microwave oven.
- If something has spilled under the griddle, it should be cleaned up as soon as possible to prevent “baked on” food soil.
- Do not allow grease to accumulate under the griddle as it can be a fire hazard. Clean under the griddle with hot, soapy water as soon as it is cool.
- Do not clean your griddle in the dishwasher.
- Do not clean the griddle in the self-cleaning oven. Doing so will damage the nonstick coating. For instructions on how to clean the griddle, see the Cleaning the Cooktop section of this manual.

Positioning Your Griddle

The nonstick aluminum griddle (on some models) can only be used over the center burner of the rangetop. To position the griddle, remove the center grate (if present), and replace it with the griddle. Do not turn on the center burner until you are certain the griddle has been positioned correctly.

Preheating Your Griddle

If your center burner is a single oval burner, preheat your griddle for 2-5 minutes on Hi before placing food on the griddle. If your center burner is a dual oval burner, preheat your griddle for 5-10 minutes on Hi before placing food on the griddle. Once the griddle is preheated, turn the heat down to the cook setting outlined in the table corresponding to your griddle. To determine the type of burner you have, see the Types of Surface Burners section.

Nonstick Aluminum Griddle

Type of Food	Cook Setting
Bacon	Med
Breakfast Sausage Links	Med
Fried Eggs	Lo
Hamburgers	Med-Hi
Hot Sandwiches (such as Grilled Cheese)	Med
Pancakes	Med-Lo
Warming Tortillas	Med-Lo

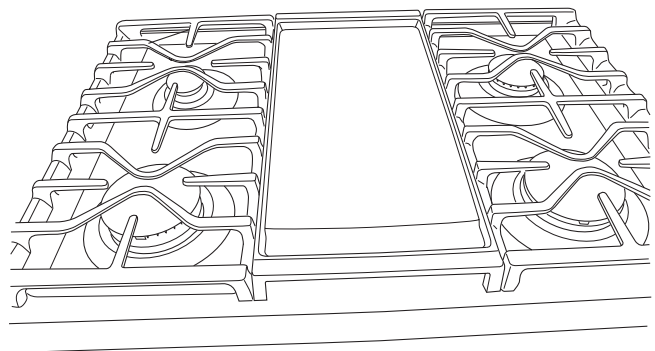

Replace the center grate (if present) with the Nonstick Aluminum Griddle

Oven Controls

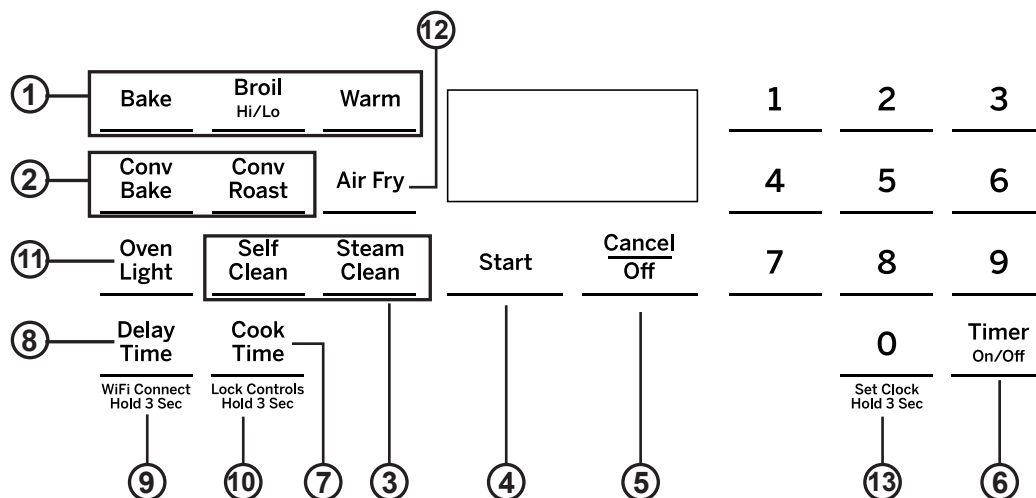

1. **Traditional Cooking Modes:** Your oven has the following traditional cooking modes: Bake, Broil and Warm. See the Oven Cooking Modes section for more information.
2. **Convection Cooking Modes (on some models):** Convection cooking mode uses increased air circulation to improve performance. See the Oven Cooking Modes section for more information.
3. **Clean:** Your oven has two cleaning modes: Self Clean and Steam Clean. See the Cleaning the Oven section for important information about using these modes.
4. **Start:** Must be pressed to start any cooking, cleaning, or timed function.
NOTE: If your display and keys dim, opening the oven door or pressing any key will wake and illuminate the control.
5. **Cancel/Off:** Cancels ALL oven operations except the clock and timer.
6. **Timer:** Works as a countdown timer. Press the **Timer** pad and use the number pads to program the time in hours and minutes. Press the **Start** pad. The oven will continue to operate when the timer countdown is complete. To turn the timer off, press the **Timer** pad.
7. **Cook Time:** Counts down cooking time and turns off the oven when the cooking time is complete. Select a desired cooking mode. Use the number pads to program a baking temperature. Press the **Cook Time** pad and use the number pads to program a cooking time in hours and minutes. Then press **Start**. This can only be used with **Bake, Convection Bake, Convection Roast, Warm, and Air Fry.**
8. **Delay Time:** Delays when the oven will turn on. Use this to set a time when you want the oven to start. Select a desired cooking mode. Use the number pad to program a baking temperature. Press the **Delay Time** pad. Use the number pads to program the time of day for the oven to turn on, and then press **Start**.
NOTE: When using the Delay Time feature, foods that spoil easily – such as milk, eggs, fish, stuffing, poultry, and pork – should not be allowed to sit for more than 1 hour before or after cooking. Room temperature promotes the growth of harmful bacteria. Be sure that the oven light is off because heat from the bulb will speed harmful bacteria growth.
9. **WiFi Connect (on some models):** Allows you to control your oven remotely. For instructions on how to connect your oven, see the WiFi Connect section in this manual.
10. **Lock Controls:** Locks out the control so that pressing the pads does not activate the controls. Press and hold the **Lock Controls** pad, for three seconds to lock or unlock the control. **Cancel/Off** is always active, even when the control is locked.
11. **Oven Light:** Turns the oven light on or off.
12. **Air Fry (on some models):** The Air Fry mode is designed to produce foods with a crispier exterior than traditional oven cooking. See the Oven Cooking Modes section for more information.
13. **Set Clock:** Set the oven clock time. Press the **Set Clock** pad. Use the number pads to program the clock. Press **Start** to save the time.

WiFi Connect

Your oven is designed to provide you with two-way communication between your appliance and smart device. By using the WiFi Connect features, you will be able to control essential oven operations such as temperature settings, timers and cooking modes using your smartphone or tablet.*

Select **Settings** then **Wifi** - follow the instructions on your oven display and phone app. It is necessary to turn on WiFi before using SmartHQ App on your oven.

Connecting your WiFi Connect Enabled Oven

What you will need

Your GE Appliances oven uses your existing home WiFi network to communicate between the appliance and your smart device. In order to setup your GE Appliances oven, you will need to gather some information:

1. Each GE Appliances oven has a connected appliance information label that includes an Appliance Network Name and Password. These are the two important details that you will need to connect to the appliance. The label is typically located inside the door of the oven or drawer.
2. Have your smart phone or tablet ready with the ability to access the internet and download apps.
3. You will need to know the password of your home WiFi router. Have this password ready while you are setting up your GE Appliances oven.

Connected Appliance Information

FCC: ZKJ-WCATA001	Network: GE_XXXXXX_XXXX
IC: 10229A-WCATA001	Password: XXXXXXXX
MAC ID: XX - XX - XX - XX - XX - XX	PT. NO. 229C6272G001-0

Sample Label





Connect your GE Appliances oven

1. On your smart phone or tablet visit **GEAppliances.com/connect** to learn more about connected appliance features and to download the SmrtHQ App.
2. Follow the app onscreen instructions to connect your GE Appliances oven.
3. Once the process is complete, the connection light located on your GE Appliances oven display will stay on solid and the app will confirm you are connected.
4. If the connection light does not turn on or is blinking, follow the instructions on the app to reconnect. If issues continue, please call the Connected Call Center 1.800.561.3344. and ask for assistance regarding oven wireless connectivity.

To connect additional smart devices, repeat steps 1 and 2.

Note that any changes or modifications to the remote enable device installed on this oven that are not expressly approved by the manufacturer could void the user's authority to operate the equipment.

REMOTE STARTING YOUR OVEN

To be able to start the oven remotely once connected to WiFi, make sure the  icon is visible in the display. The oven can now be remotely started with a connected device. Opening an oven door or turning off the oven will turn off the  icon. The  icon must be lit to start the oven remotely. The  icon is not required to change the oven temperature while it is running, set a timer or to turn the oven off from the phone app while the  icon shows it is Wifi Connected.

After using the oven, remember to verify that the  icon is lit if you wish to start the oven remotely in the future.

NOTE: Foods that spoil easily—such as milk, eggs, fish, stuffings, poultry and pork—should not be allowed to sit for more than 1 hour before or after cooking. Room temperature promotes the growth of harmful bacteria. Be sure that the oven light is off because heat from the bulb will speed harmful bacteria growth.

* Compatible Apple or Android devices and home WiFi network required.

Special Features

There are several different special features on your range. To change the settings of these special features:

- Press the **Bake** and **Broil** pads at the same time and hold until the special features menu is displayed.
- Use the **2** or **8** number pads to scroll through the special features until the desired feature is displayed.
- Press the **6** number pad to enter into the feature's menu and use the 2 or 8 number pads to scroll through the options.
- Once the desired option is displayed, press the **6** pad to save the setting and the **4** pad to exit the menu.

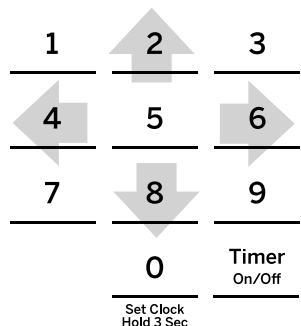

4 = Cancel/Back, 2 = Up, 8 = Down, 6 = Save/Forward

Adjust the Oven Temperature (OFSt)

This feature allows the oven baking temperature to be adjusted up to 35 hotter or down to 35 cooler. Use this feature if you believe your oven temperature is too hot or too cold and wish to change it. This adjustment affects every cooking mode except broil.

Enter into the special features menu as outlined above. Scroll through the features until "OFSt" is displayed and press **6**. Use the **2** pad to increase the adjusted temperature or use the **8** pad to decrease the adjusted temperature. Save and exit the special features menu.

End of Timer Signals (End tonE)

This is the tone that signals the end of a timer. The tone can be either continuous (Cont) or single (bEEp). The continuous setting (Cont) will repeatedly sound a tone every few seconds until a button on the control is pressed. A single setting (bEEp) will sound just a single tone at the end of the timer. Enter into the special features menu as outlined above. Scroll through the options until "End tonE" is displayed and press **6**. Scroll through the options until the desired setting is displayed. Press **6** to save the setting and then **4** to exit the menu.

Fahrenheit or Celsius Temperature Display (dEg Unit)

The oven control is set to use Fahrenheit temperatures (F), but you can change it to use Celsius temperatures (C). Enter into the special features menu as outlined above. Scroll through the options until "dEg Unit" is displayed and press **6**. Scroll through the options until the desired setting is displayed. Press **6** to save the setting and then **4** to exit the menu.

Clock Display (CLoc diSP)

This feature (On/Off) specifies if the time of day is displayed. Enter into the special features menu as outlined above. Scroll through the options until "Cloc

diSP" is displayed and press **6**. Scroll through the options until the desired setting is displayed. Press **6** to save the setting and then **4** to exit the menu.

Clock Configuration (Cloc cFg)

This feature specifies how the time of day will be displayed. You can select a standard 12-hour clock (12) or 24-hour military time display. Enter into the special features menu as outlined above. Scroll through the options until "Cloc cFg" is displayed and press **6**. Scroll through the options until the desired setting is displayed. Press **6** to save the setting and then **4** to exit the menu.

Sound Volume (Snd)

This feature allows the oven tone volume to be adjusted on and off. Enter into the special features menu as outlined above. Scroll through the options until "Snd" is displayed and press **6**. Scroll through the options until the desired setting is displayed. Press **6** to save the setting and then **4** to exit the menu. The selected sound option will play once **6** is pressed.

Auto Recipe Conversion

This feature (On/Off), automatically adjusts the programmed recipe temperature in Convection Multi-Bake mode. Enter into the special features menu as outlined above. Scroll through the options until "Auto rEciPE" is displayed. Scroll through the options until the desired setting is displayed. Press **6** to save the setting and then **4** to exit the menu.

NOTE: This option does not convert baking time, only temperatures. This option does not adjust temperatures for Convection Roast mode.

Remote Enable (App ENbl) (on some models)

Allows you to control your oven remotely (On/Off). Enter the special features menu as outlined above. Scroll through the options until "App ENbl" is displayed. Use **6** to enter the menu and toggle the setting using the 2 or 8 key. Press the 6 key to save the setting and then 4 to exit the menu.

12-Hour Auto Shut Off (12H Shut)

This feature turns off the oven after 12 hours of continuous operation (On/Off). Enter the special features menu as outlined above. Scroll through the options until "12H Shut" is displayed. Use 6 to enter the menu and toggle the setting using the 2 or 8 key. Press the 6 key to save the setting and then 4 to exit the menu.

Sabbath Mode - Enhanced

This range offers an enhanced Sabbath mode that complies with standards set forth by Orthodox Union, the Central Rabbinical Congress and Halacha Tech, and is 100% certified to the highest halacha standards. In order to enable the enhanced Sabbath mode, a separate Shabbos Keeper for Ovens must be connected to the range. The Shabbos Keeper can be purchased from zmantechnologies.com or geappliances.ca/en/. The only way to enable the enhanced Sabbath mode is with the purchase of the Shabbos Keeper for Ovens.



The Shabbos Keeper connects to your range to automatically enable Shabbos compatible modes each week and before every holiday. Using two modes, Shabbos mode and Holiday mode, the Shabbos Keeper allows for door openings and closings, disables most of the buttons on the appliance, and will adjust temperatures automatically during Shabbos and Yom Tov. The appropriate mode will automatically activate based on the Jewish calendar date for your location. Warming and baking features can be enabled when accepted by the user up to four hours in advance of Sabbath or holiday.

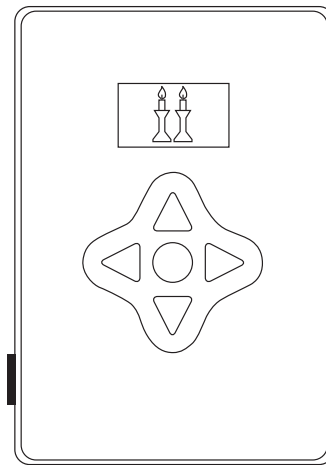

Shabbos Keeper

Sabbath Mode - Standard

This range offers a standard Sabbath mode*. Some of the Sabbath mode features that will be noticed by the consumer include the disabling of tones, disabling of oven lights, and delays of about 30 seconds to one minute between a request for a temperature change and its implementation. Only continuous baking or timed baking is allowed in the Sabbath mode. Cooking in the Sabbath mode is a two-step process, first the Sabbath mode must be set and then the bake mode must be set.

Setting the Sabbath Mode

1. Press and hold **Bake + Broil** to enter special features menu.
2. Use number key 8 to navigate to “Sabb” menu, Enter the menu using number key 6.
3. Use number key 8 again to toggle the setting to ON. Use number key 6 to confirm the setting.
4. Use number key 4 to exit Special features menu.
5. A single left opening bracket will appear.

Starting a Continuous Bake

1. Press the **Bake** pad.
2. If the desired temperature is 350°F, press **Start**. If a different cooking temperature is desired, use the **1** through **5** number pads or **Timer** pad to select a preset cooking temperature, then press **Start**. Refer to the graphic below to determine which pad sets the desired cooking temperature.

After a delay, a second bracket “]” [“ will appear in the display indicating that the oven is baking.

Temperature (°F)		
1	2	3
170	200	250
4	5	6
300	325	2h
7	8	9
2.5h	3h	3.5h
0		Timer On/Off
Set Clock Hold 3 Sec		400
4h		Lock Controls Hold 3 Sec
Time (hours)		6h

1 = 170° F, 2 = 200° F, 3 = 250° F, 4 = 300° F, 5 = 325° F, Timer = 400° F

6 = 2 hours, 7 = 2.5 hours, 8 = 3 hours, 9 = 3.5 hours,
0 = 4 hours, Lock Controls = 6 hours

Adjusting the Temperature

1. Press **Bake**, use the **1** through **5** number pads and the **Timer** pad to select a different preset cooking temperature, and press **Start**.
2. Since no feedback is given during temperature change, an oven thermometer can be used to confirm temperature changes.

Starting a Timed Bake

1. Press the **Bake** pad.
2. If the desired temperature is 350°F, use the **6** through **0** number pads or the **Lock Control** pad to select a cooking time. If a cooking temperature other than 350°F is desired, use the **1** through **5** number pads or the **Timer** pad to select a preset cooking temperature, then select the cooking time. Refer to the graphic on this page to determine which pad sets the desired cooking temperature and cooking time.
3. Press **Start**.

After a delay, a second bracket “]” [“ will appear in the display indicating that the oven is baking. When the cook time expires, the display will change back to a single bracket “[” indicating that the oven is no longer baking. No tone will sound when the cook time is complete.

Exit the Sabbath Mode

Exiting the Sabbath mode should be done after the Sabbath is over.

1. Press **Cancel/Off** to end any bake mode that may be running.
2. Press and hold **Bake + Broil** to enter special features menu.
3. Use number key 8 to navigate to “Sabb” menu, Enter the menu using num key 6.
4. Use number key 8 again to toggle the setting to OFF. Use number key 6 to confirm the setting.
5. Use number key 4 to exit Special features menu.

Sabbath Mode Power Outage Note

If a power outage occurs while the oven is in Sabbath Mode, the unit will return to Sabbath Mode when power is restored, however the oven will return to the off state even if it was in the middle of a bake cycle when the power outage occurred.

* The standard Sabbath mode has not been reviewed or approved by Orthodox Union.

Oven Racks

Recommended rack positions for various types of foods are provided in the Cooking Guide. Adjusting rack position is one way to impact cooking results. For example, if you would prefer darker tops on cakes, muffins, or cookies, try moving food one rack position higher. If you find foods are too brown on top try moving them down next time.

When baking with multiple pans and on multiple racks, ensure there is at least 1½" between pans to allow sufficient space for air to flow.

Your Oven may have extension racks and/or traditional flat racks.

To avoid possible burns, place the racks in the desired position before you turn the oven on.

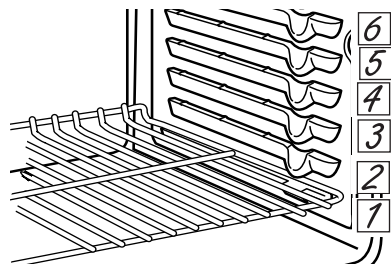

The number of rack positions may vary by model.

Aluminum Foil and Oven Liners

⚠ CAUTION Do not use any type of foil or oven liner to cover the oven bottom. These items can trap heat or melt, resulting in damage to the product and risk of shock, smoke or fire. Damage from improper use of these items is not covered by the product warranty.

Foil may be used to catch spills by placing a sheet on a lower rack, several inches below the food. Do not use more foil than necessary and never entirely cover an oven rack with aluminum foil. Keep foil at least 1-1/2" from oven walls to prevent poor heat circulation.

Oven Cooking Modes

Your new oven has a variety of cooking modes to help you get the best results. These modes are described below. Refer to the Cooking Guide section for rack position and other recommendations for specific modes and foods.

Bake

The traditional bake mode is intended for single rack cooking. This mode uses heat primarily from the lower element but also from the upper element to cook food. Preheating is generally recommended when using this mode. To use this mode press the **Bake** pad, enter a temperature with the number pads, and then press **Start**.

Convection Bake

This mode is intended for single rack baking when additional airflow is desired to enhance evenness. Preheating is generally recommended when using this mode. To use this mode press the **Conv Bake** pad, enter a temperature with number pads, and then press **Start**.

Convection Roast

This mode is intended for roasting whole cuts of meat on a single rack. The utilization of all three elements and direct airflow down from the top of the oven improves browning and reduces cooking time. Check food earlier than the recipe suggests or use the probe when using this mode. To use this mode press the **Conv Roast** pad, enter a temperature with number pads, and then press **Start**.

Broiling Modes

Always broil with the door closed. The broil element in this oven is very powerful. Monitor food closely while broiling. Use caution when broiling on upper rack positions as placing food closer to the broil element increases smoking, spattering, and the possibility of fats igniting. Broiling on rack position 6 is not recommended.

Broiling can be used for foods that would typically be grilled.

Adjust the rack position in order to vary the intensity of the heat to the food. Place foods closer to the broil element when a seared surface and rare interior are desired. For best performance center the food below the broil heating element.

Press the **Broil** pad twice for High or once for Low depending on the amount of searing and the internal temperature that is preferred. The High setting is best for thinner cuts of meat and/or foods you prefer less done on the interior. The Low setting is preferred for thicker cuts of meat and foods you like to be cooked all the way through. It is not necessary to preheat the oven for these modes. Then press **Start**.

Air Fry

Air Fry is a special, no-preheat, cooking mode that is designed to produce foods with a crispier exterior than traditional oven cooking. The Air Fry mode is intended for single rack cooking only. Select **Air Fry**, then input the desired set temperature and press **Start**. The temperature can be set between 300°F and 500°F. Preheating is not recommended for this mode. Follow traditional oven recipe or package guidelines for set temperatures and cook times; adjust cook time to achieve your desired crispness. Additional guidelines for using this mode can be found in the Cooking Guide.

Warm

Warm mode is designed to keep hot foods at a higher temperature for up to 3 hours. Preheating is not required. Do not use warm to heat cold food other than crisping crackers, chips, or dry cereal. It is also recommended that food not be kept warm for more than 2 hours. Press the **Warm** pad and then press **Start**.

Oven Air Vents

Never block the vents (air openings) of the range. They provide the air inlet and outlet that are necessary for the range to keep cool and operate properly with correct combustion.

Air openings are located at the rear of the cooktop, at the top and bottom of the oven door, and at the bottom of the range.

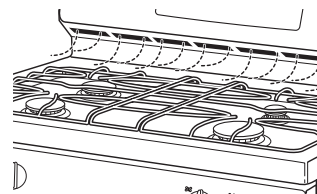

Vent appearance and location vary.

Oven Cooking Guide

Cook food thoroughly to help protect against food borne illness. Minimum safe food temperature recommendations for food safety can be found at IsItDoneYet.gov. Use a food thermometer to measure food temperatures.

Oven Cookware Guidelines

The material, finish, and size of cookware affect baking performance.

Dark, coated and dull pans absorb heat more readily than light, shiny pans. Pans that absorb heat more readily can result in a browner, crisper, and thicker crust. If using dark and coated cookware check food earlier than minimum cook time. If undesirable results are obtained with this type of cookware consider reducing oven temperature by 25°F next time.

Shiny pans can produce more evenly cooked baked goods such as cakes and cookies.

Glass and ceramic pans heat slowly but retain heat well. These types of pans work well for dishes such as pies and custards.

Air insulated pans heat slowly and can reduce bottom browning.

Keep cookware clean to promote even heating.

Stoneware heats slowly and retains heat well. It is recommended to preheat this type of cookware if possible. Additional cook time may be required.

Cookware used in broil modes and air fry must be broil-safe.

Oven Cooking Guide

FOOD TYPE	RECOMMENDED MODE(S)	RECOMMENDED RACK POSITION(S)	ADDITIONAL SUGGESTIONS
Baked Goods			
Layer cakes, sheet cakes, bundt cakes, muffins, quick breads on a Single Rack	Bake	3	Use shiny cookware.
Layer cakes* on Multiple Racks	Bake Convection Bake	3 and 5	Use shiny cookware. Ensure adequate airflow (see illustration below).
Chiffon cakes (angel food)	Bake	1	Use shiny cookware.
Cookies, biscuits, scones on a Single Rack	Bake	4	Use shiny cookware.
Cookies, biscuits, scones on Multiple Racks	Convection Bake	3 and 5 2, 4, 6	Use shiny cookware. Ensure adequate airflow.
Yeast Breads	Bake	3 or 4	
Beef & Pork			
Hamburgers	Broil High	6	Use a broil pan; move food down for more doneness/less searing. Watch food closely when broiling. For best performance center food below the broil heater.
Steaks & Chops	Broil High	6 or 5	Use a broil pan; move food down for more doneness/less searing. Watch food closely when broiling. For best performance center food below the broil heater.
Roasts	Bake Convection Roast	2 or 3	Use a low sided pan such as a broil pan. Preheating is not necessary.
Poultry			
Whole chicken	Bake Convection Roast	2 or 3	Use a low sided pan such as a broil pan. Preheating is not necessary.
Bone-in chicken breasts, legs, thighs	Broil Low Bake	3	If breaded or coated in sauce avoid Broil High modes. Broil skin side down first. Watch food closely when broiling. For best performance when broiling, center food below the broil heater.
Boneless chicken breasts	Broil Low Bake	3	Move food down for more doneness/less searing and up for greater searing/browning when broiling. For best performance when broiling, center food below the broil element or burner.
Whole turkey	Bake Convection Roast	1	Use a low sided pan such as a broil pan. Preheating is not necessary.
Turkey Breast	Bake Convection Roast	3	Use a low sided pan such as a broil pan. Preheating is not necessary.
Fish	Broil Low	6 (1/2 inch thick or less) 5 (>1/2 inch)	Watch food closely when broiling. For best performance center food below the broil heater.
Casseroles	Bake	3 or 4	
Frozen Convenience Foods			
Single Rack	Bake	4	Place food in oven prior to starting mode. Use dark cookware for more browning/crisping; use shiny cookware for less browning.
Multiple Racks	Convection Bake	3 and 5	Use dark cookware for more browning/crisping; use shiny cookware for less browning. For multiple racks of pizzas, stagger left to right, do not place directly over each other.

*When baking four cake layers at a time use racks 3 and 5. Place the pans as shown so that one pan is not directly above another.

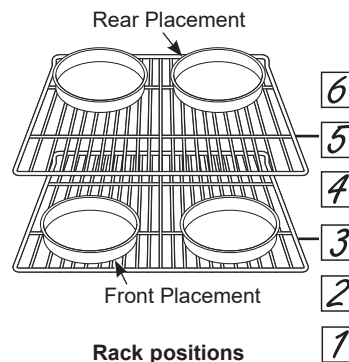

Oven Cooking Guide

Air Fry Cooking Guide

Air Fry is a special, no-preheat, cooking mode that is designed to produce foods with a crispier exterior than traditional oven cooking. Select **Air Fry**, then input the desired set temperature and press **Start**. The temperature can be set between 300°F and 500°F.

Air Fry Cookware Guidelines

- Only use broil safe cookware when using Air Fry mode.
- A dark sheet pan is recommended. A dark pan promotes better browning and crisping.
- Oven baking baskets and baking grids can also be used. A sheet pan should be placed on the rack below the foods to catch any drippings when using a baking basket.

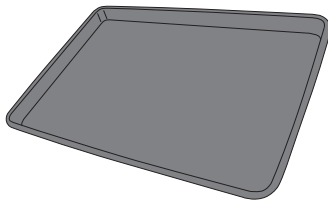

Primary recommended cookware

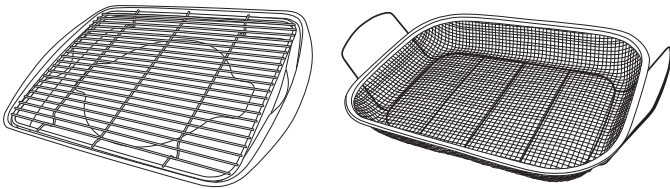

Alternate cookware options

General Tips for Air Fry Mode

- The Air Fry mode is designed for cooking on a single rack.
- The Air Fry mode is designed to be used without preheating.
- Rack position 4 is recommended for most foods. Use rack position 3 for thicker foods.
- Foods may cook faster than expected if the oven is already hot when food is placed in the oven.
- When air frying foods with sauce, it is recommended to apply the sauce at the end of cooking.
- If foods are browning too quickly, try a lower rack position or lower oven set temperature.
- For packaged foods, use traditional oven cooking instructions for set temperature and expected cook time.
- It is not necessary to flip or stir food during cooking
- Arrange food in a single layer on the pan, do not overload the pan.
- Always check internal food temperature to confirm minimum safe temperatures have been reached. Minimum safe food temperatures can be found on packages and at IsItDoneYet.gov.

FOOD TYPE	RECOMMENDED RACK POSITION(S)	RECOMMENDED SET TEMPERATURES (F°)	RECOMMENDED COOK TIME (MIN)	NOTES
Fresh boneless fish or poultry pieces, breaded such as nuggets, tenders, fillets	4	375-400	15-30	User lower set temperatures for larger pieces. Use shiny cookware.
Fresh bone in chicken wings	4	375-400	25-40	Salt wings or coat in a dry rub, if using sauce apply after cooking or toward the end of cooking
Fresh bone in chicken drumsticks or thighs	3 or 4	375-400	30-55	User lower set temperatures for larger pieces.
Fresh French fries, thin (< ½ inch)	4	400-425	15-30	Parchment paper is recommended when preparing fresh French fries. For crispier fries, toss fries in corn starch or rice flour before cooking.
Fresh French fries, thick (> ½ inch)	3 or 4	375-400	20-35	Parchment paper is recommended when preparing fresh French fries. For crispier fries, toss fries in corn starch or rice flour before cooking.
Frozen packaged foods	3 or 4 (use rack position 3 for thicker foods)	Use traditional oven(not Air Fry) cooking instructions as a guideline for set temperature and cook time. Additional cook time beyond recommended package time may be required for some foods. If oven is hot when starting, food may cook faster than the minimum package time.		

Range – Exterior

Be sure all controls are off and all surfaces are cool before cleaning any part of the range.



⚠ WARNING

If your range is removed for cleaning, servicing or any reason, be sure the anti-tip device is reengaged properly when the range is replaced. Failure to take this precaution could result in tipping of the range and can result in death or serious burns to children or adults.

Control Lockout

If desired, the touch pads may be deactivated before cleaning.

See Lock Controls in the Oven Controls section in this manual.

Clean up splatters with a damp cloth.

You may also use a glass cleaner.

Remove heavier soil with warm, soapy water. Do not use abrasives of any kind.

Reactivate the touch pads after cleaning.

Control Panel

It's a good idea to wipe the control panel after each use. Clean with mild soap and water or vinegar and water, rinse with clean water and polish dry with a soft cloth.

Do not use abrasive cleansers, strong liquid cleansers, plastic scouring pads or oven cleaners on the control panel—they will damage the finish, including Black Stainless Steel.

Oven Exterior

Do not use oven cleaners, abrasive cleansers, strong liquid cleansers, steel wool, plastic scouring pads, or cleaning powders on the interior or exterior of the oven. Clean with a mild soap and water or vinegar and water solution. Rinse with clean water and dry with a soft cloth. When cleaning surfaces, make sure that they are at room temperature and not in direct sunlight.

If stain on the door vent trim is persistent, use a mild abrasive cleaner and a sponge-scrubber for best results.

Spillage of marinades, fruit juices, tomato sauces and basting liquids containing acids may cause discoloration and should be wiped up immediately. Let hot surfaces cool, then clean and rinse.

Painted Surfaces

Painted surfaces include the sides of the range and the door, top of control panel and the drawer front. Clean these with soap and water or a vinegar and water solution.

Do not use commercial oven cleaners, cleaning powders, steel wool or harsh abrasives on any painted surface, including Black Stainless Steel.

Stainless Steel excluding Black Stainless Steel (on some models)

Do not use a steel wool pad; it will scratch the surface.

Cleaners with oxalic acid such as Bar Keepers Friend Soft Cleanser™ will remove surface rust, tarnish and small blemishes. Use only a liquid cleanser free of grit and rub in the direction of the brush lines with a damp, soft sponge.

To clean the stainless steel surface, use warm sudsy water or a stainless steel cleaner or polish. Always wipe the surface in the direction of the grain. Follow the cleaner instructions for cleaning the stainless steel surface.

To inquire about purchasing cleaning products including stainless steel appliance cleaner or polish, see the Accessories and Consumer Support sections at the end of this manual.

Range – Interior

The interior of your new oven can be cleaned manually or by using Steam Clean or Self Clean modes.

Spillage of marinades, fruit juices, tomato sauces and basting liquids containing acids may cause discoloration and should be wiped up immediately. Let hot surfaces cool, then clean and rinse.

Manual Cleaning

Do not use oven cleaners, strong liquid cleansers, steel wool, or scouring pads on the interior of the oven. For soils on the oven bottom and other enameled surfaces, use a gentle abrasive containing oxalic acid, such as Bar Keepers Friend®, with a non-scratch sponge. Take care not to apply any abrasive cleaners or sponges to

the door glass, as it will scratch the reflective coating. The oven interior and door glass may be cleaned using a soft cloth with a mild soap and water, or vinegar and water solution. After cleaning, rinse with clean water and dry with a soft cloth.

Steam Clean Mode (on some models)

The Steam Clean feature is for cleaning light soil from your oven at a lower temperature than Self Clean.

To use the Steam Clean feature:

1. Start with the oven at room temperature.
2. Wipe excess grease and soils from the oven.
3. Pour one cup of water onto the bottom of the oven.
4. Close the door.
5. Press the **Clean** pad, select **Steam Clean** and then press **Start**.

Do not open the door during the 30 minute Steam Clean cycle. At the end of the Steam Clean cycle, soak up the remaining water, and wipe the moisture-softened soil from the oven walls and door.

Self Clean Mode

Read Self-Cleaning Oven Safety Instructions at the beginning of this manual before using the Self Clean Mode. Self Clean uses very high temperatures to clean the oven interior. For a moderately soiled oven, run a 3 hour self-clean cycle. For a heavily soiled oven, run a 5 hour self-clean cycle. Only self-clean (black) racks and grates may remain in the oven during the self-clean cycle. All other items, including nickel plated (silver) racks, should be removed. If nickel plated (silver) racks are left in the oven during a self-clean cycle, the racks will tarnish. If either type of rack is left in the oven during a self-clean cycle, the rack may become difficult to slide. See the Oven Racks section for instructions on how to improve.

IMPORTANT: The health of some birds is extremely sensitive to the fumes given off during the self-cleaning cycle of any range. Move birds to another well-ventilated room.

To use the Self Clean feature:

1. Start with the oven at room temperature.
2. Wipe excess grease and soils from the oven and interior door.
3. Remove all items other than self-clean (black) racks and grates, if desired. See Cleaning the Cooktop to determine if your grates may be self-cleaned and for important details regarding grate placement.
4. Close the door.
5. Press the **Clean** pad, select **Self Clean** and then press **Start**.

You cannot open the door during the self-clean cycle. The door will remain locked after the self-clean cycle until the oven cools below the unlocking temperature. At the end of the self-clean cycle, allow the oven to cool and wipe any ash out of the oven.

Racks

All racks can be washed with warm, soapy water. Enameled (not shiny) racks can be left in the cavity during self clean.

Racks may be more difficult to slide, especially after a self-clean. Put some vegetable oil on a soft cloth or paper towel and rub onto the left and right edges.

Cooktop

Removal of Surface Burners for Cleaning

Turn all controls OFF. Allow cooktop to cool before removing grates and burner parts. When removing the burner caps and heads, remember their size and location. Replace them in the same location after cleaning.

CAUTION Do not attempt to remove oval burner cap from the burner heads.

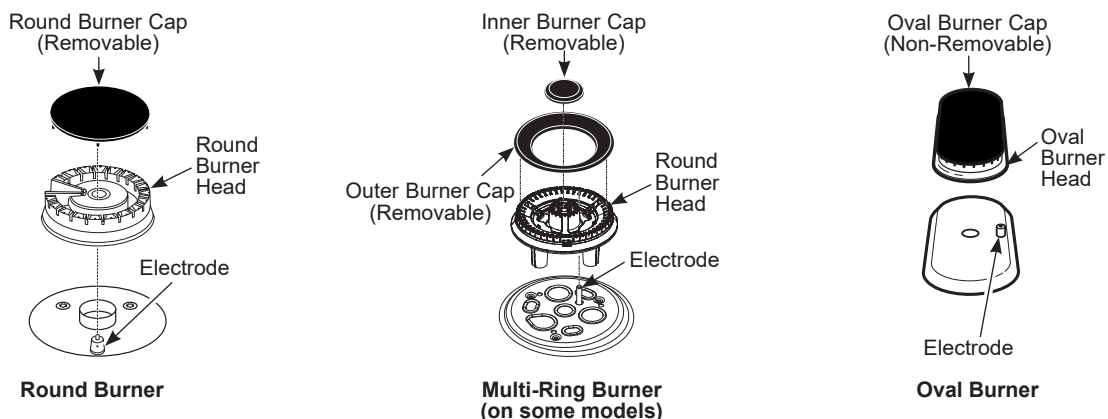

Cleaning the Surface Burners

Cleaning the Burner Caps

Wash burner caps in hot, soapy water and rinse with clean water. You may scour with a plastic scouring pad to remove burned-on food particles. The round burner caps may also be cleaned in your dishwasher.

Cleaning the Burner Heads

Wash the burner heads routinely, especially after bad spillovers which could clog the burner openings. Lift burners off when cool. Wash with hot, soapy water. Rinse with clean water. For more stubborn stains, use a brush with plastic bristles.

NOTE: Do not use steel wool or scouring pads to clean the burner parts as these may clog the openings. Never wash burner heads in your dishwasher as dishwasher. Doing so may cause them to discolor.

The ports in the burner heads must be kept clean at all times for an even, unhampered flame.

Clogged or dirty burner ports or electrodes will not allow the burner to operate properly.

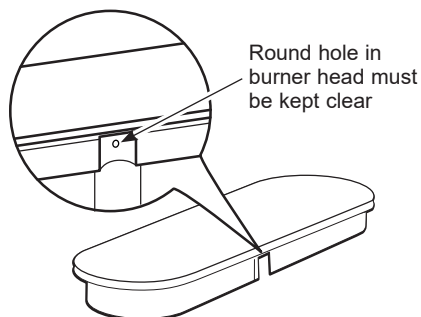

Replacing Surface Burners

Before replacing the burner caps, heads and oval head/cap assembly, shake out excess water and allow them to dry thoroughly.

Replace burner heads in the correct locations according to size. Ensure each cap is properly seated on the burner head, as pictured below.



CAUTION Do not operate the cooktop without all burner parts and grates in place.

Any spill on or around an electrode must be carefully cleaned. Avoid hitting the electrode with anything hard or it could be damaged.

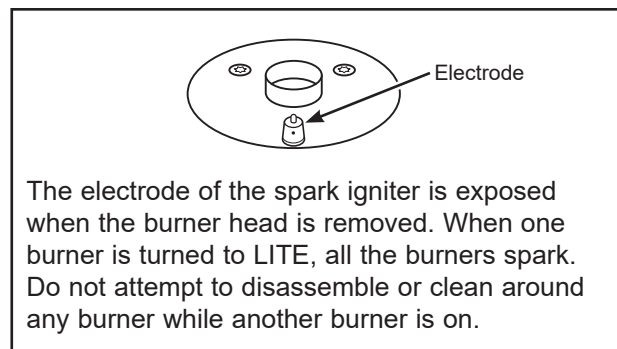

Cooktop (Cont.)

Burner Grates

Manual Cleaning

Grates should be washed in hot, soapy water and rinsed with clean water. To soften burned-on food, place grates in a solution containing ¼-cup of household ammonia for several hours. Afterward, scrub grates with a plastic scouring pad soaked in hot, soapy water. Rinse well and dry.

Self Clean Mode

If your grates do not have rubber bumpers on their bottom surface, they may be cleaned in the oven using the self-clean cycle. Do not attempt to clean your grates in the oven if your grates have rubber bumpers. Doing so will destroy the rubber bumpers and may affect the function of your surface burners.

Porcelain-coated grates may gradually dull if continually exposed to self-clean temperatures.

If your oven is equipped with self-clean (black) racks, it is recommended to follow the instructions for placing grates on racks. If your oven is equipped with nickel-plated (silver) racks, it is recommended to follow the instructions for placing grates on the oven bottom. Nickel-plated racks should not remain in the oven during the self clean cycle. Doing so will tarnish the racks. If either type of rack is left in the oven during a self-clean cycle, the rack may become difficult to slide.

NOTE: When placing or removing grates from the oven, do not slide the grates on the racks or oven bottom. Doing so could damage the enamel on the racks or oven bottom.

To self-clean your grates on self-clean racks:

1. Insert racks in positions 1, 3, and 5 or positions 2 and 4.
2. Gently place one grate on each rack.

NOTE: DO NOT operate your cooktop during the Self Clean Mode because the Self Clean cycle will be canceled.

To self clean your grates on the oven bottom:

1. Remove all oven racks.
2. Gently place one grate on the center of the oven bottom with the grate oriented in the upright position. Stack remaining grate(s) as shown below. Do not place or stack grates in any other configuration.

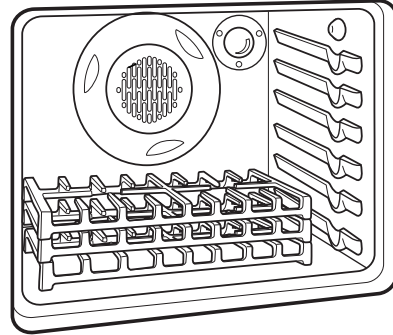

Once the grates are placed in the oven, operate the self-clean cycle per the instruction in the Cleaning the Oven section.

NOTE: Use caution when removing the grates from the oven after the self-clean cycle has ended. The grates may still be hot.

Once the self-clean cycle is complete, the grates may carefully be removed. You may notice a white residue on the grates. Wipe it off with a damp sponge. If white spots persist, wet the sponge with a 50/50 solution of vinegar and water and wipe the grates again.

When replacing the grates on the cooktop, be sure to locate them correctly. Grates should fit securely into the cooktop.

Grate Support Bumpers (on some models)

If any of the rubber grate support bumpers in the cooktop are missing or damaged, replacement parts can be obtained by calling GE Appliances at 1-800-661-1616

To insert the new bumpers, simply place the cone-shaped end of the bumper into the hole in the cooktop and push down while gently twisting the bumper.

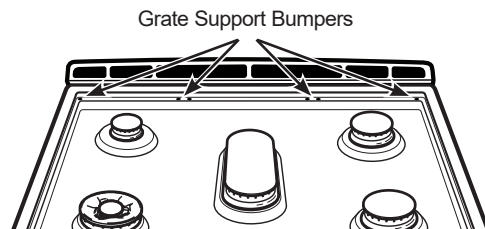

Griddles

Aluminum and Reversible Cast-Iron: Clean your reversible cast-iron griddle with a stiff brush and hot water. Using soap is not recommended, and harsh detergents should never be used as they will remove the seasoning. Rinse with hot water and dry thoroughly. After rinsing, preseason the griddle by applying a light coat of cooking oil to the griddle surface. Wipe off excess oil with a paper towel.

Store in a cool, dry place.

Griddle Precautions:

- If something has spilled under the griddle, it should be cleaned up as soon as possible to prevent the spill from getting baked onto the cooktop.
- Do not allow grease to accumulate under the griddle as it can be a fire hazard. Clean under the griddle with hot, soapy water as soon as it is cool.
- Do not wash your griddle in the dishwasher.
- Do not clean the griddle in the self-cleaning oven.

Door and Drawer

Cleaning the Oven Door

Cleaning the Door Interior

Do not allow excess water to run into any holes or slots in the door.

Wipe dish soap over any baked-on spatters on the glass. Use a single sided safety razor blade to clean it off. Then wipe over the glass with a soapy cloth to remove any residue and dry off.

The area outside the gasket can be cleaned with a soap-filled plastic scouring pad. Do not rub or clean the door gasket - it has an extremely low resistance to abrasion.

If you notice the gasket becoming worn, frayed or damaged in any way or if it has become displaced on the door, you should have it replaced.

Cleaning the Door Exterior

If a stain on the door vent trim is persistent, use a mild abrasive cleaner and a sponge-scrubber for best results. Do not use this method on any other surface.

Stainless Steel Surfaces (on some models)

Do not use a steel wool pad; it will scratch the surface.

To clean the stainless steel surface, use warm sudsy water or a stainless steel cleaner or polish. Always wipe the surface in the direction of the grain. Follow the cleaner instructions for cleaning the stainless steel surface.

To inquire about purchasing cleaning products including stainless steel appliance cleaner or polish, see the Accessories and Consumer Support sections at the end of this manual.

Removable Storage Drawer

Most cleaning can be done with the drawer in place. However, the drawer may be removed if further cleaning is needed. Use soap and warm water to thoroughly clean.

To remove the drawer:

1. Pull drawer straight out until it stops.
2. Press the left rail release up and press the right rail release down, while pulling the drawer forward and free.

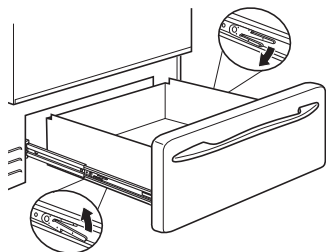

To replace the drawer:

1. Place the left drawer rail around the inner left rail guide and slide it in slightly to hook it.
2. Place the right drawer rail around the inner right rail guide and slide it in slightly to hook it.
3. Slide the drawer all the way in.

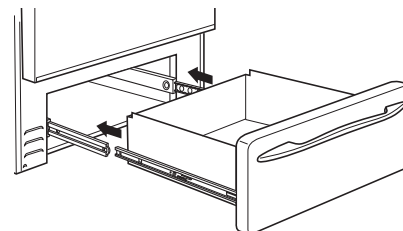

Oven Light

⚠ WARNING SHOCK OR BURN HAZARD: Before replacing oven light bulb, disconnect the electrical power to the range at the main fuse or circuit breaker panel. Failure to do so may result in electric shock or burn.

⚠ CAUTION BURN HAZARD: The glass cover and bulb should be removed when cool. Touching hot glass with bare hands or a damp cloth can cause burns.

NOTE: The glass cover should be removed only when cool. Wearing latex gloves may offer a better grip.

Before replacing the bulb, disconnect electrical power to the oven at the main fuse or circuit breaker panel. Let the bulb cool completely before removing it. For your safety do not touch a hot bulb with a damp cloth. If you do the bulb may break.

To remove:

Turn the glass cover counterclockwise 1/4 turn until the tabs of the glass cover clear the grooves of the socket and pull the cover off. Remove the bulb.

To replace:

Put in a new 40-watt appliance bulb. Place the tabs of the glass cover into the grooves of the socket. Turn the glass cover clockwise 1/4 turn.

NOTE:

- A 40-watt appliance bulb is smaller than a standard 40-watt household bulb.
- Reconnect electrical power to the oven once the new bulb is installed.
- For improved lighting inside the oven, clean the glass cover frequently using a wet cloth. This should be done when the oven is completely cool.

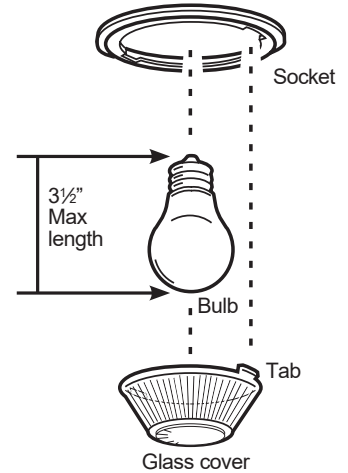

⚠ CAUTION Before replacing your oven light bulb, disconnect the electrical power to the range at the main fuse or circuit breaker panel. Be sure to let the light cover and bulb cool completely.

The oven light bulb is covered with a removable glass cover that is held in place with a bail-shaped wire. Remove the oven door, if desired, to reach the cover easily. See the Lift-Off Oven Door section for detailed oven door removal instructions.

Replacing the Light Bulb:

1. Disconnect electrical power to the range.
2. Hold the glass cover stable, so it doesn't fall when released.
3. Slide near the indent of the cover holder until the cover is released. **Do not remove any screws to release the glass cover.**
4. Replace bulb with a 40-watt household appliance bulb. **Do not touch hot bulb with hand or wet cloth. Only remove bulb when it is cool.**
5. Hold glass cover stable over new bulb.
6. Pull the wire cover holder near the indent until the indent in the wire cover holder is located in the indent of the glass cover.
7. Connect electrical power to range.

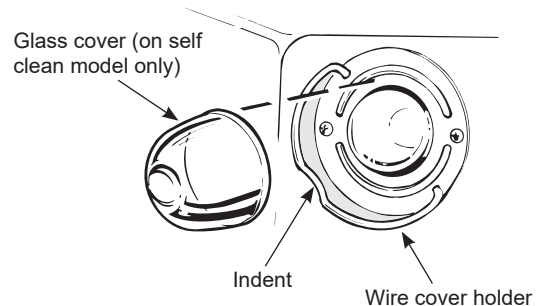

Oven Door

The door is very heavy. Be careful when removing and lifting the door. Do not lift door by the handle.

To Remove the Door:

1. Fully open the door.
2. Pull the hinge locks up and away from the range frame to the unlocked position.
3. Firmly grasp both sides of the door near the top.
4. Close door until the top of the door is approximately 6" from the range frame.
5. Lift door up and away from the range until both hinge arms are clear of the slots in the range frame.

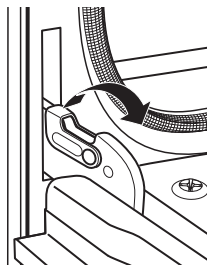

Pull hinge locks up to unlock

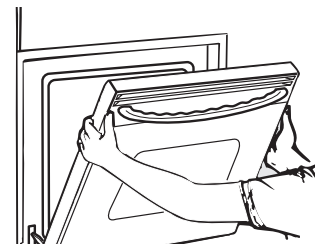

Removal position

To Replace the Door:

1. Firmly grasp both sides of the door near the top.
2. With the door at the same angle as the removal position, rest the notch on the underside of the left hinge arm on the bottom edge of the left hinge slot. The notch in the hinge arm must be fully seated into the bottom of the slot. Repeat for the right side.
3. Fully open the door. If the door will not fully open, the notches in the bottoms of the hinge arms have not seated correctly in the bottom edge of the slot. Lift the door off the range and repeat previous step.
4. Push the hinge locks toward the range cavity and down to the locked position.
5. Close the oven door.

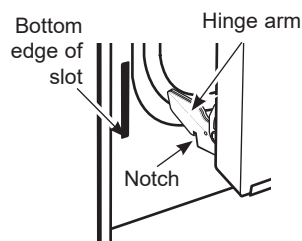

Rest notch on bottom edge of hinge slot

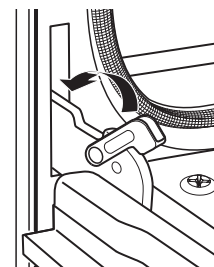

Push hinge locks down to lock

Troubleshooting Tips ... Before you call for service

Save time and money! Review the charts on the following pages first and you may not need to call for service.

Problem	Possible Cause	What To Do
My new oven doesn't cook like my old one. Is something wrong with the temperature settings?	Your new oven has a different cooking system from your old oven and therefore may cook differently than your old oven.	For the first few uses, follow your recipe times and temperatures carefully and use rack positions recommended in the Cooking Guide. If you still think your new oven is too hot or too cold, you can adjust the temperature yourself to meet your specific cooking preference. See the Settings section.
Food does not bake properly	Oven controls improperly set.	See the Cooking Modes section.
	Rack position is incorrect or rack is not level.	See the Cooking Modes section and Cooking Guide.
	Incorrect cookware or cookware of improper size being used.	See the Cookware section.
	Oven temperature needs adjustment.	See the Settings section.
Food does not broil properly	Oven controls improperly set.	Make sure you select the appropriate broil mode.
	Improper rack position being used.	See Cooking Guide for rack location suggestions.
	Cookware not suited for broiling.	Use a pan specifically designed for broiling.
	Aluminum foil on the broil pan has not been fitted properly or slit to drain grease.	If using aluminum foil on broil pan, wrap tightly and add slits conforming to those in the pan to allow grease to drain.
Oven temperature too hot or too cold	Oven temperature needs adjustment.	See the Oven Controls section.
Oven and/or display appears not to work	A fuse in your home may be blown or the circuit breaker tripped.	Replace the fuse or reset the circuit breaker.
	Oven controls improperly set.	See the Using the Oven section.
	Oven is in Sabbath Mode.	Verify, that the oven is not in Sabbath Mode. See the Sabbath Mode section.
	The clock is turned off.	See the Settings section.
"Crackling" or "popping" sound	This is the sound of the metal heating and cooling during both the cooking and cleaning functions.	This is normal.
Why is my range making a "clicking" noise when using my oven?	Your range has been designed to maintain a tighter control over your oven's temperature. You may hear your oven's heating elements "click" on and off more frequently than in older ovens to achieve better results during baking, broiling, and self-clean cycles.	This is normal.
Sometimes the oven takes longer to preheat to the same temperature	Cookware, food, and/or number of racks in oven.	Cookware, food, and racks in the oven will cause differences in preheat times. Remove excess items to reduce preheat time.

Troubleshooting Tips ... Before you call for service

Problem	Possible Cause	What To Do
Oven light does not work	Light bulb is loose or defective.	Tighten or replace bulb. See the Maintenance section for instructions on how to replace the bulb.
Oven will not self-clean	The temperature is too high to set a self-clean operation.	Allow the oven to cool and reset the controls.
	Oven controls improperly set.	See the Cleaning the Oven section.
Excessive smoking during clean cycle	Excessive soil or grease.	Press the Cancel/Off pad. Open the windows to rid the room of smoke. Wait until the LOCKED light goes off. Wipe up the excess soil and reset the clean cycle.
Oven not clean after a clean cycle	Oven controls improperly set.	See the Cleaning the Oven section.
	Oven was heavily soiled.	Clean up heavy spillovers before starting the clean cycle. Heavily soiled ovens may need to self-clean again or for a longer period of time.
Strong “burning” or “oily” odor emitting from the vent	This is normal in a new oven and will disappear in time.	To speed the process, set a self-clean cycle for a minimum of 3 hours. See the Cleaning the Oven section. This is temporary.
Excessive smoking during broiling	Food too close to burner element.	Lower the rack position of the food.
Oven door will not open or LOCKED light is on when you want to cook.	The oven door is locked because the temperature inside the oven has not dropped below the locking temperature.	Press the Cancel/Off pad. Allow the oven to cool below the locking temperature.
"LOCK DOOR" flashes in the display	The self-clean cycle has been selected but the door is not closed.	Close the oven door.
"F— and a number or letter" flash in the display	You have a function error code.	Press the Cancel/Off pad. Allow the oven to cool for one hour. Put the oven back into operation. If the function code repeats, disconnect all power to the oven for at least 30 seconds and then reconnect power. If the function error code repeats again, call for service.
Power outage, clock flashes	Power outage or surge	Reset the clock. If the oven was in use, you must reset it by pressing the Cancel/Off pad, setting the clock and resetting any cooking function.
Lock Controls or Control Lockout feature is activated		If LOC ON appears in the display, the range control is locked. Turn this feature off to use the range. See the Lock Control feature in the Oven Controls section.
Burners do not light	Plug on range is not completely inserted in the electrical outlet.	Make sure electrical plug is plugged into a live, properly grounded outlet.
	Gas supply not connected or turned on.	See the Installation Instructions that came with your range.
	A fuse in your home may be blown or the circuit breaker tripped.	Replace the fuse or reset the circuit breaker.
	Burner parts not replaced correctly.	See the Care and Cleaning of the range section.
	Burner slots near the electrode, or the round lighter port on the oval burner, may be clogged.	Remove the burners and clean them. Check the electrode area for burned-on food or grease. See the Care and Cleaning of the range section.
	Food residue on electrode	Lightly polish flat tip of electrode with nail file or sandpaper until shiny.

Troubleshooting Tips ... Before you call for service

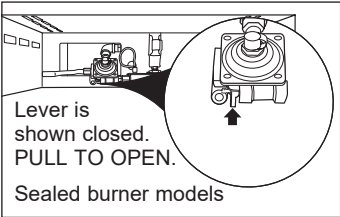
Problem	Possible Cause	What To Do
Top burners do not burn evenly	Improper burner assembly.	Make sure the burner caps are seated correctly. See the Care and Cleaning of the range section.
	Burner slots on the side of the burner may be clogged.	Remove the burners for cleaning. See the Care and Cleaning of the range section.
Burner flames are very large or yellow	Improper air to gas ratio.	If range is connected to Propane gas, contact the technician who installed your range or made the conversion.
Surface burners light but bake and broil burners do not.	Gas to the oven burners may have been shut off.	<p>The oven gas shut-off is located on the gas regulator near the gas line attachment to your range. Locate it and flip the lever.</p>  <p>Lever is shown closed. PULL TO OPEN. Sealed burner models</p>
My oven door glass appears to be "tinted" or have a "rainbow" color.	The inner oven glass is coated with a heat barrier to reflect the heat back into the oven to prevent heat loss and keep the outer door cool while baking.	This is normal. Under certain light or angles, you may see this tint or rainbow color.
Drawer does not slide smoothly or drags	The drawer is out of alignment.	Fully extend the drawer and push it all the way in. See the Care and Cleaning of the range section.
	Drawer is over-loaded or load is unbalanced.	Reduce weight or redistribute drawer contents.

Notes

Notes

GE Appliances Gas Range Limited Warranty

GEAppliances.ca/en/

All warranty service is provided by our Factory Service Centers, or an authorized Customer Care® technician. To schedule service online, visit us at www.geappliances.ca/en/support/service-request or call GE Appliances at 800.561.3344. Please have your serial number and your model number available when calling for service.

Servicing your appliance may require the use of the onboard data port for diagnostics. This gives a GE Appliances factory service technician the ability to quickly diagnose any issues with your appliance and helps GE Appliances improve its products by providing GE Appliances with information on your appliance. If you do not want your appliance data to be sent to GE Appliances, please advise your technician not to submit the data to GE Appliances at the time of service.

For the period of	MC Commercial Inc. will replace
One year From the date of the original purchase	Any part of the range which fails due to a defect in materials or workmanship. During this limited one-year warranty , GE Appliances will provide, free of charge , all labor and in-home service to replace the defective part.

What MC Commercial Inc. will not cover:

- Service trips to your home to teach you how to use the product.
- Improper installation, delivery, or maintenance.
- Failure of the product if it is abused, misused, modified, or used for other than the intended purpose or used commercially.
- Replacement of house fuses or resetting of circuit breakers.
- Damage to the product caused by accident, fire, floods, or acts of God.
- Damage to finish, such as surface rust, tarnish, or small blemishes not reported within 48 hours of delivery.
- Incidental or consequential damage caused by possible defects with this appliance.
- Damage caused after delivery.
- Product not accessible to provide required service.
- Service to repair or replace light bulbs, except for LED lamps.

EXCLUSION OF IMPLIED WARRANTIES

Your sole and exclusive remedy is product repair as provided in this Limited Warranty. Any implied warranties, including the implied warranties of merchantability or fitness for a particular purpose, are limited to one year or the shortest period allowed by law.

This limited warranty is extended to the original purchaser and any succeeding owner for products purchased for home use within the USA. If the product is located in an area where service by a GE Appliances Authorized Servicer is not available, you may be responsible for a trip charge or you may be required to bring the product to an Authorized GE Appliances Service location for service. In Alaska, the limited warranty excludes the cost of shipping or service calls to your home.

Some states do not allow the exclusion or limitation of incidental or consequential damages. This limited warranty gives you specific legal rights, and you may also have other rights which vary from state to state. To know what your legal rights are, consult your local or state consumer affairs office or your state's Attorney General.

Warrantor: MC Commercial Inc.
Burlington, ON, LR7 5B6

Extended Warranties: Purchase a GE Appliances extended warranty and learn about special discounts that are available while your warranty is still in effect. You can purchase it online anytime at

www.geappliances.ca/en/support/purchase-extended-warranty

or call 1-866-277-9842 during normal business hours. GE Appliances Service will still be there after your warranty expires.

Staple your receipt here. Proof of the original purchase date is needed to obtain service under the warranty.

Accessories

Looking For Something More?

GE Appliances offers a variety of accessories to improve your cooking and maintenance experiences!

Refer to the Consumer Support page for phone numbers and website information.

The following products and more are available:

Accessories

Nickel Flat Rack

Reinforced Nickel Flat Rack

Self Clean Flat Rack

Nickel Extension Rack

Self Clean Extension Rack

Broiler Pan (12 ¾" x 1 ¼" x 16 ½")

Roasting Rack Accessory

Cooktop Center Grate

Nonstick Aluminum Griddle

Reversible Cast-Iron Griddle

Cleaning Supplies

CitruShine™ Stainless Steel Wipes

Stainless Steel Polishing Cloth

Burnt-On Grease Remover

Consumer Support

GE Appliances Website

Have a question or need assistance with your appliance? Try the GE Appliances Website 24 hours a day, any day of the year! You can also shop for more great GE Appliances products and take advantage of all our on-line support services designed for your convenience. [GEAppliances.ca/en/](https://www.geappliances.ca/en/)

Register Your Appliance

Register your new appliance on-line at your convenience! Timely product registration will allow for enhanced communication and prompt service under the terms of your warranty, should the need arise. You may also mail in the pre-printed registration card included in the packing material.

<https://www.geappliances.ca/en/support/register-your-appliance>

Schedule Service

Expert GE Appliances repair service is only one step away from your door. Get on-line and schedule your service at your convenience any day of the year. <https://www.geappliances.ca/en/support/service-request> or call 800.561.3344 during normal business hours.

Extended Warranties

Purchase a GE Appliances extended warranty and learn about special discounts that are available while your warranty is still in effect. You can purchase it on-line anytime. GE Appliances Services will still be there after your warranty expires. www.geappliances.ca/en/support/purchase-extended-warranty or call 866.277.9842 during normal business hours.

Remote Connectivity

For assistance with wireless network connectivity (for models with remote enable), visit our website at <https://www.geappliances.ca/en/contact-us> or call 800.220.6899

Parts and Accessories

Individuals qualified to service their own appliances can have parts or accessories sent directly to their homes (VISA, MasterCard and Discover cards are accepted). Order on-line today 24 hours every day.

<https://www.geappliances.ca/en/products/parts-filters-accessories> or by phone at 1-800-661-1616 during normal business hours.

Instructions contained in this manual cover procedures to be performed by any user. Other servicing generally should be referred to qualified service personnel. Caution must be exercised, since improper servicing may cause unsafe operation.

Contact Us

If you are not satisfied with the service you receive from GE Appliances, contact us on our Website with all the details including your phone number, or write to:

General Manager, Customer Relations | MC Commercial Inc. Burlington ON, L7R 5B6
<https://www.geappliances.ca/en/contact-us>