



Electric Radiant Slide-In RANGES

SAFETY INFORMATION 3

USING THE RANGE

Surface Units..... 8

Cookware for Radiant Copoktop10

Oven Controls.....11

Special Features12

Sabbath Mode.....13

Oven Racks14

Aluminum Foil and Oven Liners.....15

Cookware.....15

Cooking Modes.....16

Cooking Guide17

CARE AND CLEANING

Cleaning the Range - Exterior..... 18

Cleaning the Range - Interior 19

Cleaning the Glass Cooktop..... 20

Oven Light..... 22

Oven Door..... 22

TROUBLESHOOTING TIPS..... 23

WARRANTY..... 26

ACCESSORIES 27

CONSUMER SUPPORT 28

OWNER'S MANUAL

JCS630
JCS830
JCS840

Write the model and serial numbers here:

Model # _____

Serial # _____

You can find the rating label on the front behind the range drawer.

FRANÇAIS
For a French version of this use and care manual, visit our website GEAppliance.ca

THANK YOU FOR MAKING GE APPLIANCES A PART OF YOUR HOME.

Whether you grew up with GE Appliances, or this is your first, we're happy to have you in the family.

We take pride in the craftsmanship, innovation and design that goes into every GE Appliances product, and we think you will too. Among other things, registration of your appliance ensures that we can deliver important product information and warranty details when you need them.

Register your GE appliance now online. Helpful websites and phone numbers are available in the Consumer Support section of this Owner's Manual. You may also mail in the pre-printed registration card included in the packing material.



IMPORTANT SAFETY INFORMATION

READ ALL INSTRUCTIONS BEFORE USING THE APPLIANCE

▲WARNING Read all safety instructions before using the product. Failure to follow these instructions may result in fire, electrical shock, serious injury or death.

ANTI-TIP DEVICE

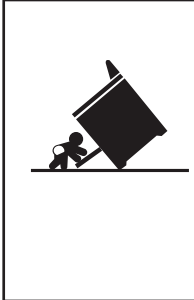

▲WARNING

Tip-Over Hazard

- A child or adult can tip the range and be killed.
- Install the anti-tip bracket to the wall or floor.
- Engage the range to the anti-tip bracket by sliding the range back such that the foot is engaged.
- Re-engage the anti-tip bracket if the range is moved.
- Failure to do so can result in death or serious burns to children or adults.

To reduce the risk of tipping the range, the range must be secured by a properly installed anti-tip bracket. See installation instructions shipped with the bracket for complete details before attempting to install.

For Free-Standing and Slide-In Ranges

To check if the bracket is installed and engaged properly, look underneath the range to see that the rear leveling leg is

engaged in the bracket. On some models, the storage drawer or kick panel can be removed for easy inspection. If visual inspection is not possible, slide the range forward, confirm the anti-tip bracket is securely attached to the floor or wall, and slide the range back so the rear leveling leg is under the anti-tip bracket.

If the range is pulled from the wall for any reason, always repeat this procedure to verify the range is properly secured by the anti-tip bracket.

Never completely remove the leveling legs or the range will not be secured to the anti-tip device properly.

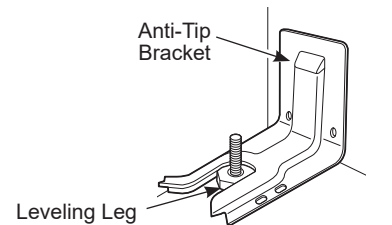

Free-Standing and Slide-In Ranges

▲WARNING GENERAL SAFETY INSTRUCTIONS

This unit has been tested and found to comply with the limits for a class B digital device, pursuant to Part 18 of the FCC rules. These limits are designed to provide reasonable protection against harmful interference in a residential installation. This unit generates, uses and can radiate radio frequency energy and, if not installed and used in accordance with the instructions, may cause harmful interference to radio communications. However, there is no guarantee that interference will not occur in a particular installation. If this unit does cause harmful interference to radio or television reception, which can be determined by turning the unit off and on, the user is encouraged to try to correct the interference by one or more of the following measures:

- Reorient or relocate the receiving antennae.
- Increase the distance between the unit and receiver.
- Connect the unit into an outlet or a circuit different from that to which the receiver is connected.

▲CAUTION

Persons with a pacemaker or similar medical device should exercise caution when using or standing near an induction unit while it is in operation. The electromagnetic field may affect the working of the pacemaker or similar medical device. It is advisable to consult your doctor or the pacemaker manufacturer about your particular situation.

- Use this appliance only for its intended purpose as described in this Owner's Manual.
- Be sure your appliance is properly installed and grounded by a qualified installer in accordance with the provided installation instructions.
- Do not attempt to repair or replace any part of your range unless it is specifically recommended in this manual. All other servicing should be transferred to a qualified technician.

READ AND SAVE THESE INSTRUCTIONS

IMPORTANT SAFETY INFORMATION

READ ALL INSTRUCTIONS BEFORE USING THE APPLIANCE

⚠ WARNING GENERAL SAFETY INSTRUCTIONS (Cont.)

- Before performing any service, unplug the range or disconnect the power supply at the household distribution panel by removing the fuse or switching off the circuit breaker.
- Do not leave children alone—children should not be left alone or unattended in an area where an appliance is in use. They should never be allowed to climb, sit or stand on any part of the appliance.
- **⚠ CAUTION** Do not store items of interest to children above a range or on the backguard of a range—children climbing on the range to reach items could be seriously injured.
- Use only dry pot holders—moist or damp pot holders on hot surfaces may result in burns from steam. Do not let pot holders touch hot surface units or heating elements. Do not use a towel or other bulky cloth in place of pot holders.
- Never use your appliance for warming or heating the room.
- Do not touch the surface units, the heating elements or the interior surface of the oven. These surfaces may be hot enough to burn even though they are dark in color. During and after use, do not touch, or let clothing or other flammable materials contact the surface units, areas nearby the surface units or any interior area of the oven; allow sufficient time for cooling first. Other surfaces of the appliance may become hot enough to cause burns. Potentially hot surfaces include the cooktop, areas facing the cooktop, oven vent opening, surfaces near the opening and crevices around the oven door.
- Do not heat unopened food containers. Pressure could build up and the container could burst, causing an injury.
- Do not use any type of foil or liner to cover the oven bottom or anywhere in the oven, except as described in this manual. Oven liners can trap heat or melt, resulting in damage to the product and risk of shock, smoke or fire.
- Avoid scratching or impacting glass doors, cook tops or control panels. Doing so may lead to glass breakage. Do not cook on a product with broken glass. Shock, fire or cuts may occur.
- Cook meat and poultry thoroughly—meat to at least an internal temperature of 160°F and poultry to at least an internal temperature of 180°F. Cooking to these temperatures usually protects against foodborne illness.

⚠ WARNING KEEP FLAMMABLE MATERIALS AWAY FROM THE RANGE

Failure to do so may result in fire or personal injury.

- Do not store or use flammable materials in an oven or near the cooktop, including paper, plastic, pot holders, linens, wall coverings, curtains, drapes and gasoline or other flammable vapors and liquids.
- Never wear loose-fitting or hanging garments while using the appliance. These garments may ignite if they contact hot surfaces causing severe burns.
- Do not let cooking grease or other flammable materials accumulate in or near the range. Grease in the oven or on the cooktop may ignite.
- Clean ventilating hoods frequently. Grease should not be allowed to accumulate on the hood or filter.

⚠ WARNING IN THE EVENT OF A FIRE, TAKE THE FOLLOWING STEPS TO PREVENT INJURY AND FIRE SPREADING

- Do not use water on grease fires. Never pick up a flaming pan. Turn the controls off. Smother a flaming pan on a surface unit by covering the pan completely with a well-fitting lid, cookie sheet or flat tray. Use a multi-purpose dry chemical or foam-type fire extinguisher.
- If there is a fire in the oven during baking, smother the fire by closing the oven door and turning the oven off or by using a multi-purpose dry chemical or foam-type fire extinguisher.
- If there is a fire in the oven during self-clean, turn the oven off and wait for the fire to go out. Do not force the door open. Introduction of fresh air at self-clean temperatures may lead to a burst of flame from the oven. Failure to follow this instruction may result in severe burns.

READ AND SAVE THESE INSTRUCTIONS

IMPORTANT SAFETY INFORMATION

READ ALL INSTRUCTIONS BEFORE USING THE APPLIANCE

▲WARNING COOKTOP SAFETY INSTRUCTIONS

- Never leave the surface units unattended at medium or high heat settings. Boilovers cause smoking and greasy spillovers that may catch on fire.
- Never leave oil unattended while frying. If allowed to heat beyond its smoking point, oil may ignite resulting in fire that may spread to surrounding cabinets. Use a deep fat thermometer whenever possible to monitor oil temperature.
- To avoid oil spillover and fire, use a minimum amount of oil when shallow pan-frying and avoid cooking frozen foods with excessive amounts of ice.
- Only certain types of glass, glass/ceramic, earthenware or other glazed containers are suitable for cooktop service; others may break because of the sudden change in temperature.
- To minimize the possibility of burns, ignition of flammable materials and spillage, the handle of a container should be turned toward the center of the range without extending over nearby surface units.
- When preparing flaming foods under a hood, turn the fan on.

▲WARNING GLASS COOKTOP SAFETY INSTRUCTIONS

- Use care when touching the cooktop. The glass surface of the cooktop will retain heat after the controls have been turned off.
- Do not cook on a broken cooktop. If glass cooktop should break, cleaning solutions and spillovers may penetrate the broken cooktop and create a risk of electric shock. Contact a qualified technician immediately.
- Avoid scratching the glass cooktop. The cooktop can be scratched with items such as knives, sharp instruments, rings or other jewelry, and rivets on clothing.
- Use CERAMA BRYTE® ceramic Cooktop Cleaner and CERAMA BRYTE® Cleaning Pad to clean the cooktop. Wait until the cooktop cools and the indicator light goes out before cleaning. A wet sponge or cloth on a hot surface can cause steam burns. Some cleaners can produce noxious fumes if applied to a hot surface. **NOTE:** Sugar spills are an exception. They should be scraped off while still hot using an oven mitt and a scraper. See the Cleaning the glass cooktop section for detailed instructions.
- Read and follow all instructions and warnings on the cleaning cream label.
- Do not place or store items that can melt or catch fire on the glass cooktop, even when it is not being used. If the cooktop is inadvertently turned on, they may ignite. Heat from the cooktop or oven vent after it is turned off may cause them to ignite also.
- Do not place metallic objects such as knives, forks, spoons and lids on the cooktop surface since they can get hot.

▲WARNING OVEN SAFETY INSTRUCTIONS

- Stand away from the range when opening the oven door. Hot air or steam which escapes can cause burns to hands, face and/or eyes.
- Do not use the oven if a heating element develops a glowing spot during use or shows other signs of damage. A glowing spot indicates the heating element may fail and present a potential burn, fire, or shock hazard. Turn the oven off immediately and have the heating element replaced by a qualified service technician.
- Keep the oven vent unobstructed.
- Keep the oven free from grease buildup. Grease in the oven may ignite.
- Place oven racks in desired location while oven is cool. If rack must be moved while oven is hot, do not let pot holder contact hot heating element in oven.
- When using cooking or roasting bags in the oven, follow the manufacturer's directions.

READ AND SAVE THESE INSTRUCTIONS

IMPORTANT SAFETY INFORMATION

READ ALL INSTRUCTIONS BEFORE USING THE APPLIANCE

▲WARNING OVEN SAFETY INSTRUCTIONS (Cont.)

- Pull the oven rack to the stop-lock position when loading and unloading food from the oven. This helps prevent burns from touching hot surfaces of the door and oven walls.
- Do not leave items such as paper, cooking utensils or food in the oven when not in use. Items stored in an oven can ignite.
- Never place cooking utensils, pizza or baking stones, or any type of foil or liner on the oven floor. These items can trap heat or melt, resulting in damage to the product and risk of shock, smoke or fire.

▲WARNING SELF-CLEANING OVEN SAFETY INSTRUCTIONS

The self-cleaning feature operates the oven at temperatures high enough to burn away food soils in the oven. Follow these instructions for safe operation.

- Do not touch oven surfaces during self-clean operation. Keep children away from the oven during self-cleaning. Failure to follow these instructions may cause burns.
- Before operating the self-clean cycle, remove pans, shiny metal oven racks and other utensils from the oven. Only gray porcelain-coated oven racks may be left in the oven. Do not use self-clean to clean other parts, such as drip pans or bowls.
- Before operating the self-clean cycle, wipe grease and food soils from the oven. Excessive amount of grease may ignite leading to smoke damage to your home.
- If the self-cleaning mode malfunctions, turn the oven off and disconnect the power supply. Have it serviced by a qualified technician.
- Do not clean the door gasket. The door gasket is essential for a good seal. Care should be taken not to rub, damage or move the gasket.
- Do not use oven cleaners. No commercial oven cleaner or oven liner protective coating of any kind should be used in or around any part of the oven.

▲WARNING WARMING DRAWER SAFETY INSTRUCTIONS (Some models)

- The purpose of the warming drawer is to hold hot cooked foods at serving temperature. Bacteria will grow in food while it is below 140°F. Do not put cold food in warming drawer. Do not heat food for more than 2 hours. Failure to follow these instructions may result in foodborne illness.
- Do not leave paper products, plastics, canned food or combustible materials in the drawer. They may ignite.
- Do not touch the heating element or the interior surface of the drawer. These surfaces may be hot enough to cause burns.
- Use care when opening the drawer. Open the drawer a crack and let hot air or steam escape before removing or replacing food. Hot air or steam that escapes can cause burns to hands, face and/or eyes.
- Do not use aluminum foil to line the lower drawer. The foil will trap heat below, and upset the performance of the oven. Foil can melt and permanently damage the drawer bottom. Damage from improper use of aluminum foil is not covered by the product warranty.

READ AND SAVE THESE INSTRUCTIONS

IMPORTANT SAFETY INFORMATION

READ ALL INSTRUCTIONS BEFORE USING THE APPLIANCE

How to Remove Protective Shipping Film and Packaging Tape

Carefully grasp a corner of the protective shipping film with your fingers and slowly peel it from the appliance surface. Do not use any sharp items to remove the film. Remove all of the film before using the appliance for the first time.

To assure no damage is done to the finish of the product, the safest way to remove the adhesive from packaging tape on new appliances is an application of a household liquid dishwashing detergent. Apply with a soft cloth and allow to soak.

NOTE: The adhesive must be removed from all parts. It cannot be removed if it is baked on.

READ AND SAVE THESE INSTRUCTIONS

Surface Units - Knob Models

▲ WARNING **FIRE HAZARD:** Never leave the range unattended with the cooktop on medium or high settings. Keep flammable items away from the cooktop. Turn off all controls when done cooking. Failure to follow these instructions can result in fire, serious injury or death.

Throughout this manual, features and appearance may vary from your model.

How to Set

Push the knob in and turn in either direction to the setting you want.

A surface ON indicator light will glow when any surface unit is on.

For glass cooktop surfaces:

A **HOT COOKTOP** indicator light will:

- come on when the unit is hot to the touch.
- stay on even after the unit is turned off.
- stay on until the unit is cooled to approximately 150°F.

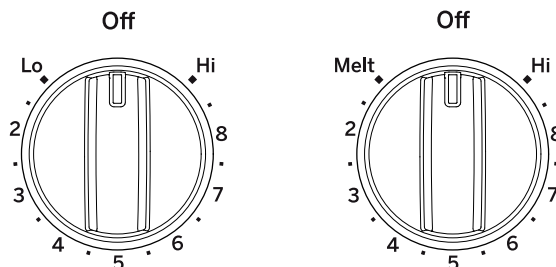

At both OFF and HI the control clicks into position. You may hear slight clicking sounds during cooking, indicating the control is maintaining your desired setting. Be sure you turn the control knob to OFF when you finish cooking.

Melt setting (on some models) will melt chocolate or butter.

Dual and Triple Surface Units and Control Knobs (on some models)

The surface unit has 2 or 3 cooking sizes to select from so you can match the size of the unit to the size of the cookware you are using.

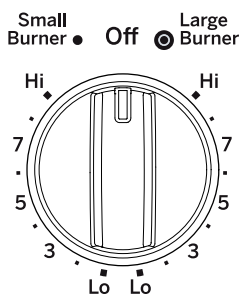

Models with a Dual-Ring surface element only.

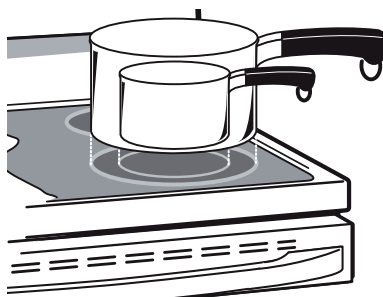

Using the Warming Zone (on some models)

▲ WARNING

FOOD POISON HAZARD: Bacteria may grow in food at temperatures below 140°F.

- Always start with hot food. Do not use warm setting to heat cold food.
- Do not use warm setting for more than 2 hours.

The **WARMING ZONE**, located in the back center of the glass surface, will keep hot, cooked food at serving temperature. Always start with hot food. Do not use to heat cold food. Placing uncooked or cold food on the **WARMING ZONE** could result in foodborne illness.

Turn the control knob to the ON position.

For models using the touch pads for warming zone control, see section on "Using the Oven" for additional details.

For best results, all foods on the **WARMING ZONE** should be covered with a lid or aluminum foil. When warming pastries or breads, the cover should be vented to allow moisture to escape.

The initial temperature, type and amount of food, type of pan, and the time held will affect the quality of the food. Always use pot holders or oven mitts when removing food from the **WARMING ZONE**, since cookware and plates will be hot.

NOTE: The surface warmer will not glow red like the cooking elements.

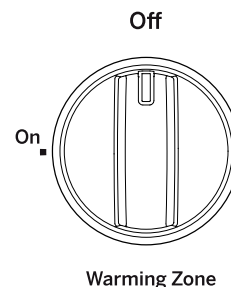

Surface Units (Cont.)

Home Canning Tips

Be sure the canner is centered over the surface unit.

Make sure the canner is flat on the bottom.

To prevent burns from steam or heat, use caution when canning.

Use recipes and procedures from reputable sources. These are available from manufacturers such as Ball® and Kerr® and the Department of Agriculture Extension Service.

Flat-bottomed canners are recommended. Use of water bath canners with rippled bottoms may extend the time required to bring the water to a boil.

Radiant Glass Cooktop

The radiant cooktop features heating units beneath a smooth glass surface.

NOTE: A slight odor is normal when a new cooktop is used for the first time. It is caused by the heating of new parts and insulating materials and will disappear in a short time.

NOTE: On models with light-colored glass cooktops, it is normal for the cooking zones to change color when hot or cooling down. This is temporary and will disappear as the glass cools to room temperature.

The surface unit will cycle on and off to maintain your selected control setting.

It is safe to place hot cookware on the glass surface even when the cooktop is cool.

Even after the surface units are turned off, the glass cooktop retains enough heat to continue cooking. To avoid overcooking, remove pans from the surface units when the food is cooked. Avoid placing anything on the surface unit until it has cooled completely.

- Water stains (mineral deposits) are removable using the cleaning cream or full-strength white vinegar.
- Use of window cleaner may leave an iridescent film on the cooktop. The cleaning cream will remove this film.
- Don't store heavy items above the cooktop. If they drop onto the cooktop, they can cause damage.
- Do not use the surface as a cutting board.



Never cook directly on the glass. Always use cookware.



Always place the pan in the center of the surface unit you are cooking on.



Do not slide cookware across the cooktop because it can scratch the glass—the glass is scratch-resistant, not scratch proof.

Temperature Limiter on Radiant Glass Cooktops

Every radiant surface unit has a temperature limiter.

The temperature limiter protects the glass cooktop from getting too hot.

The temperature limiter may cycle the surface units off for a time if:

- the pan boils dry.
- the pan bottom is not flat.
- the pan is off-center.
- there is no pan on the unit.

Selecting types of cookware for glass cooktop models

The following information will help you choose cookware which will give good performance on glass cooktops. See insert for cookware to use with induction cooktops.

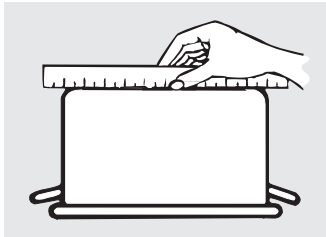

Check pans for flat bottoms by using a straight edge..



Pans with rounded, curved, ridged or warped bottoms are not recommended.

Stainless Steel:

Recommended

Aluminum:

Heavy weight recommended. Good conductivity. Aluminum residues sometimes appear as scratches if cleaned cooktop but can be removed if cleaned immediately. Because of its low melting point, thin weight aluminum should not be used.

Copper Bottom:

Recommended

Copper may leave residues which can appear as scratches. The residues can be removed, as long as the cooktop is cleaned immediately. However, do not let these pots boil dry. Overheated metal can bond to glass cooktops. An overheated copper bottom pot will leave a residue that will permanently stain the cooktop if not removed immediately.

NOTE: Follow all cookware manufacturer's recommendations when using any type of cookware on the ceramic cooktops.

Porcelain Enamel on Cast Iron:

Recommended if bottom pan is coated.

Porcelain Enamel on Steel:

Not recommended.

Heating empty pans can cause permanent damage to cooktop glass. The enamel can melt and bond to the ceramic cooktop.

Glass-ceramic:

Not recommended.

Poor performance. Will scratch the surface.

Stoneware:

Not recommended.

Poor performance. May scratch the surface.

Cast Iron:

Not recommended - unless designed specifically for glass cooktops. Poor conductivity and slow to absorb heat. Will scratch the cooktop surface.

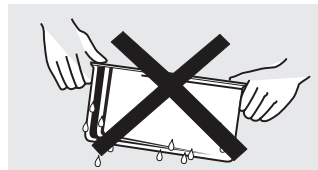

Do not place wet pans on the glass cooktop.



Do not use woks with support rings on the glass cooktop.



Use flat-bottomed woks on the glass cooktop.

For Best Results

- Place only dry pans on the surface elements. Do not place lids on the surface elements, particularly wet lids.
- Do not use woks that have support rings, This type of wok will not heat on glass surface elements.
- We recommend that you use only a flat-bottomed wok. They are available at your local retail store. The bottom of the wok should have the same diameter as the surface element to ensure proper contact.
- Some special cooking procedures require specific cookware such as pressure cookers, deep-fat fryers, etc. All cookware must have flat bottoms and be the correct size.

Oven Controls

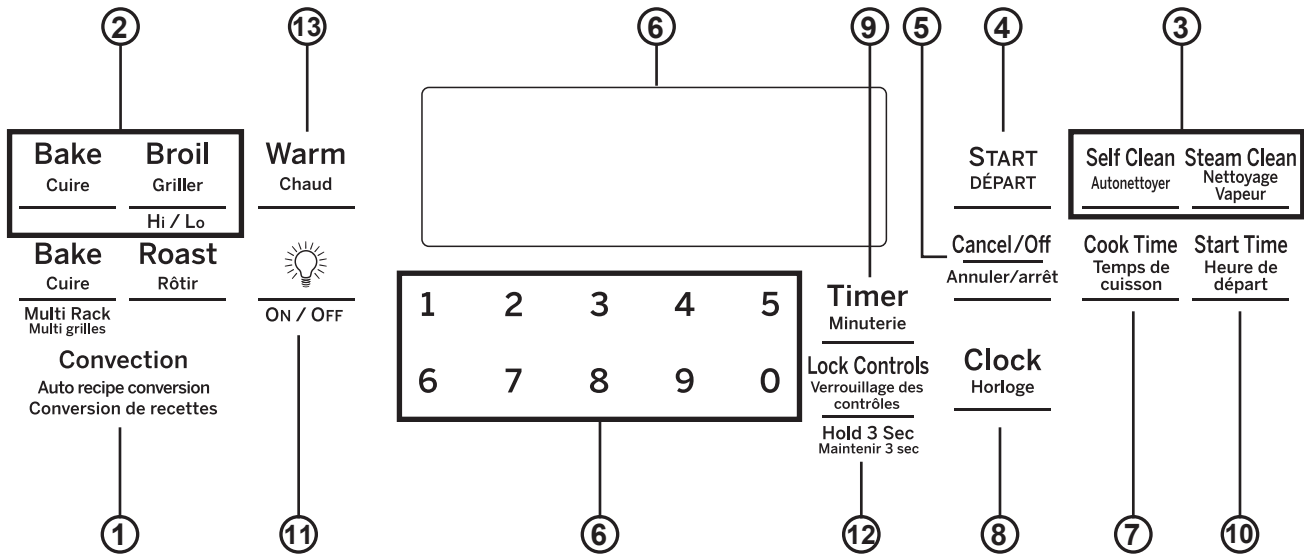

- Convection Cooking (on some models):** Convection cooking modes use increased air circulation to improve performance. See the Cooking Modes section for more information.
- Traditional Cooking Modes:** Your oven has the following traditional cooking modes: Bake and Broil Hi/Lo. See the Cooking Modes section for more information.
- Clean:** Your oven has two cleaning modes: Self Clean and Steam Clean. See the Cleaning the Oven section for important information about using these modes.
- Start:** Must be pressed to start any cooking, cleaning, or timed function.
- Cancel/Off:** Cancels ALL oven operations except the clock and timer.
- Number Pad**
- Cook Time:** Counts down cooking time and turns off the oven when the cooking time is complete. Press the **Cook Time** pad, use the **number** pads to program a cooking time in hours and minutes, then press **Start**. This can only be used with Bake, Convection Bake, and Convection Roast (where available).
- Clock:** Sets the oven clock time. Press the **Set Clock** pad twice and the **number** pads to program the clock. Press **Start** to save the time.
- Timer:** Works as a countdown timer. Press the **Timer** pad and the **number** pads to program the time in hours and minutes. Press the **Start** pad. The timer countdown is complete. To turn the timer off press the **Timer** pad.
- Start Time:** Start when the oven will turn on. Use this to set a time when you want the oven to start. Press the **Start Time** pad and use the **number** pads to program the time of day for the oven to turn on then press **Start**. Press the desired cooking mode and temperature then press **Start**. A Cook Time may also be programmed if desired. Follow the directions under Cook Time for setting this feature. This can only be used with Bake, Convection Bake and Self-Clean.
NOTE: When using the Delay Time feature, foods that spoil easily—such as milk, eggs, fish, stuffings, poultry and pork—should not be allowed to sit for more than 1 hour before or after cooking. Room temperature promotes the growth of harmful bacteria. Be sure that the oven light is off because heat from the bulb will speed harmful bacteria growth.
- Oven Light:** Turns the oven light on or off.
- Lock Controls:** Locks out the control so that pressing the pads does not activate the controls. Press and hold the **number** pads or the **Lock Controls** pad, for three seconds to lock or unlock the control. **Cancel/Off** is always active, even when the control is locked.
- Warm:** Warm mode is designed to keep hot foods hot for up to 3 hours. To use this mode, select **WARM** and then **START**. Cover foods that need to remain moist and do not cover foods that should be crisp. Preheating is not required. Do not use warm to heat cold food other than crisping crackers, chips or dry cereal. It is also recommended that food not be kept warm for more than 2 hours.

Special Features

There are several different special features on your range.

- To enter the Special Features menu, press the **Bake** and **Broil** pads at the same time and hold for three seconds. "OFFSEt" will appear in the display.
- Scroll through Special Features menu using the **8** pad for down and the **3** pad for up.
- To select a feature to change, or to confirm a change, press the **0** pad.
- To cancel a change and return to the Special Features menu, press the **6** pad. To exit the Special Features menu, press the **6** pad again.

Adjust the Oven Temperature (OFFSEt)

This feature allows the oven baking and convection baking temperature to be adjusted up to 35°F hotter or down to 35°F cooler. Use this feature if you believe your oven temperature is too hot or too cold and wish to change it. This adjustment affects Bake and Convection Bake modes. No other cooking modes are affected.

Using the number pads to navigate as described above, select "OFFSEt". A number between positive and negative 35 will display. Use the **8** or **3** pads to increase or decrease the offset value. Save and confirm by pressing the **0** pad.

Sound Volume (Sound)

This feature allows the oven tone volume to be adjusted between high (Hi), medium (rEg), low (Lo), and off (OFF). The control will sound the oven tone at the new volume level each time the sound level is changed.

End of Timer Signals (End tonE)

This is the tone that signals the end of a timer. The tone can be continuous (Cont) or one repeating beep (bEEP). A continuous setting will continue to sound a tone until a button on the control is pressed.

12-hour Shutoff (2H ShutoFF)

This feature shuts the oven down after 12 hours of continuous operation. It may be enabled or disabled.

Fahrenheit or Celsius Temperature Display (dEg Unit)

The oven control is set to use Fahrenheit temperatures (F), but you can change it to use Celsius temperatures (C).

Clock Display (Cloc diSP)

This feature specifies whether the clock appears in the display. It may be On or Off.

Clock Configuration (Cloc cFg)

This feature specifies how the time of day will be displayed. You can select a standard 12-hour clock (12) or 24-hour military time (24).

Auto Recipe Conversion (Auto rEciPE)

When using Convection Bake cooking, Auto Recipe Conversion will automatically convert the regular baking temperatures entered to convection bake cooking temperatures when turned on. Note that this option does not convert convection bake cooking times, it only converts temperatures. This feature may be turned On or Off.

Sabbath Mode

The Sabbath mode feature complies with standards set forth by Star K. Some of these standards that will be noticed by the consumer include the disabling of tones, disabling of oven lights, and delays of about 30 seconds to one minute on display changes. Only continuous baking or timed baking is allowed in the Sabbath mode. Cooking in the Sabbath mode is a two-step process, first the Sabbath mode must be set and then the bake mode must be set.

Setting the Sabbath Mode

1. Press the **Bake** and **Broil** pads at the same time and hold until the special features menu is displayed.
2. Use the **3** or **8** number pads to scroll through the special features until "SAbbAth" is displayed and then press **0**. Refer to the graphic in the Special Features section to see how the number keys are mapped.
3. Use the **3** or **8** number pads to scroll through the options until "On" is shown in the display, then press the **0** number pad to save the setting. Press **6** to exit the Special Features menu. A single bracket "]" will appear in the display indicating that the Sabbath mode is set. The clock will not be displayed. Continuous bake or timed bake can now be programmed.

Starting a Continuous Bake

1. Press the **Bake** pad.
2. If the desired temperature is 350F, press **Start**. If a different cooking temperature is desired, use the **1** through **5** number pads or **Timer** pad to select a preset cooking temperature, then press **Start**. Refer to the graphic below to determine which pad sets the desired cooking temperature.

After a delay, a second bracket "]" will appear in the display indicating that the oven is baking.

Temperature (°F)					400
1	2	3	4	5	Timer
170	200	250	300	325	On/Off
6	7	8	9	0	Lock
2h	2.5h	3h	3.5h	4h	Controls
Time (hours)					6h

1 = 170° F, 2 = 200° F, 3 = 250° F, 4 = 300° F, 5 = 325° F, Timer = 400° F

6 = 2 hours, 7 = 2.5 hours, 8 = 3 hours, 9 = 3.5 hours,
0 = 4 hours, Lock Controls = 6 hours

Adjusting the Temperature

1. Press **Bake**, use the **1** through **5** number pads and the **Timer** pad to select a different preset cooking temperature, and press **Start**.
2. Since no feedback is given during temperature change, an oven thermometer can be used to confirm temperature changes.

Starting a Timed Bake

1. Press the **Bake** pad.
2. If the desired temperature is 350F, use the **6** through **0** number pads or the **Lock Control** pad to select a cooking time. If a cooking temperature other than 350F is desired, use the **1** through **5** number pads or the **Timer** pad to select a preset cooking temperature, then select the cooking time. Refer to the graphic on this page to determine which pad sets the desired cooking temperature and cooking time.
3. Press **Start**.

After a delay, a second bracket "]" will appear in the display indicating that the oven is baking. When the cook time expires, the display will change back to a single bracket "]" indicating that the oven is no longer baking. No tone will sound when the cook time is complete.

Exit the Sabbath Mode

Exiting the Sabbath mode should be done after the Sabbath is over.

1. Press **Cancel/Off** to end any bake mode that may be running.
2. Press **Bake** and **Broil** pads at the same time and hold until the Special Features menu is displayed.
3. Use the **3** or **8** number pads to scroll through the special features until "SAbbAth" is displayed, then press **0**.
4. Use the **3** or **8** number pads to scroll through the options until "OFF" is displayed and press **0** to save the setting. Press the **6** number pad to exit the Special Features menu.

Sabbath Mode Power Outage Note

If a power outage occurs while the oven is in Sabbath Mode, the unit will return to Sabbath Mode when power is restored, however the oven will return to the off state even if it was in the middle of a bake cycle when the power outage occurred.

Oven Racks

Recommended rack positions for various types of foods are provided in the Cooking Guide. Adjusting rack position is one way to impact cooking results. For example, if you would prefer darker tops on cakes, muffins, or cookies, try moving food one rack position higher. If you find foods are too brown on top try moving them down next time.

When baking with multiple pans and on multiple racks, ensure there is at least 1½" between pans to allow sufficient space for air to flow.

Your Oven may have extension racks and/or traditional flat racks.

To avoid possible burns, place the racks in the desired position before you turn the oven on.

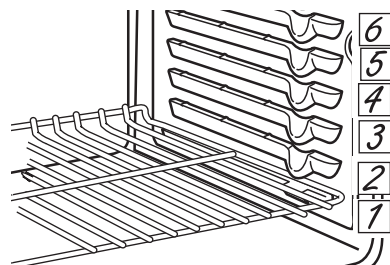

The number of rack positions may vary by model.

Aluminum Foil and Oven Liners

⚠ CAUTION Do not use any type of foil or oven liner to cover the oven bottom. These items can trap heat or melt, resulting in damage to the product and risk of shock, smoke or fire. Damage from improper use of these items is not covered by the product warranty.

Foil may be used to catch spills by placing a sheet on a lower rack, several inches below the food. Do not use more foil than necessary and never entirely cover an oven rack with aluminum foil. Keep foil at least 1-1/2" from oven walls to prevent poor heat circulation.

Cookware

Cookware Guidelines

The material, finish, and size of cookware affect baking performance.

Dark, coated and dull pans absorb heat more readily than light, shiny pans. Pans that absorb heat more readily can result in a browner, crisper, and thicker crust. If using dark and coated cookware check food earlier than minimum cook time. If undesirable results are obtained with this type of cookware consider reducing oven temperature by 25°F next time.

Shiny pans can produce more evenly cooked baked goods such as cakes and cookies.

Glass and ceramic pans heat slowly but retain heat well. These types of pans work well for dishes such as pies and custards.

Air insulated pans heat slowly and can reduce bottom browning.

Keep cookware clean to promote even heating.

Cooking Modes

Your new oven has a variety of cooking modes to help you get the best results. These modes are described below. Refer to the Cooking Guide section for recommendations for specific foods. Remember, your new oven may perform differently than the oven it is replacing. **NOTE:** Remove unused racks when using the oven for faster preheat, improved efficiency and optimal performance.

Baking and Roasting Modes

Select a mode for baking and roasting based on the type and quantity of food you are preparing. When preparing baked goods such as cakes, cookies, and pastries always preheat the oven first. Follow recipe recommendations for food placement. If no guidelines are provided, center food in the oven.

Traditional Bake

The traditional bake mode is intended for single rack cooking. This mode uses heat primarily from the lower element but also from the upper element to cook food. To use this mode press the **Bake** pad, enter a temperature, and then press **Start**. Preheating is generally recommended when using this mode.

Convection Bake

The Convection Bake mode is intended for baking on multiple racks at the same time. This mode uses heat from the upper and lower elements, along with air movement from the convection fan to enhance cooking evenness. Your oven is equipped with Auto Recipe Conversion, so it is not necessary to convert the temperature when using this mode. Baking time might be slightly longer for multiple racks than what would be expected for a single rack. To use this mode press the **Convection Bake** pad, enter a temperature, and then press **Start**. Always preheat when using this mode.

Convection Roast

The Convection Roast mode is intended for roasting whole cuts of meat on a single rack. This mode uses heat from the lower, upper, and rear elements along with air movement from the convection fan to improve browning and reduce cooking time. It is not necessary to convert temperature. Check food earlier than the recipe suggested time when using this mode or use a meat probe. To use this mode press the **Convection Roast** pad, enter a temperature, and then press **Start**. It is not necessary to preheat when using this mode.

Broiling Modes

Always broil with the door closed. Monitor food closely while broiling. Use caution when broiling on upper rack positions as placing food closer to the broil element increases smoking, spattering, and the possibility of fats igniting. For best performance center food below the broil heating element. **Broiling on rack position 7 is not recommended.**

Try broiling foods that you would normally grill. Adjust rack positions to adjust the intensity of the heat to the food. Place foods closer to the broil element when a seared surface and rare interior is desired. Thicker foods and foods that need to be cooked through should be broiled on a rack position farther from the broiler or by using **Broil Lo**.

Broil Hi

The Broil Hi mode uses intense heat from the upper element to sear foods. Use Broil Hi for thinner cuts of meat and/ or foods you prefer less done on the interior. To use this mode press the **Broil** pad once and then press **Start**. It is not necessary to preheat when using this mode.

Broil Lo

The Broil Lo mode uses less intense heat from the upper element to cook food thoroughly while also producing surface browning. Use Broil Lo for thicker cuts of meat and/or foods that you would like cooked all the way through. To use this mode press the **Broil** pad **twice** and then press **Start**. It is not necessary to preheat when using this mode.

Warm

To use this mode, press the **Warm** pad then press **Start**. Cover foods that need to remain moist and do not cover foods that should be crisp. Preheating is not required. Do not use warm to heat cold food other than crisping crackers, chips or dry cereal. It is also recommended that food not be kept warm for more than 2 hours.

Cooking Guide

FOOD TYPE	RECOMMENDED MODE(S)	RECOMMENDED RACK POSITION(S)	ADDITIONAL SUGGESTIONS
Baked Goods			
Layer Cakes, sheet cakes, bundt cakes, muffins, quick breads on a Single Rack	Bake	3	Use shiny cookware.
Layer cakes* on Multiple Racks	Bake Convection Bake	2 and 4	Use shiny cookware. Ensure adequate airflow (see illustration below).
Chiffon cakes (angel food)	Bake	1	Use shiny cookware.
Cookies, biscuits, scones on a Single Rack	Bake	3	Use shiny cookware.
Cookies, biscuits, scones on Multiple Racks	Convection Bake	2 and 4	Use shiny cookware. Ensure adequate airflow.
Beef & Pork			
Hamburgers	Broil Hi	6	Use a broil pan; move food down for more doneness/less searing. Watch food closely when broiling. For best performance center food below the broil heater.
Steaks & Chops	Broil Hi	5 or 6	Use a broil pan; move food down for more doneness/less searing. Watch food closely when broiling. For best performance center food below the broil heater.
Roasts	Bake Convection Roast	2 or 3	Use a low sided pan such as a broil pan. Preheating is not necessary.
Poultry			
Whole chicken	Bake Convection Roast	2 or 3	Use a low sided pan such as a broil pan. Preheating is not necessary.
Bone-in chicken breasts, legs, thighs	Broil Lo Bake	3	If breaded or coated in sauce avoid Broil Hi modes. Broil skin side down first. Watch food closely when broiling. For best performance when broiling, center food below the broil heater.
Boneless chicken breasts	Broil Lo Bake	3	If breaded or coated in sauce avoid Broil Hi modes. Broil skin side down first. Watch food closely when broiling. For best performance when broiling, center food below the broil heater.
Whole turkey	Bake Convection Roast	1	Use a low sided pan such as a broil pan. Preheating is not necessary.
Turkey Breast	Bake Convection Roast	3	Use a low sided pan such as a broil pan. Preheating is not necessary.
Fish	Broil Lo	6 (1/2 thick or less) 5 (>1/2 inch)	Watch food closely when broiling. For best performance center food below the broil heater.
Casseroles	Bake	3 or 4	
Frozen Convenience Foods			
Pizza, potato products, chicken nuggets, appetizers on a Single Rack	Bake	3	Use dark cookware for more browning/crisping; use shiny cookware for less browning.
Pizza, potato products, chicken nuggets, appetizers on Multiple Racks	Convection Bake	2 and 4	Use shiny cookware. Stagger pizzas left to right, do not place directly over each other.

*When baking four cake layers at a time, use racks 2 and 4. Place the pans as shown so that one pan is not directly above another.

Cook food thoroughly to help protect against food borne illness. Minimum safe food temperature recommendations for food safety can be found at www.IsItDoneYet.gov. Make sure to use a food thermometer to take food temperatures.

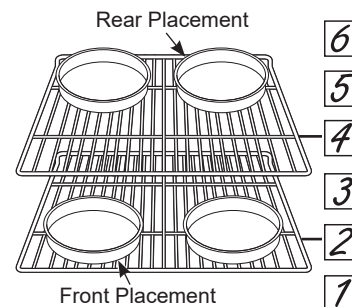

Rack positions

Cleaning the Range – Exterior

Be sure all controls are off and all surfaces are cool before cleaning any part of the range.



⚠ WARNING

If your range is removed for cleaning, servicing or any reason, be sure the anti-tip device is reengaged properly when the range is replaced. Failure to take this precaution could result in tipping of the range and can result in death or serious burns to children or adults.

Control Lockout

If desired, the touch pads may be deactivated before cleaning.

See Lock Controls in the Oven Controls section in this manual.

Clean up splatters with a damp cloth.

You may also use a glass cleaner.

Remove heavier soil with warm, soapy water. Do not use abrasives of any kind.

Reactivate the touch pads after cleaning.

Control Panel

It's a good idea to wipe the control panel after each use. Clean with mild soap and water or vinegar and water, rinse with clean water and polish dry with a soft cloth.

Do not use abrasive cleansers, strong liquid cleansers, plastic scouring pads or oven cleaners on the control panel—they will damage the finish, including Black Stainless Steel.

Oven Exterior

Do not use oven cleaners, abrasive cleansers, strong liquid cleansers, steel wool, plastic scouring pads, or cleaning powders on the interior or exterior of the oven. Clean with a mild soap and water or vinegar and water solution. Rinse with clean water and dry with a soft cloth. When cleaning surfaces, make sure that they are at room temperature and not in direct sunlight.

If stain on the door vent trim is persistent, use a mild abrasive cleaner and a sponge-scrubber for best results.

Spillage of marinades, fruit juices, tomato sauces and basting liquids containing acids may cause discoloration and should be wiped up immediately. Let hot surfaces

Painted Surfaces

Painted surfaces include the sides of the range and the door, top of control panel and the drawer front. Clean these with soap and water or a vinegar and water solution.

Do not use commercial oven cleaners, cleaning powders, steel wool or harsh abrasives on any painted surface, including Black Stainless Steel.

Stainless Steel excluding Black Stainless Steel (on some models)

Do not use a steel wool pad; it will scratch the surface.

To clean the stainless steel surface, use warm sudsy water or a stainless steel cleaner or polish. Always wipe the surface in the direction of the grain. Follow the cleaner instructions for cleaning the stainless steel surface.

To inquire about purchasing cleaning products including stainless steel appliance cleaner or polish, see the Accessories and Consumer Support sections at the end of this manual.

Cleaning the Range – Interior

The interior of your new oven can be cleaned manually or by using Steam Clean or Self Clean modes.

Spillage of marinades, fruit juices, tomato sauces and basting liquids containing acids may cause discoloration and should be wiped up immediately. Let hot surfaces cool, then clean and rinse.

Manual Cleaning

Do not use oven cleaners, abrasive cleaners, strong liquid cleansers, steel wool, scouring pads, or cleaning powders on the interior of the oven. Clean with a mild

soap and water or vinegar and water solution. Rinse with clean water and dry with a soft cloth. When cleaning surfaces, make sure that they are at room temperature.

Steam Clean Mode

Steam clean is intended to clean small spills using water and a lower cleaning temperature than Self-Clean.

To use the Steam Clean feature, wipe grease and soils from the oven. Pour one cup of water into the bottom of the oven. Close the door. Press the **Clean** pad twice to select **Steam** and then press **Start/Enter**. The oven

door will lock. You can not open the door during the 30 minute steam clean as this will decrease the steam clean performance. At the end of the steam clean cycle the door will unlock. Wipe out any excess water and any remaining soil.

Self Clean Mode

Read Self-Cleaning Oven Safety Instructions at the beginning of this manual before using Self Clean Mode. Self clean uses very high temperatures to clean the oven interior. The oven door will lock when using this feature. Before operating the self-clean cycle, wipe up grease and soils from the oven. Remove all items from the oven other than enameled (dark color) racks. Shiny or silver racks and any cookware or other items should all be removed from the oven before initiating a self-clean cycle. Close the door. Press the **Self Clean** pad and a default self-clean time is displayed. The clean time can be changed to any time between 3:00 and 5:00 hours by using the number pads to enter a different time and pressing **Enter**. For heavily soiled ovens, the maximum 5 hour clean time is recommended. If you wish to use the default time, press the **Start/Enter** pad. The oven will turn off automatically when the self-clean cycle is complete. The door will stay locked until the oven has cooled down. After the oven has cooled down wipe any ash out of the oven.

We recommend venting your kitchen with an open window or using a ventilation fan or hood during the first self-clean cycle.

Soil on the front frame of the range and outside the gasket on the door will need to be cleaned by hand. Clean these areas with hot water, soap-filled steel-wool pads or cleansers such as Soft Scrub®. Rinse well with clean water and dry.

Do not clean the gasket. The fiberglass material of the oven door gasket cannot withstand abrasion. It is essential for the gasket to remain intact. If you notice it becoming worn or frayed, replace it.

Make sure the oven light bulb cover is in place and the oven light is off.

IMPORTANT: The health of some birds is extremely sensitive to the fumes given off during the self-cleaning cycle of any range. Move birds to another well-ventilated room.

The surface units are automatically disabled during the self-clean cycle. Wait until the self-clean cycle is finished to set and use the surface units.

To stop a self clean cycle press the **Cancel/Off** pad. The door will unlatch once the oven has cooled below the locking temperature. You will not be able to open the door right away unless the oven has cooled below the locking temperature.

Racks

All racks can be washed with warm, soapy water. Enameled (not shiny) racks can be left in the cavity during self clean.

Racks may be more difficult to slide, especially after a self-clean. Put some vegetable oil on a soft cloth or paper towel and rub onto the left and right edges.

Oven Heating Elements

Do not clean the bake element or the broil element. Any soil will burn off when the elements are heated.

The bake element is not exposed and is under the oven floor. Clean the oven floor with warm, soapy water.

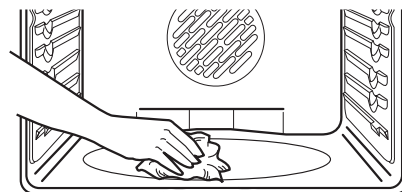

Wipe up heavy soil on the oven bottom.

Cleaning the Glass Cooktop

Normal Daily Use Cleaning

ONLY use CERAMA BRYTE® Ceramic Cooktop Cleaner on the glass cooktop. Other creams may not be as effective.

To maintain and protect the surface of your glass cooktop, follow these steps:

1. Before using the cooktop for the first time, clean it with CERAMA BRYTE® Ceramic Cooktop Cleaner. This helps protect the top and makes cleanup easier.
2. Daily use of CERAMA BRYTE® Ceramic Cooktop Cleaner will help keep the cooktop looking new.
3. Shake the cleaning cream well. Apply a few drops of CERAMA BRYTE® Ceramic Cooktop Cleaner directly to the cooktop.

4. Use a paper towel or CERAMA BRYTE® Cleaning Pad for Ceramic Cooktops to clean the entire cooktop surface.
5. Use a dry cloth or paper towel to remove all cleaning residue. No need to rinse.



Clean your cooktop after each spill. Use CERAMA BRYTE® Ceramic Cooktop Cleaner.

NOTE: It is very important that you DO NOT heat the cooktop until it has been cleaned thoroughly.

Burned-On Residue

NOTE: DAMAGE to your glass surface may occur if you use scrub pads other than those recommended.

1. Allow the cooktop to cool.
2. Spread a few drops of CERAMA BRYTE® Ceramic Cooktop Cleaner on the entire burned residue area.
3. Using the included CERAMA BRYTE® Cleaning Pad for Ceramic Cooktops, rub the residue area, applying pressure as needed.
4. If any residue remains, repeat the steps listed above as needed.

5. For additional protection, after all residue has been removed, polish the entire surface with CERAMA BRYTE® Ceramic Cooktop Cleaner and a paper towel.

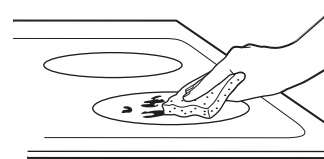

Use a CERAMA BRYTE® Cleaning Pad for Ceramic Cooktops.

Heavy, Burned-On Residue

1. Allow the cooktop to cool.
2. Use a single-edge razor blade scraper at approximately a 45° angle against the glass surface and scrape the soil. It will be necessary to apply pressure to the razor scraper in order to remove the residue.
3. After scraping with the razor scraper, spread a few drops of CERAMA BRYTE® Ceramic Cooktop Cleaner on the entire burned residue area. Use the CERAMA BRYTE® Cleaning Pad to remove any remaining residue.
4. For additional protection, after all residue has been removed, polish the entire surface with CERAMA BRYTE® Ceramic Cooktop Cleaner and a paper towel.

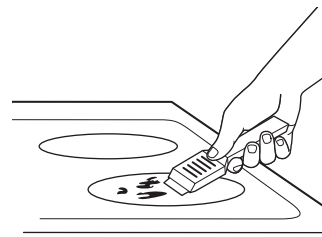

The CERAMA BRYTE® Ceramic Cooktop Scraper and all recommended supplies are available through our Parts Center. See the Accessories and Consumer Support sections at the end of this manual.

NOTE: Do not use a dull or nicked blade.

Cleaning the Glass Cooktop (Cont.)

Metal Marks and Scratches

1. Be careful not to slide pots and pans across your cooktop. It will leave metal markings on the cooktop surface.

These marks are removable using the CERAMA BRYTE® Ceramic Cooktop Cleaner with the CERAMA BRYTE® Cleaning Pad for Ceramic Cooktops.

2. If pots with a thin overlay of aluminum or copper are allowed to boil dry, the overlay may leave black discoloration on the cooktop.

This should be removed immediately before heating again or the discoloration may be permanent.

NOTE: Carefully check the bottom of pans for roughness that would scratch the cooktop.

Damage from Sugary Spills and Melted Plastic

Special care should be taken when removing hot substances **to avoid permanent damage of the glass surface**. Sugary spillovers (such as jellies, fudge, candy, syrups) or melted plastics can cause pitting of the surface of your cooktop (not covered by the warranty) unless the spill is removed while still hot. Special care should be taken when removing hot substances.

Be sure to use a new, sharp razor scraper.

Do not use a dull or nicked blade.

1. Turn off all surface units. Remove hot pans.
2. Wearing an oven mitt:
 - a. Use a single-edge razor blade scraper to move the spill to a cool area on the cooktop.
 - b. Remove the spill with paper towels.

3. Any remaining spillover should be left until the surface of the cooktop has cooled.

4. Don't use the surface units again until all of the residue has been completely removed.

NOTE: If pitting or indentation in the glass surface has already occurred, the cooktop glass will have to be replaced. In this case, service will be necessary.

Oven Light

⚠ WARNING SHOCK OR BURN HAZARD: Before replacing oven light bulb, disconnect the electrical power to the range at the main fuse or circuit breaker panel. Failure to do so may result in electric shock or burn.

⚠ CAUTION BURN HAZARD: The glass cover and bulb should be removed when cool. Touching hot glass with bare hands or a damp cloth can cause burns.

Oven Light Replacement

To remove:

1. Turn the glass cover counterclockwise 1/4 turn until the tabs of the glass cover clear the grooves of the socket. Wearing latex gloves may offer a better grip.
2. Remove the bulb by turning it counter-clockwise.

To replace:

1. Replace bulb with a new 40-watt appliance bulb. Insert the bulb and turn it clockwise until it is tight.
2. Place the tabs of the glass cover into the grooves of the socket. Turn the glass cover clockwise 1/4 turn.

For improved lighting inside the oven, clean the glass cover frequently using a wet cloth. This should be done when the oven is completely cool.

3. Reconnect electrical power to the oven.

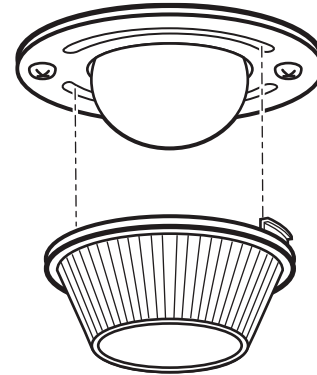

Oven Door

The door is very heavy. Be careful when removing and lifting the door.

Do not lift the door by the handle.

To remove the door:

1. Fully open the door.
2. Pull the hinge locks down toward the door frame, to the unlocked position. A tool, such as a small flat-blade screwdriver, may be required.
3. Firmly grasp both sides of the door at the top.
4. Close door to the door removal position. The door should be open approximately 3" with no obstruction above the door.
5. Lift door up and out until both hinge arms are clear of the slots.

To replace the door:

1. Firmly grasp both sides of the door at the top.
2. Starting on the left side, with the door at the same angle as the removal position, seat the indentation of the hinge arm into the bottom edge of the hinge slot. The notch in the hinge arm must be fully seated into the bottom of the slot. Repeat for right side.
3. Fully open the door. If the door will not fully open, the indentation is not seated correctly in the bottom edge of the slot.
4. Push the hinge locks up against the front frame of the oven cavity, to the locked position.
5. Close the oven door.

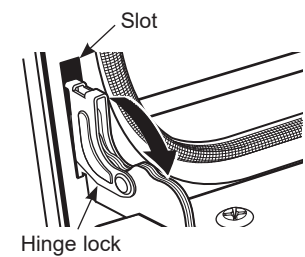

Pull hinge locks down to unlock

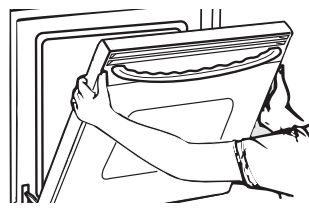

Removal position

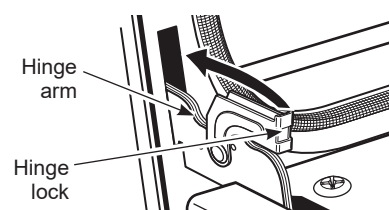

Push hinge locks up to lock

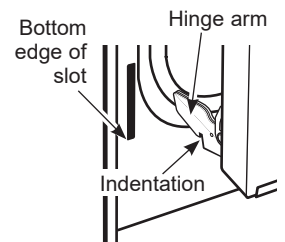

Troubleshooting Tips ... Before you call for service

Save time and money! Review the charts on the following pages first and you may not need to call for service.

Problem	Possible Cause	What To Do
Surface units will not maintain a rolling boil or cooking is not fast enough	Improper cookware being used.	Use pans which are flat and match the diameter of the surface unit selected.
	In some areas, the power (voltage) may be low.	Cover pan with a lid until desired heat is obtained.
Surface units do not work properly	A fuse in your home may be blown or the circuit breaker tripped.	Replace the fuse or reset the circuit breaker.
	Cooktop controls improperly set.	Check to see the correct control is set for the surface unit you are using.
Surface unit stops glowing when turned to a lower setting	The unit is still on and hot.	This is normal.
Scratches (may appear as cracks) on cooktop glass surface	Incorrect cleaning methods being used.	Scratches are not removable. Tiny scratches will become less visible in time as a result of cleaning.
	Cookware with rough bottoms being used or coarse particles (salt or sand) were between the cookware and the surface of the cooktop. Cookware has been slid across the cooktop surface.	To avoid scratches, use the recommended cleaning procedures. Make sure bottoms of cookware are clean before use, and use cookware with smooth bottoms.
Areas of discoloration on the cooktop	Food spillovers not cleaned before next use.	See the Cleaning the glass cooktop section.
	Hot surface on a model with a light-colored cooktop.	This is normal. The surface may appear discolored when it is hot. This is temporary and will disappear as the glass cools.
Plastic melted to the surface	Hot cooktop came into contact with plastic placed on the hot cooktop.	See the Cleaning the glass cooktop section as there is potential for permanent damage without proper care.
Pitting (or indentation) of the cooktop	Hot sugar mixture spilled on the cooktop.	Call a qualified technician for replacement.
Frequent cycling off and on of surface units	Improper cookware being used.	Use only flat cookware to minimize cycling.
My new oven doesn't cook like my old one. Is something wrong with the temperature settings?	Your new oven has a different cooking system from your old oven and therefore may cook differently than your old oven.	For the first few uses, follow your recipe times and temperatures carefully. If you still think your new oven is too hot or too cold, you can adjust the temperature yourself by following the steps in Special Features to meet your specific cooking preference. NOTE: This adjustment affects Bake and Convection Bake temperatures; it will not affect Convection Roast, Broil or Clean.
Food does not bake properly	Oven controls improperly set.	See the Cooking Modes section.
	Rack position is incorrect or rack is not level.	See the Cooking Modes section and Cooking Guide.
	Incorrect cookware or cookware of improper size being used.	See the Cookware section.
	Oven temperature needs adjustment.	See the Special Features section.
	Ingredient substitution	Substituting ingredients can change the recipe outcome.
Food does not broil properly	Oven controls improperly set.	Make sure you select the appropriate broil mode.
	Improper rack position being used.	See Cooking Guide for rack location suggestions.
	Food being cooked in a hot pan.	Make sure cookware is cool.
	Cookware not suited for broiling.	Use a pan specifically designed for broiling.
	Aluminum foil used on the broiling pan and grid has not been fitted properly and slit as recommended.	If using aluminum foil conform to pan slits.
	In some areas the power (voltage) may be low.	Preheat the broil element for 10 minutes.
Oven temperature too hot or too cold	Oven temperature needs adjustment.	See the Special Features section.

Troubleshooting Tips ... Before you call for service

Problem	Possible Cause	What To Do
Oven does not work or appears not to work	A fuse in your home may be blown or the circuit breaker tripped.	Replace the fuse or reset the circuit breaker.
	Oven controls improperly set.	See the Using the Oven section.
	Oven is in Sabbath Mode.	Verify that the oven is not in Sabbath Mode. See the Special Features section.
“Crackling” or “popping” sound	This is the sound of the metal heating and cooling during both the cooking and cleaning functions.	This is normal.
Why is my range making a “clicking” noise when using my oven?	Your range cycles the heating elements by turning relays on and off to maintain the oven temperature.	This is normal.
Clock and timer do not work	A fuse in your home may be blown or the circuit breaker tripped.	Replace the fuse or reset the circuit breaker.
	Plug on range is not completely inserted in the electrical outlet.	Make sure electrical plug is plugged into a live, properly grounded outlet.
	Oven controls improperly set.	See the Using the kitchen timer section.
	Clock display turned off	Check Clock Display settings in the Special Features section
Storage drawer won’t close	Power cord may be obstructing drawer in the lower back of the range.	Reposition the drawer and power cord. See the Storage Drawer Removal instructions in the Care and cleaning of the range section.
	Drawer slide or rail improperly aligned with support	Reposition the drawer. See the Storage Drawer Removal instructions in the Care and cleaning of the range section.
Oven door is crooked	The door is out of position.	Because the oven door is removable, it sometimes gets out of position during installation. To straighten the door, re-install the door. See the Lift-Off Oven Door instructions in the Care and Cleaning section.
Oven light does not work	Light bulb is loose or defective.	Tighten or replace bulb.
	Pad operating light is broken.	Call for service.
	Oven is in Sabbath mode	Verify that the oven is not in Sabbath mode. See the Special Features section.
Oven will not self-clean	The temperature is too high to set a self-clean operation.	Allow the oven to cool and reset the controls.
	Oven controls improperly set.	See the Cleaning the Oven section.
	Door not shut/closed	Close the oven door completely.
Excessive smoking during clean cycle	Excessive soil or grease.	Press the Cancel/Off pad. Open the windows to rid the room of smoke. Wait until the LOCKED light goes off. Wipe up the excess soil and reset the clean cycle.
Excessive smoking during broiling	Food too close to burner element.	Lower the rack position of the food.
Oven door will not open after a clean cycle	Oven too hot.	Allow the oven to cool below locking temperature.
Oven not clean after a clean cycle	Oven controls improperly set.	See the Cleaning the Oven section.
	Oven was heavily soiled.	Clean up heavy spillovers before starting the clean cycle. Heavily soiled ovens may need to self-clean again or for a longer period of time.
“LOCK DOOR” flashes in the display	The self-clean cycle has been selected but the door is not closed.	Close the oven door. Latch the door for units that have a manual latch.
DOOR LOCK light is on when you want to cook	The oven door is locked because the temperature inside the oven has not dropped below the locking temperature.	Press the Cancel/Off pad. Allow the oven to cool.
“F— and a number or letter” flash in the display	You have a function error code.	Press the Cancel/Off pad. Allow the oven to cool for one hour. Put the oven back into operation.
	If the function code repeats.	Disconnect all power to the oven for at least 30 seconds and then reconnect power. If the function error code repeats, call for service.

Troubleshooting Tips ... Before you call for service

Problem	Possible Cause	What To Do
Display goes blank	A fuse in your home may be blown or the circuit breaker tripped.	Replace the fuse or reset the circuit breaker.
	The clock is turned off.	See the Special features section.
Power outage, clock flashes	Power outage or surge	Reset the clock. If the oven was in use, you must reset it by pressing the Cancel/Off pad, setting the clock and resetting any cooking function.
“Burning” or “oily” odor emitting from the vent	This is normal in a new oven and will disappear in time.	To speed the process, set a self-clean cycle for a minimum of 3 hours. See the Cleaning the Oven section.
Strong odor	An odor from the insulation around the inside of the oven is normal for the first few times the oven is used.	This is temporary and will go away after several uses or a self-clean cycle.
Fan noise	A convection fan may automatically turn on and off.	This is normal on some models. The fan is designed to operate intermittently to maximize cooking evenness. The convection fan will operate during preheat of the bake cycle. The fan will turn off after the oven is heated to the set temperature. This is normal.
	A cooling fan may automatically turn on	This is normal on some models. The cooling fan will turn off and on to cool internal parts. It may run after the oven is turned off.
My oven door glass appears to be “tinted” or have a “rainbow” color. Is this defective?	No. The inner oven glass is coated with a heat barrier to reflect the heat back into the oven to prevent heat loss and keep the outer door cool while baking.	This is normal. Under certain light or angles, you may see this tint or rainbow color.
Sometimes the oven takes longer to preheat to the same temperature	Cookware or food in oven.	The cookware or food in the oven will cause the oven to take longer to preheat. Remove items to reduce preheat time.
	Number of racks in oven.	Adding more racks to the oven will cause the oven to take longer to preheat. Remove some racks.
	Different cooking modes.	The different cooking modes use different preheat methods to heat the oven for the specific cooking mode. Some modes will take longer than others (i.e. convection bake).
Display flashes	Power failure.	Reset the clock.
Unable to get the display to show “oFFSEt”	Oven control pads were not touched properly.	The Broil Hi/Lo and Bake pads must be touched at the same time and held for 3 seconds.
Control signals after entering cooking time or start time	You forgot to enter a bake temperature or cleaning time.	Touch the Bake pad and desired temperature or the Self Clean pad and desired clean time.
Oven racks are difficult to slide	The shiny, silver-colored racks were cleaned in a self-clean cycle.	Apply a small amount of vegetable oil to a paper towel and wipe the edges of the oven racks with the paper towel. Do not spray with Pam® or other lubricant sprays.
Drawer does not slide smoothly or drags	The drawer is out of alignment.	Fully extend the drawer and push it all the way in See the Care and cleaning of the range section.
	Drawer is over-loaded or load is unbalanced.	Reduce weight. Redistribute drawer contents.
Steam from the vent	When using the ovens, it is normal to see steam coming out of the oven vents. As the number of racks or amount of food being cooked increases, the amount of visible steam will increase.	This is normal.
Water remaining on oven floor after Steam Clean cycle	This is normal.	Remove any remaining water with a dry cloth or sponge.
Oven will not steam clean	Display flashes HOT.	Allow the oven to cool to room temperature and reset the controls.
	Oven controls improperly set.	See the Using Steam Clean section.
	Oven door is not closed.	Make sure you close the door to start steam clean cycle.

GE Appliances Electric Range Warranty

GEAppliances.ca

All warranty service is provided by our Factory Service Centers, or an authorized Customer Care® technician. To schedule service online, visit us at www.GEAppliances.ca, or call 1.800.561.3344. Please have your serial number and your model number available when calling for service.

Servicing your appliance may require the use of the onboard data port for diagnostics. This gives a GE Appliances factory service technician the ability to quickly diagnose any issues with your appliance and helps GE Appliances improve its products by providing GE Appliances with information on your appliance. If you do not want your appliance data to be sent to GE Appliances, please advise your technician not to submit the data to GE Appliances at the time of service.

For the period of	MC Comercial Will Provide:
One year From the date of the original purchase	Any part of the range which fails due to a defect in materials or workmanship. During this limited one-year warranty , MC Comercial will provide, free of charge , all labor and in-home service to replace the defective part.

What MC Comercial will not cover:

- Service trips to your home to teach you how to use the product.
- Improper installation, delivery or maintenance.
- Failure of the product if it is abused, misused, modified or used for other than the intended purpose or used commercially.
- Damage to the glass cooktop caused by use of cleaners other than the recommended cleaning creams and pads.
- Damage to the glass cooktop caused by hardened spills of sugary materials or melted plastic that are not cleaned according to the directions in the Owner's Manual.
- Replacement of house fuses or resetting of circuit breakers.
- Damage to the product caused by accident, fire, floods or acts of God.
- Damage to finish, such as surface rust, tarnish, or small blemishes not reported within 48 hours of delivery.
- Incidental or consequential damage caused by possible defects with this appliance.
- Damage caused after delivery.
- Product not accessible to provide required service.
- Service to repair or replace light bulbs, except for LED lamps.

EXCLUSION OF IMPLIED WARRANTIES

Your sole and exclusive remedy is product repair as provided in this Limited Warranty. Any implied warranties, including the implied warranties of merchantability or fitness for a particular purpose, are limited to one year or the shortest period allowed by law.

This warranty is extended to the original purchaser and any succeeding owner for products purchased in Canada for home use within Canada. If the product is located in an area where service by a GE Authorized Servicer is not available, you may be responsible for a trip charge or you may be required to bring the product to an Authorized GE Service location.

Some provinces do not allow the exclusion or limitation of incidental or consequential damages. This warranty gives you specific legal rights, and you may also have other rights which vary from province to province. To know what your legal rights are, consult your local or provincial consumer affairs office.

Warrantor: MC Comercial, Burlington, ON, L7R 5B6

Staple your receipt here. Proof of the original purchase date is needed to obtain service under the warranty.

Accessories

Looking For Something More?

GE Appliances offers a variety of accessories to improve your cooking and maintenance experiences!

Refer to the Consumer Support page for phone numbers and website information.

The following products and more are available:

Accessories

Small Broiler Pan (8 ¾" x 1 ¼" x 13 ½")

Large Broiler Pan (12 ¾" x 1 ¼" x 16 ½")

XL Broiler Pan (17" x 1 ¼" x 19 1/4")

Parts

Oven racks

Oven elements

Light bulbs

Cleaning Supplies

CitruShine™ Stainless Steel Wipes

CERAMA BRYTE® Stainless Steel Appliance Cleaner

CERAMA BRYTE® Cleaning Pads for Ceramic Cooktops

CERAMA BRYTE® Ceramic Cooktop Cleaner

CERAMA BRYTE® Ceramic Cooktop Scraper

Kit (Kit includes cream and cooktop scraper)

*The large broiler pan does not fit in 20"/24" ranges.

** The XL broiler pan does not fit in 24" wall ovens, 27" drop-ins or 20"/24" range.

Consumer Support

GE Appliances Website

Have a question or need assistance with your appliance? Try the GE Appliances Website 24 hours a day, any day of the year! You can also shop for more great GE Appliances products and take advantage of all our on-line support services designed for your convenience. In the US: GEAppliances.ca

Register Your Appliance

Register your new appliance on-line at your convenience! Timely product registration will allow for enhanced communication and prompt service under the terms of your warranty, should the need arise. You may also mail in the pre-printed registration card included in the packing material. In the US: GEAppliances.ca

Schedule Service

Expert GE Appliances repair service is only one step away from your door. Get on-line and schedule your service at your convenience any day of the year. In the US: GEAppliances.ca or call **1-800.561.3344** during normal business hours.

Remote Connectivity

For assistance with wireless network connectivity (for models with remote enable), visit our website at GEAppliances.com/ge/connected-appliances/ or call 800.220.6899 in the US.

Parts and Accessories

Individuals qualified to service their own appliances can have parts or accessories sent directly to their homes (VISA, MasterCard and Discover cards are accepted). Order on-line today 24 hours every day. In the US: GEApplianceparts.com or by phone at 877.959.8688 during normal business hours.

Instructions contained in this manual cover procedures to be performed by any user. Other servicing generally should be referred to qualified service personnel. Caution must be exercised, since improper servicing may cause unsafe operation.

Contact Us

If you are not satisfied with the service you receive from GE Appliances, contact us on our Website with all the details including your phone number, or write to:

MC Comercial | Factory Lane Moncton, New Brunswick E1C 9M3.