

Gaggenau

Use and care manual

# **EB 333 611**

Built-in oven

---

# Table of Contents

---

<b>▲ Safety Definitions</b>	<b>3</b>	<b>Timer functions</b>	<b>18</b>
<b>IMPORTANT SAFETY INSTRUCTIONS</b>	<b>4</b>	Launching the timer menu	18
Proper Installation and Maintenance	4	Timer	18
Fire Safety	5	Stopwatch	18
Burn Prevention	6	Cooking time	19
Child Safety	6	End of cooking time	20
Cleaning Safety	7	<b>Sabbath mode and Yom Tov mode</b>	<b>21</b>
Cookware Safety	7	Sabbath mode	21
Proposition 65 Warning	8	Yom Tov mode	21
<b>Causes of damage</b>	<b>9</b>	<b>Automatic programs</b>	<b>22</b>
<b>Environmental protection</b>	<b>9</b>	Information on the settings	22
Tips for saving energy	9	Selecting a dish	23
<b>Familiarizing yourself with your appliance</b>	<b>10</b>	Applying settings for dishes	23
Oven	10	Calling up the last automatic programs used	23
Displays and controls	11	<b>Personal recipes</b>	<b>24</b>
Symbols	11	Recording a recipe	24
Colors and display	11	Programming a recipe	24
Standby	12	Entering a name	25
Activate appliance	12	Starting a recipe	25
Additional information <b>i</b> and <b>i</b> <sup>®</sup>	12	Change recipe	25
Cooling fan	12	Deleting a recipe	25
Program selection positions	13	<b>Core temperature probe</b>	<b>26</b>
Accessories	14	Inserting the core temperature probe into the food	26
Special accessories	15	Setting the core temperature	27
<b>Before using the appliance for the first time</b>	<b>15</b>	Core temperature guidelines	28
Setting the language	15	<b>Rotisserie spit</b>	<b>29</b>
Setting the time format	15	Preparation	29
Setting the time	15	Switching on the rotisserie spit	30
Setting the date format	16	Switching off the rotisserie spit	31
Setting the date	16	<b>Roasting function</b>	<b>31</b>
Setting the temperature unit	16	<b>Childproof lock</b>	<b>31</b>
Completing initial set-up	16	Activating the child lock	31
Heating up the oven	16	Deactivating the child lock	31
Cleaning accessories	16	<b>Home Connect</b>	<b>32</b>
<b>Operating the appliance</b>	<b>16</b>	Setting Up	32
Oven interior	16	Remote Start	33
Inserting the rack	16	Home Connect settings	33
Turning on	17	Remote Diagnostics	34
Quick heat	17	Information on Data Protection	34
Safety shut-off	17	Declaration of Conformity	34
		Wi-Fi <sup>®</sup> Module	34

<b>Basic settings</b>	<b>36</b>
<b>Cleaning and maintenance</b>	<b>38</b>
Cleaning agents	38
Removing the plug-in grid	39
<b>Pyrolysis (self-cleaning)</b>	<b>40</b>
Preparing the pyrolytic self-cleaning feature	40
Starting the pyrolytic self-cleaning function	41
Cleaning the Accessories with the Pyrolytic Self-cleaning Feature	41
<b>Troubleshooting</b>	<b>42</b>
Power cut	42
Demo mode	42
Replacing the oven lamp	43
<b>Customer service</b>	<b>44</b>
<b>Tables and tips</b>	<b>44</b>
Vegetables	45
Side dishes and dishes	46
Fish	48
Meat	49
Poultry	52
Grilling and roasting	53
Baked goods	54
Dough proving (leaving to rise)	58
Desserts	58
Defrosting	59
Preserving	60
Disinfecting	60
Drying	60
Baking stone	61
Roasting dish	62
Acrylamide in foodstuffs	63

Additional information on products, accessories, replacement parts and services can be found at [www.gaggenau.com](http://www.gaggenau.com) and in the online shop [www.gaggenau.com/zz/store](http://www.gaggenau.com/zz/store)

---

## Safety Definitions

---

### WARNING

This indicates that death or serious injuries may occur as a result of non-observance of this warning.

---

### CAUTION

This indicates that minor or moderate injuries may occur as a result of non-observance of this warning.

---

### **NOTICE**

This indicates that damage to the appliance or property may occur as a result of non-compliance with this advisory.

---

**Note:** This alerts you to important information and/or tips.

# **IMPORTANT SAFETY INSTRUCTIONS**

READ AND SAVE THESE INSTRUCTIONS

---

## **WARNING**

When properly cared for, your new appliance has been designed to be safe and reliable. Read all instructions carefully before use. These precautions will reduce the risk of burns, electric shock, fire, and injury to persons. When using kitchen appliances, basic safety precautions must be followed, including those in the following pages.

---

### **Proper Installation and Maintenance**

Have the installer show you the location of the circuit breaker or fuse. Mark it for easy reference.

This appliance must be properly installed and grounded by a qualified technician. Connect only to properly grounded outlet. Refer to Installation Instructions for details.

This appliance is intended for normal family household use only. It is not approved for outdoor use. See the Statement of Limited Product Warranty. If you have any questions, contact the manufacturer.

Do not store or use corrosive chemicals, vapors, flammables or nonfood products in or near this appliance. It is specifically designed for use when heating or cooking food. The use of corrosive chemicals in heating or cleaning will damage the appliance and could result in injury.

Do not operate this appliance if it is not working properly, or if it has been damaged. Contact an authorized servicer.

Do not obstruct oven vents.

Do not repair or replace any part of the appliance unless specifically recommended in this manual. Refer all servicing to an authorized servicer.

---

## **WARNING**

**Risk of burns!**

To avoid risk of injury, turn off the interior light before cleaning the oven to allow the bulbs to cool down. The bulbs can become very hot when switched on. Keep the light off while cleaning the oven.

---

---

## **WARNING**

Make sure the appliance and lights are cool and power to the appliance has been turned off before replacing the light bulb(s). Failure to do so could result in electrical shock or burns. The lenses (if equipped) must be in place when using the appliance. The lenses (if equipped) serve to protect the light bulb from breaking. The lenses (if equipped) are made of glass. Handle carefully to avoid breaking. Broken glass can cause an injury.

---

# IMPORTANT SAFETY INSTRUCTIONS

READ AND SAVE THESE INSTRUCTIONS

---

## WARNING

Light socket is live when door is open if main power supply is not turned off.

---

## Fire Safety

---

## WARNING

NEVER cover any slots, holes or passages in the oven bottom or cover an entire rack with materials such as aluminum foil. Doing so blocks air flow through the oven. Aluminum foil linings may also trap heat, causing a fire hazard.

---

If materials inside an oven or warming drawer should ignite, keep door closed. Turn off the appliance and disconnect the circuit at the circuit breaker box.

---

## WARNING

Use this appliance only for its intended use as described in this manual. NEVER use this appliance as a space heater to heat or warm the room. Doing so may result in overheating the appliance. Never use the appliance for storage.

---

Always have a working smoke detector near the kitchen.

In the event that personal clothing or hair catches fire, drop and roll immediately to extinguish flames.

Have an appropriate fire extinguisher available, nearby, highly visible and easily accessible near the appliance.

Smother flames from food fires other than grease fires with baking soda. Never use water on cooking fires.

---

## WARNING

TO REDUCE THE RISK OF INJURY TO PERSONS IN THE EVENT OF A GREASE FIRE, OBSERVE THE FOLLOWING:

1. **SMOTHER FLAMES** with a close-fitting lid, cookie sheet, or metal tray, then turn off the burner. **BE CAREFUL TO PREVENT BURNS.** If the flames do not go out immediately, **EVACUATE AND CALL THE FIRE DEPARTMENT.**
  2. **NEVER PICK UP A FLAMING PAN** – You may be burned.
  3. **DO NOT USE WATER**, including wet dishcloths or towels – a violent steam explosion will result.
  4. Use an extinguisher **ONLY** if:
    - You know you have a Class ABC extinguisher, and you already know how to operate it.
    - The fire is small and contained in the area where it started.
    - The fire department is being called.
    - You can fight the fire with your back to an exit.
-



# IMPORTANT SAFETY INSTRUCTIONS

READ AND SAVE THESE INSTRUCTIONS

## Burn Prevention

**DO NOT TOUCH HEATING ELEMENTS OR INTERIOR SURFACES OF OVEN -** Heating elements may be hot even though they are dark in color. Interior surfaces of an oven become hot enough to cause burns. During and after use, do not touch, or let clothing, potholders, or other flammable materials contact heating elements or interior surfaces of oven until they have had sufficient time to cool. Other surfaces of the appliance may become hot enough to cause burns. Among these surfaces are oven vent openings, surfaces near these openings and oven doors.

Exercise caution when opening the appliance. Standing to the side, open the door (or drawer) slowly and slightly to let hot air and/or steam escape. Keep your face clear of the opening and make sure there are no children or pets near the unit. After the release of hot air and/or steam, proceed with your cooking. Keep doors shut unless necessary for cooking or cleaning purposes. Do not leave open doors unattended.

Do not heat or warm unopened food containers. Build-up of pressure may cause the container to burst and cause injury.

Use caution when cooking foods with high alcohol content (e.g. rum, brandy, bourbon) in the oven. Alcohol evaporates at high temperatures. There is a risk of burning as the alcohol vapors may catch fire in the oven. Use only small quantities of alcohol in foods, and open the oven door carefully.

Always place oven racks in desired location while oven is cool. Always use oven mitts, when the oven is warm. If a rack must be moved while oven is hot, do not let potholder contact the heating elements.



## CAUTION

To avoid possible injury or damage to the appliance, ensure rack is installed exactly per installation instructions and not backwards or upside down.

---

Always use dry potholders. Moist or damp potholders on hot surfaces may result in burns from steam. Do not let potholder touch hot heating elements. Do not use a towel or other bulky cloth.

Secure all loose garments, etc. before beginning. Tie long hair so that it does not hang loose, and do not wear loose fitting clothing or hanging garments, such as ties, scarves, jewelry, or dangling sleeves.

## Child Safety

When children become old enough to use the appliance, it is the responsibility of the parents or legal guardians to ensure that they are instructed in safe practices by qualified persons.

Do not allow anyone to climb, stand, lean, sit, or hang on any part of an appliance, especially a door, warming drawer, or storage drawer. This can damage the appliance, and the unit may tip over, potentially causing severe injury.

# **IMPORTANT SAFETY INSTRUCTIONS**

READ AND SAVE THESE INSTRUCTIONS

Do not allow children to use this appliance unless closely supervised by an adult. Children and pets should not be left alone or unattended in the area where the appliance is in use. They should never be allowed to play in its vicinity, whether or not the appliance is in use.

---

## **CAUTION**

Items of interest to children should not be stored in an appliance, in cabinets above an appliance or on the backsplash. Children climbing on an appliance to reach items could be seriously injured.

---

## **Cleaning Safety**

**IMPORTANT SAFETY NOTICE:** The California Safe Drinking Water and Toxic Enforcement Act requires the Governor of California to publish a list of substances known to the state to cause cancer, birth defects or other reproductive harm, and requires businesses to warn customers of potential exposure to such substances. The burning of gas cooking fuel and the elimination of soil during self-cleaning can generate some by-products which are on the list. To minimize exposure to these substances, always operate this unit according to the instructions contained in this booklet and provide good ventilation.

When self-cleaning, confirm that the door locks and will not open. If the door does not lock, do not run Self-Clean. Contact service.

Wipe out excessive spillage before self-cleaning the oven.

Birds have very sensitive respiratory systems. Keep pet birds out of the kitchen or other rooms where kitchen fumes could reach them. During self-clean, fumes are released that may be harmful to birds. Other kitchen fumes such as overheating margarines and cooking oils may also be harmful.

Keep oven free from grease build up.

## **Cookware Safety**

---

### **NOTICE**

---

Do not place food directly on oven bottom.

---

Follow the manufacturer's directions when using cooking or roasting bags.

---

## **CAUTION**

Do not leave food or cooking utensils, etc., in the oven during the self-cleaning mode of operation.

---

Do not clean parts or accessories in the self-clean oven.

---

## **WARNING**

**Risk of electric shock!**

Use of a wrong core temperature probe can damage the insulation. Use only the core temperature probe intended for this appliance.

---



# IMPORTANT SAFETY INSTRUCTIONS

READ AND SAVE THESE INSTRUCTIONS

## Proposition 65 Warning:

This product may contain a chemical known to the State of California, which can cause cancer or reproductive harm. Therefore, the packaging of your product may bear the following label as required by California:

STATE OF CALIFORNIA PROPOSITION 65 WARNING:



**WARNING**

Cancer and Reproductive Harm - [www.P65Warnings.ca.gov](http://www.P65Warnings.ca.gov)

## Remote Operation

This appliance is configurable to allow remote operation at any time. Do not store any flammable materials or temperature sensitive items inside, on top or near surface units of the appliance.



---

## Causes of damage

---

**NOTICES:**

- Accessories, foil, baking paper or cookware on the bottom of the oven interior: do not place any accessories on the bottom of the oven interior. Do not line the bottom of the oven interior with any type of foil or baking paper. Do not place cookware on the bottom of the oven interior when a temperature above 122°F (50 °C) is set. This produces a build-up of heat. Baking and roasting times are no longer correct and the enamel is damaged.
- Water in the hot oven interior: Never pour water into the hot oven interior. Steam is produced. Damage to the enamel can arise due to the temperature change.
- Do not leave moist groceries in a closed oven for an extended period of time. It can lead to corrosion inside the oven.
- Fruit juice can leave stains in the oven. Always remove fruit juice immediately when safe to touch, and wipe up first with a damp and then a dry cloth.
- Cooling with the appliance door open: only allow the oven cavity to cool when it is closed. Even if the appliance door is only open a little, front panels of adjacent units could be damaged over time.
- Highly soiled door seal: the appliance door will no longer close properly during operation if the door seal is highly soiled. Adjoining furniture fronts may be damaged. Always keep the door seal clean.
- Appliance door as a seat or storage surface: do not stand, sit or hang on the appliance door. Do not place any cookware or accessories on the appliance door.
- Inserting accessories: depending on the appliance type, accessories can scratch the door pane when closing the appliance door. Always slide accessories fully into the oven interior.
- Do not hold or carry the appliance by the door handle. The door handle cannot carry the weight of the device and could break off.

---

## Environmental protection

---

Unpack the appliance and dispose of the packaging in an environmentally friendly manner.

**Tips for saving energy**

- Open the appliance door as little as possible while cooking, baking or roasting.
- Use dark, black-painted or enameled baking forms. These absorb the heat particularly well.
- It is best to bake several cakes in succession. The oven is still warm. This shortens the baking time for the second cake. You can also slide in two loaf tins next to each other.
- In the hot air mode, you can bake simultaneously on several levels.
- For longer cooking times, you can switch off the oven 10 minutes before the end of the cooking time and you can use the residual heat to finish cooking.

---

## Familiarizing yourself with your appliance

---

You will get to know your new appliance here. We explain the control panel and the individual controls to you. You are informed about the oven interior and accessories.

### Oven

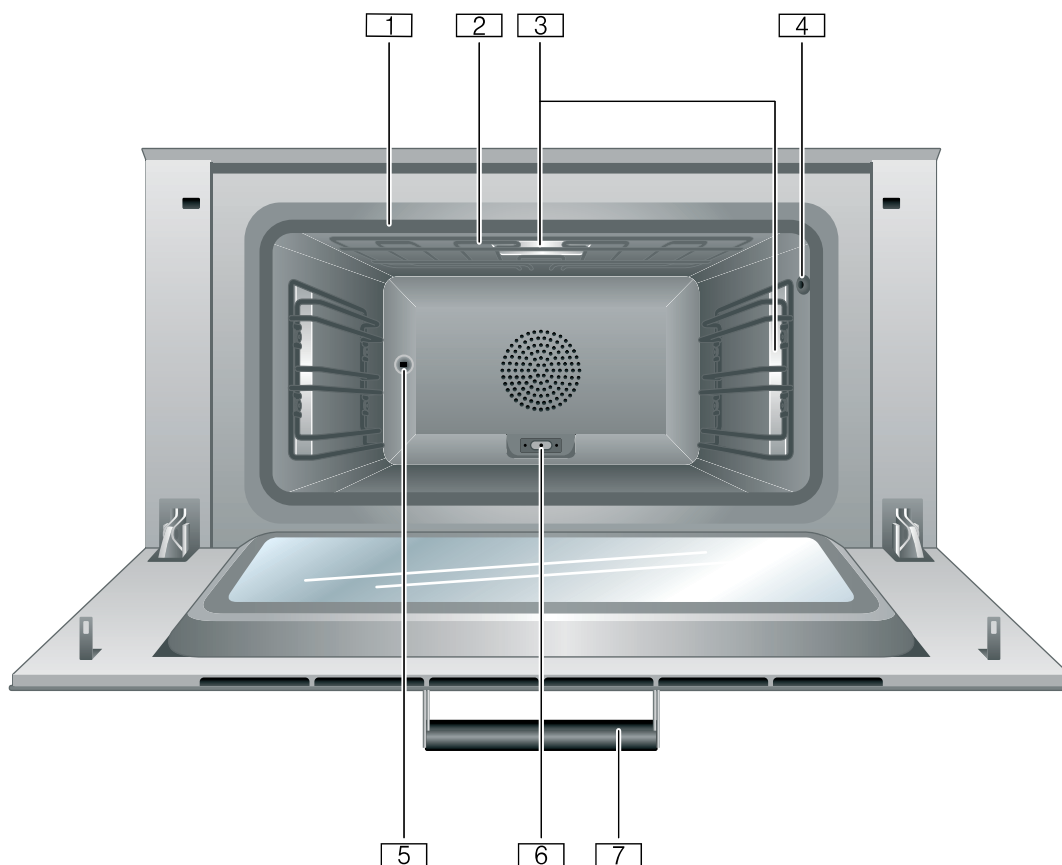

- 
- |   |  |
|---|--|
| 1 | Door seal  |
| 2 | Grill element  |
| 3 | Interior lighting  |
| 4 | Socket for core temperature probe  |
| 5 | Rotary spit drive  |
| 6 | Opening for additional heating element (optional accessory for the baking stone and roasting dish) |
| 7 | Door handle  |
- 

---

#### **NOTICE**

---

Do not place food directly on oven bottom.

---

Do not obstruct oven vents.

## Displays and controls

These instructions apply to different versions of the appliance. Slight deviations are possible depending on the appliance type.

Operation is identical for all appliance versions.

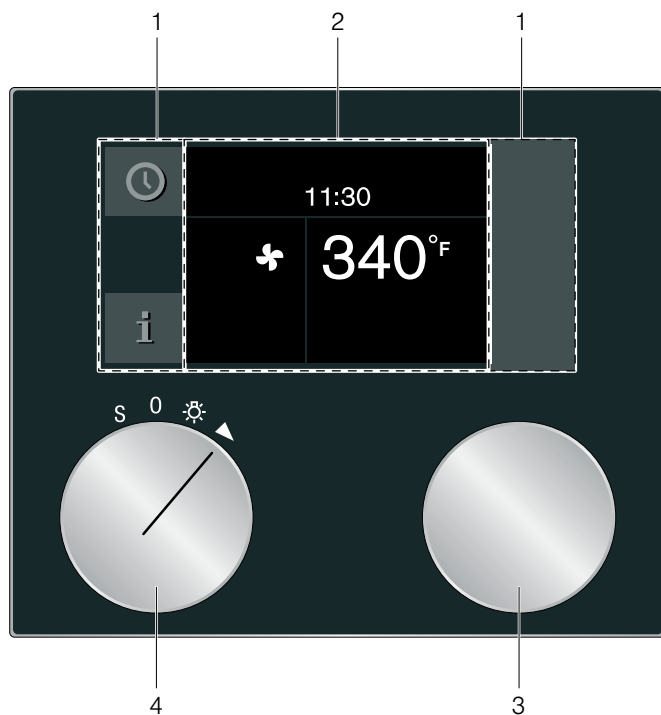

1	Control panel	These areas are touch-sensitive. Touch a symbol to select the applicable function.
2	Display	The display shows current settings and options, for example.
3	Rotary selector	With the rotary selector you can select the temperature and make other settings.
4	Program selector	With the program selector, you can select the heating function, the cleaning function or the basic settings.

## Symbols

Symbol	Function
▶	Start
■	Stop
	Pause/end
X	Cancel
C	Delete
✓	Confirm/save settings
>	Selection arrow
i	Launching additional information
»	Quick heating with status indicator

📖	Calling up automatic programs or individual recipes
rec	Recording a menu
↵	Edit settings
>A <sup>+</sup>	Enter a name
⌫	Delete letters
🔒	Child lock
🕒	Launching the timer menu
🕒	Launching the Sabbath mode
🔧	Demo mode
🌡	Core temperature probe
🍖	Start rotisserie spit
🍖	Stop rotisserie spit
»	Start pre-roast stage
»	End pre-roast stage
📶	Network connection (Home Connect)

## Colors and display

### Colors

The various colors serve to guide you in the various adjustment situations.

Orange	First settings
	Main functions
Blue	Basic settings
	Cleaning
White	Adjustable values

### Presentation

The presentation of symbols, values or the entire display changes depending on the situation.

Zoom	The display of the setting you are just changing is enlarged.  Just before it elapses, a duration that is just elapsing is enlarged (e.g. the last 60 seconds in the case of timers).
Minimized display screen	After a short time, the display screen is minimized and only the most important things are displayed. This function is the default and can be modified in the basic settings.

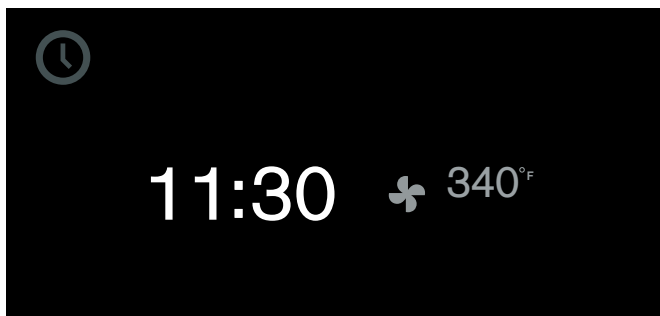

## Standby

The appliance switches to standby mode if no function is set or the childproof lock is activated.

The brightness of the control panel is dimmed in standby mode.

### Notes

- Different things can be displayed in standby mode. The default setting is the GAGGENAU logo and the time.
- The brightness of the display depends on the vertical viewing angle.
- You can change the display and the brightness at any time in the basic settings. → *"Basic settings" on page 36*

## Activate appliance

In order to exit standby mode, you can either

- Set the function selector,
- Touch a control panel,
- or open or close the door.

Now you can set the desired function. Read the appropriate chapters to learn how to set functions.

### Notes

- If "Standby screen = off" is selected in the factory setting, you must turn the function selector to exit the standby mode.
- The standby display appears again if you have not made any settings for a long while after activation.
- The cooking compartment lighting goes out after a little while if the door is open.

## Additional information **i** and **i**<sup>Ⓢ</sup>

By touching the **i** symbol, you can call up additional information. For example, information on the type of heating set or on the current temperature of the cooking compartment.

**Note:** During continuous operation after heating up, slight deviations in temperature are normal.

The **i**<sup>Ⓢ</sup> symbol appears for important information and indicates that an action is required. Important information on safety and operating status is also occasionally displayed automatically. These messages disappear automatically after a few seconds, or must be confirmed with ✓.

With Home Connect messages, the Home Connect status additionally appears in the **i**<sup>Ⓢ</sup>. You will find more information about this in the section entitled → *"Home Connect" on page 32.*

## Cooling fan

Your appliance has a cooling fan. The cooling fan switches on when the appliance is in operation. The fan runs faster at high temperatures and when certain heating functions are running, which produces a louder sound than normal. The hot air escapes beneath the door.

After removing your food from the appliance, keep the door closed until the appliance has cooled down. The appliance door must not be left half open as this may damage adjacent kitchen units. The cooling fan continues running for a certain period after the appliance has stopped heating; afterwards, it switches itself off automatically.

---

### **⚠ CAUTION**







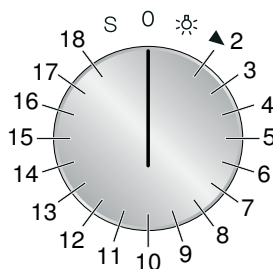



Do not cover the ventilation slots, otherwise the appliance may overheat.

---

## Program selection positions



Position	Function/type of heating	Temperature range Default temperature	Application
0	Off position		
	Light		
2	Convection 	120 - 550°F (50 - 300°C) 340°F (170°C)	Convection: For cakes, cookies and baked casseroles on several levels.  The fan in the rear wall of the oven distributes the heat evenly throughout the cooking compartment.
3	Economy 	120 - 550°F (50 - 300°C) 340°F (170°C)	Energy-saving convection mode for cakes, meat, baked casseroles, and gratins. The convenience features (e.g. the oven lighting) and the catalytic converter remain off. The oven temperature can only be displayed while the oven is heating up. Do not preheat the oven.  Place the food into the cold, empty cooking compartment and start the stated cooking time. Keep the oven door closed during cooking to prevent heat escaping from the oven.
4	Top + bottom heat --- ---	120 - 550°F (50 - 300°C) 340°F (170°C)	For cakes in pans or sheet cakes, baked casseroles, roasting.
5	Top + 1/3 bottom heat --- -	120 - 550°F (50 - 300°C) 340°F (170°C)	For sheet cakes, cookies, cakes with meringue, grilling, and baked casseroles with gratin.  Very well-suited for a situation when the food should be heated from above toward the end of preparation.
6	Top heat ---	120 - 550°F (50 - 300°C) 340°F (170°C)	Targeted heat from above, for example grilling cake topped with fruit and meringue.
7	1/3 top + bottom heat - ---	120 - 550°F (50 - 300°C) 340°F (170°C)	For cheesecake, bread in loaf pans, dishes in a water bath (e.g. egg custard, crème brûlée). For roasting without a lid and warming up foods (foods dry out less).  Very well-suited for a situation when the food should be heated from above toward the end of preparation.
8	Bottom heat ---	120 - 550°F (50 - 300°C) 340°F (170°C)	For the final baking stage (such as for moist cakes topped with fruit), for preserving, for dishes in a water bath.
9	Convection + bottom heat 	120 - 550°F (50 - 300°C) 340°F (170°C)	Additional heat from below for moist cakes, such as cake topped with fruit.

Position	Function/type of heating	Temperature range Default temperature	Application
10	Convection + 1/3 bottom heat 	120 - 550°F (50 - 300°C) 340°F (170°C)	For high baked casseroles, lasagne, onion tart, egg dishes (e.g. tortillas, farmers' omelettes).
11	Broil + circulated air 	120 - 550°F (50 - 300°C) 430°F (220°C)	Even, all-round heating for meat, poultry and whole fish.
12	Broil 	120 - 550°F (50 - 300°C) 430°F (220°C)	To grill flat pieces of meat, sausages or fillets of fish. Cooking "au gratin."
13	Economy broil 	120 - 550°F (50 - 300°C) 430°F (220°C)	Only the center part of the grill heating element is heated. Energy-saving grilling for small amounts.
14	Baking stone function 	120 - 550°F (50 - 300°C) 480°F (250°C)	Baking stone only available as a special accessory Baking stone heated from below for crisp stone-baked pizza, bread or rolls.
15	Roaster function 	120 - 430°F (50 - 220°C) 360°F (180°C)	Roasting dish only available as a special accessory Heatable cast iron roasting pan for large quantities of meat, baked casseroles or holiday roasts.
16	Dough proofing 	85 - 120°F (30 - 50°C) 100°F (38°C)	Proofing: For yeast dough and sourdough. Dough will proof considerably more quickly than at room temperature. The optimal temperature setting for yeast dough is 100°F (38°C).
17	Defrosting 	100 - 140°F (40 - 60°C) 115°F (45°C)	Even, gentle defrosting. For vegetables, meat, fish and fruit.
18	Keeping warm 	85 - 250°F (30 - 120°C) 160°F (70°C)	Keeping food warm, pre-heating crockery.
S	Basic settings 		The basic settings of your appliance can be adjusted individually.
	Pyrolytic cleaning 	905°F (485°C)	Self-cleaning

## Accessories

Use only the accessories included or obtainable from after-sales service. It has been specially adapted to your appliance. Make sure you always insert accessories into the interior the right way round.

Your appliance comes with the following accessories:

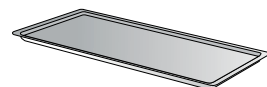

Baking tray, enameled



Wire grill tray



Deep baking tray with wire grill tray



Rotisserie spit

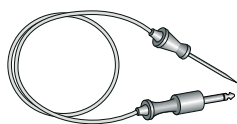

Plug-in core temperature probe

## Special accessories

You can order the following accessories from your specialist dealer:

BA 018 165	Pull-out system Fully extendable telescopic pull-out rack and pyrolysis-proof cast frame
BA 028 115	Baking tray, enameled, 3¼" (30 mm) deep
BA 038 165	Wire rack, chrome-plated, with feet
BA 058 115	Heating element for baking stone and roaster
BA 058 133	Baking stone Including heating element and pizza paddle (order heating element separately)
BA 090 100	Rotary selector, black, set with 2 pieces
BS 020 002	Pizza paddle, set of 2
GN 340 230	GN 2/3 cast aluminum roaster, height 6 1/2" (165 mm), non-stick (Order heating element and pull-out system separately)

Use the accessories only as indicated. The manufacturer assumes no liability for incorrect usage of the accessories.

Remove any accessories that are not required during operation from the cooking compartment. Bush for the additional heating element at the back of the cooking compartment: Always leave the cover in during normal operation without the additional heating element.

## Before using the appliance for the first time

In this chapter, you can find out what you must do before using your oven to prepare food for the first time. First read the section entitled → *"IMPORTANT SAFETY INSTRUCTIONS"* on page 4.

The appliance must be completely installed and connected.

After connecting the appliance to the power supply, the "Initial settings" menu will be displayed. Now you can now configure your new appliance for initial set-up.

### Notes

- The "Initial settings" menu will appear only after the appliance has been connected to a power supply and switched on for the first time, or if the appliance has not been connected to a power supply for a number of days.

Once the appliance has been connected to a power supply, the GAGGENAU logo will appear first for approximately 30 seconds. The "Initial settings" menu will then appear automatically.

- You can change the settings at any time in the basic settings. → *"Basic settings"* on page 36

## Setting the language

The default language appears in the display.

1. Select the desired display language with the rotary selector.
2. Confirm with ✓.

## Setting the time format

the two possible formats 24h and AM/PM appear in the display. The default format is 24h.

1. Set the required format with the rotary selector.
2. Confirm with ✓.

## Setting the time

The time appears in the display.

1. Set the required time with the rotary selector.
2. Confirm with ✓.

## Setting the date format

The three possible formats D.M.Y, D/M/Y and M/D/Y appear in the display. The D.M.Y is the default.

1. Set the required format with the rotary selector.
2. Confirm with ✓.

## Setting the date

The default date appears in the display. The day setting is already active.

1. Set the required day with the rotary selector.
2. Switch to the month setting with the > symbol.
3. Set the month with the rotary selector.
4. Switch to the year setting with the > symbol.
5. Set the year with the rotary selector.
6. Confirm with ✓.

## Setting the temperature unit

The two possible units °C and °F will appear on the display. The default unit is °C.

1. Use the rotary selector to select the unit you require.
2. Press ✓ to confirm.

## Completing initial set-up

"Initial set-up complete" will appear on the display.

Press ✓ to confirm.

The appliance will switch to standby mode and the standby display will appear. The appliance is now ready to use.

## Heating up the oven

Make sure that there is no leftover packaging in the cooking compartment.

To eliminate the new-appliance smell, heat up the oven with it empty and the door closed. One hour with hot air 🔥 at 200 °C is ideal for this.

## Cleaning accessories

Before using accessories for the first time, thoroughly clean them with hot soapy water and a soft dish cloth.

---

## Operating the appliance

---

### Oven interior

The oven interior has three insertion levels. These are counted from the bottom up.

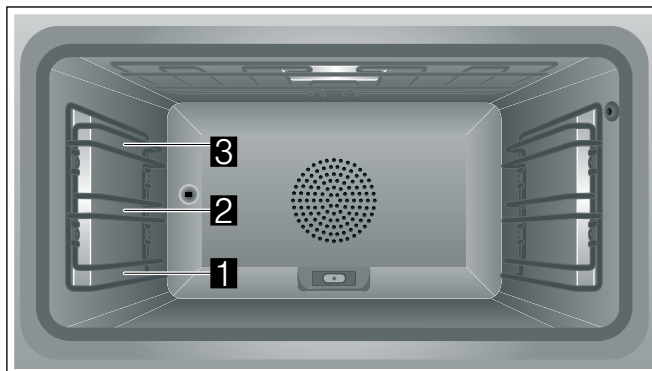

---

### ⚠ CAUTION

Do not place anything on the cooking compartment floor. Do not cover it with aluminum foil. A build-up of heat could damage the appliance or cause injury.

---

---

### ⚠ CAUTION

Do not slide any accessories between the shelf positions, or they may tip.

---

### Inserting the rack

The accessories feature a rack stop function. The rack stop function prevents tilting of accessories when pulling them out. You must insert accessories in the oven interior correctly so that tilt protection will work.

Inserting the rack



1. Tilt the rack to guide the rack stop in between the rails of the rack holders **A**. The rack stop has to face downwards.
2. Lower the rack and slide it into the oven, so that the rack stop can engage **B**. Make sure the rack's safety rod is at the rear and top **C**.



## Quick heat

With the "Quick heat" function, your appliance reaches the desired temperature particularly quickly in the top heat, bottom heat, and top/bottom heat types of heating.

To ensure an even cooking result, do not place your food in the cooking compartment until "Quick heat" is complete and the  heat-up symbol goes out.

**Note:** The "Quick heat" function is preset in the factory settings. In the basic settings, you can select  Quick heat or  Heat-up. → "Basic settings" on page 36

## Safety shut-off

For your protection, the appliance has a safety shut-off feature. Every heating operation is switched off after 12 hours if the appliance is not operated during this time. A message appears in the display.

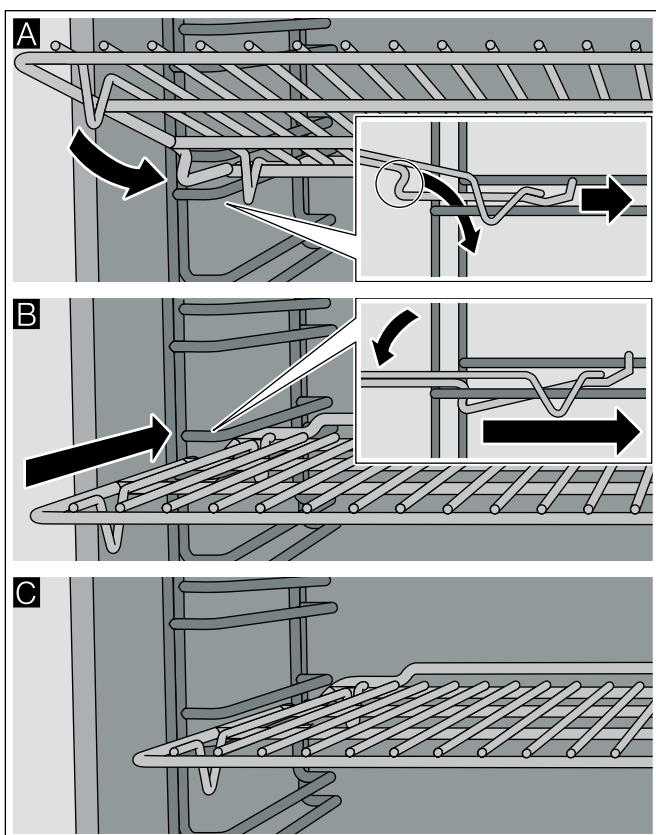

Exception:  
programming with the long-term timer.

Turn the program selection to **0**, after which you can operate the appliance in the manner to which you are accustomed.



## Turning on

1. Set the required heating mode using the function selector. The chosen heating mode and the default temperature are displayed.
2. If you want to change the default temperature:  
set the required temperature with the rotary selector.

The preheating symbol  appears on the display. The bar continuously shows the preheating status. When the set temperature is reached, a signal sounds and the preheating symbol  goes off.

**Note:** The oven interior lighting stays switched off at a temperature setting below 160° F (70° C).

### Switching off:

Turn the function selector to **0**.

## Timer functions

In the timer menu, set:

- ⌚ Timer
- ⌚ Stopwatch
- 🕒 Cooking time (not in the idle state)
- 🕒 Cooking time end (not in the idle state)

### Launching the timer menu

You can launch the timer menu from any mode. Only from the factory settings, program selection is set to **S**, the time menu is not available.

Touch the ⌚ symbol.

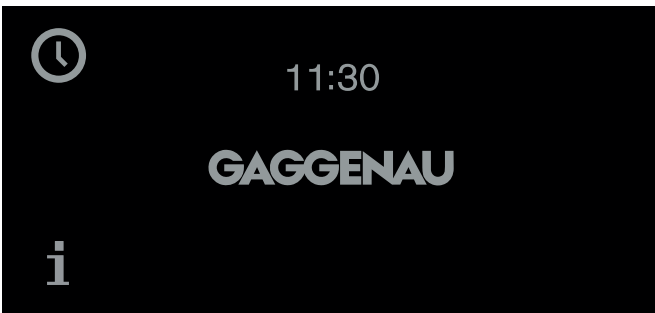

The timer menu appears.

### Timer

The timer runs independently of the other appliance functions. You can enter a maximum of 90 minutes.

#### Setting the timer

1. Call up timer menu.  
The "Timer" ⌚ function is displayed.
2. Turn the rotary selector to set the required cooking time.

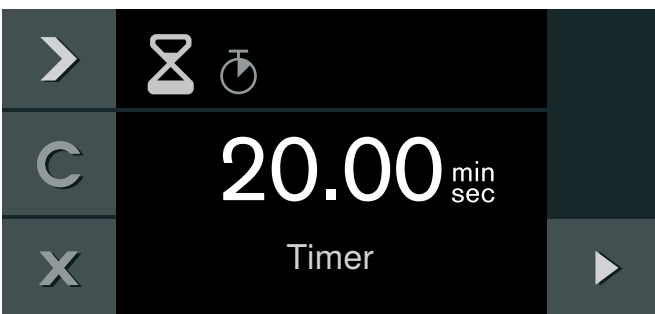

3. Start with ▶.

The timer menu closes and the time begins to count down. The ⌚ symbol and the countdown appear in the display.

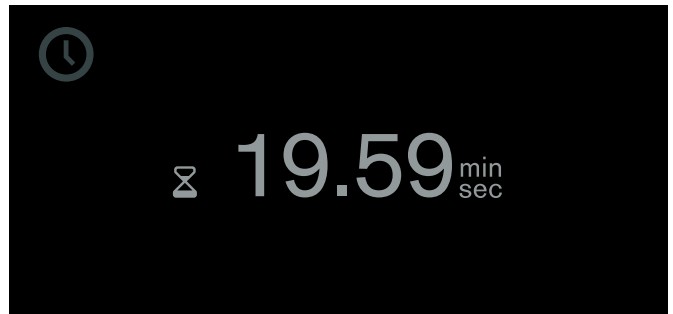

A signal sounds once the time has elapsed. Touch the ✓ symbol to silence.

You can exit the timer menu at any time by pressing the X symbol. This erases the settings.

#### To stop the timer:

Call up timer menu. Touch ▶ to select the "Timer" ⌚ function and touch the || symbol. To allow the timer to continue counting down, touch the symbol ▶.

#### Switching off the timer early:

Call up timer menu. Touch ▶ to select the "Timer" ⌚ function and touch the C symbol.

### Stopwatch

The stopwatch runs independently of the other appliance functions.

The stopwatch counts up from 0 seconds to 90 minutes.

It has a pause function. Therefore, you can stop the timer in between times.

#### Starting the stopwatch

1. Launching the timer menu.
2. With ▶, select the "Stopwatch" function ⌚.

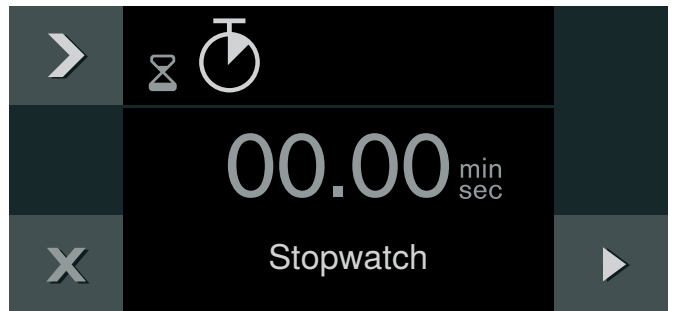

### 3. Start it with ▶.

The timer menu is closed and the time runs. The ⌚ symbol and the elapsing timer are shown in the display.

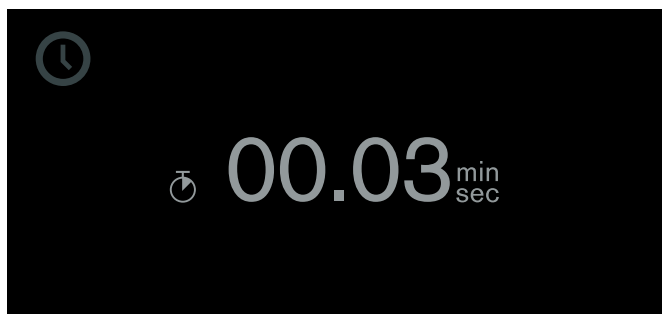

### Stopping and restarting the stopwatch

1. Launch the timer menu.
2. With >, select the "Stopwatch" function ⌚.
3. Touch the || symbol.

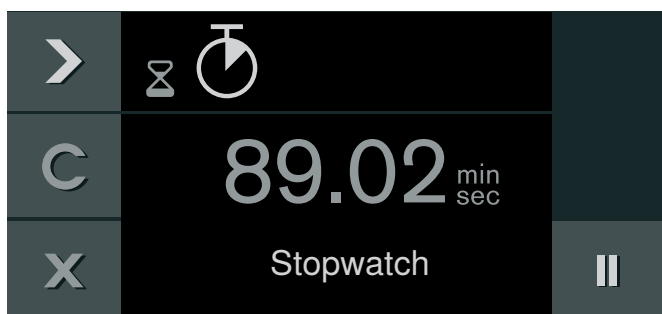

The time stops. The symbol changes to Start ▶ again.

### 4. Start with ▶.

The time continues to run. Once 90 minutes have been reached, the display pulsates and a signal sounds. It goes off when you touch the ✓. The ⌚ symbol disappears from the display. The operation has ended.

#### Switching off the stopwatch:

Launch the timer menu. With >, select the "Stopwatch" function ⌚ and touch the C symbol.

## Cooking time

If you set a cooking time for your meal, the appliance switches off heating automatically after this time has elapsed.

You can set a cooking time from 1 minute to 23:59 hours.

### Set cooking time

You have set the heat mode and the temperature and placed your food in the oven.

1. Touch the ⌚ symbol.
2. Using the > function, select ⌚ "cooking time".

3. Set the preferred cooking time with the rotary selector.



### 4. Start with ▶.

The appliance will start. The timer menu will close. Temperature, mode, remaining time, and end of cooking time will appear on the screen.

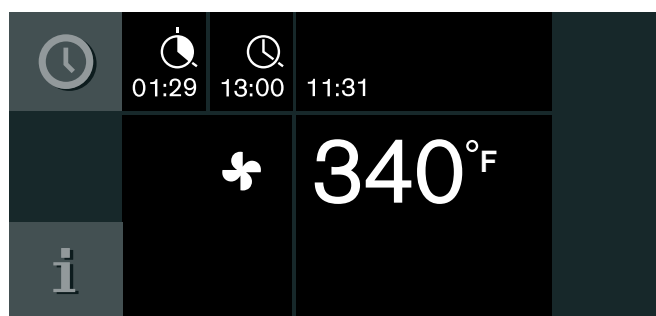

One minute before the end of cooking time, the remaining time will be magnified on the screen.

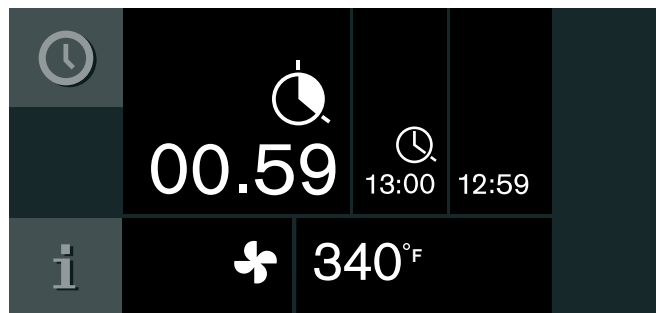

The appliance will turn off after the cooking time has ended. The ⌚ symbol will pulse and a signal will sound. It will stop when you touch the ✓ symbol, open the appliance door, or set the program selection to 0.

#### Change cooking time:

Call up timer menu. Using the > function, select ⌚ "cooking time". Change the cooking time using the rotary selector. Start with ▶.

#### Delete cooking time:

Call up timer menu. Using the > function, select ⌚ "cooking time". Delete cooking time with C. Return to normal use with X.

#### Cancel complete process:

Set program selection to 0.

**Note:** You can also change temperature and heat mode during the cooking time.

## End of cooking time

You can defer the end of the cooking time until later.

Example: it is 2 pm. The meal takes 40 minutes to cook. It should be ready by 3.30 pm.

Enter the cooking time and shift the end of the cooking time to 3.30 pm. The electronic circuitry calculates the starting time. The appliance starts automatically at 2:50 pm and switches off at 3.30 pm.

Note that easily perishable foodstuffs must not be left in the oven for too long.

### Delay end of cooking time

You have set the heat mode, temperature, and cooking time.

1. Touch the ⌚ symbol.
2. Using the ➤, select ⌚ "end of cooking time".



3. Using the rotary selector, set the preferred end of cooking time.
4. Start with ▶.

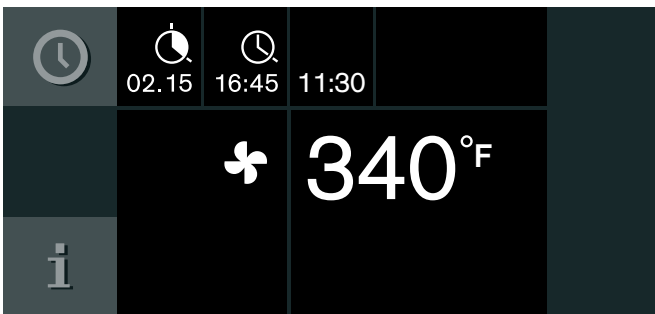

The appliance will go on standby. The screen will display the mode, temperature, cooking time, and end of cooking time. The appliance will start at the calculated time and will turn off automatically once the cooking time has run out.

**Note:** If the ⌚ symbol is blinking: a cooking time has not been set. Always set the cooking time first.

The appliance will turn off after the cooking time has ended. The ⌚ symbol will pulse and a signal will sound. It will stop when you touch the ✓ symbol, open the appliance door, or set the program selection to 0.

### Change end of cooking time:

Call up timer menu. Using the ➤, select ⌚ "end of cooking time". Using the rotary selector, set the preferred end of cooking time. Start with ▶.

### Cancel complete process:

Set program selection to 0.

## Sabbath mode and Yom Tov mode

### Sabbath mode

With this function, the appliance maintains a temperature between 120 and 450°F (50 and 230°C) with the convection heating function.

You can keep dishes warm for up to 74 hours without having to switch on or off.



Note that easily perishable foodstuffs must not be left in the oven for too long.

**Note:** You must activate the Sabbath mode in the factory setting in order to operate the mode. → "Basic settings" on page 36

#### Follow these steps:

1. Set the program selector to **S**.
2. Select "Factory setting" with the rotary selector.
3. Confirm by touching the ✓ symbol.
4. Rotate the selector to Sabbath mode .
5. Confirm by touching the ✓ symbol.
6. Rotate the selector to "activate".
7. Confirm by touching the ✓ symbol.
8. Turn the oven off.

#### Setting the Sabbath mode



1. Set the program selector to . To set the Sabbath mode for both ovens, set both program selectors to .
2. Touch the  symbol.

The suggested value of 24h at 185° F (85° C) appears in the display. Start with ▶

- or -

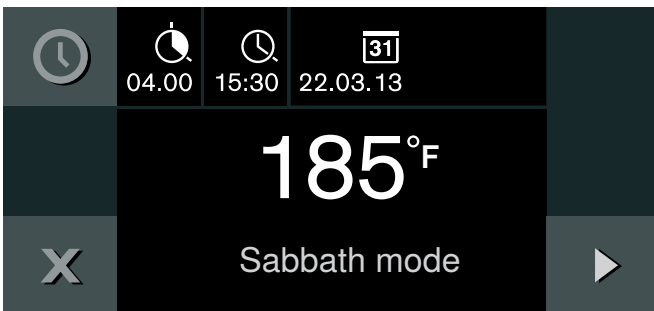
Change the cooking time and the temperature.



3. Changing the cooking time : Touch the  symbol. Set the preferred cooking time with the rotary selector. You can set up to 74 hours. Confirm by touching the ✓ symbol. Then changing the temperature becomes an option.

4. Changing the temperature:  
Set the required temperature with the rotary selector.
5. Start with ▶.

The appliance starts.  and the temperature appear in the display. The Sabbath screen will appear as shown.



The oven and display lighting is off. The control panel is blocked and no tone can be heard when you touch it.

The appliance no longer heats after expiry of the time. The display is blank. Set the program selector to **0**.

#### Switching off:

To cancel the operation, set the program selector to **0**.

### Yom Tov mode

With this function, the appliance is programmed to perform in three stages.

Stage 1 and 2 can be programmed for a maximum total duration of 74 hours. The duration of Step 3 is 1 hour and cannot be modified.



**Stage 1:** maintains a warm temperature of 122° F (50° C) in the convection heating function. The interior oven lights remain off through this stage.

**Stage 2:** the appliance raises to a desired temperature setting and maintains a temperature between 120 and 450° F (50 -230° C). For warming and cooking foods in the convection heating function. The desired time can be adjusted for this stage. The interior oven lights will be on during this time.

**Stage 3:** maintains a warm temperature of 122° F (50° C) in the convection heating function for 1 hour after stage 2 has ended. The interior oven lights will be on during this time.





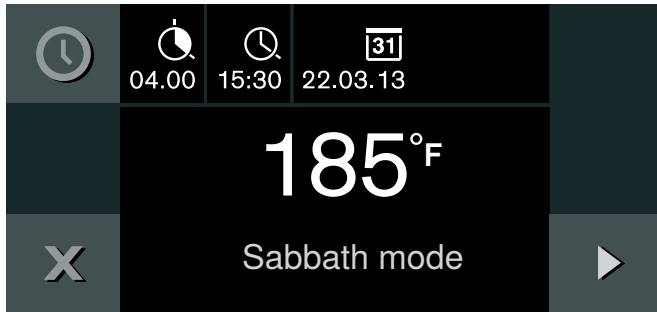

Note that easily perishable foodstuffs must not be left in the oven for too long.

### Setting the Yom Tov mode

1. Set the program selector to . To set the Yom Tov mode for both ovens, set both program selectors to .
2. Touch the  symbol.  
The suggested value of 24h at 185° F (85° C) appears in the display.



To set Stage 2 cooking time with rotary selector:

1. Touch the  symbol to adjust the duration of Stage 2 cooking time .
2. Set the desired Stage 2 cooking time with the rotary selector.
3. Touch the  symbol to adjust the end of Stage 2 cooking time .
4. Select the end time with the rotary selector.
5. Change the date if needed by touching the  symbol to .
6. Rotate the selector to the desired date.
7. Confirm settings by touching the  symbol.

To set Stage 2 temperature:

1. Rotate selector to desired Stage 2 temperature.
2. Start with .

The temperatures of Stage 1 and Stage 2 appear in the display. The remaining time to the beginning of Stage 2 is counted down in the display. The Yom Tov screen will appear as shown.

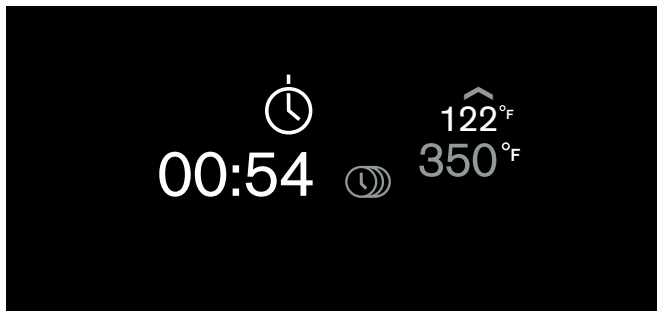

The program will begin with the pre-set warm temperature without light, then advance to the programmed temperature with light until the end of the set date and time, and then maintain the pre-set warm temperature for 60 minutes.

The appliance no longer heats after expiry of the time. The display is blank. Set the program selector to **0**.

#### Switching off:

To cancel the operation, set the program selector to **0**.

## Automatic programs

You can prepare a wide range of food using the automatic programs. The appliance will choose the optimal setting for you.

To achieve good results, the cooking compartment must not be too hot for the type of food you have selected. If it is, a message will appear on the display. Allow the appliance to cool and then try again.

### Information on the settings

- The cooking result depends on the quality of the food and the size and type of cookware. For an optimal cooking result, only use food that is in good condition and meat that is chilled to refrigerator temperature. For frozen food, use food straight out of the freezer only.
- The automatic program suggests a temperature, type of heating and cooking time.
- For some dishes, you will be required to enter the weight. It is not possible to set weights outside of the intended weight range.
- For some dishes, you will be asked to enter desired level of browning, the thickness of the food and/or the cooking level of the meat or vegetables.
- For some dishes, the cooking compartment is preheated empty. Place the food in the cooking compartment once the preheating is complete and a message appears in the display.
- Your preferred settings will be shown next time as a suggestion.

#### Core temperature probe

For some recipes, you will need the core temperature probe. Use the core temperature probe for these recipes.  
→ "Core temperature probe" on page 26

## Selecting a dish

The following categories are available. One or more dishes are listed beside each category.





### Categories:

- Vegetables
- Oven dishes
- Fish
- Meat and poultry
- Bread, pizza and cake
- Drying
- Dough

## Applying settings for dishes

You are guided through the entire setting process. Follow the instructions in the display.

Use the rotary selector to scroll through the individual levels.

1. Set the function selector to .
2. Touch the  symbol. Press  to confirm.
3. Use the rotary selector to select the category and press  to confirm.
4. Use the rotary selector to select the required dish and press  to confirm.

The possible settings appear in the display. For many dishes, you can change the settings to suit your needs.

For some dishes, you must set the weight.

**Tip:** By pressing the  symbol, you can receive information about accessories and preparation methods.

5. Press  to confirm the required settings. Follow the directions on the display.

The cooking time will count down on the display.

Once the cooking time has elapsed, an audible signal sounds. The appliance stops heating.

---

## WARNING

### Risk of scalding!

Hot steam can escape when you open the appliance door. Open the appliance door with caution. Keep children away.



---

Opening the appliance door affects the cooking result. Open the appliance door only briefly. The automatic program is interrupted and continues to run after closing the appliance door.

## Adding extra cooking time

After the cooking time has ended, you can leave some dishes to continue cooking if you are not satisfied with the cooking result.

A query appears on the display, which asks if you want to continue cooking.

1. Press  to confirm.
2. Select a single or double cooking time, depending on requirements.
3. Press  to start.
4. If the "Continue cooking" function has ended, turn the function selector to **0**.





## Changing and canceling

After starting the appliance, the settings can no longer be changed.

If you want to cancel the operation, turn the function selector to **0**.

## Calling up the last automatic programs used

The last five dishes with the selected settings are saved. You have the option of saving these dishes with the selected settings as individual recipes. You can no longer change the settings of an individual recipe if you have saved it using the "Last automatic programs" function → *"Personal recipes" on page 24*





1. Set the function selector to .  is displayed.
2. Touch the  symbol.
3. Use the rotary selector to select "Last automatic programs" and press  to confirm.
4. Use the rotary selector to select the required dish and press  to confirm.
5. Enter a name for the dish and save. → *"Entering a name" on page 25*

## Personal recipes

You can save up to 50 individual recipes. You can record a recipe. You can assign these recipes a name so that you can fall back on them quickly and conveniently if you need them.

### Recording a recipe

It is possible to set up to 5 phases consecutively while recording at the same time.

1. Set the function selector to .
2. Touch the  symbol.
3. Use the rotary selector to select "Individual recipes" and press  to confirm.
4. Use the rotary selector to select a free memory location.
5. Touch the  symbol.

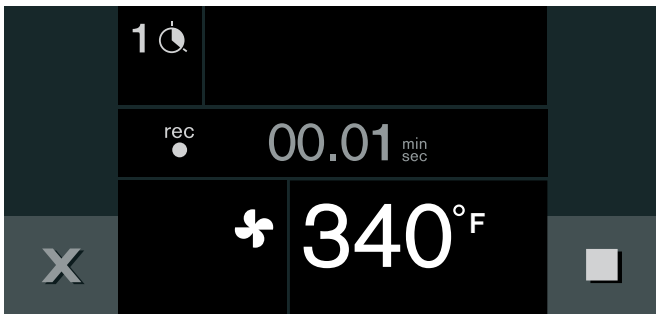



6. Set the desired temperature with the rotary selector.
7. The cooking time is recorded.
8. Recording another phase:  
Set the program selection to the required heating function. Set the required temperature with the rotary selector. A new phase begins.
9. Once the appliance has achieved the desired cooking result, touch the  symbol to end the recipe.
10. Enter the name under "ABC". → "Entering a name" on page 25

#### Notes





- Recording a phase does not begin until the appliance has reached the set temperature.
- Every phase must last at least one minute.
- During the first minute you can change the heating function or the temperature.

#### Enter the core temperature for a phase:

Insert the core temperature probe in the socket in the oven interior. Set the heating function and temperature. Touch the  symbol. With the rotary selector, enter the required temperature and confirm it with .





### Programming a recipe

You have the option of programming and saving up to five phases of preparation.

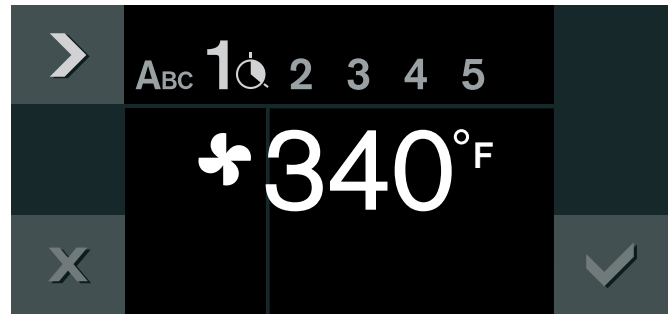

1. Set the function selector to .
2. Touch the  symbol.
3. Use the rotary selector to select "Individual recipes" and press  to confirm.
4. Choose a free storage location with the rotary selector.
5. Touch the  symbol.
6. Enter the name under "ABC". → "Entering a name" on page 25
7. Choose the first phase with the  symbol.

The heating function and temperature set at the start are displayed. You can change the heating function and temperature with the rotary selectors.



8. Choose the time setting with the  symbol.
9. Set the required cooking time with the rotary selector.
10. Choose the next phase with the  symbol.  
- or -  
Preparation is complete, end input.
11. Save with .
- or -  
Cancel with  and quit the menu.

#### Enter the core temperature for a phase:

Choose the next phase with the  symbol. Set the heating function and temperature. Touch the  symbol. With the rotary selector, enter the required temperature and confirm it with .

**Note:** For phases for which a core temperature has been programmed you cannot set a cook time.



## Entering a name

1. Enter the recipe's name under "ABC".

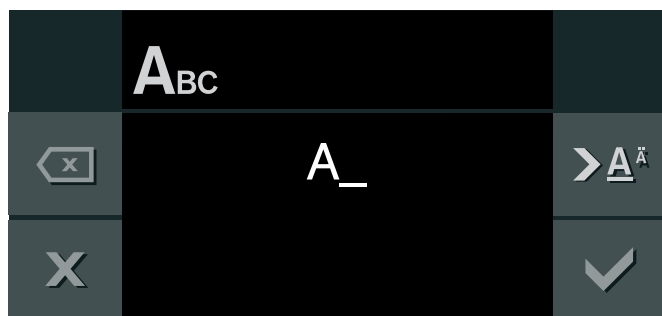

Rotary selector	Selecting letters A new word always begins with an upper case letter.
➤ <sup>A</sup>	Press briefly: cursor to the right Press long: switch to diacritics and special characters Press twice: insert line space
➤ <sup>Ä</sup>	Press briefly: cursor to the right Press long: switch to normal characters Press twice: insert line space
⌫	Clear letters

2. Save with ✓.

- or -

Cancel with **X** and quit the menu..

**Note:** For entering a name, Latin characters, certain special characters and numbers are available.

## Starting a recipe

1. Set the function selector to ☼.
2. Touch the 🍷 symbol.
3. Use the rotary selector to select "Individual recipes" and press ✓ to confirm.
4. Use the rotary selector to select the desired recipe.
5. Press ▶ to start.

The operation begins. The cooking time starts counting down.

The settings for each phase are shown in the display.

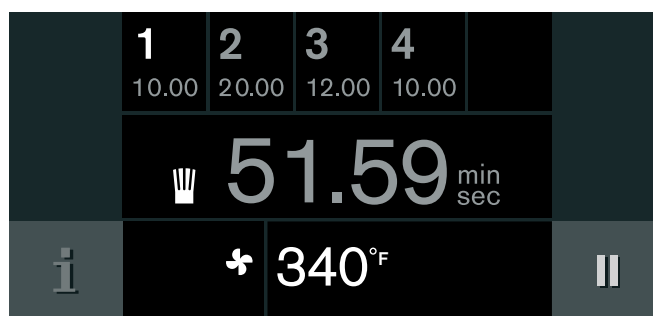

### Notes

- The cooking time does not start counting down until the appliance has reached the set temperature.
- You can use the rotary selector to change the temperature while the recipe is in progress. This does not change the saved recipe.

## Change recipe

You can change the settings of a recorded or programmed recipe.

1. Set the function selector to ☼.
2. Touch the 🍷 symbol.
3. Use the rotary selector to select "Individual recipes" and press ✓ to confirm.
4. Use the rotary selector to select the desired recipe.
5. Touch the \\_ symbol.
6. Use the ➤ symbol to select the desired phase.

The programmed heating type, temperature, and cooking time are displayed. You can change the settings with the rotary selector or the function selector.

7. Save with ✓.

- or -

Cancel with **X** and exit the menu.

## Deleting a recipe

1. Set the function selector to ☼.
2. Touch the 🍷 symbol.
3. Use the rotary selector to select "Individual recipes" and press ✓ to confirm.
4. Use the rotary selector to select the desired recipe.
5. Delete the recipe with **C**.
6. Press ✓ to confirm.

---

## Core temperature probe

---

The core temperature probe makes it possible to cook with exact precision. It measures the temperature inside the food being cooked. When the required core temperature has been reached, the probe switches off automatically, ensuring that all food is cooked perfectly.

---

### **⚠ WARNING**

#### **Risk of electric shock!**

Use of a wrong core temperature probe can damage the insulation. Use only the core temperature probe intended for this appliance.

---

---

### **⚠ WARNING**

#### **Risk of burns!**

The oven interior and the core temperature probe become very hot. Use oven mitts to plug and unplug the core temperature probe.

---

---

### **⚠ CAUTION**

#### **Damage to the core temperature probe:**

Do not use the core temperature probe with the heating modes "Broil" or "Economy Broil". Before using the heating modes "Broil" or "Economy Broil", remove the core temperature probe from the oven cavity. It is possible to use the heating mode "Broil + Circulated Air" at temperatures up to 480° F (250 °C).

---

---

### **⚠ CAUTION**

#### **Damage to the core temperature probe:**

The core temperature probe may be damaged at temperatures above 480° F (250 °C). When using the core temperature probe, never set the temperature above 480° F (250 °C).

---

## Inserting the core temperature probe into the food

Insert the core temperature probe into the food before you place the food in the oven cavity.

The core temperature probe has three measuring points. Insert the core temperature probe as far as possible. The core temperature probe must not be inserted in the fat or be touching the ovenware or bones.

**Meat:** Insert the core temperature probe at an angle from above as far as it will go into the meat.

For more than one piece of meat, insert the core temperature probe into the middle of the thickest piece.

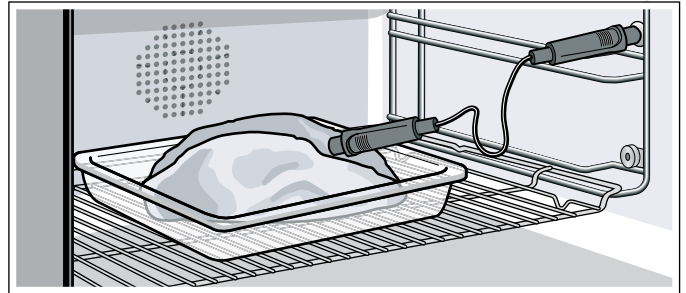

**Poultry:** Insert the core temperature probe as far as it will go into the thickest point in the breast. Depending on its structure, insert the core temperature probe into the poultry crossways or lengthways. With poultry, make sure that the tip of the core temperature probe does not protrude into the cavity in the middle of the bird.

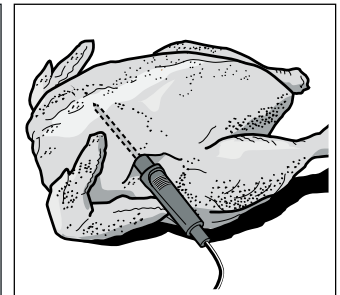
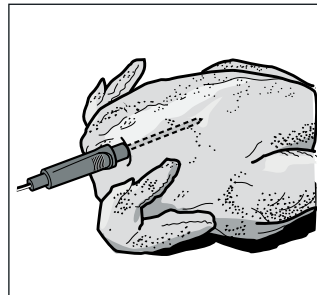

**Fish:** Insert the core temperature probe behind the head as far as it will go towards the spine. Place the whole fish onto the wire rack and prop it up in the swimming position using half a potato.

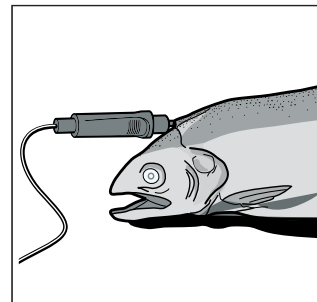

**Turning the food:** If you want to turn the food, do not remove the core temperature probe. Once you have turned the food, check that the core temperature probe is correctly positioned in the food.

If you remove the core temperature probe during operation of the appliance, all settings are reset and you have to apply them again.

## Setting the core temperature

### CAUTION



#### Damage to the core temperature probe:

The core temperature probe may be damaged if the distance between the grill heating element and the core temperature probe is too small. Make sure that the distance between the grill heating element and the core temperature probe or the cable of the core temperature probe is a few centimeters. The meat may expand during the cooking process.

### CAUTION

#### Damage to the core temperature probe:

Do not trap the cable of the core temperature probe in the appliance door.

1. Insert the food to cook in the oven cavity with a core temperature probe inserted. Insert the core temperature probe into the socket in the oven cavity and close the appliance door.
2. Turn the function selector to the desired heating type.
3. Use the rotary selector to set the oven cavity temperature.
4. Touch the  symbol. Use the rotary selector to change the set core temperature for the food and confirm with .  
The core temperature set must be higher than the current core temperature.
5. The appliance heats with the set heating type.  
The display indicates the current temperature, and below that the set core temperature.

You can change the set core temperature at any time.

Once the set core temperature is reached, a signal sounds. Cooking is automatically ended. Confirm with  and turn the function selector to **0**.

## Estimated cooking time

After preheating, if the appliance has a temperature setting above 212° F (100 °C), when the core temperature probe is inserted, the display shows an estimated cooking time approx. 5–20 minutes into the cooking time.

The estimated cooking time is continually updated. The longer the cooking process lasts, the more precise the estimated cooking time becomes. Do not open the appliance door; this distorts the estimated cooking time.

The estimated cooking time is displayed in normal operation and in the automatic program.



The current core temperature is shown in the display when you touch the **i** symbol.

The estimated cooking time display can be deactivated in the basic settings so that the current core temperature is shown instead. → "Basic settings" on page 36

## Notes

- At the beginning of the cooking time, "<59° F" ("<15° C") is displayed for 3-4 minutes for the current core temperature.
- The measurable range is 59 to 210° F (15° C to 99° C). Outside the measurable range, <59° F or --° F ("<15° C" or "--° C") is displayed as the current core temperature.
- If you leave the food in the cooking compartment for some time after cooking, the core temperature will continue to rise somewhat due to the residual heat in the cooking compartment.
- If you set programs with the core temperature probe and the cooking timer at the same time, the appliance switches off whichever program reaches the entered value first.

## Changing the set core temperature

Touch the  symbol. Use the rotary selector to change the set core temperature for the food and confirm with .

## Deleting the set core temperature

Touch the  symbol. Delete the set core temperature with **C**. The appliance continues heating in normal cooking mode.

## Core temperature guidelines

Use chilled food only, not frozen food. The details given in the table are guidelines. Results depend on the quality and composition of the food.

For hygiene reasons, critical foodstuffs such as fish and game should reach a core temperature of 143 - 158° F (62 - 70 °C); for poultry and minced meat this should be as high as 176 - 185° F (80 - 85 °C).

Food	Core temperature guideline
<b>Beef</b>	
Sirloin, tenderloin, entrecôte	
very rare	113 - 117°F (45 - 47 °C)
rare	122 - 126°F (50 - 52 °C)
medium	137 - 140°F (58 - 60 °C)
well-done	158 - 167°F (70 - 75 °C)
Roast beef	176 - 185°F (80 - 85 °C)
<b>Pork</b>	
Pork roast	162 - 176°F (72 - 80 °C)
Pork loin	
medium	149 - 158°F (65 - 70 °C)
well-done	167°F (75 °C)
Meat loaf	185°F (85 °C)
Fillet of pork	149 - 158°F (65 - 70 °C)
<b>Veal</b>	
Veal roast, well-done	167 - 176°F (75 - 80 °C)
Breast of veal, stuffed	167 - 176°F (75 - 80 °C)
Saddle of veal	
medium	137 - 140°F (58 - 60 °C)
well-done	149 - 158°F (65 - 70 °C)
Fillet of veal	
rare	122 - 126°F (50 - 52 °C)
medium	137 - 140°F (58 - 60 °C)
well-done	158 - 167°F (70 - 75 °C)

Food	Core temperature guideline
<b>Game</b>	
Saddle of venison	140 - 157°F (60 - 70 °C)
Leg of venison	158 - 167°F (70 - 75 °C)
Venison loin steaks	149 - 158°F (65 - 70 °C)
Saddle of hare or rabbit	149 - 158°F (65 - 70 °C)
<b>Poultry</b>	
Chicken	195°F (90 °C)
Guinea fowl	175 - 185°F (80 - 85 °C)
Goose, turkey, duck	185 - 195°F (85 - 90 °C)
Duck breast	
medium	131 - 140°F (55 - 60 °C)
well-done	158 - 176°F (70 - 80 °C)
Ostrich steak	140 - 149°F (60 - 65 °C)
<b>Lamb</b>	
Leg of lamb	
medium	140 - 149°F (60 - 65 °C)
well-done	158 - 176°F (70 - 80 °C)
Saddle of lamb	
medium	131 - 140°F (55 - 60 °C)
well-done	149 - 167°F (65 - 75 °C)
<b>Mutton</b>	
Leg of mutton	
medium	158 - 167°F (70 - 75 °C)
well-done	176 - 185°F (80 - 85 °C)
Saddle of mutton	
medium	158 - 167°F (70 - 75 °C)
well-done	176 °F (80 °C)
<b>Fish</b>	
Fillet	144 - 149°F (62 - 65 °C)
Whole	149°F (65 °C)
Terrine	144 - 149°F (62 - 65 °C)

Food	Core temperature guideline
<b>Other provisions</b>	
Bread	205°F (96 °C)
Paté	162 - 167°F (72 - 75 °C)
Terrine	140 - 158°F (60 - 70 °C)
Foie gras	113°F (45 °C)
Reheating food	167°F (75°C)

## Rotisserie spit

Using the rotisserie spit, you can prepare large roasts such as rolled roast and poultry particularly well. The meat becomes crispy and brown all round.

You can use the rotisserie spit in all modes of operation. You achieve the best results with the "Broil" or "Top heat" heating functions.

### **!** CAUTION

Do not use the temperature probe in combination with the rotisserie spit.

## Preparation

1. Insert both supportin frames in the sockets on the grill tray. The drive is on the left.

**Note:** Make sure the supporting frames are in the correct position.

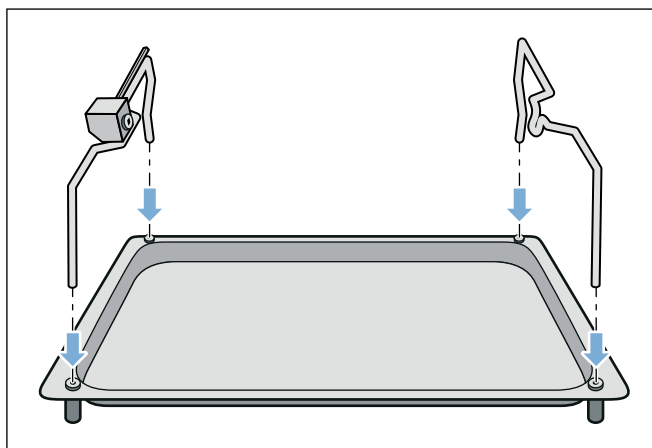

2. Plug the right retaining clip onto the rotisserie spit and screw it in firmly.

- Place the food you want to cook on the rotisserie spit's center. Secure protruding parts (e.g. wings) to make sure they do not touch the grill heating element. Plug the left retaining clip onto the rotisserie spit and screw it in firmly.

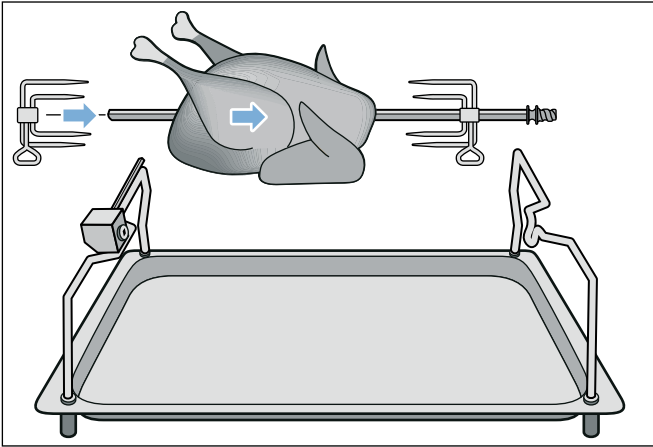

- If you want to cook two small chickens (max. 1.5 kg/ chicken) at the same time, use retaining clips either side of each chicken and screw them in to secure the chickens in place.

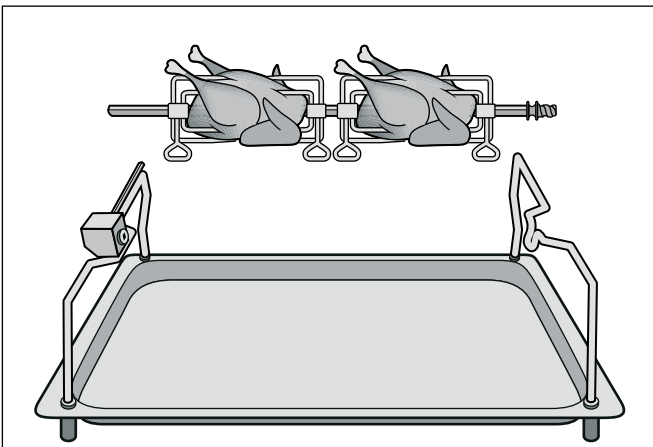

- Place the rotisserie spit on the supports. Latch the square shaft into the drive section.

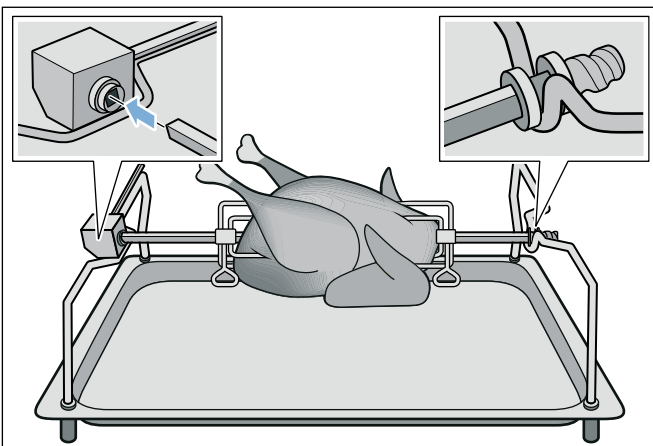

- Insert the rotisserie spit in the lowest insertion level in the oven.

**Note:** The drive spindle must engage in the opening on the oven's rear wall. If necessary, turn the rotary spit slightly.

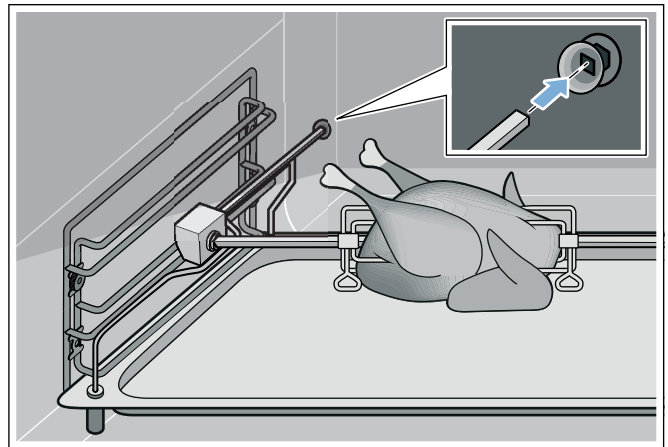

## Switching on the rotisserie spit

- Set the required temperature and heating function.
- Touch the  symbol. The rotisserie spit is switched on.

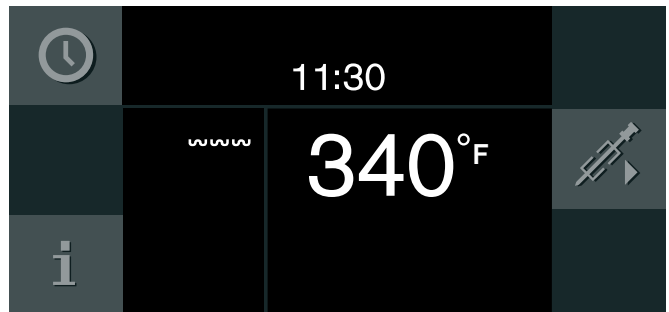

## Switching off the rotisserie spit

1. Touch the  symbol. The rotisserie spit's drive stops.
2. Switch off the oven with the program selection.
3. Take out the grill tray with the rotisserie spit and place them on a stable, heat-resistant surface.

### **WARNING**

#### **Risk of burns!**

Use a glove to remove them.

4. Screw on the handle at the side to remove the rotisserie spit.

#### **Notes**

- Use the rotisserie spit at oven temperatures up to 480° F (250° C) only.
- Do not clean the drive part of the rotisserie spit in a dishwasher.

## Roasting function

Only with heating mode "Roaster function":  
You will need the roaster, pull-out system and heating element (optional accessories).

In the searing stage, the oven heats at full power for approx. 3 minutes. This way, you can sear steaks, for example.

Touch the  symbol. The searing stage starts up. You can also set the searing feature several times one after another.

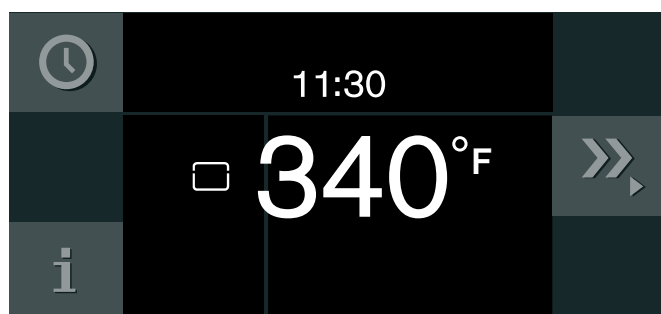

To end the searing stage early, touch .

## Childproof lock

The appliance has a panel lock to make sure children cannot operate it inadvertently.

#### **Notes**

- You must set the child lock in the factory setting to "Available" → "Basic settings" on page 36
- If there is a power cut while the child lock is activated, it may be deactivated when the power returns.

## Activating the child lock

#### **Requirement:**

Program selector is set to 0.

Touch the  symbol for at least 6 seconds.

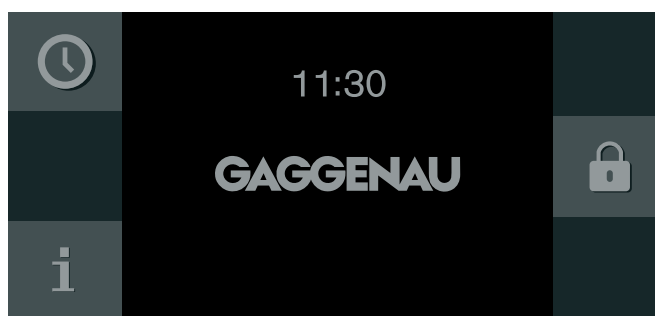

The child lock is activated. The standby screen appears. The  appears at the top of the display.

## Deactivating the child lock

#### **Requirement:**

Program selector is set to 0.

Touch the  symbol for at least 6 seconds.

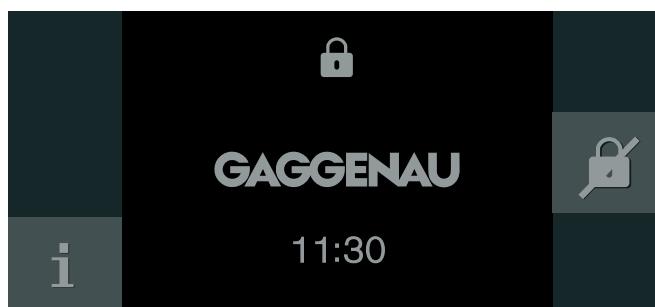

The child lock is deactivated. You can switch on the appliance in the usual manner.

## Home Connect

This appliance can be networked and also controlled remotely using a mobile device. The Home Connect app offers extra functions that complement the networked appliance perfectly. If the appliance is not connected to your home network, it can be operated as usual via the display.

The availability of the Home Connect function depends on the availability of Home Connect services in your country. Home Connect services are not available in every country. You can find more information on this at [www.home-connect.com](http://www.home-connect.com).

### Notes

- Ensure that you follow the safety instructions in this instruction manual and that you comply with these even when you are away from home and are operating the appliance via the Home Connect app. You must also follow the instructions in the Home Connect app.
- Operating the appliance directly from the appliance always takes priority. It is not possible to operate the appliance using the Home Connect app during this time.
- Refer to the Home Connect documents supplied for more information.

## Setting Up

To configure settings via Home Connect, you will need to have installed the Home Connect app on a mobile device.

Your appliance will also need to be connected to your home network and to the Home Connect app. You can choose between the following connection types:

- Connection via LAN cable: The appliance is connected to the home network automatically following confirmation on the appliance.
- Connection via Wi-Fi: Establish the connection to your home network and then the connection to the Home Connect app.

**Note:** The app will guide you through the entire registration process. In case of doubt, follow the instructions in the app.

### Installing the app

Install the Home Connect app on your mobile device (e.g. tablet PC or smartphone).

1. On your mobile device, go to the App Store (Apple devices) or the Google Play Store (Android devices).
2. Enter the search term "Home Connect".

3. Select the Home Connect app and install it on your mobile device.
4. Launch the app and set up Home Connect access.
 

The app will guide you through the registration process.

### Connecting the appliance to your home network (LAN)



The appliance must be connected to your home network using a LAN cable.



The network connection will be established automatically when the appliance is connected to the mains electricity supply for the first time and put into operation.

### Connecting the appliance to your home network (Wi-Fi with WPS)

Requirements:



- Your router must have a WPS button. You will find information about this in the manual for your router.
- You need to be able to access your router.



1. In the basic settings, select  "Home Connect".
2. Touch the .
3. Turn the rotary selector to "Wi-Fi".
4. Confirm by touching the  symbol.
 

A message about the WPS function will appear.
5. Touch the  symbol to continue.
6. Turn the rotary selector to "Automatic (WPS)".
7. Touch the  symbol to start the connection process.
8. Press the WPS button on the router within the next 2 minutes.

If the display shows "Network connection successful", the connection process is complete. Follow the instructions in the app.

### Connecting the appliance to your home network (Wi-Fi without WPS)

1. In the basic settings, select  "Home Connect".
2. Touch the .
3. Turn the rotary selector to "Wi-Fi".
4. Confirm by touching the  symbol.
 

A message about the WPS function will appear.
5. Touch the  symbol to continue.
6. Turn the rotary selector to "Manual".
7. Touch the  symbol to start the connection process.
 

The appliance will set up its own "Home Connect" Wi-Fi network to which the tablet or smartphone must be connected.
8. Follow the instructions in the app.





If the display shows "Network connection successful", the connection process is complete. Follow the instructions in the app.

### Connecting the appliance to the app

Connect your appliance to the app when setting up Home Connect or connect your appliance to an additional Home Connect account. The Home Connect app can be installed on any number of mobile devices, which can then be connected to the appliance.





Requirements:

- The appliance is connected to your home network.
  - The Home Connect app has been installed on the mobile device.
1. To connect an additional account, select "Home Connect" in the basic settings.
  2. Use the rotary selector to select "Connect to app".
  3. Touch the  symbol and start the connection process with .
  4. Follow the instructions in the app.

If the display shows "Connection to app successful", the connection process is complete.

## Home Connect settings

Home Connect can be adapted to your specific needs at any time.

	Basic setting	Possible settings	Explanation
	Connection type	LAN/Wi-Fi	You can switch between connection types (LAN cable and Wi-Fi).  Follow the instructions for setting up the relevant connection type. → "Setting Up" on page 32
	Connecting	Connect/disconnect	Switch the network connection on or off as required (e.g. for holiday).  Network information is retained after the appliance is switched off. After switching on the appliance, you will need to wait for a few seconds while it reconnects to the network.  In networked standby mode, the appliance requires max. 2 W.
	Connect to app		Start the connection process between the app and the appliance.
	Software update		As soon as a new software version is available, a message appears in the display. You can install the new software in the Home Connect menu  .



## Remote Start

Remote start must be activated in order to start and operate your appliance via the Home Connect app. If remote start is deactivated, only the appliance operating modes can be displayed in the Home Connect app and appliance settings can be implemented.

The remote start is automatically deactivated if the appliance door is opened.

When you start the oven using a type of heating on the appliance itself, remote start is activated automatically. You can now make changes or start a new program from your mobile device.

### Activating remote start

1. Set the function selector to .
2. Touch the  symbol.  
 appears next to the **i** symbol.

Remote start is now activated. You can now use the mobile end device to start a type of heating via the app and transfer the required settings to the appliance.

To deactivate the remote start: Touch the  symbol.

**Note:** You will find the Home Connect settings in the basic settings for your appliance. Which settings the display shows will depend on whether Home Connect has been set up and whether the appliance is connected to your home network.

	Remote control      Activate/deactivate	Access the appliance's functions via the Home Connect app. When deactivated, only the appliance's operating statuses will be displayed in the app.
	Delete network settings	All network settings can be deleted from the appliance at any time.
	Appliance information	The display shows: <ul style="list-style-type: none"> <li>• MAC address COM module</li> <li>• Serial number of the appliance</li> <li>• Software version</li> </ul> You can view more information – such as the SSID (network name), although this depends on the connection type – by touching the arrow button.

## Remote Diagnostics

Customer Service can use Remote Diagnostics to access your appliance if you contact them, have your appliance connected to the Home Connect server and if Remote Diagnostics is available in the country in which you are using the appliance

**Note:** For further information and details about the availability of Remote Diagnostics in your country, please visit the Service/Support section of your local website: [www.home-connect.com](http://www.home-connect.com)

## Information on Data Protection

When your appliance is connected to a WLAN network that is connected to the Internet for the first time, your appliance transmits the following categories of data to the Home Connect server (initial registration):

- Unique appliance identification (consisting of appliance codes as well as the MAC address of the installed Wi-Fi communication module).
- Security certificate of the Wi-Fi communication module (to ensure a secure data connection).
- The current software and hardware version of your appliance.
- Status of any previous resetting to factory settings.

This initial registration prepares the Home Connect functions for use and is only required when you want to use these Home Connect functions for the first time.

**Note:** Ensure that the Home Connect functions can be used only in conjunction with the Home Connect app. Information on data protection can be accessed in the Home Connect app.

## Declaration of Conformity

Gaggenau Hausgeräte GmbH hereby declares that the appliance with Home Connect functionality meets the basic requirements and other relevant provisions of Directive 2014/53/EU.

A detailed RED Declaration of Conformity can be found online at [www.gaggenau.com](http://www.gaggenau.com) among the additional documents on the product page for your appliance.



2.4 GHz band: max. 100 mW  
5 GHz band: max. 100 mW

	BE	BG	CZ	DK	DE	EE	IE	EL
	ES	FR	HR	IT	CY	LV	LT	LU
	HU	MT	NL	AT	PL	PT	RO	SI
	SK	FI	SE	UK	NO	CH	TR	

5 GHz WLAN (Wi-Fi): For indoor use only

## Wi-Fi® Module

### FCC/IC Statements

**Model:** COM2  
**FCC ID:** 2AHES-COM2  
**IC:** 21152-COM2

The Home Connect module is a communication device designed to provide communication between appliances and smart devices.

This module is integrated at the factory, under direct control of BSH Home Appliances Corporation, and is not user servicable or upgradable. At least 7<sup>7</sup>/<sub>8</sub> inch (20 cm) separation distance should be maintained from device to user.

**FCC COMPLIANCE STATEMENT**

---

** CAUTION**

---

Changes or modifications not expressly approved could void your authority to use this equipment.

---

This device complies with Part 15 of the FCC Rules. Operation to the following two conditions:

1. This device may not cause harmful interference, and
2. This device must accept any interference received, including interference that may cause undesired operation.

**INDUSTRY CANADA STATEMENT**

This device complies with Industry Canada license-exempt RSS standard(s).

Operation is subject to the following two conditions:











1. This device may not cause interference, and
2. This device must accept any interference, including interference that may cause undesired operation of the device.











Operation in the band 5150-5250 MHz is only for indoor use to reduce the potential for harmful interference to co-channel mobile satellite systems.

## Basic settings

In the general settings, you can adapt your appliance individually.

1. Set the program selector to **S**.
  2. Select "General setting" with the rotary selector.
  3. Touch the ✓ symbol.
  4. Set the required general setting with the rotary selector.
  5. Touch the ↵ symbol.
  6. Set the general setting with the rotary selector.
  7. Save with ✓ or cancel with ✕ and quit the current general setting.
  8. Turn the program selector to **0** to quit the general setting menu.
- Changes are saved.

	Basic setting	Possible settings	Explanation
	Brightness	Stages 1, 2, 3, 4, 5*, 6, 7, 8	Setting display brightness
	Standby screen	On*/Off - Clock - Clock + GAGGENAU logo* - Date - Date + GAGGENAU logo - Clock + date - Clock + date + GAGGENAU logo	Appearance of the standby screen. Off: no display. Use this setting to reduce the standby consumption of your appliance. On: several displays can be set, confirm "On" with ✓ and choose the desired display with the rotary selector. The selection is displayed.
	Display screen	Minimized*/Standard	When 'Minimized' is set, only the most important details are displayed after a short time.
	Touchpad color	Gray*/White	Select the color of symbols on the touchpads
	Touchpad tone	Tone 1*/Tone 2/Off	Select the signal tone when touching a touchpad
	Touchpad volume	Levels 1, 2, 3, 4, 5*, 6, 7, 8	Sets the volume of the touchpad tone
	Quick heat	On*/off	With quick heat, the required temperature is reached particularly quickly.
	Preheating signal	On*/Off	The signal tone sounds when the required temperature is reached during preheating.
	Signal volume	Levels 1, 2, 3, 4, 5*, 6, 7, 8	Sets the volume of the signal tone
	Time format	AM/PM / 24 h*	Time display in 24 or 12-hour format
	Time	Current time	Setting the time

	Daylight savings	Manual*/Automatic	Automatic time changeover when changing daylight savings time. If automatic: setting of the month, day and week when the time is to be changed. To be set separately for summer and winter time.
	Date format	D.M.Y* D/M/Y M/D/Y	Setting the date format
	Date	Current date	Setting the date. Switch between the year/month/day with the > symbol.
	Temperature unit	°C* / °F	Setting the temperature unit
	Weight unit	kg*/oz.	Set the weight unit
	Language	German* / French [...] / English US / English	Selecting the language for the text display  <b>Note:</b> The system will restart if the language is changed. This process takes a few seconds. The basic settings menu is then closed.
	Factory settings	Restore appliance to factory settings	Confirm the question "Delete all individual settings and restore appliance to factory settings?" with ✓ or cancel with ✕.  <b>Note:</b> When restoring factory settings, the personal recipes are also deleted. After restoring the factory settings, you will see the "Initial settings" menu.
	Demo mode	On/Off*	For presentation purposes only. The appliance does not heat in the demo mode, but all other functions are available.  The "Off" setting must be activated for normal operation. The setting is only possible in the first three minutes after connecting the appliance.
	Sabbath mode	Not available*/Available	Available: Sabbath mode can be set.
	Display estimated cooking time with core temperature probe	On*/off	On: Estimated cooking time is shown in the display when the core temperature probe is used.
	Childproof lock	Not available*/Available	Available: The childproof lock can be activated. → "Childproof lock" on page 31



Home network

- LAN/WLAN Connection type
- Connection
- Connect to app
- Software update
- Remote control
- Delete network settings
- Appliance information

Settings for the connection to the home network and the mobile devices.  
Different setting options will be displayed depending on the connection status.

\* Factory settings

## Cleaning and maintenance

If taken care of and cleaned conscientiously, your appliance will stay beautiful and intact for a long time. Here we explain how to take care of and clean your appliance correctly.

### WARNING

#### Risk of electrical shock!

Moisture entering the appliance can cause an electrical shock. Don't use a high-pressure cleaner or steam cleaner.

### WARNING

#### Risk of burns!

- To avoid risk of injury, never touch the inside surfaces of the oven interior or heating elements. These surfaces are extremely hot after use. Always allow the appliance to cool down before touching or cleaning the interior.
- Always turn off the interior light before cleaning the oven to allow the bulbs to cool down. The bulbs can become very hot when switched on. Keep the light off while cleaning the oven.
- Keep children away.

### WARNING

#### Risk of injury!

Scratched glass in the appliance door can burst. Do not use any glass scrapers or strong or abrasive cleaning agents.

### WARNING

Do not clean the appliance while it is still hot. Some cleaners produce noxious fumes when applied to a hot surface. Wet clothes and sponges can cause burns from steam.

## Cleaning agents

Pay attention to the information in the table to ensure that the various surfaces are not damaged by incorrect cleaning agents.

Do not use any

- sharp or abrasive cleaning agents
- metal or glass scrapers to clean the glass on the appliance door.
- metal or glass scrapers to clean the door seal.
- hard abrasive pads or cleaning sponges.

Thoroughly rinse out new sponge cloths before use.

Area	Cleaning products
Door panels	Glass cleaner: Clean with a soft cloth or a microfiber cloth. Do not use glass scrapers.
Display	Wipe down using a microfiber cloth or a slightly damp cloth. Do not wipe with a wet cloth.
Stainless steel	Hot soapy water: Clean with a dish cloth and dry with a soft cloth. Remove splashes and patches of limescale, grease, starch and albumin (e.g. egg white) immediately. Corrosion can form under these patches or splashes. Special stainless-steel cleaning products are available from our Customer Service or from specialist retailers.

Area	Cleaning products
Aluminum, matt black (inside of the door frame, side panels next to the cooking compartment)	Hot soapy water: Clean with a dish cloth and dry with a soft cloth. Use a fat dissolving agent (article no. 00311781 from our Customer Service or from our online shop) to remove burnt-on remnants and grease. Follow the instructions for use provided with the cleaning product.

**NOTICE**

Risk of surface damage if an unsuitable cleaning product is used. Do not use harsh or abrasive cleaning products.

Cooking compartment	Hot soapy water: Clean with a dish cloth and dry with a soft cloth.
Very dirty cooking compartment	Cleaning gel spray for ovens (order number 00311860 from our Customer Service or our online shop).

**Please note:**

- The gel must not come into contact with the door seal.
- Leave for no more than 12 hours.
- Do not use on hot surfaces.
- Rinse thoroughly with water.
- Follow the manufacturer's instructions.

Glass cover for the cooking compartment light	Hot soapy water: Clean with a dish cloth.
Door seal Do not remove.	Hot soapy water: Clean with a dish cloth; do not scour. Do not use metal or glass scrapers for cleaning.
Core temperature probe	Wipe with a damp cloth. Do not clean in the dishwasher.
Accessories	Hot soapy water: Soak and clean with a dish cloth or brush.
Plug-in grids	Dishwasher; see section entitled → "Removing the plug-in grid" on page 39
Rotary spit	Hot soapy water: Clean with a dish cloth or brush. Do not soak the rotary spit drive or clean it in the dishwasher.
Telescopic shelf (optional accessories)	Hot soapy water: Clean with a dish cloth or brush. Do not soak or clean in the dishwasher.

Area	Cleaning products
Baking stone (optional accessories)	Remove burnt-on remnants with a brush. Never wet the baking stone to clean it.
Roasting dish (optional accessories)	Hot soapy water: Soak and clean with a dish cloth or brush. Do not clean the roasting dish in the dishwasher.

**Microfiber cloth**

The honeycomb microfiber cloth is particularly suitable for cleaning sensitive surfaces such as glass, glass ceramic, stainless steel or aluminum (product no. 00460770, also available from our online online shop). It removes liquid and greasy deposits in one go.

**Removing the plug-in grid**

The plug-in grid can be removed for cleaning.

**Removing the plug-in grid**

1. Put a dish towel in the cooking compartment to protect the enamel from scratches.
2. Undo the knurled screws **A**.
3. Remove the plug-in grid **B**.

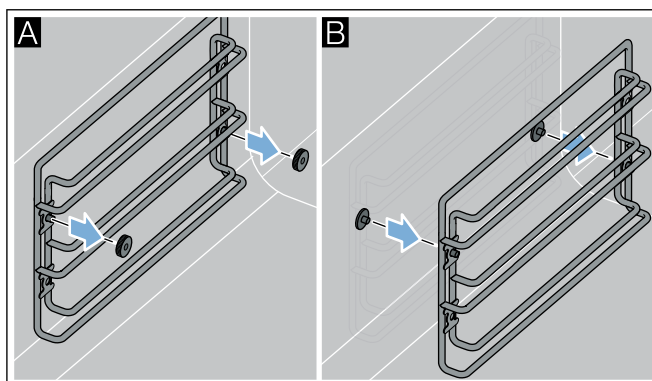

You can clean the plug-in grid in the dishwasher.

**Hooking in the plug-in grid**

**Note:** The right and left grids are identical.

1. Attach the plug-in grid. Ensure that shelf level 3 is at the top (see diagram).
2. Tighten the knurled screws.

---

## Pyrolysis (self-cleaning)

---

During self-clean (pyrolysis), the oven heats up to 905°F (485°C). Thus, remainders from roasting, grilling or baking are burnt up and all you have to do is wipe the ash out of the interior.

Self-clean (pyrolysis) takes three hours. You can move the self-clean switch-off time (for example, if you would like it to run at night).

---

### WARNING

---

During the elimination of soil during self-cleaning, small amounts of Carbon Monoxide can be created and the fiberglass insulation could give off very small amounts of formaldehyde during the first several cleaning cycles. To minimize exposure to these substances, provide good ventilation with an open window, or use a ventilation fan or hood.

Wipe out excessive spillage before self-cleaning the oven.

---

### WARNING

---

#### Risk of fire!

Food remainders, grease or roast juice can catch fire during pyrolytic self-cleaning. Before every pyrolytic self-cleaning, remove coarse soiling from the oven interior and from accessories.

---

### WARNING

---

#### Risk of fire!

The appliance becomes very hot during pyrolytic self-cleaning. Never hang flammable items such as dishcloths on the door handle. Keep the front of the appliance clear. Keep children away.

---

### WARNING

---

#### Severe health risk!

The appliance becomes very hot during pyrolytic self-cleaning. The non-stick coatings on trays and forms are destroyed and toxic gases are produced. Never leave trays and forms with non-stick coatings in the oven during pyrolytic self-cleaning. Only leave enameled accessories in oven during self-clean cycle.

---

### WARNING

---

#### Risk of burns!

The oven interior becomes very hot during pyrolytic cleaning. Never open the appliance door or the latching hook by hand. Allow the appliance to cool down. Keep children away.

---

### WARNING

---

#### Risk of burns!

 The appliance will become very hot on the outside during the cleaning function. Never touch the appliance door. Allow the appliance to cool down. Keep children away from the appliance.

Do not clean parts or accessories in the self-clean oven.

## Preparing the pyrolytic self-cleaning feature

---

### CAUTION





---

Risk of fire! Loose food remnants, fat and meat juices may catch fire. Wipe the cooking compartment with a damp cloth.

- Remove the worst soiling and food residues from the oven.
- Clean the door seals, the inside of the door and the glass pane by hand as these parts are not cleaned during the pyrolytic self-cleaning cycle.
- Remove any loose parts from inside the cooking compartment. The plug-in grids are pyrolysis-proof. Make sure that nothing is left inside the cooking compartment.
- Bush for the additional heating element at the back of the cooking compartment: Make sure that the cover is in the bush.
- Close the oven door.



## Starting the pyrolytic self-cleaning function

1. Set function selector to **S**.
2. The + symbol is displayed. Press  to confirm.
3. The switch-off time at which the pyrolytic self-cleaning function will be finished is displayed. If desired, change the switch-off time with the rotary selector. Press  to confirm.
4. Remove all accessories from the oven cavity and remove any coarse dirt. Press  to confirm.
5. Press  to start. The cleaning time counts down on the display. If the switch-off time has been delayed, the time until the pyrolytic self-cleaning function starts counts down in the display. The light in the oven cavity remains switched off.



A signal sounds once the pyrolytic self-cleaning function has ended. A message appears in the display. Once the appliance has cooled down, wipe out the ash that has been left behind in the oven cavity with a damp cloth.

### Notes

- The total duration of the pyrolytic self-cleaning function comprises the cleaning time and cooling period. The time for the relevant section of the pyrolytic self-cleaning function counts down on the display.
- For safety reasons, the oven door locks automatically. During cooling, the door mechanism is opened as soon as the temperature falls below 390°F (200 °C).

Depending on the type of soiling, white deposits may remain on the enamel surfaces. These deposits are residue from the food and are harmless. They do not affect how the appliance works. If required, you can remove these residues using lemon juice and a soft cloth.

## Cleaning the Accessories with the Pyrolytic Self-cleaning Feature

Gaggenau baking trays and broiler pans are coated with pyrolysis-resistant enamel. For optimal results when cleaning the oven, we recommend removing all accessories from the oven before initiating the pyrolytic self-cleaning feature. This is the only way to achieve even heat distribution.

If you wish to remove burnt-on residue from your baking tray or broiler pan with the pyrolytic self-cleaning cycle, please observe the following instructions:

### Notes

- Remove the worst soiling, meat juices, and food residues before initiating the pyrolytic self-cleaning cycle. Food residues, grease, and meat juices may catch fire during the pyrolytic self-cleaning cycle.
- Slide only one baking tray or broiler pan onto the lowest rack in the oven.
- Push the baking tray or broiler pan in as far as it will go.
- Wire rack, rotisserie spit, cast iron roaster, baking stone, core temperature sensor, or other accessories must not be cleaned in the pyrolytic self-cleaning cycle.
- Broiler pans with stainless steel bushings can discolor during the pyrolytic self-cleaning cycle. This does not affect its usability.



## Troubleshooting

You can often easily eliminate problems that may occur on your own. Before calling Customer Service, take into account the following information.

### WARNING

#### Risk of electric shock!

Improper repairs are dangerous. Only an authorized service provider may perform repairs and may replace damaged plug and connections. Remove the power plug or turn off the circuit breaker or fuse in the fuse box if the appliance is damaged or not working. Call Customer Service.

Disruption	Possible cause	Solution
Appliance not working, no display	Plug not inserted	Connect the appliance to the electricity mains
	Power failure	Check whether other kitchen appliances are working
	Fuse defective	Check in the fuse box whether the fuse for the appliance is in working order
	Operating error	Switch off the fuse for the appliance in the fuse box and switch it on again after about 10 seconds
Appliance cannot be started	Appliance door is not quite closed	Close appliance door
Appliance is not working, display is not responding.  appears in the display.	Child lock activated	Deactivate child lock (see section entitled 'Child lock')
Appliance switches off automatically	Safety deactivation: the appliance has not been operated for longer than 12 hours	Confirm the message with  , switch off the appliance and set it again.
Appliance does not heat up,  appears in the display	Appliance is in the demo mode	Deactivate demo mode in the basic settings
Error message "Exxx"		If an error message appears, turn the program selection to <b>0</b> ; if the display goes off, it was a one-time problem. If the problem occurs repeatedly or if the display stops, please contact after-sales service and inform them of the error code.

### Power cut

Your appliance can bridge a power cut of a few seconds. Operation continues.

If the power cut was for a longer period and the appliance was in operation, a message appears in the display. Operation is interrupted.

Set the function selector to **0**, then the appliance can be operated again as usual.

### Demo mode

The demo mode is activated if the  symbol appears in the display. The appliance does not heat up.

Briefly disconnect the appliance from the mains (switch off the domestic fuse or the circuit-breaker in the fuse box). Then deactivate the demo mode within 3 minutes in the factory setting. → *"Basic settings" on page 36*

## Replacing the oven lamp

You can replace the oven lamps. You can obtain replacement lamps after-sales service or from trade dealers. Use the same type of halogen bulbs only.

- Top lamp:  
60 W/230 V/G9
- Side lamp: 10 W/12 V/G4

---

### **WARNING**

#### **Risk of electric shock!**

When you replace the oven interior lamp, the contacts of the lamp holder are live. Before replacing the lamp, remove the power plug or deactivate the circuit breaker or fuse in the fuse box.

---



---

### **WARNING**

#### **Risk of burns!**

Lamps become very hot when switched on. There is still a risk of burning your skin for some time after they have been switched off. Allow lamps to cool down before replacing them.

---

**Note:** Always use a dry cloth to remove the halogen lamp from its packaging. This lengthens the lamp's useful life.

## Replacing the top oven lamp

1. Undo the screw on the lamp cover. The lamp cover folds down.
2. Take out the halogen lamp. Insert the new halogen lamp.
3. Fold up and screw down the lamp cover.
4. Switch on the fuse in the fuse box again.

## Replacing the side oven lamp

1. Place a dishcloth in the oven to avoid damage.
2. Undo the knurled screws on the slide-in rack. Remove the slide-in rack.
3. Press the top retaining spring to the side. Remove the glass cover.
4. Take out the halogen lamp. Insert the new halogen lamp.
5. Insert the glass cover at the bottom into the retaining spring and latch it at the top. The beveled side of the glass cover must point toward the oven.
6. Remove the dishcloth from the oven.
7. Switch on the fuse in the fuse box again.

## Replacing the glass cover

The glass cover in the oven must be replaced if it is damaged. You can obtain covers from after-sales service. Always specify the E number and the FD number of your appliance.

---

## Customer service

---

If your appliance needs repairs, our Customer Service is there for you. We work hard to help solve problems quickly and without unnecessary service calls, getting your appliance back up and running correctly in the least amount of time possible.

When you call, please indicate the product number (E-Nr.) and serial number (FD-Nr.) so that we can support you in a qualified manner. You will find the type plate with these numbers on the bottom of the appliance. To avoid having to search for a long time when you need it, you can enter your appliance data and the Customer Service telephone number here.

E-Nr.	FD-Nr.
<b>Customer Service</b> ☎	

Please read the use and care instructions provided with your appliance. Failure to do so may result in an error in using the appliance. This could result in a service call that instead of fixing a mechanical issue is only needed for customer education. Such calls are not covered by the appliance warranty.

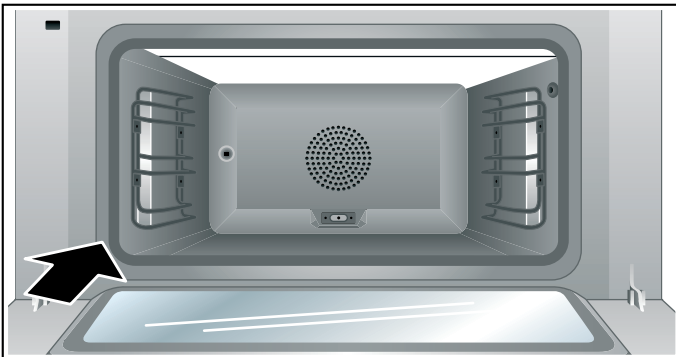

Please find the contact data of all countries in the enclosed customer service list.

### To book a service visit and product advice

**USA** 877 442 4436  
toll-free

**CANADA** 877 442 4436  
toll-free

---

## Tables and tips

---

- Always preheat the appliance. This will produce the best cooking results. The cooking times specified refer to a preheated appliance.
- The values specified are intended as a guide. The actual cooking times depend on the quality and temperature of the food before cooking, and the weight and thickness of the food to be cooked.
- The tables list temperature and/or time ranges. Try the lowest value to start with. You can always choose a longer time next time if need be.  
A lower temperature results in more even browning. If necessary, set a higher temperature.
- The figures listed refer to average quantities of food for four to six people.

The size of the oven allows large quantities of food to be cooked. If you wish to cook a larger quantity of food, you should extend the cooking time by 5 - 10 minutes.

- Use the cookware specified. If you use other cookware, cooking times may be longer or shorter.
- You may use any heat-resistant cookware. Place the cookware in the center of the wire rack. For large roasts, you can also use the grill or glass tray.
- Do not place too many items close together on wire racks or baking trays. This is the only way to ensure optimal heat circulation.
- Open the door of the preheated oven for a short time only when placing food inside the oven cavity.
- The figures given for the level refer to the rack level counting from the bottom.
- When removing glass cookware from the oven, set it down on a dry trivet, never on a cold or wet surface. Otherwise, the glass may crack.
- For the roasting dish function and baking stone function, you will need to use optional accessories.
- **Economy:**

Energy-saving convection mode for cakes, meat, bakes and gratins. Optimal use is made of the residual heat. Convenience functions remain switched off (e.g. the interior lighting). The cooking compartment temperature can only be displayed while the appliance is heating up. Do not preheat the oven.

Make sure that the cooking compartment is cold and that there is nothing already in there when you place the food inside. Then start the specified cooking time. Always keep the appliance door closed when cooking. This will prevent heat loss.

- **Broil and Broil + circulated air:**

In these heating modes, there may be a temperature difference between the temperature you have set and the actual temperature inside the oven. This is because broiling and browning are fast cooking

processes that require high temperatures.

Consequently, for browning and broiling, a higher temperature than is actually needed on the surface of the food is selected.

## Vegetables

- Oven-roasted vegetables are a good alternative to pan-fried vegetables. The different flavors become more concentrated and, because the vegetables are roasted, they have a very distinctive taste. In addition, very little fat is required to prepare the vegetables.
- Clean and prepare the vegetables and mix them with a little oil in a bowl. Place them in a heat-resistant baking dish or in the grill tray and spread them out evenly.
- Mix them thoroughly at least once during the cooking process. Once they are cooked, season them and sprinkle them with fresh herbs to taste.
- Vegetables are good as a hot or cold starter or vegetarian main course, or as an accompaniment to meat and fish.
- For small portions (for 2-3 people), use an ovenproof dish and place it on the wire rack. If you use the glass dish/grill tray, the food will start to burn or dry out.
- Always follow the manufacturer's instructions for pre-cooked and frozen products.

Dish	Accessories	Level	Temperature in °F (°C)	Type of heating	Cooking time in min.	Observations
Vegetable skewers	Wire rack + Grill tray	3	430 (220)	~~~~~	24*	Cut wooden skewers short or soak in water overnight so they do not burn. Recipe tip: peppers, onions, corn (pre-cooked), cherry tomatoes, zucchini
Green asparagus, grilled	Grill tray	3	430 (220)	~~~~~	6 - 10*	Recipe tip: season with onions, oil, vinegar, salt, and pepper. Adjust the cooking time depending on size.
Root vegetables	Grill tray	2	390 (200)	✚	30*	Recipe tip: Season carrots, celery, rutabagas and red beets with oil, salt, and pepper.
Pumpkin pieces	Grill tray	2	390 (200)	✚	20 - 30*	Recipe tip: Season with oil, garlic, ginger, cumin, salt, and pepper.
Antipasti	Grill tray	3	480 (250)	~~~~~	15 - 20*	Recipe tip: Drizzle balsamic vinegar over the vegetables while they are still hot, and season them.
Escalivada (Mediterranean oven-roasted vegetables)	Ovenproof dish + wire rack	3	535 (280)	~~~~~	15 - 20*	Recipe tip: eggplant, onions, tomatoes, peppers, oil. Tastes good warm and cold.
Ratatouille	Grill tray	2	390 (200)	---	35 - 40*	Recipe tip: Sprinkle with parmesan just before serving.
Baked tomatoes	Ovenproof dish + wire rack	2	250 (120)	✚	60	Recipe tip: Place cherry tomatoes or sliced tomatoes, rosemary, and garlic into the baking dish and drizzle with oil and a little honey.  If you wish, you can blanch the tomatoes and skin them before roasting them in the oven.

\* Turn food halfway through the cooking time.

Dish	Accessories	Level	Temperature in °F (°C)	Type of heating	Cooking time in min.	Observations
Chicory	Ovenproof dish + wire rack	2	355 (180)	✿	30	Recipe tip: Halve, season, wrap in cooked ham, top with cream or Béchamel sauce, and sprinkle with cheese.
		2	355 (180)	✿ <sup>e</sup>	60	No need to preheat; do not open appliance door.
Vegetable bake	Ovenproof dish + wire rack	2	355 (180)	✿	40 - 50	Pre-cook/blanch vegetables and other ingredients.

\* Turn food halfway through the cooking time.

## Side dishes and dishes

- The best-known oven-cooked side dishes are potato-based, such as potato gratin. However, you can also obtain excellent results when oven-cooking side dishes that are normally pan-fried, e.g. potato pancakes or fried potatoes. The advantages of this preparation method: You can prepare relatively large quantities of food at the same time, the cooking smells do not spread so far in the room, and the food can be prepared using less fat.
- Another highly versatile oven-cooked side dish is cheese. It is a very good addition to vegetarian dishes in particular; or depending on the preparation method, you can also serve cheese as a starter or finger food.
- Grilled dishes such as bakes and gratins are particularly well suited to being prepared in the oven. Dishes with a dough or pastry base, e.g. pizza and savoury flan, and egg dishes with a filling, e.g. tortillas, are also suitable.
- For small portions (for 2-3 people), use an ovenproof dish and place it on the wire rack. If you use the glass dish/grill tray, small portions will start to burn or dry out.
- Always follow the manufacturer's instructions for pre-cooked and frozen products.

Dish	Accessories	Level	Temperature in °F (°C)	Type of heating	Cooking time in min.	Observations
<b>Side dishes</b>						
Potatoes on a bed of coarse salt	Ovenproof dish + wire rack	2	390 (200)	---	60*	Fill the ovenproof dish with $\frac{9}{16}$ " (1.5 cm) of sea salt. Place small potatoes in the dish with their skins on and brush them with olive oil.
Potato wedges	Baking sheet + parchment paper	2	390 (200)	✿	20 - 25*	Recipe tip: cut the potatoes into wedges, season with olive oil, paprika, and salt.
French fries, fresh	Baking sheet + parchment paper	3	390 (200)	✿	15 - 30*	Recipe tip: Cover with a little oil, and after cooking, season with salt and paprika or curry powder.
French fries, frozen	Baking sheet + parchment paper	2	430 (220)	✿	14 - 16*	Spread out the frozen fries well on the baking tray.
Potato gratin	Ovenproof dish + wire rack	2	355 (180)	✿	45	
		2	355 (180)	✿ <sup>e</sup>	75	No need to preheat; do not open appliance door.

\* Turn food halfway through the cooking time.

Dish	Accessories	Level	Temperature in °F (°C)	Type of heating	Cooking time in min.	Observations
Potato pancakes	Baking sheet	2	345 (175)	✿	30*	Oil the baking tray liberally, squeeze out the excess liquid from the potato pancake mixture and brush with a little oil.
Goat cheese wrapped in bacon	Baking sheet + parchment paper	2	430 (220)	✿	6	Fresh goat's cheese or goat camembert works well.
Goat's cheese with honey	Baking sheet + parchment paper	2	390 (200)	✿	6	Recipe tip: Drizzle lavender honey over the goat's cheese or goat camembert and sprinkle with pine nuts.
Baked camembert, breaded, frozen	Baking tray + grease-proof paper	2	355 (180)	✿	20	Bake until the breadcrumb coating rises in the center.
Mozzarella sticks, frozen	Baking tray + grease-proof paper	2	355 (180)	✿	8	
Feta	Ovenproof dish + wire rack	2	480 (250)	☼	12	Recipe tip: Place feta cubes in a dish with oil, tomatoes, onion, garlic and rosemary and season with salt and pepper.
Oven-baked cheese, fresh	Baking sheet	2	355 (180)	✿	20	After 10 minutes, cut a cross into the soft cheese and break open. If possible, the baking dish should be not much larger than the cheese so that the cheese does not run.
<b>Dishes</b>						
Tortillas	Ovenproof dish + wire rack	2	320 (160)	---	25	Recipe tip: with paprika, olives, onion, Serrano ham, and Manchego cheese.
Farmers' omelette	Ovenproof dish + wire rack	2	320 (160)	✿	40	Recipe tip: with green and white asparagus, serve with gravéed lox.
Frittata	Ovenproof dish + wire rack	2	375 (190)	---	40 - 45	Recipe tip: with spinach, onions, and shrimp.
Enchiladas, au gratin	Ovenproof dish + wire rack	2	390 (200)	---	10 - 15	
Lasagne	Ovenproof dish + wire rack	2	345 (175)	✿	40	Recipe tip: classic or vegetarian with grilled vegetables and Buffalo mozzarella.
		2	345 (175)	✿ <sup>e</sup>	70	No need to preheat; do not open appliance door.
Macaroni and cheese	Ovenproof dish + wire rack	2	355 / 430 (180 / 220)	✿	20	For a cheesy crust, increase the temperature to 430° F (220° C) after 10 min. and let brown for 10 min.

\* Turn food halfway through the cooking time.

Dish	Accessories	Level	Temperature in °F (°C)	Type of heating	Cooking time in min.	Observations
Cheese spätzle (Swabian noodle dish)	Ovenproof dish + wire rack	2	355 / 430 (180 / 220)	✦	30	Gradually layer the freshly-cooked spätzle in the baking dish, sprinkling each layer with cheese.  Finally, top with cheese and roasted onions and increase the temperature to 430° F (220 °C) for 5 min.
Mini spring rolls, frozen	Baking sheet + parchment paper	2	410 (210)	✦	15*	
Pizza, fresh	Baking sheet	2	480 (250)	---	8 - 12	Lightly grease the baking sheet or line it with parchment paper.
Pizza, frozen	Wire rack	2	390 (200)	✦	13	
American pizza (deep pan), frozen	Baking sheet	2	390 (200)	---	20 - 24	Do not preheat. If the oven has been preheated, reduce the cooking time by 4 minutes.
Tarte flambée, fresh	Baking sheet	2	480 (250)	---	7 - 9	Recipe tip: classic or with fresh goat's cheese, Parma ham, figs, and spring onions.
Tarte flambée, frozen	Wire rack	2	430 (220)	✦	10 - 12	
Quiche	Tart tin + wire rack	2	390 (200)	---	15 + 20	Prick the base several times with a fork and prebake for 15 minutes. Pour the mixture onto the base and then bake for a further 20 minutes.
Onion tart	Tart tin + wire rack	2	390 (200)	---	40 - 50	Prick the base several times with a fork.

\* Turn food halfway through the cooking time.

## Fish

- For food hygiene reasons, fish should have a core temperature of at least 144 - 158° F (62 - 70 °C) after cooking. This is also the ideal cooking point.
- Only salt the fish after cooking. Thus the natural aroma is retained and less water is removed from the fish.
- Lightly grease the wire rack and baking sheet or line it with parchment paper. This prevents the fish from sticking to the wire rack.
- For fillets with skin: Place the fish on the rack or tray with the skin side up – this helps to hold the fish together and maintains its flavor.
- Cut wooden skewers short or soak in water overnight before skewering the ingredients so they do not burn.
- If you are using the grill tray with the wire insert, pour approximately 1/2 cup (100 ml) water into the grill tray; this will catch the fish juices so that the oven stays clean. If you pour in too much water, this may alter the cooking result because too much steam will be produced.
- Always follow the manufacturer's instructions for pre-cooked and frozen products.



Dish	Accessories	Level	Temperature in °F (°C)	Type of heating	Cooking time in min.	Observations
Shrimp skewers, fresh	Wire rack + Grill tray	3	355 (180)	~~~~~	10*	
Shrimp, deveined, frozen	Wire rack + Grill tray	2	355 (180)	✿	14*	
Fish kebabs	Wire rack + Grill tray	3	390 (200)	~~~~~	12 - 14*	Use firm types of fish, e.g. salmon, ocean perch and cod.
Trout, whole	Baking tray + grease-proof paper	3	430 (220)	~~~~~	16*	Recipe tip: Stuff with lemon, garlic, and parsley.
Sea bream, whole	Baking tray + grease-proof paper	3	375 (190)	✿	20 - 25*	Recipe tip: Stuff with lemon, garlic and thyme, or use mint for a summery touch. Make a diagonal incision into the skin of the sea bream.
Sea bass (1 kg)	Baking tray + grease-proof paper	2	345 (175)	✿	30 - 35*	
Salmon steak	Baking tray + grease-proof paper	3	390 (200)	✿	10 - 12	Recipe tip: Marinate in a mixture of lime, salt, pepper, and garlic.
Tuna steak	Baking tray + grease-proof paper	2	390 (200)	✿	8 - 10	Recipe tip: Season Asian-style with soy sauce, sesame oil, ginger, honey, garlic, chili, and coriander seeds.
Squid rings, frozen	Baking tray + grease-proof paper	2	430 (220)	---	12	

\* Turn food halfway through the cooking time.

## Meat

- Use the core temperature sensor so that you can monitor the core temperature more easily.
- If you are using the grill tray with the wire insert, pour approximately 1/2 cup (100 ml) water into the grill tray; this will catch the meat juices so that the oven stays clean. If you pour in too much water, this may alter the cooking result because too much steam will be produced.
- Let meat rest for 10 - 15 min. after cooking. This gives the meat a chance to "relax". The circulation of the meat juice slows down and there less juice is lost when the meat is cut. Large pieces of meat, such as roasts, can rest in the oven. Smaller pieces of meat should be wrapped in aluminum foil and left to rest outside the oven.
- For small portions (2 - 3 people), use a heat-resistant pan so that the food does not burn or dry out.
- Use the wire rack or the roasting dish for a large roast and for types of preparation that generate a lot of liquid for roasting.
- For best results, leave meat to marinate overnight and remove it before roasting or grilling, e.g. using the back of a knife or a spoon. Otherwise, the herbs and spices will burn.
- If the roast gets too dark and the crust is burned in places, reduce the temperature the next time and check the rack level.
- If the roast is cooked but the sauce is burned on, next time use a smaller roasting dish and add more liquid. If the sauce is too watery, next time use a larger roasting dish and add less liquid.

Dish	Accessories	Level	Temperature in °F (°C)	Type of heating	Cooking time in min.	Observations
<b>Beef</b>						
Roast beef, 3.3 lb (1.5 kg)	Grill tray	2	355 (180)	✿	60 - 90*	
Rump steak, medium rare, 15.9 oz (450 g)	Grill tray	2	390 (200)	✿	28	Core temperature 150° F (65 °C)
		2	390 (200)	✿ <sup>e</sup>	43	Core temperature 150° F (65 °C). No need to preheat; do not open appliance door.
Roast beef/sirloin, 2.2 lb (1 kg) - rare	Grill tray	2	445 / 355 (230 / 180)	✿	25 - 35**	Recipe tip: delicious with Béarnaise sauce or sliced cold with remoulade and roasted potatoes.
- medium rare	Grill tray	2	445 / 355 (230 / 180)	✿	30 - 40**	
- well-done	Grill tray	2	445 / 355 (230 / 180)	✿	50 - 60**	
<b>Pork</b>						
Fillet of pork, whole, 0.4 lb (400 g)	Grill tray	2	445 / 355 (230 / 180)	✿	25**	Recipe tip: Marinate with oil, garlic, and parsley.
Fillet of pork, 0.6 lb (260 g)	Grill tray	2	355 (180)	✿	28	Core temperature 160° F (70 °C).
		2	355 (180)	✿ <sup>e</sup>	41	Core temperature 160° F (70 °C). No need to preheat; do not open appliance door.
Pork roast - joint, 2.2 lb (1 kg)	Grill tray	2	445 / 355 (230 / 180)	✿	45 - 50**	Cut roughly into skin so that it gets crusty.
Pork roast - neck, 3.3 lb (1.5 kg)	Grill tray	2	445 / 355 (230 / 180)	✿	95**	
Pork roast with crust, 3.3 lb (1.5 kg)	Wire rack + Grill tray	2	355 / 390 (180 / 200)	✿ <sup>e</sup>	70 - 80***	Cut roughly into skin so that it gets crusty. Before cooking, boil the roast with crust in water for 10 minutes.
Pork knuckle	Wire rack + Grill tray	2	300/ 390 (150 / 200)	✿ <sup>e</sup>	50***	Cut roughly into skin so that it gets crusty. Before cooking, boil the roast with crust in water for 90 minutes.
Rolled pork	Grill tray	2	355 / 390 (180 / 200)	✿	70***	
<b>Veal</b>						
Joint of veal, medium rare, 3.3 lb (1.5 kg)	Grill tray, roasting dish	2	445 / 355 (230 / 180)	✿	50 - 55*	
Veal knuckle	Grill tray, roasting dish	2	300/ 355 (150 / 180)	✿ <sup>e</sup>	70***	
Veal loin	Grill tray, roasting dish	2	340 (170)	✿	40	

\* First, sear on all sides in a frying pan/roasting dish on the burner.

\*\* Brown the meat at a high temperature, after 15 - 20 min. set the lower temperature.

\*\*\* Cook meat at a low temperature, set the temperature higher for the last 15 - 20 min.

Dish	Accessories	Level	Temperature in °F (°C)	Type of heating	Cooking time in min.	Observations
<b>Game</b>						
Saddle of lamb	Grill tray, roasting dish	2	330 (165)	✿	20	
Saddle of hare or rabbit	Grill tray, roasting dish	2	355 (180)	✿	20 - 25*	Recipe tip: Marinate in garlic, rosemary, olive oil, and high-quality balsamic vinegar.
Leg of lamb, 5.5 lb (2.5 kg) - medium rare	Grill tray, roasting dish	2	355 (180)	✿	100*	Recipe tip: Marinate overnight in olive oil, garlic, rosemary, and lemon peel.
- well-done	Grill tray, roasting dish	2	355 (180)	✿	120*	
Knuckle of lamb	Grill tray, roasting dish	2	355 (180)	✿	45	
<b>Miscellaneous</b>						
Meatballs, lightly fried, 2.8 oz each (80 g each)	Baking tray + grease-proof paper	2	390 (200)	✿	20	Nicely browned yet juicy meatballs: First, fry them lightly in the frying pan, then put them in the oven.
Meatballs, lightly fried, 0.9 oz (25 g each)	Baking sheet + parchment paper	2	390 (200)	✿	15	Recipe tip: Place meatballs made from minced lamb or rabbit on skewers and serve with mint yoghurt or fig mustard.
Meat loaf, fresh, 24.7 oz (700 g)	Wire rack + Grill tray	2	320 (160)	✿	60	Use core temperature sensor (core temperature 153° F (67 °C)).
Bacon strips (Fried bacon), thin	Baking sheet + parchment paper	2	355 (180)	✿	8 - 10	Once you have taken the bacon out of the oven, place it on some kitchen towel to soak up the fat.
Stuffed peppers with ground meat	Ovenproof dish	2	375 (190)	✿	30 - 40	Recipe tip: Fill with ground meat and cook in tomato sauce.

\* First, sear on all sides in a frying pan/roasting dish on the burner.

\*\* Brown the meat at a high temperature, after 15 - 20 min. set the lower temperature.

\*\*\* Cook meat at a low temperature, set the temperature higher for the last 15 - 20 min.

## Poultry

- Use the core temperature sensor so that you can monitor the core temperature more easily. Insert this between the belly and upper thigh, rather than in the middle (cavity) of the bird.
- Poultry will turn out particularly crispy and brown if you baste it towards the end of the roasting time with butter, oil, salted water, drained fat or orange juice.
- When cooking duck or goose, pierce the skin underneath the wings to allow the fat to run out.
- Use a roasting dish or another heat-resistant baking pan for dishes that involve adding a lot of liquid to the roast. The same applies if a lot of fat is likely to drain from the food, e.g. for roast goose.
- If you are using the grill tray with the wire insert, pour approximately 1/2 cup (100 ml) water into the grill tray; this will catch the meat juices so that the oven stays clean. If you pour in too much water, this may alter the cooking result because too much steam will be produced.









Dish	Accessories	Level	Temperature in °F (°C)	Type of heating	Cooking time in min.	Observations
Duck, whole, 3.3 - 4.4 lb (1.5 - 2 kg)	Wire rack + Grill tray	2	320 / 355 (160 / 180)	---	80*	Recipe tip: Stuff with oranges, apples, or dried fruit.
Goose, whole, 7.7 lb (3.5 kg)	Wire rack + Grill tray	2	320 / 375 (160 / 190)	✿	110 - 130*	Recipe tip: Stuff with apples, onions and marjoram and pin the opening closed with a cocktail stick or similar sharp item.
Turkey, whole, 11 lb (5 kg)	Wire rack + Grill tray	2	390 / 320 (200 / 160)	✿	120 - 180*	
Chicken, whole, 2.2 lb (1 kg)	Wire rack + Grill tray	2	355 (180)	✿	50 - 60	Baste with oil, salt, pepper, paprika, and curry powder. Preheat. Can be cooked on the rotary spit.
		2	355 (180)	⚙	50	Can be cooked on the rotary spit.
Chicken, legs and thighs	Wire rack + Grill tray	3	430 (220)	⚙	30 - 35**	Recipe tip: Asian marinade with soy sauce, honey, chili, garlic, ginger, cumin, lime rub, coriander.
Chicken legs	Wire rack + Grill tray	3	430 (220)	⚙	30 - 35**	After the leg is turned, the side with more skin should be at the top. This makes it nice and crispy.  Marinate in a mixture of oil, rosemary, sliced lemon and garlic
Chicken breast	Wire rack + Grill tray	2	390 (200)	✿	20 - 25	Recipe tip: Rub with tandoori paste before cooking. The cooking time depends on the size of the breast.
		2	390 (200)	✿ <sup>e</sup>	45	No need to preheat; do not open appliance door.
Chicken nuggets, frozen	Baking sheet + parchment paper	2	390 (200)	✿	15**	
Quail, whole, 5.3 oz (150 g each)	Wire rack + Grill tray	3	390 (200)	⚙	25	Baste with oil and seasoning/spices, e.g. paprika, thyme, juniper and garlic.

\* Cook the meat at a low temperature; set it to cook at the higher temperature for the last 15 - 20 minutes.

\*\* Turn food halfway through the cooking time.



## Grilling and roasting

- Do not grill food with the oven door open.
- Use the grill tray with inlaid shelf for grilling (depending on the version, accessory or special accessory). Pour approximately  $\frac{1}{2}$  cup (100 ml) water into the grill tray; this will catch the meat juices so that the oven stays clean. If you pour in too much water, this may alter the cooking result because too much steam will be produced.
- The pieces of food to be grilled should be of roughly the same thickness, at least  $\frac{13}{16}$ " to  $1\frac{3}{16}$ " (2 to 3 cm). This will allow them to brown evenly and remain succulent and juicy. Never add salt to meat before grilling it. Place the pieces to be grilled directly on the wire rack.
- If you use wooden skewers, these can burn. In order to prevent this, cut the skewers as short as possible or soak them overnight in water before spearing the ingredients, or use metal skewers.
- For small quantities, use the energy-saving "Compact grill" heating function. With this heating function, only the center part of the grill is heated. Place the food to be grilled in the middle of the wire rack.

Dish	Accessories	Level	Temperature in °F (°C)	Type of heating	Cooking time in min.	Observations
Kebab skewers	Wire rack + Grill tray	3	375 (190)		14 - 16*	
Bratwurst	Wire rack + Grill tray	3	520 (270)		10*	
Merguez (grilling sausage)	Wire rack + Grill tray	3	480 (250)		10 - 12*	
Spare ribs	Wire rack + Grill tray	3	430 (220)		40*	Recipe tip: Place in a mixture of oil, mustard, balsamic vinegar, honey, garlic, Worcester sauce, tomato purée and Tabasco sauce.
Chicken Satay	Wire rack + Grill tray	3	480 (250)		14*	Serve with peanut sauce.
Toasting open-faced sandwiches	Wire rack	3	390 (200)		1:30 - 2	Preheat for up to 5 minutes. Remain near the appliance so that the sandwiches do not burn. Do not grill food with the oven door open.
Toast Hawaii	Baking tray + grease-proof paper	3	375 (190)		8 - 10**	
Croque Monsieur	Baking tray + grease-proof paper	3	375 (190)		8 - 11**	

\* Turn food halfway through the cooking time.

\*\* Brown to the level you require.



Dish	Accessories	Level	Temperature in °F (°C)	Type of heating	Cooking time in min.	Observations
Croutons	Baking sheet	2	355 (180)		12*	Recipe tip: mix fresh white bread with olive oil, garlic, and rosemary needles. Do not use too much oil, and do not pour it on until you are ready to serve so that the bread cubes do not get soggy. Turn several times.
Browning meringue (on pies)	Spring-form cake pan + wire rack	2	430 (220)		2**	Stay by the appliance so that the meringue does not brown too much.

\* Turn food halfway through the cooking time.

\*\* Brown to the level you require.

## Baked goods

- We recommend using dark-colored metal baking pans as these absorb heat more effectively. Place the pan in the middle of the wire rack.
- For sheet cakes without parchment paper, oil the pan slightly.
- Small baked items e.g. cream puffs, cookies and puff pastry parcels, can be baked on two levels at once. Use levels 1 and 3 and the heating type "Hot air".
- If you are baking on more than one level, it is normal for food on baking trays placed in the oven at the same time to be ready at different times. Leave the food on the baking trays lower down in the oven to cook for a little longer, or place them in the appliance earlier next time.
- Before cutting the baked items, leave them to cool on a wire rack.
- If the baked goods are too dark on the bottom, place them a level up and select a lower temperature.  
If the baked items are too dark on the top, place them a level down, select a lower temperature, and extend the baking time a little.
- If the cake is too dry, set the temperature a little higher and reduce the cooking time. If the cake remains uncooked in the middle, set a lower temperature and increase the cooking time.  
To achieve a uniform cooking result, it is better to set the temperature a little lower.
- If the cake collapses: use less liquid or set the temperature 50° F (10 °C) lower. Do not open the oven door too soon.
- If the cake rises only in the middle: grease the edges of the pan.
- If the cookies are hard to take off the sheet, insert the sheet in the hot oven again and remove the cookies while they are still warm.
- If the cake does not come away from the tin when you are trying to turn it out, carefully slide a knife around the sides to loosen it. Turn the cake pan upside down again and cover it several times with a cold, wet cloth. Next time, grease the pan well and sprinkle some bread crumbs into it.
- In addition, always follow the manufacturer's instructions for pre-cooked and frozen products.

Dish	Accessories	Level	Temperature in° F (°C)	Type of heating	Cooking time in min.	Observations
Cake	Spring-form cake pan + wire rack	1	330 (165)		60 - 70	
		1	330 (165)		65 - 75	

\* Pre-heat the appliance to the specified temperature. When putting in the food to be cooked, switch back to the second specified temperature.

Dish	Accessories	Level	Temperature in ° F (°C)	Type of heating	Cooking time in min.	Observations
Sponge cake	Spring-form cake pan + wire rack	1	330 (165)	✿	50 - 60	
Loaf cakes	Loaf pan + wire rack	2	320 (160)	✿	60	To ensure even browning, place the pan lengthwise in the cooking compartment.
		2	320 (160)	✿ <sup>e</sup>	60	For moist cakes.
Bundt cake, Ring cake	Ring cake pan + wire rack	1	330 (165)	✿	40	Recipe tip: classic Bundt cake or with bacon and walnuts.
		1	330 (165)	✿ <sup>e</sup>	70	No need to preheat; do not open appliance door.
Sheet cakes	Baking sheet	2	330 (165)	✿	25 - 35	Lightly grease the baking sheet or line it with parchment paper.
Swiss roll	Baking sheet + parchment paper	2	375 (190)	✿	7 - 9	Place dough on parchment paper sprinkled with sugar, then roll up.
Sponge base	Spring-form cake pan + wire rack	2	300 (150)	✿	40 - 45	Line a springform cake pan with parchment paper.
Yeast sheet cake	Baking sheet	2	330 (165)	✿	30 - 40	Recipe tip: Top with plums, figs or onions and bacon. Lightly grease the baking sheet or line it with parchment paper.
Fruit flan on a shortcake base	Tart tin + wire rack	2	330 (165)	✿	45 - 50	Recipe tip: Top with strawberries or with apricots and marzipan.
		2	330 (165)	✿ <sup>e</sup>	45 - 55	
Tart	Tart tin + wire rack	2	375 (190)	✿	35	French flan with a shortcake base, e.g. tarte aux pommes, tarte tatin, tarte au chocolat, tarte au citron.
		2	375 (190)	✿ <sup>e</sup>	35	
Apple pie (according to EN 60350-1)	7 7/8" (20 cm) springform cake pan + wire rack	2	320 (160)	✿	90 - 105	Pre-heat
Cake base (according to EN 60350-1)	10 1/4" (26 cm) springform cake pan + wire rack	2	300 (150)	✿	25 - 35	Pre-heat
<b>Small baked goods</b>						
Cream puffs, eclairs	Baking sheet + parchment paper	2	355 (180)	✿	35	Recipe tip: Fill with vanilla cream, chocolate mousse, fruit or mocha cream.
		2	355 (180)	✿ <sup>e</sup>	30	
Cookies, Piped cookies	Baking sheet	2	320 - 340 (160 - 170)	✿	15	

\* Pre-heat the appliance to the specified temperature. When putting in the food to be cooked, switch back to the second specified temperature.

Dish	Accessories	Level	Temperature in ° F (°C)	Type of heating	Cooking time in min.	Observations
Filled puff pastry items	Baking sheet + parchment paper	3	390 (200)	✿	15	Recipe tip: Fill with ham and cheese or apples and raisins. Brush with egg yolk.
Puff pastry	Baking sheet + parchment paper	2	390 (200)	✿	10	Recipe tip: with sesame seed, poppy, sugar topping.
Puff pastry slices	Baking sheet + parchment paper	2	390 (200)	✿	15	Recipe tip: with pudding, fruit.
Hippengebäck cookies	Baking sheet + parchment paper	2	285 (140)	✿	10 - 15	The baking time depends on how thick the cookies are. Shape the dough while it is still hot, e.g. into horns or rolls for dessert.
Breadsticks	Baking sheet + parchment paper	2	320 (160)	✿	30 - 40	Sprinkle with sea salt, rosemary, curry powder, sesame seeds or caraway seeds. The baking time depends on how thick the breadsticks are.
Cookies, 0.7 oz each (20 g each)	Baking sheet + parchment paper	2	345 (175)	✿	10 - 12	With chocolate, raisins, nuts, or lemon.
Brownies	Baking sheet + parchment paper	2	250 (120)	✿	60 - 65	After baking, cut into squares. The low temperature means that the brownies retain a slightly sticky consistency in the middle.
		2	355 (180)	✿ <sup>e</sup>	45	No need to preheat; do not open appliance door.
Muffins	Muffin pan/ paper cases	2	355 (180)	✿	20	With chocolate, nuts, or raisins. Grease the muffin pan well.
Cupcakes	Cupcake pan/ paper cases	2	355 (180)	✿	15	Grease the cupcake pan well.
Small cakes (according to EN 60350-1)	Baking sheet	2	300 (150)	✿	25 - 35	Pre-heat
	Baking sheet	3	300 (150)	✿	28 - 32	Pre-heat
	Grill tray	1				Application on two levels
	Baking sheet	2	320 (160)	---	28 - 32	Pre-heat
Piped cookies (according to EN 60350-1)	Baking sheet	2	285 (140)	✿	40 - 50	Pre-heat
	Baking sheet	3	285 (140)	✿	50 - 60	Pre-heat
	Grill tray	1				Application on two levels
	Baking sheet	2	320 (160)	---	30 - 35	Pre-heat

\* Pre-heat the appliance to the specified temperature. When putting in the food to be cooked, switch back to the second specified temperature.



Dish	Accessories	Level	Temperature in ° F (°C)	Type of heating	Cooking time in min.	Observations
<b>Bread, rolls</b>						
Multi-grain bread	Baking sheet + parchment paper	2	390 - 340* (200 / 170*)	☛	50 - 60	
Sourdough bread	Baking sheet + parchment paper	2	390 - 355* (200 / 180*)	---	50 - 60	
Bread, in loaf pan	Loaf pan + wire rack	2	345 (175)	---	45 - 50	
Baguette, pre-baked	Baking sheet + parchment paper	2	430 (220)	---	10 - 12	
Flatbread	Baking sheet + parchment paper	2	390 (200)	☛	25 - 30	The cooking time depends on the size and thickness of the flatbread.
Foccacia	Baking sheet + parchment paper	2	410 (210)	---	20 - 25	Top with various ingredients, e.g. herbs, sea salt, olives, anchovies, onions, ham, tomatoes, or cheese.
Garlic/herb baguette	Baking sheet + parchment paper	2	390 (200)	---	12 - 14	
Challah	Baking sheet + parchment paper	2	330 (165)	☛	25	No need to preheat; do not open appliance door.
		2	330 (165)	☛ <sup>e</sup>	45	
Rolls, frozen	Baking sheet + parchment paper	2	340 (170)	☛	12	
Rolls, fresh, 1.8 oz each (50 g each)	Baking sheet + parchment paper	2	480 - 390* (250 / 200*)	---	20 - 25	
Pretzel products, frozen	Baking sheet + parchment paper	2	390 (200)	☛	12 - 15	
Croissants, frozen	Baking sheet + parchment paper	2	340 (170)	---	25 - 30	

\* Pre-heat the appliance to the specified temperature. When putting in the food to be cooked, switch back to the second specified temperature.







## Dough proving (leaving to rise)

- Place the bowl containing the dough onto the wire rack. Select the "Dough proving" heating function.
- For large quantities, e.g. of bread, set the temperature to 100 - 104° F (38 - 40 °C) and extend the time. This helps the dough to rise evenly from the center to the edges.
- For small quantities of dough, for noodles or rolls, you can set the temperature to 104 - 113° F (40 - 45 °C).
- The suggested cooking time is only a guideline. Let the dough rise until its volume has doubled.
- If the dough does not rise, you have used too little yeast or not kneaded the dough enough.
- With this heating function, the interior lighting remains switched off.

Dish	Accessories	Level	Temperature in °F (°C)	Type of heating	Cooking time in min.	Observations
Dough	Bowl + wire rack	2	100- 115 (38 - 45)		25 - 45	e.g. yeast dough, natural fermentation starter, sourdough, dumplings

## Desserts

- Oven-cooked desserts are very easy to prepare – you just have to put it in the oven. This preparation method is well-suited for larger quantities, for example if you have guests.
- Oven-cooked desserts are generally eaten warm, and are particularly enjoyable during the cooler months.

Dish	Accessories	Level	Temperature in °F (°C)	Type of heating	Cooking time in min.	Observations
Apple Crumble	Ovenproof dish + wire rack	2	390 (200)		25	Apple bake with a crumble topping; equally delicious with berries or mirabelles.
Baked apples	Ovenproof dish + wire rack	2	390 (200)		30	Recommendation: Use cooking apples, e.g. Boskop. These are particularly well suited for cooking and baking. Summer variant: fill with ricotta, lemon, honey, cardamom, vanilla, and pine nuts.
Compote	Grill tray	2	355 (180)		30 - 40	e.g. apricots or assorted berries Do not add any liquid, stir several times. Season with honey, fresh vanilla or cinnamon. The cooking time depends on the type and ripeness of the fruit.
Clafouti	Ovenproof dish + wire rack	2	390 (200)		30	French dessert: classic with cherries, also tastes very good when made with berries or mirabelles.
		2	390 (200)		55	No need to preheat; do not open appliance door.
Sweet bake	Ovenproof dish + wire rack	2	355 (180)		30	e.g. semolina, quark, or rice pudding
Meringue, 0.7 oz (20 g)	Baking tray + grease-proof paper	2	210 (100)		150	When dividing up the mixture, make sure that the portions are spread as thinly as possible so that the mixture dries out well.

## Defrosting

- For this, use the "defrost" heating function.
- The defrosting times specified are intended as a guide only. The defrosting time depends on the size, weight, and shape of the food to be defrosted; freeze your foods flat or individually. This reduces the defrosting time.
- Slide the wire rack with the frozen food in at the second rack level. Slide the grill tray underneath to catch any liquid that drips down as the food defrosts.
- Remove the food from the packaging before defrosting.
- Only defrost the quantity that you need right away.
- Remember: Once defrosted, food may not keep for as long and spoils faster than fresh food. Prepare defrosted food immediately and cook it thoroughly.
- After half the defrosting time has elapsed, turn the meat or fish. Break up frozen clumps of food comprising many pieces, e.g. berries and pieces of meat. Fish does not need to be fully defrosted; it is sufficient to defrost it until the surface is soft enough for seasoning/spices to stick. Then leave the fish to finish defrosting at room temperature.

- The oven is not suitable for defrosting whole chickens or roasts as this takes a very long time. Steam ovens and combination steam ovens can be used to defrost this kind of food much more quickly.
- With a temperature setting below 158° F (70 °C), the cooking compartment lighting remains switched off.

### WARNING

#### Health risk!

When defrosting food from animal sources, you must remove the liquid that escapes during defrosting. It must never come into contact with other food. Bacteria could be transferred.

Slide the glass dish/grill tray under the food and into the appliance. Pour away the liquid that collects in the dish or tray as the meat and poultry defrosts. Then clean the sink and rinse with plenty of water. Clean the grill tray in hot soapy water or in the dishwasher.

After defrosting, operate the oven for 15 minutes using Hot air at 356° F (180 °C).

Dish	Accessories	Level	Temperature in °F (°C)	Type of heating	Cooking time in min.	Observations
Berries, 17.6 oz (500 g)	Grill tray	2	120 - 130 (50 - 55)	* ◊	25 - 30	
Vegetables, 17.6 oz (500 g)	Grill tray	2	130 (55)	* ◊	30 - 50	The defrosting time depends on the portions. Small vegetables, such as peas and beans, defrost more quickly than blocks of spinach or cauliflower florets.
Chicken legs, 7.1 oz (200 g each)	Wire rack + grill tray	2	130 (55)	* ◊	50 - 55*	
Fish fillet, 5.3 oz (150 g each)	Wire rack + grill tray	2	115 - 120 (45 - 50)	* ◊	45 - 50*	
Shrimp	Wire rack + grill tray	2	120 (50)	* ◊	25	

\* Add a balancing time: Once the defrosting time has elapsed, switch off the appliance and leave the food to rest in the appliance for a further 10 - 15 minutes with the door closed so that it has a chance to defrost right through to the very centre.

## Preserving

- If possible, cook food immediately after purchase or harvesting. Longer storage decreases the vitamin content and can cause spoilage.
- Only use fruit and vegetables in good condition.
- The oven is not suited for preserving meat.
- Check and clean the canning jars, rubber rings, clamps, and springs carefully.
- Place the canning jars in a heat-resistant container with water. Make sure that they do not touch. The water level must reach at least three quarters of the way up to the top of the contents of the jars.
- Open the cooking compartment door after the cooking time has elapsed. Do not remove the canning jars from the cooking compartment until they have cooled down completely.
- Store the preserves in a cool, dark and dry place, e.g. in a pantry. Once the jars have been opened, use the contents up quickly and store in the refrigerator.

Dish	Accessories	Level	Temperature in °F (°C)	Type of heating	Cooking time in min.	Observations
Fruit	Wire rack	1	300 - 320 (150 - 160)	---	35 - 40	in closed canning jars
Vegetables	Wire rack	1	375 - 390 (190 - 200)	---	60 - 120	in closed canning jars

## Disinfecting

- Before you begin canning, the glasses should be disinfected in the oven to prevent the food from spoiling. This is the only way to ensure that canned goods keep for a relatively long time and can be stored outside of the refrigerator.
- Disinfect the empty jars at 210° F (100 °C) for at least 20 minutes using the "Hot air" (fan-oven) setting. The lids and rubber preserving seals for the jars can be disinfected at the same time in boiling water to avoid them drying out in the dry heat of the oven.

Dish	Accessories	Level	Temperature in °F (°C)	Type of heating	Cooking time in min.	Observations
Disinfecting	Wire rack	2	210 (100)	✚	20 - 25	Canning jars, baby bottles

## Drying

- Drying is a method of preserving food in which up to 50% of the moisture contained in the food is removed by exposing it to dry heat. This also makes the flavor more intense.
- The thicker the food, the longer the drying process takes. The quickest way to dry food – which is also the method that saves the most energy – is to cut it into slices.
- Place the prepared food onto a wire rack or baking tray covered with parchment paper. During the drying process, turn the food every now and then.
- The duration depends on the thickness of the food and on the natural level of moisture in the food, i.e. tomatoes take longer to dry out than mushrooms.
- If you want to dry food in the oven on two levels at the same time, use levels 1 and 3.



Dish	Accessories	Level	Temperature in °F (°C)	Type of heating	Cooking time in hours	Observations
Sliced mushrooms	Wire rack + parchment paper	2	140 (60)	☼	3 - 4	
Apple rings	Wire rack + parchment paper	2	160 (70)	☼	6 - 8	
Tomatoes in eighths	Wire rack + parchment paper	2	160 (70)	☼	7 - 8	Remove the core from the tomatoes; otherwise the drying time is longer.
Herbs	Wire rack + parchment paper	2	140 (60)	☼	1:30 - 2	e.g. chives, parsley, sage

## Baking stone

- You will need a baking stone and heating element – these are optional accessories.
- Whether you are baking crispy pizza or fresh bread, with the baking stone, you will achieve results that are comparable to, or even exceed, those that you would get from a massive stone oven because you are able to precisely control the baking temperature.
- Depending on the size, you can also place several pizzas, rolls or other baked goods on the baking stone at the same time.
- You can bake several pizzas in succession. This may increase the baking time per pizza by approx. 1 - 3 minutes.
- When baking bread, we recommend that you use the core temperature sensor. Wait 10 - 15 minutes after baking has begun before inserting the core temperature sensor into the thickest part of the bread. The sensor measures the internal temperature of the baked goods and switches the oven off when the set core temperature has been reached.
- When dough is baked, it needs to be able to expand without the surface breaking apart. This can be achieved by pricking it several times with a fork or by making a cut with a knife.
- The temperatures and times given in the cooking table are guideline values. Always follow the manufacturer's instructions for pre-cooked and frozen products.

Dish	Accessories	Level	Temperature in °F (°C)	Type of heating	Cooking time in min.	Observations
Rolls, fresh (1.8 oz (50 g) each)	Baking stone	1	480 / 390* (250 / 200*)	☼	15 - 20	
Flatbread	Baking stone	1	410 (210)	☼	20 - 25	Cooking time depends on the size and thickness of the flatbread
Focaccia	Baking stone	1	410 (210)	☼	20	Top with various ingredients, e.g. herbs, sea salt, olives, anchovies, onions, ham, tomatoes, or cheese.
Multi-grain bread	Baking stone	1	390 (200)	☼	35 - 45	
Sourdough bread	Baking stone	1	480 / 390* (250 / 200*)	☼	50 - 60	
Pizza, fresh	Baking stone	1	525 (275)	☼	5 - 8	The cooking time varies depending on the type and thickness of the dough and topping.



\* Pre-heat the appliance to the specified temperature. Turn the temperature down when placing the food in the oven.

Dish	Accessories	Level	Temperature in °F (°C)	Type of heating	Cooking time in min.	Observations
Pizza, frozen	Baking stone	1	445 (230)		8 - 10	The cooking time varies depending on the thickness of the dough. Observe the manufacturer's instructions.
Tarte flambée, fresh	Baking stone	1	570 (300)		2 - 4	Recipe tip: classic or with fresh goat's cheese, Parma ham, figs, and spring onions.
Tarte flambée, frozen	Baking stone	1	480 (250)		8 - 10	

\* Pre-heat the appliance to the specified temperature. Turn the temperature down when placing the food in the oven.

## Roasting dish

- You will need a roaster, pull-out system and heating element – these are optional accessories.
- In the roasting dish, you can also braise large pieces of meat easily and cook large quantities.
- Food is easy to prepare and can be kept warm in the oven. Your kitchen will look clean and tidy, the cooktop will not be dirty, and there will be fewer cooking odors because the dish was cooked in the oven.
- The non-stick coating enables you to roast using very little fat.  
Tip: Instead of adding the fat to the roasting dish, oil the meat. This ensures that the heat is transferred directly to the meat.
- Cooking liquids reduce down quickly. Make sure there is always sufficient cooking liquid. For a cooking time of 30 minutes, add approx. ½ l liquid.
- When roasting in a sauce, always ensure the sauce remains runny and add cooking liquid.
- In addition, follow the instructions in the instruction manual for the roasting dish.

Dish	Accessories	Level	Temperature in °F (°C)	Type of heating	Cooking time in min.	Observations
Chicken breast	Roasting dish	1	390 (200)		Searing + 15 - 20	Use the core temperature sensor. Do not cover.
Beef goulash	Roasting dish	1	430 / 265* (220 / 130*)		Searing + 60 - 90	Sear onions and meat; use the roasting setting for this. Pour in liquid and turn the temperature back down; cook for 60 - 90 minutes, depending on the type of meat. Cover with the lid.
Ossobuco	Roasting dish	1	430 / 285* (220 / 140*)		Searing + 60 - 90	Sear meat and vegetables; use the roasting setting for this. Pour in liquid and turn heat down, cook covered for 60 - 90 minutes. Turn the sliced shanks once. Cover with the lid.

\*\* Brown the meat at high temperature, turn the temperature back down to continue cooking.

Dish	Accessories	Level	Temperature in °F (°C)	Type of heating	Cooking time in min.	Observations
Viennese boiled beef	Roasting dish	1	430 / 265* (220 / 130*)	<input type="checkbox"/>	Searing + 200 - 220	Sear the onion halves, add the vegetables and roast briefly, then fill the dish with liquid. Bring to a boil, season, and add beef. The meat should be completely covered with liquid. Put roasting lid on and continue cooking at 265° F (130 °C). Cover with the lid.
Roulades	Roasting dish	1	430 / 250* (220 / 120*)	<input type="checkbox"/>	Searing + 60 - 80	Sear roulades in portions; use the roasting setting for this. Cover with the lid.
Tortillas	Roasting dish	1	345 (175)	<input type="checkbox"/>	Searing + 10 - 15	Sear all ingredients apart from eggs in the roasting dish, then pour the eggs over the top and continue cooking until the tortilla is firm. Cover with the lid.
Farmers' omelette	Roasting dish	1	345 (175)	<input type="checkbox"/>	Searing + 10 - 15	Sear all ingredients apart from the eggs in the roasting dish, then pour the eggs over the top and continue cooking until the farmers' omelette is firm. Cover with the lid.
Couscous dish	Roasting dish	1	430 / 285* (220 / 140*)	<input type="checkbox"/>	Searing + 90 - 120	Sear the meat and vegetables, then add the liquid and continue cooking. Cover with the lid. Prepare the couscous in a pan on the burner.
Chili con carne	Roasting dish	1	430 / 265* (220 / 130*)	<input type="checkbox"/>	Searing + 90	Cover with the lid.

\*\* Brown the meat at high temperature, turn the temperature back down to continue cooking.

## Acrylamide in foodstuffs

Which foods are affected?

Acrylamide is mainly produced in grain and potato products that are heated to high temperatures, such as chips, fries, toast, rolls, bread, fine baked goods (cookies, gingerbread, Christmas spice cookies).

### Tips for keeping acrylamide to a minimum when preparing food

**General** Keep cooking times as short as possible. Cook food until it is golden brown, but not too dark. Large, thick pieces of food contain less acrylamide.

**Baking** With hot air at max. 355° F (180 °C).

### Tips for keeping acrylamide to a minimum when preparing food

Cookies	Egg or egg yolk reduces the production of acrylamide. Spread out a single layer evenly on the baking tray.
Oven French fries	Cook at least 7 oz (400 g) at once on a baking tray so that the fries do not dry out.

Gaggenau  
BSH Home Appliance Corporation  
1901 Main Street, Suite 600  
Irvine, CA 92614  
1-877-442-4436

[www.gaggenau.com/us](http://www.gaggenau.com/us)  
© 2021 BSH Home Appliances

Gaggenau Hausgeräte GmbH  
Carl-Wery-Straße 34  
81739 München  
GERMANY



**GAGGENAU**