

Gaggenau

Use and care manual

BX 480/481 612

Double oven

Table of Contents

▲ Safety Definitions	3	Timer functions	19
IMPORTANT SAFETY INSTRUCTIONS	4	Launching the timer menu	19
Proper Installation and Maintenance	4	Timer	19
Fire Safety	5	Stopwatch	19
Burn Prevention	6	Cooking time	20
Child Safety	7	End of cooking time	21
Cleaning Safety	7	Set time functions for both ovens simultaneously	21
Cookware Safety	7	Sabbath mode and Yom Tov mode	22
Proposition 65 Warning	8	Sabbath mode	22
Causes of damage	9	Yom Tov mode	23
Environmental protection	9	Core temperature probe	24
Tips for saving energy	9	Inserting the core temperature probe into the food	24
Familiarizing yourself with your appliance	10	Setting the core temperature	25
Oven	10	Core temperature guidelines	26
Displays and controls	11	Rotisserie spit	27
Symbols	11	Preparation	27
Colors and display	11	Turn on rotisserie spit	28
Standby	12	Switching off the rotisserie spit	28
Activate appliance	12	Roasting function	29
Additional information i and i [®]	12	Childproof lock	29
Cooling fan	12	Activating the child lock	29
Program selection positions	13	Deactivating the child lock	29
Accessories	14	Basic settings	30
Special accessories	15	Cleaning and maintenance	32
Before using the appliance for the first time	15	Cleaning agents	32
Setting the language	15	Removing the plug-in grid	33
Setting the time format	16	Pyrolysis (self-cleaning)	34
Setting the time	16	Preparing the pyrolytic self-cleaning feature	34
Setting the date format	16	Starting the pyrolytic self-cleaning function	35
Setting the date	16	Set self-clean (pyrolysis) for both ovens	35
Setting the temperature unit	16	Cleaning the Accessories with the Pyrolytic Self-cleaning Feature	35
Completing initial set-up	17	Troubleshooting	36
Heating up the oven	17	Power cut	36
Cleaning accessories	17	Demo mode	36
Operating the appliance	17	Replacing the oven lamp	37
Oven interior	17		
Inserting the rack	17		
Setting the heating mode and the temperature	18		
Quick heat	18		
Safety shut-off	18		

Customer service	38
Tables and tips	38
Vegetables	39
Side dishes and dishes	40
Fish	43
Meat	43
Poultry	46
Grilling and roasting	47
Baked goods	49
Dough proving (leaving to rise)	54
Desserts	54
Defrosting	55
Preserving	56
Disinfecting	56
Drying	56
Baking stone	57
Roasting dish	58
Acrylamide in foodstuffs	59

Additional information on products, accessories, replacement parts and services can be found at www.gaggenau.com and in the online shop www.gaggenau.com/zz/store

Safety Definitions

WARNING

This indicates that death or serious injuries may occur as a result of non-observance of this warning.

CAUTION

This indicates that minor or moderate injuries may occur as a result of non-observance of this warning.

NOTICE

This indicates that damage to the appliance or property may occur as a result of non-compliance with this advisory.

Note: This alerts you to important information and/or tips.

IMPORTANT SAFETY INSTRUCTIONS

READ AND SAVE THESE INSTRUCTIONS

WARNING

When properly cared for, your new appliance has been designed to be safe and reliable. Read all instructions carefully before use. These precautions will reduce the risk of burns, electric shock, fire, and injury to persons. When using kitchen appliances, basic safety precautions must be followed, including those in the following pages.

Proper Installation and Maintenance

Have the installer show you the location of the circuit breaker or fuse. Mark it for easy reference.

This appliance must be properly installed and grounded by a qualified technician. Connect only to properly grounded outlet. Refer to Installation Instructions for details.

This appliance is intended for normal family household use only. It is not approved for outdoor use. See the Statement of Limited Product Warranty. If you have any questions, contact the manufacturer.

Do not store or use corrosive chemicals, vapors, flammables or nonfood products in or near this appliance. It is specifically designed for use when heating or cooking food. The use of corrosive chemicals in heating or cleaning will damage the appliance and could result in injury.

Do not operate this appliance if it is not working properly, or if it has been damaged. Contact an authorized servicer.

Do not obstruct oven vents.

Do not repair or replace any part of the appliance unless specifically recommended in this manual. Refer all servicing to an authorized servicer.

WARNING

Risk of burns!

To avoid risk of injury, turn off the interior light before cleaning the oven to allow the bulbs to cool down. The bulbs can become very hot when switched on. Keep the light off while cleaning the oven.

WARNING

Make sure the appliance and lights are cool and power to the appliance has been turned off before replacing the light bulb(s). Failure to do so could result in electrical shock or burns. The lenses (if equipped) must be in place when using the appliance. The lenses (if equipped) serve to protect the light bulb from breaking. The lenses (if equipped) are made of glass. Handle carefully to avoid breaking. Broken glass can cause an injury.

IMPORTANT SAFETY INSTRUCTIONS

READ AND SAVE THESE INSTRUCTIONS

WARNING

Light socket is live when door is open if main power supply is not turned off.

Fire Safety

WARNING

NEVER cover any slots, holes or passages in the oven bottom or cover an entire rack with materials such as aluminum foil. Doing so blocks air flow through the oven. Aluminum foil linings may also trap heat, causing a fire hazard.

If materials inside an oven or warming drawer should ignite, keep door closed. Turn off the appliance and disconnect the circuit at the circuit breaker box.

WARNING

Use this appliance only for its intended use as described in this manual. NEVER use this appliance as a space heater to heat or warm the room. Doing so may result in overheating the appliance. Never use the appliance for storage.

Always have a working smoke detector near the kitchen.

In the event that personal clothing or hair catches fire, drop and roll immediately to extinguish flames.

Have an appropriate fire extinguisher available, nearby, highly visible and easily accessible near the appliance.

Smother flames from food fires other than grease fires with baking soda. Never use water on cooking fires.

WARNING

TO REDUCE THE RISK OF INJURY TO PERSONS IN THE EVENT OF A GREASE FIRE, OBSERVE THE FOLLOWING:

1. **SMOTHER FLAMES** with a close-fitting lid, cookie sheet, or metal tray, then turn off the burner. **BE CAREFUL TO PREVENT BURNS.** If the flames do not go out immediately, **EVACUATE AND CALL THE FIRE DEPARTMENT.**
 2. **NEVER PICK UP A FLAMING PAN** – You may be burned.
 3. **DO NOT USE WATER**, including wet dishcloths or towels – a violent steam explosion will result.
 4. Use an extinguisher **ONLY** if:
 - You know you have a Class ABC extinguisher, and you already know how to operate it.
 - The fire is small and contained in the area where it started.
 - The fire department is being called.
 - You can fight the fire with your back to an exit.
-



IMPORTANT SAFETY INSTRUCTIONS

READ AND SAVE THESE INSTRUCTIONS

Burn Prevention

DO NOT TOUCH HEATING ELEMENTS OR INTERIOR SURFACES OF OVEN - Heating elements may be hot even though they are dark in color. Interior surfaces of an oven become hot enough to cause burns. During and after use, do not touch, or let clothing, potholders, or other flammable materials contact heating elements or interior surfaces of oven until they have had sufficient time to cool. Other surfaces of the appliance may become hot enough to cause burns. Among these surfaces are oven vent openings, surfaces near these openings and oven doors.

Exercise caution when opening the appliance. Standing to the side, open the door (or drawer) slowly and slightly to let hot air and/or steam escape. Keep your face clear of the opening and make sure there are no children or pets near the unit. After the release of hot air and/or steam, proceed with your cooking. Keep doors shut unless necessary for cooking or cleaning purposes. Do not leave open doors unattended.



WARNING

Risk of burns!

The inside of the appliance door becomes very hot during operation. Always open the appliance door as far as it will go. Ensure that the appliance door does not swing back. Avoid contact with the inside of the appliance door.

Do not heat or warm unopened food containers. Build-up of pressure may cause the container to burst and cause injury.

Use caution when cooking foods with high alcohol content (e.g. rum, brandy, bourbon) in the oven. Alcohol evaporates at high temperatures. There is a risk of burning as the alcohol vapors may catch fire in the oven. Use only small quantities of alcohol in foods, and open the oven door carefully.

Always place oven racks in desired location while oven is cool. Always use oven mitts, when the oven is warm. If a rack must be moved while oven is hot, do not let potholder contact the heating elements.



CAUTION

To avoid possible injury or damage to the appliance, ensure rack is installed exactly per installation instructions and not backwards or upside down.

Always use dry potholders. Moist or damp potholders on hot surfaces may result in burns from steam. Do not let potholder touch hot heating elements. Do not use a towel or other bulky cloth.

Secure all loose garments, etc. before beginning. Tie long hair so that it does not hang loose, and do not wear loose fitting clothing or hanging garments, such as ties, scarves, jewelry, or dangling sleeves.



IMPORTANT SAFETY INSTRUCTIONS

READ AND SAVE THESE INSTRUCTIONS

Child Safety

When children become old enough to use the appliance, it is the responsibility of the parents or legal guardians to ensure that they are instructed in safe practices by qualified persons.

Do not allow anyone to climb, stand, lean, sit, or hang on any part of an appliance, especially a door, warming drawer, or storage drawer. This can damage the appliance, and the unit may tip over, potentially causing severe injury.

Do not allow children to use this appliance unless closely supervised by an adult. Children and pets should not be left alone or unattended in the area where the appliance is in use. They should never be allowed to play in its vicinity, whether or not the appliance is in use.



CAUTION

Items of interest to children should not be stored in an appliance, in cabinets above an appliance or on the backsplash. Children climbing on an appliance to reach items could be seriously injured.

Cleaning Safety

IMPORTANT SAFETY NOTICE: The California Safe Drinking Water and Toxic Enforcement Act requires the Governor of California to publish a list of substances known to the state to cause cancer, birth defects or other reproductive harm, and requires businesses to warn customers of potential exposure to such substances.

The burning of gas cooking fuel and the elimination of soil during self-cleaning can generate some by-products which are on the list. To minimize exposure to these substances, always operate this unit according to the instructions contained in this booklet and provide good ventilation.

When self-cleaning, confirm that the door locks and will not open. If the door does not lock, do not run Self-Clean. Contact service.

Wipe out excessive spillage before self-cleaning the oven.

Birds have very sensitive respiratory systems. Keep pet birds out of the kitchen or other rooms where kitchen fumes could reach them. During self-clean, fumes are released that may be harmful to birds. Other kitchen fumes such as overheating margarines and cooking oils may also be harmful.

Keep oven free from grease build up.

Cookware Safety

NOTICE

Do not place food directly on oven bottom.

Follow the manufacturer's directions when using cooking or roasting bags.



CAUTION

Do not leave food or cooking utensils, etc., in the oven during the self-cleaning mode of operation.

IMPORTANT SAFETY INSTRUCTIONS

READ AND SAVE THESE INSTRUCTIONS

Do not clean parts or accessories in the self-clean oven.

WARNING

Risk of electric shock!

Use of a wrong core temperature probe can damage the insulation.

Use only the core temperature probe intended for this appliance.

Proposition 65 Warning:

This product may contain a chemical known to the State of California, which can cause cancer or reproductive harm. Therefore, the packaging of your product may bear the following label as required by California:

STATE OF CALIFORNIA PROPOSITION 65 WARNING:

 **WARNING**

Cancer and Reproductive Harm - www.P65Warnings.ca.gov

Causes of damage

NOTICES:

- Accessories, foil, baking paper or cookware on the bottom of the oven interior: do not place any accessories on the bottom of the oven interior. Do not line the bottom of the oven interior with any type of foil or baking paper. Do not place cookware on the bottom of the oven interior when a temperature above 122°F (50 °C) is set. This produces a build-up of heat. Baking and roasting times are no longer correct and the enamel is damaged.
- Water in the hot oven interior: Never pour water into the hot oven interior. Steam is produced. Damage to the enamel can arise due to the temperature change.
- Do not leave moist groceries in a closed oven for an extended period of time. It can lead to corrosion inside the oven.
- Fruit juice can leave stains in the oven. Always remove fruit juice immediately when safe to touch, and wipe up first with a damp and then a dry cloth.
- Cooling with the appliance door open: only allow the oven cavity to cool when it is closed. Even if the appliance door is only open a little, front panels of adjacent units could be damaged over time.
- Highly soiled door seal: the appliance door will no longer close properly during operation if the door seal is highly soiled. Adjoining furniture fronts may be damaged. Always keep the door seal clean.
- Appliance door as a seat or storage surface: do not stand, sit or hang on the appliance door. Do not place any cookware or accessories on the appliance door.
- Inserting accessories: depending on the appliance type, accessories can scratch the door pane when closing the appliance door. Always slide accessories fully into the oven interior.
- Do not hold or carry the appliance by the door handle. The door handle cannot carry the weight of the device and could break off.

Environmental protection

Unpack the appliance and dispose of the packaging in an environmentally friendly manner.

Tips for saving energy

- Open the appliance door as little as possible while cooking, baking or roasting.
- Use dark, black-painted or enameled baking forms. These absorb the heat particularly well.
- It is best to bake several cakes in succession. The oven is still warm. This shortens the baking time for the second cake. You can also slide in two loaf tins next to each other.
- In the hot air mode, you can bake simultaneously on several levels.
- For longer cooking times, you can switch off the oven 10 minutes before the end of the cooking time and you can use the residual heat to finish cooking.

Familiarizing yourself with your appliance

You will get to know your new appliance here. We explain the control panel and the individual controls to you. You are informed about the oven interior and accessories.

Oven

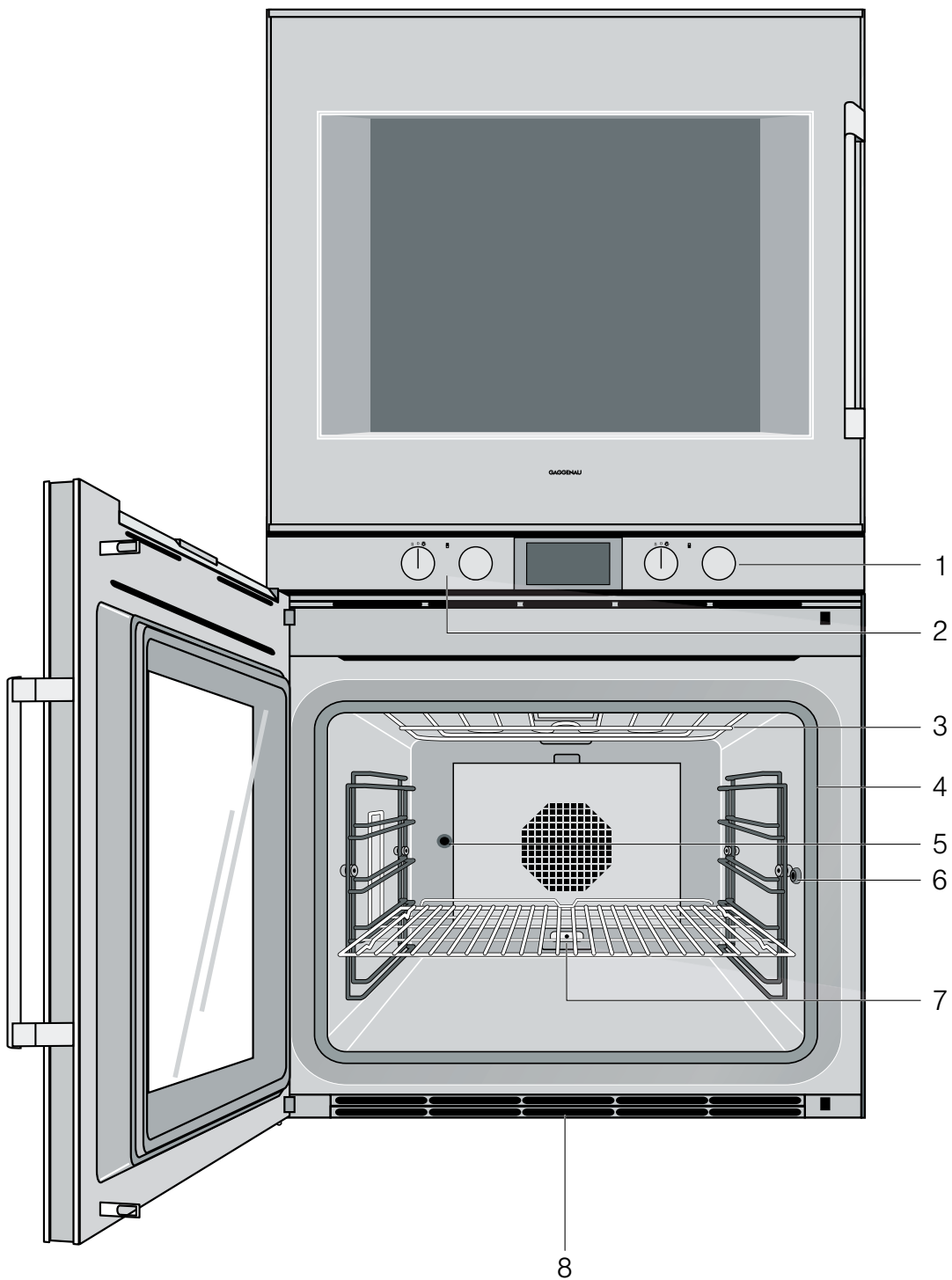



1	Operating elements upper oven
2	Operating elements lower oven
3	Grill heating element
4	Door seal
5	Rotisserie spit drive
6	Opening for core temperature probe
7	Opening for additional heating element (for the baking stone and roasting dish optional accessories)
8	Ventilation slots

NOTICE

Do not place food directly on oven bottom.

Do not obstruct oven vents.

Displays and controls





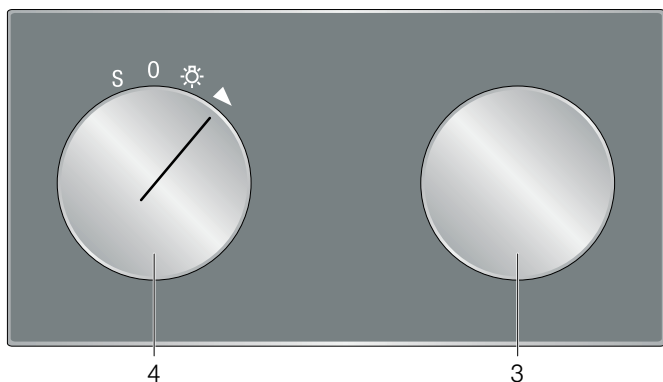
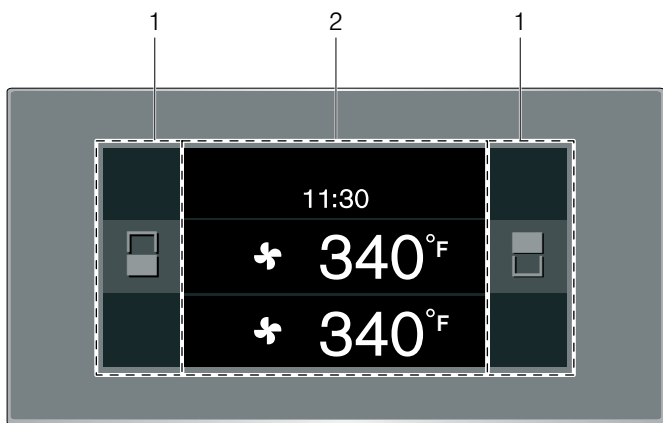

















Upper and lower oven use is identical. Select your preferred display for the upper oven , the lower oven , and both ovens . If you change a setting using the rotary or program selector, the screen will automatically display the information for the corresponding oven.

Rotisserie spit, core temperature probe, and roasting function are only available in the lower oven.



1	Control panel	These areas are touch-sensitive. Touch a symbol to select the applicable function.
2	Display	The display shows current settings and options, for example.
3	Rotary selector	With the rotary selector you can select the temperature and make other settings.
4	Program selector	With the program selector, you can select the heating function, the cleaning function or the basic settings.

Symbols

Symbol	Function
	Upper oven
	Lower oven
	Show settings of both ovens
	Start
	Stop
	Pause/end
	Cancel
	Delete
	Confirm/save settings
	Selection arrow
	Launching additional information
	Quick heating with status indicator
	Edit settings
	Child lock
	Launching the timer menu
	Launching the Sabbath mode
	Demo mode
	Core temperature probe
	Start rotisserie spit
	Stop rotisserie spit
	Start pre-roast stage
	End pre-roast stage

Colors and display

Colors

The various colors serve to guide you in the various adjustment situations.

Orange	First settings
	Main functions
Blue	Basic settings
	Cleaning
White	Adjustable values

Presentation

The presentation of symbols, values or the entire display changes depending on the situation.

Zoom	The display of the setting you are just changing is enlarged. Just before it elapses, a duration that is just elapsing is enlarged (e.g. the last 60 seconds in the case of timers).
Minimized display screen	After a short time, the display screen is minimized and only the most important things are displayed. This function is the default and can be modified in the basic settings.

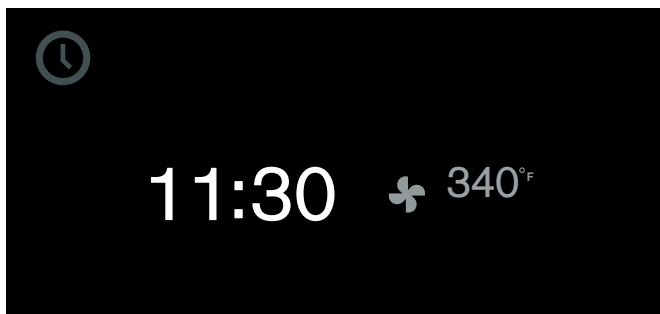

Standby

The appliance switches to standby mode if no function is set or the childproof lock is activated.

The brightness of the control panel is dimmed in standby mode.

Notes

- Different things can be displayed in standby mode. The default setting is the GAGGENAU logo and the time.
- The brightness of the display depends on the vertical viewing angle.
- You can change the display and the brightness at any time in the basic settings. → *"Basic settings" on page 30*

Activate appliance

In order to exit standby mode, you can either

- Set the function selector,
- Touch a control panel,
- or open or close the door.

Now you can set the desired function. Read the appropriate chapters to learn how to set functions.

Notes

- If "Standby screen = off" is selected in the factory setting, you must turn the function selector to exit the standby mode.
- The standby display appears again if you have not made any settings for a long while after activation.
- The cooking compartment lighting goes out after a little while if the door is open.

Additional information i and i[Ⓢ]

By touching the **i** symbol, you can call up additional information. For example, information on the heating function set or on the current temperature of the cooking compartment.

Note: During continuous operation, small fluctuations in temperature are normal after the oven has heated up.

The **i[Ⓢ]** symbol is displayed for important information and action prompts. Important information on safety and operation mode are occasionally shown automatically. These messages either disappear automatically after a few seconds or must be confirmed with **✓**.

Cooling fan

Your appliance has a cooling fan. The cooling fan switches on during operation. Depending on the appliance version, the warm air escapes above or under the door.

After removing cooked food, keep the door closed until the appliance cools down. The appliance door must not be left ajar, as adjoining kitchen furniture may be damaged. The cooling fan continues to run for a while and then switches off automatically.







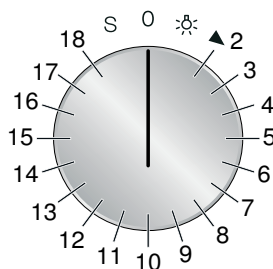



⚠ CAUTION

Do not cover up the ventilation slots. Otherwise, the appliance will become overheated.

Program selection positions



Position	Function/type of heating	Temperature	Application
0	Off position		
☼	Light		
2	☼ Convection	120 - 550°F (50 - 300°C) Default temperature 340°F (170°C)	Convection: For cakes, cookies and baked casseroles on several levels. The fan in the rear wall of the oven distributes the heat evenly throughout the oven cavity.
3	☼° Economy	120 - 550°F (50 - 300°C) Default temperature 340°F (170°C)	Energy-saving convection mode for cakes, meat, baked casseroles, and gratins. The convenience features (e.g. the oven lighting) remain off. The oven temperature can only be displayed while the oven is heating up. Do not preheat the oven. Place the food into the cold, empty oven cavity and start the stated cooking time. Keep the oven door closed during cooking to prevent heat escaping from the oven.
4	--- Top + bottom heat	120 - 550°F (50 - 300°C) Default temperature 340°F (170°C)	For cakes in pans or sheet cakes, baked casseroles, roasting.
5	--- Top + 1/3 bottom heat	120 - 550°F (50 - 300°C) Default temperature 340°F (170°C)	For sheet cakes, cookies, cakes with meringue, grilling, and baked casseroles with gratin. Very well-suited for a situation when the food should be heated from above toward the end of preparation.
6	--- Top heat	120 - 550°F (50 - 300°C) Default temperature 340°F (170°C)	Targeted heat from above, for example grilling cake topped with fruit and meringue.
7	--- 1/3 top + bottom heat	120 - 550°F (50 - 300°C) Default temperature 340°F (170°C)	For cheesecake, bread in loaf pans, dishes in a water bath (e.g. egg custard, crème brûlée). For roasting without a lid and warming up foods (foods dry out less). Very well-suited for a situation when the food should be heated from above toward the end of preparation.
8	--- Bottom heat	120 - 550°F (50 - 300°C) Default temperature 340°F (170°C)	For the final baking stage (such as for moist cakes topped with fruit), for preserving, for dishes in a water bath.
9	☼ Convection + bottom heat	120 - 550°F (50 - 300°C) Default temperature 340°F (170°C)	Additional heat from below for moist cakes, such as cake topped with fruit.
10	☼ Convection + 1/3 bottom heat	120 - 550°F (50 - 300°C) Default temperature 340°F (170°C)	For high baked casseroles, lasagne, onion tart, egg dishes (e.g. tortillas, farmers' omelettes).

Position	Function/type of heating	Temperature	Application
11	 Broil + circulated air	120 - 550°F (50 - 300°C) Default temperature 430°F (220°C)	Even, all-round heating for meat, poultry and whole fish.
12	 Broil	120 - 550°F (50 - 300°C) Default temperature 430°F (220°C)	To grill flat pieces of meat, sausages or fillets of fish. Cooking "au gratin."
13	 Economy broil	120 - 550°F (50 - 300°C) Default temperature 430°F (220°C)	Only the center part of the grill heating element is heated. Energy-saving grilling for small amounts.
14	 Baking stone function	120 - 550°F (50 - 300°C) Default temperature 480°F (250°C)	Can only be used with the baking stone and heating element (optional accessories). Baking stone heated from below for crisp stone-baked pizza, bread or rolls.
15	 Roaster function	120 - 430°F (50 - 220°C) Default temperature 360°F (180°C)	Can only be used with the roaster, pull-out system and heating element (optional accessories). Heatable cast iron roasting pan for large quantities of meat, baked casseroles or holiday roasts.
16	 Dough proofing	85 - 120°F (30 - 50°C) Default temperature 100°F (38°C)	Proofing: For yeast dough and sourdough. Dough will proof considerably more quickly than at room temperature. The optimal temperature setting for yeast dough is 100°F (38°C).
17	 Defrosting	100 - 140°F (40 - 60°C) Default temperature 115°F (45°C)	Even, gentle defrosting. For vegetables, meat, fish and fruit.
18	 Keeping warm	85 - 250°F (30 - 120°C) Default temperature 160°F (70°C)	Keeping food warm, pre-heating crockery.
S	 Basic settings		The basic settings of your appliance can be adjusted individually.
	 Pyrolytic cleaning	905°F (485°C)	Self-cleaning

Accessories

Use only the accessories included or obtainable from after-sales service. It has been specially adapted to your appliance. Make sure you always insert accessories into the interior the right way round.

Your appliance comes with the following accessories:

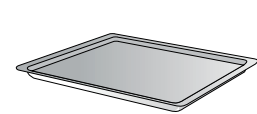

Baking tray, enameled



Wire grill tray



Grill tray with wire rack



Rotisserie spit

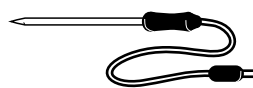

Plug-in core temperature probe

Special accessories

You can order the following accessories from your specialist dealer:

BA 018 165	Pull-out system Fully extendable telescopic pull-out rack and pyrolysis-proof cast frame
BA 028 115	Baking tray, enameled, 3¼" (30 mm) deep
BA 038 165	Wire rack, chrome-plated, with feet
BA 058 115	Heating element for baking stone and roaster
BA 058 133	Baking stone Including heating element and pizza paddle (order heating element separately)
BS 020 002	Pizza paddle, set of 2
GN 340 230	GN 2/3 cast aluminum roaster, height 6 1/2" (165 mm), non-stick (Order heating element and pull-out system separately)

Use the accessories only as indicated. The manufacturer assumes no liability for incorrect usage of the accessories.

Remove any accessories that are not required during operation from the cooking compartment. Bush for the additional heating element at the back of the cooking compartment: Always leave the cover in during normal operation without the additional heating element.

Before using the appliance for the first time

In this chapter, you can find out what you must do before using your oven to prepare food for the first time. Read the "Safety information" chapter beforehand.

The appliance must be completely installed and connected.

The "First settings" menu appears in the display after the mains has been connected. You can now set your new appliance:

- Language
- Time format
- Time
- Date format
- Date
- Temperature format

Notes

- The "Initial settings" menu will appear only after the appliance has been connected to a power supply and switched on for the first time, or if the appliance has not been connected to a power supply for a number of days.

Once the appliance has been connected to a power supply, the GAGGENAU logo will appear first for approximately 30 seconds. The "Initial settings" menu will then appear automatically.

- You can change the settings at any time in the basic settings. → "Basic settings" on page 30

Setting the language

The default language appears in the display.

1. Select the desired display language with the rotary selector.
2. Confirm with ✓.

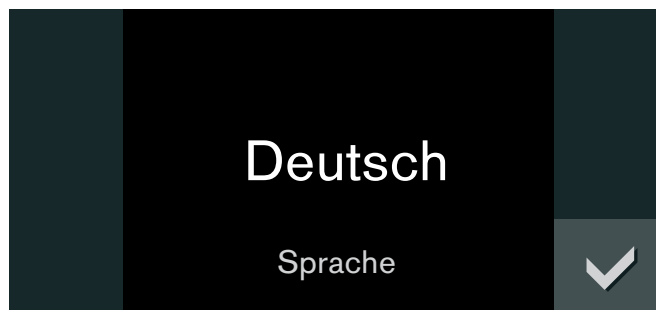

Note: If the language is changed, the system restarts. This takes a few seconds.

Setting the time format

the two possible formats 24h and AM/PM appear in the display. The default format is 24h.

1. Set the required format with the rotary selector.
2. Confirm with ✓.

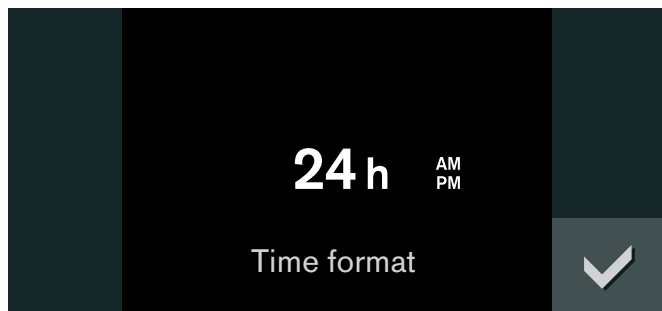

Setting the time

The time appears in the display.

1. Set the required time with the rotary selector.
2. Confirm with ✓.

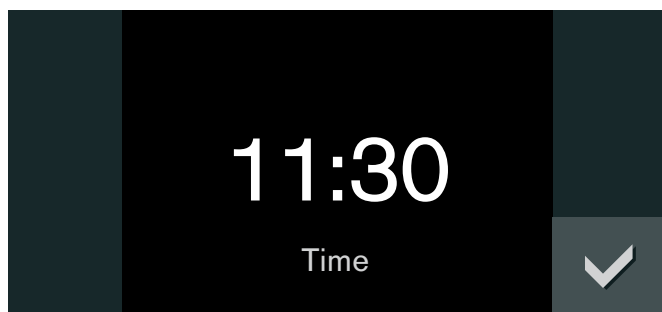

Setting the date format

The three possible formats D.M.Y, D/M/Y and M/D/Y appear in the display. The D.M.Y is the default.

1. Set the required format with the rotary selector.
2. Confirm with ✓.

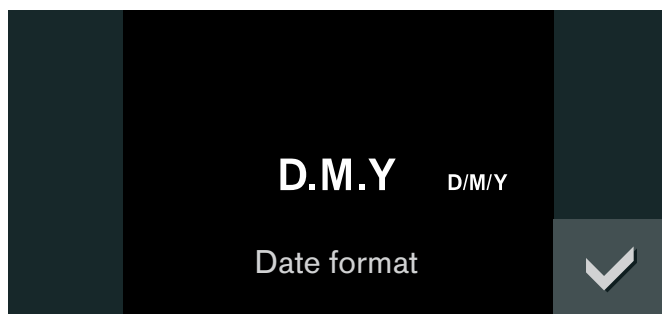

Setting the date

The default date appears in the display. The day setting is already active.

1. Set the required day with the rotary selector.
2. Switch to the month setting with the > symbol.
3. Set the month with the rotary selector.
4. Switch to the year setting with the > symbol.
5. Set the year with the rotary selector.
6. Confirm with ✓.

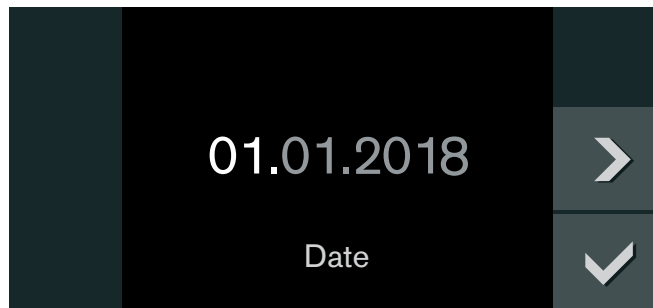

Setting the temperature unit

The two possible units °C and °F will appear on the display. The default unit is °C.

1. Use the rotary selector to select the unit you require.
2. Press ✓ to confirm.

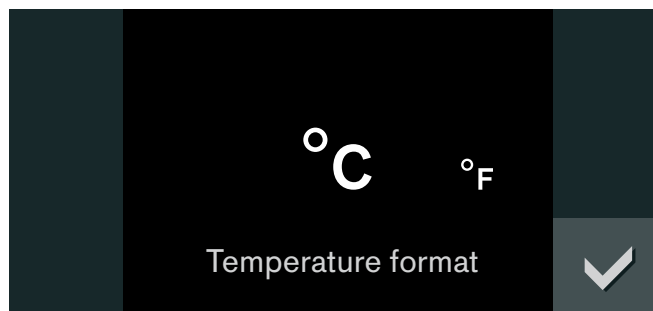

Completing initial set-up

"Initial set-up complete" appears in the display.

Confirm with ✓.

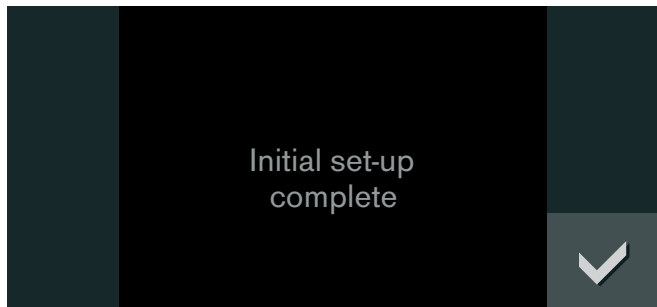

The appliance enters the standby mode and the standby display appears. The appliance is now ready for operation.

Heating up the oven

Make sure that there is no leftover packaging in the cooking compartment.

To eliminate the new-appliance smell, heat up the oven with it empty and the door closed. One hour with hot air  at 200 °C is ideal for this.

Cleaning accessories

Before using accessories for the first time, thoroughly clean them with hot soapy water and a soft dish cloth.

Operating the appliance

Oven interior

The cooking compartment has five shelf levels.

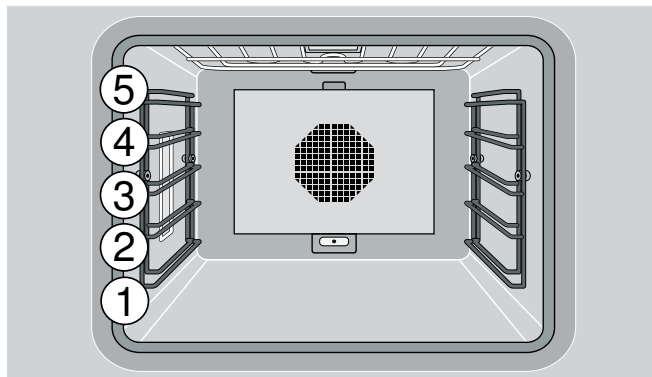

CAUTION

Do not place anything on the cooking compartment floor. Do not cover it with aluminium foil. A build-up of heat could damage the appliance or cause injury.



CAUTION

Do not slide any accessories between the shelf positions, or they may tip.

Inserting the rack

The accessories feature a rack stop function. The rack stop function prevents tilting of accessories when pulling them out. You must insert accessories in the oven interior correctly so that tilt protection will work.

Inserting the rack

1. Tilt the rack to guide the rack stop in between the rails of the rack holders . The rack stop has to face downwards.
2. Lower the rack and slide it into the oven, so that the rack stop can engage . Make sure the rack's safety rod is at the rear and top .

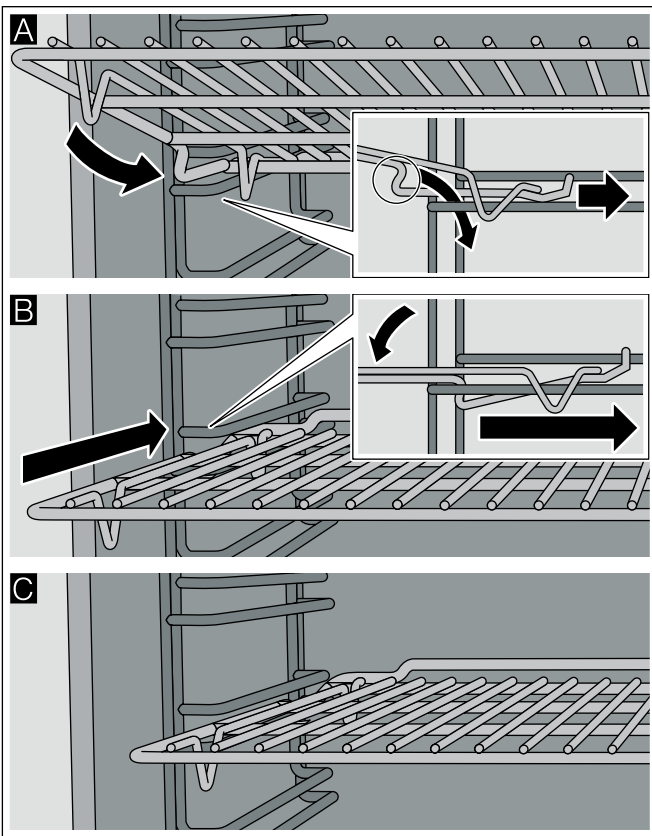

The pre-heat symbol $\hat{=}$ appears on the display. The bar shows the current pre-heat status. When the set temperature is reached, a signal sounds, the pre-heat symbol $\hat{=}$ goes out.

Note: With a temperature setting below 160° F (70° C), the cooking compartment lighting remains switched off.

If both ovens are switched on, the settings for both ovens appear on the display. Select the display of the appropriate oven with \blacksquare or \blacksquare ; use \blacksquare to return to the display of both ovens.

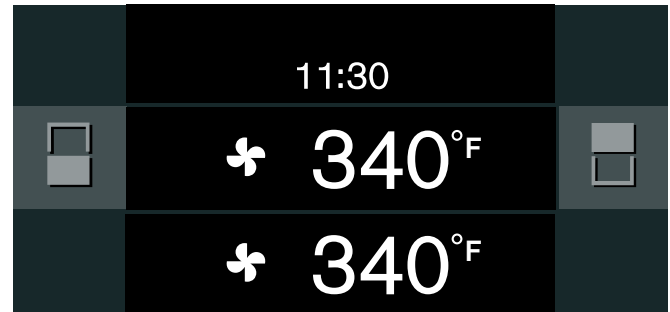

Switching off:
Set the function selector to 0.

Quick heat

With the "Quick heat" function, your appliance reaches the desired temperature particularly quickly in the top heat, bottom heat, and top/bottom heat types of heating.

To ensure an even cooking result, do not place your food in the cooking compartment until "Quick heat" is complete and the \gg heat-up symbol goes out.

Note: The "Quick heat" function is preset in the factory settings. In the basic settings, you can select \gg Quick heat or $\hat{=}$ Heat-up. → "Basic settings" on page 30

Safety shut-off

For your protection, the appliance has a safety shut-off feature. Every heating operation is switched off after 12 hours if the appliance is not operated during this time. A message appears in the display.

Exception:
programming with the long-term timer.

Turn the program selection to 0, after which you can operate the appliance in the manner to which you are accustomed.

Setting the heating mode and the temperature

You can operate both ovens simultaneously with different settings.

Exception: during self-cleaning in one oven, you cannot operate the second oven.

1. Use the function selector to set the type of heating.

Left function selector: lower oven

Right function selector: upper oven

The selected heating type and suggested temperature appear on the display.

Example: lower oven, convection, 340° F (170° C).

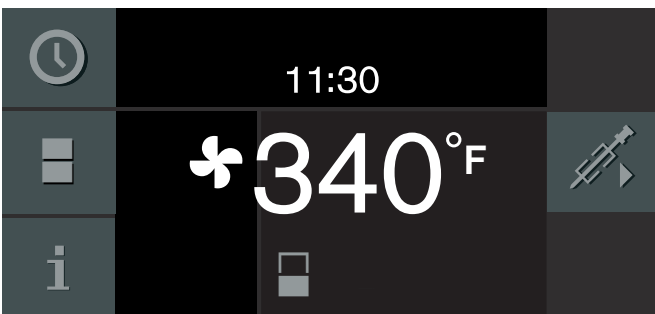

2. Turn the rotary selector to set the desired temperature.

Timer functions

In the timer menu, set:

- ⌚ Timer
- ⌚ Stopwatch
- 🕒 Cooking time (not in the idle state)
- 🕒 Cooking time end (not in the idle state)

The following chapters will outline how to set time functions for a single oven. If you would like to set the time function for both ovens simultaneously, please observe the additional information in → *"Set time functions for both ovens simultaneously"* on page 21

Launching the timer menu

You can launch the timer menu from any mode. Only from the factory settings, program selection is set to **S**, the time menu is not available.

Touch the ⌚ symbol.

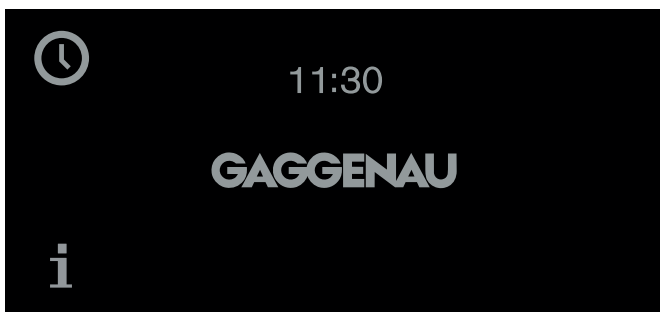

The timer menu appears.

Timer

The timer runs independently of the other appliance functions. You can enter a maximum of 90 minutes.

Setting the timer

1. Call up timer menu.
The "Timer" ⌚ function is displayed.
2. Turn the rotary selector to set the required cooking time.

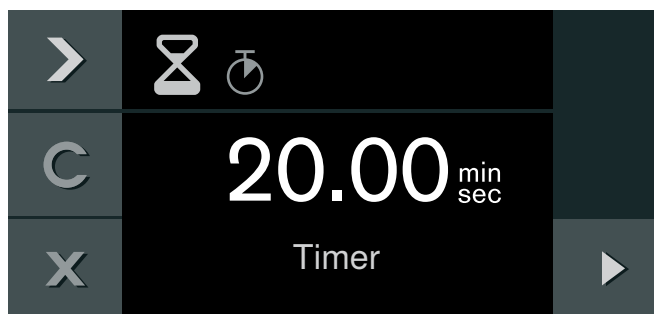

3. Start with ▶.

The timer menu closes and the time begins to count down. The ⌚ symbol and the countdown appear in the display.

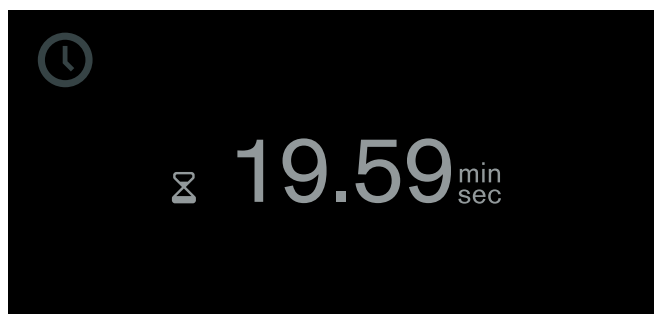

A signal sounds once the time has elapsed. Touch the ✓ symbol to silence.

You can exit the timer menu at any time by pressing the ✕ symbol. This erases the settings.

To stop the timer:

Call up timer menu. Touch ▶ to select the "Timer" ⌚ function and touch the || symbol. To allow the timer to continue counting down, touch the symbol ▶.

Switching off the timer early:

Call up timer menu. Touch ▶ to select the "Timer" ⌚ function and touch the C symbol.

Stopwatch

The stopwatch runs independently of the other appliance functions.

The stopwatch counts up from 0 seconds to 90 minutes.

It has a pause function. Therefore, you can stop the timer in between times.

Starting the stopwatch

1. Launching the timer menu.
2. With **>**, select the "Stopwatch" function **⌚**.

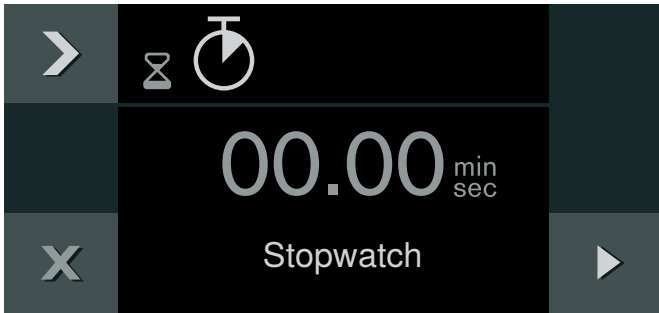

3. Start it with **▶**.

The timer menu is closed and the time runs. The **⌚** symbol and the elapsing timer are shown in the display.

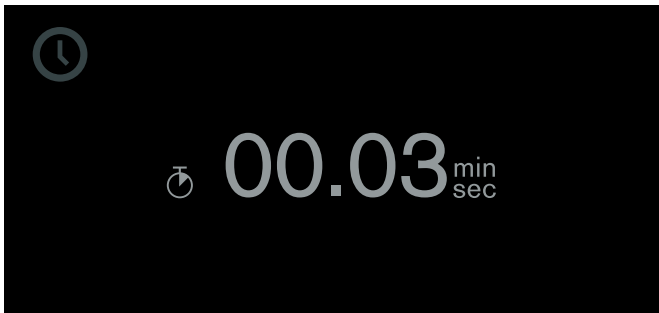

Stopping and restarting the stopwatch

1. Launch the timer menu.
2. With **>**, select the "Stopwatch" function **⌚**.
3. Touch the **||** symbol.

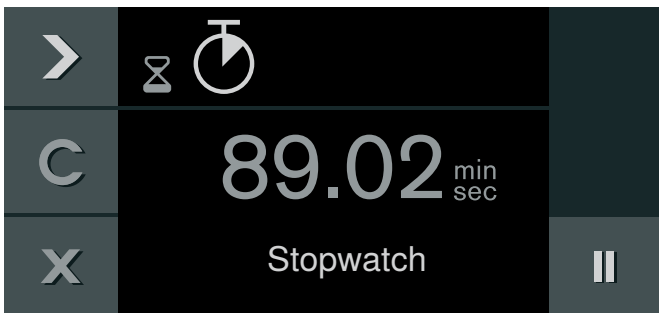

The time stops. The symbol changes to Start **▶** again.

4. Start with **▶**.

The time continues to run. Once 90 minutes have been reached, the display pulsates and a signal sounds. It goes off when you touch the **✓**. The **⌚** symbol disappears from the display. The operation has ended.

Switching off the stopwatch:

Launch the timer menu. With **>**, select the "Stopwatch" function **⌚** and touch the **C** symbol.

Cooking time

If you set a cooking time for your meal, the appliance switches off heating automatically after this time has elapsed.

You can set a cooking time from 1 minute to 23:59 hours.

Set cooking time

You have set the heat mode and the temperature and placed your food in the oven.

1. Touch the **⌚** symbol.
2. Using the **>** function, select **🕒** "cooking time".
3. Set the preferred cooking time with the rotary selector.



4. Start with **▶**.

The appliance will start. The timer menu will close. Temperature, mode, remaining time, and end of cooking time will appear on the screen.

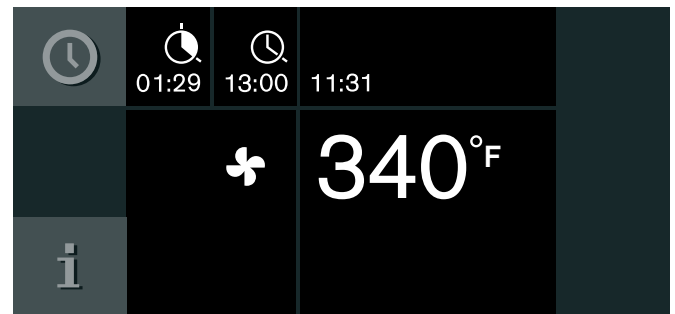

One minute before the end of cooking time, the remaining time will be magnified on the screen.

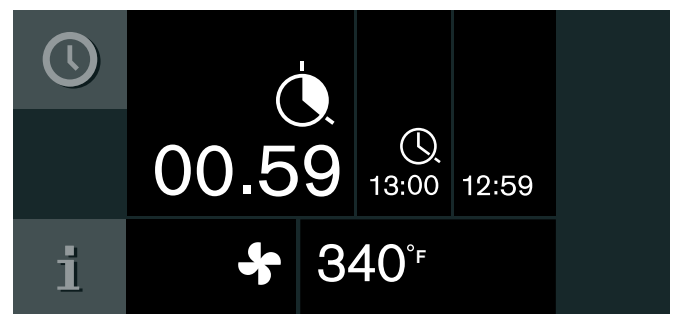

The appliance will turn off after the cooking time has ended. The **🕒** symbol will pulse and a signal will sound. It will stop when you touch the **✓** symbol, open the appliance door, or set the program selection to **0**.

Change cooking time:

Call up timer menu. Using the ➤ function, select 🕒 "cooking time". Change the cooking time using the rotary selector. Start with ▶.

Delete cooking time:

Call up timer menu. Using the ➤ function, select 🕒 "cooking time". Delete cooking time with C. Return to normal use with X.

Cancel complete process:

Set program selection to 0.

Note: You can also change temperature and heat mode during the cooking time.

End of cooking time

You can defer the end of the cooking time until later.

Example: it is 2 pm. The meal takes 40 minutes to cook. It should be ready by 3.30 pm.

Enter the cooking time and shift the end of the cooking time to 3.30 pm. The electronic circuitry calculates the starting time. The appliance starts automatically at 2:50 pm and switches off at 3.30 pm.

Note that easily perishable foodstuffs must not be left in the oven for too long.

Delay end of cooking time

You have set the heat mode, temperature, and cooking time.

1. Touch the 🕒 symbol.
2. Using the ➤, select 🕒 "end of cooking time".



3. Using the rotary selector, set the preferred end of cooking time.
4. Start with ▶.

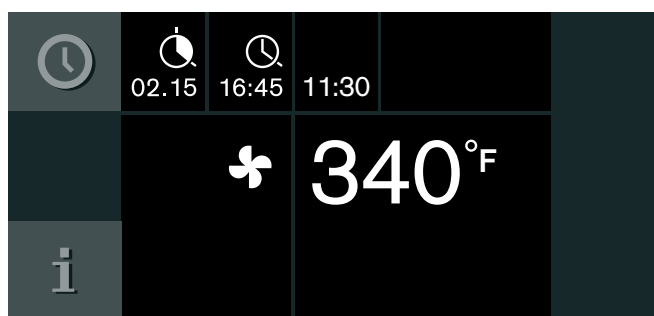

The appliance will go on standby. The screen will display the mode, temperature, cooking time, and end of cooking time. The appliance will start at the calculated time and will turn off automatically once the cooking time has run out.

Note: If the 🕒 symbol is blinking: a cooking time has not been set. Always set the cooking time first.

The appliance will turn off after the cooking time has ended. The 🕒 symbol will pulse and a signal will sound. It will stop when you touch the ✓ symbol, open the appliance door, or set the program selection to 0.

Change end of cooking time:

Call up timer menu. Using the ➤, select 🕒 "end of cooking time". Using the rotary selector, set the preferred end of cooking time. Start with ▶.

Cancel complete process:

Set program selection to 0.

Set time functions for both ovens simultaneously

Short-term timer and stopwatch are not available when both ovens are in use.

Cooking time and end of cooking time can be set simultaneously for both ovens.

Set a heat mode and temperature for both ovens. Select the preferred oven using 🗄 or 🗄 and set the cooking time.

If the cooking time was only set for one oven, the settings will be displayed on the left side of the screen. The 🗄 or 🗄 symbols display whether the settings are for the upper or lower oven.

Example: it is 12:00. A 45-minute cooking time is set for the lower oven. The cooking time will end at 12:45.

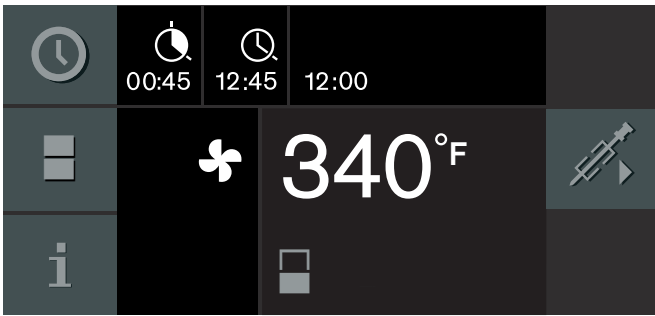

The  symbol will bring up an overview. This is where you can select the upper or lower oven.

If a cooking time was set for both ovens, the overview will display the lower oven settings on the left and the upper oven settings on the right side of the screen:

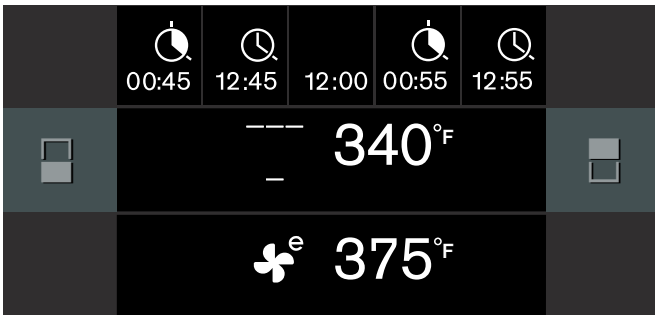

Sabbath mode and Yom Tov mode

Sabbath mode





With this function, the appliance maintains a temperature between 120 and 450°F (50 and 230°C) with the convection heating function.

You can keep dishes warm for up to 74 hours without having to switch on or off.



Note that easily perishable foodstuffs must not be left in the oven for too long.

Note: You must activate the Sabbath mode in the factory setting in order to operate the mode. → "Basic settings" on page 30

Follow these steps:

1. Set the program selector to **S**.
2. Select "Factory setting" with the rotary selector.
3. Confirm by touching the  symbol.
4. Rotate the selector to Sabbath mode .
5. Confirm by touching the  symbol.
6. Rotate the selector to "activate".
7. Confirm by touching the  symbol.
8. Turn the oven off.

Setting the Sabbath mode

1. Set the program selector to . To set the Sabbath mode for both ovens, set both program selectors to .
2. Touch the  symbol.



The suggested value of 24h at 185° F (85° C) appears in the display. Start with 

- or -

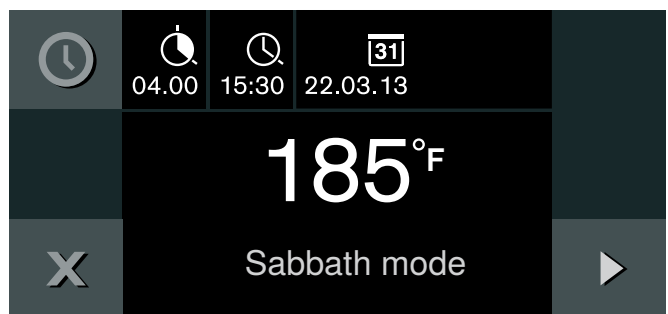
Change the cooking time and the temperature.



3. Changing the cooking time :

Touch the  symbol. Set the preferred cooking time with the rotary selector. You can set up to 74 hours. Confirm by touching the  symbol. Then changing the temperature becomes an option.

4. Changing the temperature:
Set the required temperature with the rotary selector.
5. Start with ►.

The appliance starts. ⌚ and the temperature appear in the display. The Sabbath screen will appear as shown.



The oven and display lighting is off. The control panel is blocked and no tone can be heard when you touch it.

The appliance no longer heats after expiry of the time. The display is blank. Set the program selector to 0.

Switching off:

To cancel the operation, set the program selector to 0.

Yom Tov mode

With this function, the appliance is programmed to perform in three stages.

Stage 1 and 2 can be programmed for a maximum total duration of 74 hours. The duration of Step 3 is 1 hour and cannot be modified.

Stage 1: maintains a warm temperature of 122° F (50° C) in the convection heating function. The interior oven lights remain off through this stage.

Stage 2: the appliance raises to a desired temperature setting and maintains a temperature between 120 and 450° F (50 -230° C). For warming and cooking foods in the convection heating function. The desired time can be adjusted for this stage. The interior oven lights will be on during this time.

Stage 3: maintains a warm temperature of 122° F (50° C) in the convection heating function for 1 hour after stage 2 has ended. The interior oven lights will be on during this time.

Note that easily perishable foodstuffs must not be left in the oven for too long.

Setting the Yom Tov mode

1. Set the program selector to ⌚. To set the Yom Tov mode for both ovens, set both program selectors to ⌚.

2. Touch the ⌚ symbol.

The suggested value of 24h at 185° F (85° C) appears in the display.

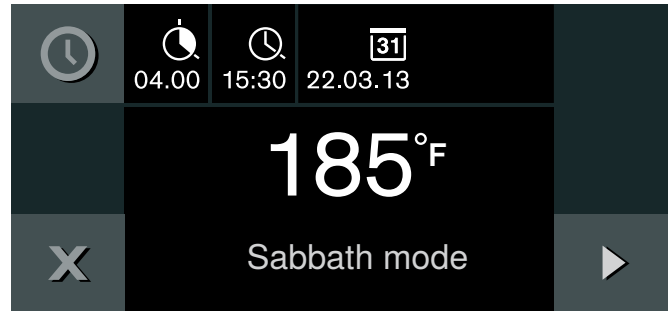

To set Stage 2 cooking time with rotary selector:

1. Touch the ⌚ symbol to adjust the duration of Stage 2 cooking time ⌚.
2. Set the desired Stage 2 cooking time with the rotary selector.
3. Touch the ► symbol to adjust the end of Stage 2 cooking time ⌚.
4. Select the end time with the rotary selector.
5. Change the date if needed by touching the ► symbol to 📅.
6. Rotate the selector to the desired date.
7. Confirm settings by touching the ✓ symbol.

To set Stage 2 temperature:

1. Rotate selector to desired Stage 2 temperature.
2. Start with ►.

The temperatures of Stage 1 and Stage 2 appear in the display. The remaining time to the beginning of Stage 2 is counted down in the display. The Yom Tov screen will appear as shown.

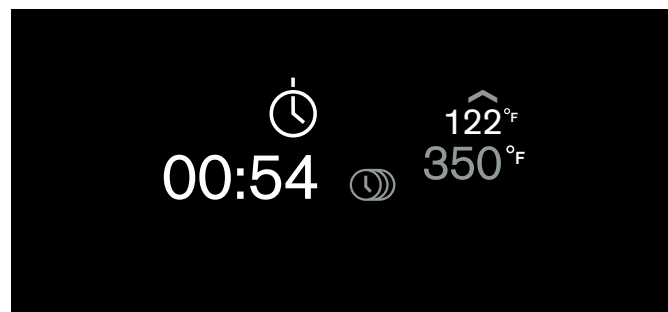

The program will begin with the pre-set warm temperature without light, then advance to the programmed temperature with light until the end of the set date and time, and then maintain the pre-set warm temperature for 60 minutes.

The appliance no longer heats after expiry of the time. The display is blank. Set the program selector to 0.

Switching off:

To cancel the operation, set the program selector to 0.

Core temperature probe

The core temperature probe makes it possible to cook with exact precision. It measures the temperature inside the food being cooked. When the required core temperature has been reached, the probe switches off automatically, ensuring that all food is cooked perfectly.

⚠ WARNING

Risk of electric shock!

Use of a wrong core temperature probe can damage the insulation. Use only the core temperature probe intended for this appliance.

⚠ WARNING

Risk of burns!

The oven interior and the core temperature probe become very hot. Use oven mitts to plug and unplug the core temperature probe.

⚠ CAUTION

Damage to the core temperature probe:

Do not use the core temperature probe with the heating modes "Broil" or "Economy Broil". Before using the heating modes "Broil" or "Economy Broil", remove the core temperature probe from the oven cavity. It is possible to use the heating mode "Broil + Circulated Air" at temperatures up to 480° F (250 °C).

⚠ CAUTION

Damage to the core temperature probe:

The core temperature probe may be damaged at temperatures above 480° F (250 °C). When using the core temperature probe, never set the temperature above 480° F (250 °C).

Only use the core temperature probe supplied. You can purchase it as a spare part from Customer Service or from the online shop.

When using the core temperature probe, never place the food on the top shelf position in the oven.

After use, always remove the core temperature probe from the oven cavity. Never store it inside the oven cavity.

After each use, clean the core temperature probe with a damp cloth. Do not clean in the dishwasher.

Inserting the core temperature probe into the food

Insert the core temperature probe into the food before you place the food in the oven cavity.

The core temperature probe has three measuring points. Insert the core temperature probe as far as possible. The core temperature probe must not be inserted in the fat or be touching the ovenware or bones.

Meat: Insert the core temperature probe at an angle from above as far as it will go into the meat.

For more than one piece of meat, insert the core temperature probe into the middle of the thickest piece.

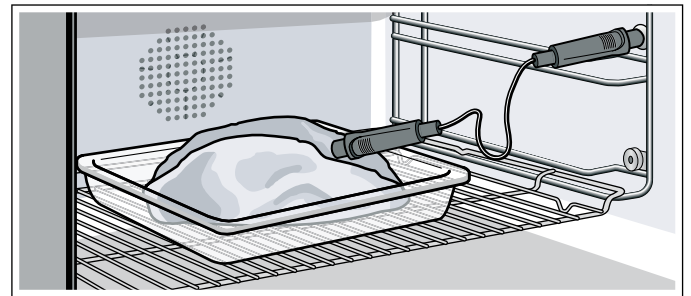

Poultry: Insert the core temperature probe as far as it will go into the thickest point in the breast. Depending on its structure, insert the core temperature probe into the poultry crossways or lengthways. With poultry, make sure that the tip of the core temperature probe does not protrude into the cavity in the middle of the bird.

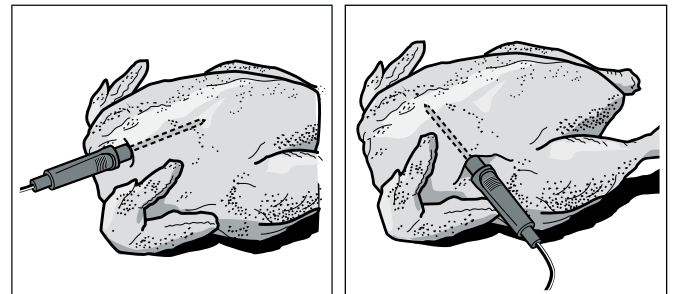

Fish: Insert the core temperature probe behind the head as far as it will go towards the spine. Place the whole fish onto the wire rack and prop it up in the swimming position using half a potato.

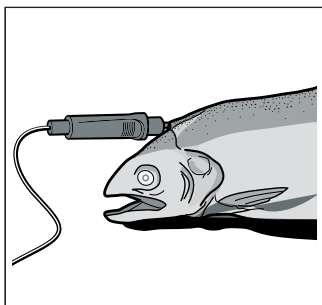

Turning the food: If you want to turn the food, do not remove the core temperature probe. Once you have turned the food, check that the core temperature probe is correctly positioned in the food.

If you remove the core temperature probe during operation of the appliance, all settings are reset and you have to apply them again.

Setting the core temperature

⚠ CAUTION

Damage to the core temperature probe:



The core temperature probe may be damaged if the distance between the grill heating element and the core temperature probe is too small. Make sure that the distance between the grill heating element and the core temperature probe or the cable of the core temperature probe is a few centimeters. The meat may expand during the cooking process.

⚠ CAUTION

Damage to the core temperature probe:

Do not trap the cable of the core temperature probe in the appliance door.

1. Insert the food to cook in the oven cavity with a core temperature probe inserted. Insert the core temperature probe into the socket in the oven cavity and close the appliance door.
2. Turn the function selector to the desired heating type.
3. Use the rotary selector to set the oven cavity temperature.

4. Touch the  symbol. Use the rotary selector to change the set core temperature for the food and confirm with .

The core temperature set must be higher than the current core temperature.

5. The appliance heats with the set heating type.

The display indicates the current temperature, and below that the set core temperature.

You can change the set core temperature at any time.

Once the set core temperature is reached, a signal sounds. Cooking is automatically ended. Confirm with  and turn the function selector to 0.

Estimated cooking time

After preheating, if the appliance has a temperature setting above 212° F (100 °C), when the core temperature probe is inserted, the display shows an estimated cooking time approx. 5–20 minutes into the cooking time.

The estimated cooking time is continually updated. The longer the cooking process lasts, the more precise the estimated cooking time becomes. Do not open the appliance door; this distorts the estimated cooking time.

The estimated cooking time is displayed in normal operation and in the automatic program.



The current core temperature is shown in the display when you touch the **i** symbol.

The estimated cooking time display can be deactivated in the basic settings so that the current core temperature is shown instead. → "Basic settings" on page 30

Notes

- At the beginning of the cooking time, "<59° F" ("<15° C") is displayed for 3-4 minutes for the current core temperature.
- The measurable range is 59 to 210° F (15°C to 99°C). Outside the measurable range, <59°F or --°F ("<15° C" or "--° C") is displayed as the current core temperature.
- If you leave the food in the cooking compartment for some time after cooking, the core temperature will continue to rise somewhat due to the residual heat in the cooking compartment.
- If you set programs with the core temperature probe and the cooking timer at the same time, the appliance switches off whichever program reaches the entered value first.

Changing the set core temperature

Touch the  symbol. Use the rotary selector to change the set core temperature for the food and confirm with .

Deleting the set core temperature

Touch the  symbol. Delete the set core temperature with **C**. The appliance continues heating in normal cooking mode.

Core temperature guidelines

Use chilled food only, not frozen food. The details given in the table are guidelines. Results depend on the quality and composition of the food.

For hygiene reasons, critical foodstuffs such as fish and game should reach a core temperature of 143 - 158° F (62 - 70 °C); for poultry and minced meat this should be as high as 176 - 185° F (80 - 85 °C).

Food	Core temperature guideline
Beef	
Sirloin, tenderloin, entrecôte	
very rare	113 - 117°F (45 - 47 °C)
rare	122 - 126°F (50 - 52 °C)
medium	137 - 140°F (58 - 60 °C)
well-done	158 - 167°F (70 - 75 °C)
Roast beef	176 - 185°F (80 - 85 °C)
Pork	
Pork roast	162 - 176°F (72 - 80 °C)
Pork loin	
medium	149 - 158°F (65 - 70 °C)
well-done	167°F (75 °C)
Meat loaf	185°F (85 °C)
Fillet of pork	149 - 158°F (65 - 70 °C)
Veal	
Veal roast, well-done	167 - 176°F (75 - 80 °C)
Breast of veal, stuffed	167 - 176°F (75 - 80 °C)
Saddle of veal	
medium	137 - 140°F (58 - 60 °C)
well-done	149 - 158°F (65 - 70 °C)

Food	Core temperature guideline
Fillet of veal	
rare	122 - 126°F (50 - 52 °C)
medium	137 - 140°F (58 - 60 °C)
well-done	158 - 167°F (70 - 75 °C)
Game	
Saddle of venison	140 - 157°F (60 - 70 °C)
Leg of venison	158 - 167°F (70 - 75 °C)
Venison loin steaks	149 - 158°F (65 - 70 °C)
Saddle of hare or rabbit	149 - 158°F (65 - 70 °C)
Poultry	
Chicken	195°F (90 °C)
Guinea fowl	175 - 185°F (80 - 85 °C)
Goose, turkey, duck	185 - 195°F (85 - 90 °C)
Duck breast	
medium	131 - 140°F (55 - 60 °C)
well-done	158 - 176°F (70 - 80 °C)
Ostrich steak	140 - 149°F (60 - 65 °C)
Lamb	
Leg of lamb	
medium	140 - 149°F (60 - 65 °C)
well-done	158 - 176°F (70 - 80 °C)
Saddle of lamb	
medium	131 - 140°F (55 - 60 °C)
well-done	149 - 167°F (65 - 75 °C)
Mutton	
Leg of mutton	
medium	158 - 167°F (70 - 75 °C)
well-done	176 - 185°F (80 - 85 °C)

Food	Core temperature guideline
Saddle of mutton	
medium	158 - 167°F (70 - 75 °C)
well-done	176 °F (80 °C)
Fish	
Fillet	144 - 149°F (62 - 65 °C)
Whole	149°F (65 °C)
Terrine	144 - 149°F (62 - 65 °C)
Other provisions	
Bread	205°F (96 °C)
Paté	162 - 167°F (72 - 75 °C)
Terrine	140 - 158°F (60 - 70 °C)
Foie gras	113°F (45 °C)
Reheating food	167°F (75°C)

Rotisserie spit

The rotisserie spit is particularly good for cooking large roasts, such as rolled roasts or poultry. The meat becomes crispy and brown.

You can use the rotisserie spit with all operating modes. You will get the best results with "Full surface grill" and "Top heat".

Note: The rotisserie spit operation is only available in the lower oven.

! CAUTION

Do not use the temperature probe in combination with the rotisserie spit.

Preparation

1. Insert both supports in the sockets on the grill tray. The drive is on the left.
2. Plug the right retaining clip onto the rotisserie spit and screw it in firmly.
3. Place the food you want to cook on the rotisserie spit's center. Secure protruding parts (e.g. wings) to make sure they do not touch the grill heating element.

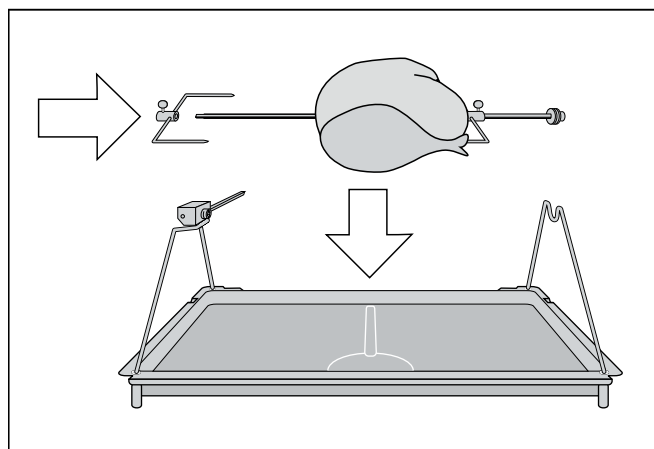

4. Plug the left retaining clip onto the rotisserie spit and screw it in firmly.

5. Place the rotisserie spit on the supports. Latch the square shaft into the drive section.

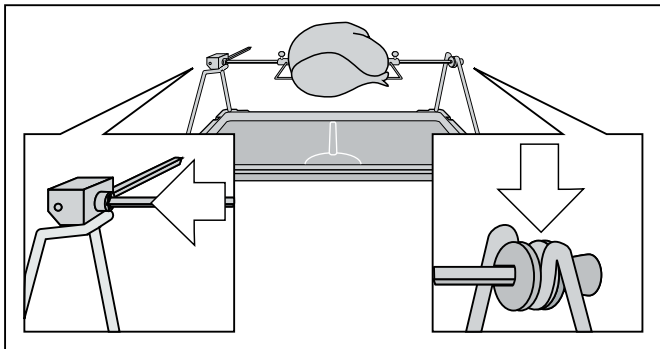

6. Insert the rotisserie spit in the lowest insertion level in the oven. The drive spindle must engage in the opening on the oven's rear wall.

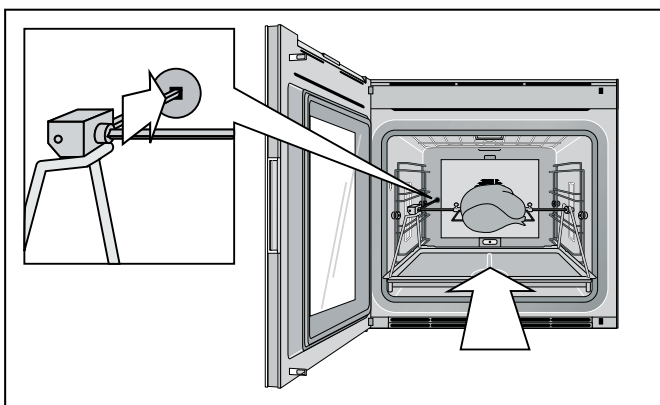

Turn on rotisserie spit

1. Set the desired temperature and heat mode.
2. Touch the  symbol. Rotisserie use is engaged.

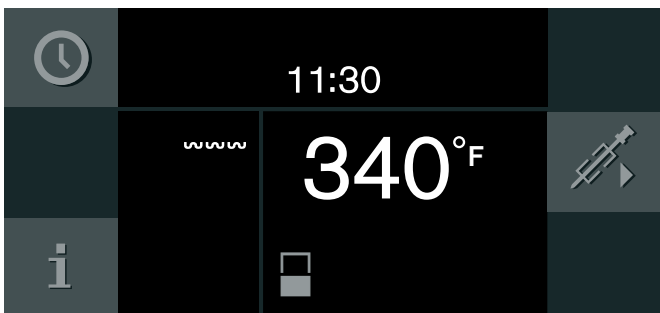

Switching off the rotisserie spit

1. Touch the  symbol. The rotisserie spit's drive stops.
2. Switch off the oven with the program selection.
3. Take out the grill tray with the rotisserie spit and place them on a stable, heat-resistant surface.

WARNING

Risk of burns!

Use a glove to remove them.

4. Screw on the handle at the side to remove the rotisserie spit.

Notes

- Use the rotisserie spit at oven temperatures up to 480° F (250° C) only.
- Do not clean the drive part of the rotisserie spit in a dishwasher.

Roasting function

Only with heating type "Roast":
In the pre-roast stage, the oven heats at full power for approx. 3 minutes. This way, you can cook steaks quickly.

Note: The pre-roast stage is only available in the lower oven.

Touch the **»»** symbol. The pre-roast stage starts up. You can also set the pre-roast feature several times one after another.

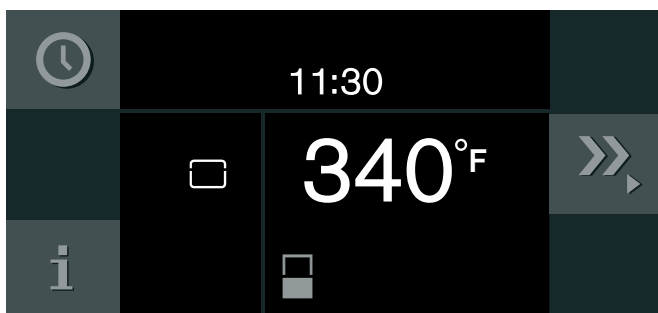

To end the pre-roast stage early, touch **»»**.

Childproof lock

The appliance has a panel lock to make sure children cannot operate it inadvertently.

Notes

- You must set the child lock in the factory setting to "Available" → "Basic settings" on page 30
- If there is a power cut while the child lock is activated, it may be deactivated when the power returns.

Activating the child lock

Requirement:

Program selector is set to **0**.

Touch the **🔒** symbol for at least 6 seconds.

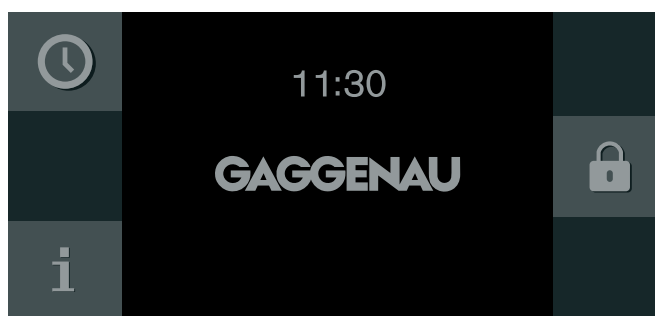

The child lock is activated. The standby screen appears. The **🔒** appears at the top of the display.

Deactivating the child lock

Requirement:

Program selector is set to **0**.

Touch the **🔓** symbol for at least 6 seconds.

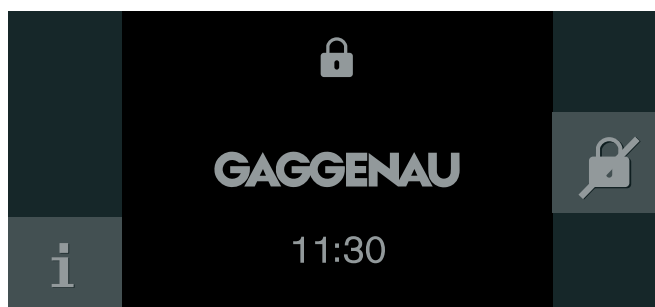





















The child lock is deactivated. You can switch on the appliance in the usual manner.

Basic settings

In the general settings, you can adapt your appliance individually.

1. Set the program selector to **S**.
 2. Select "General setting" with the rotary selector.
 3. Touch the ✓ symbol.
 4. Set the required general setting with the rotary selector.
 5. Touch the ↵ symbol.
 6. Set the general setting with the rotary selector.
 7. Save with ✓ or cancel with ✕ and quit the current general setting.
 8. Turn the program selector to **0** to quit the general setting menu.
- Changes are saved.

	Basic setting	Possible settings	Explanation
	Brightness	Stages 1, 2, 3, 4, 5*, 6, 7, 8	Setting display brightness
	Standby screen	On*/Off - Clock - Clock + GAGGENAU logo* - Date - Date + GAGGENAU logo - Clock + date - Clock + date + GAGGENAU logo	Appearance of the standby screen. Off: no display. Use this setting to reduce the standby consumption of your appliance. On: several displays can be set, confirm "On" with ✓ and choose the desired display with the rotary selector. The selection is displayed.
	Display screen	Minimized*/Standard	When 'Minimized' is set, only the most important details are displayed after a short time.
	Touchpad color	Gray*/White	Select the color of symbols on the touchpads
	Touchpad tone	Tone 1*/Tone 2/Off	Select the signal tone when touching a touchpad
	Touchpad volume	Levels 1, 2, 3, 4, 5*, 6, 7, 8	Sets the volume of the touchpad tone
	Quick heat	On*/off	With quick heat, the required temperature is reached particularly quickly.
	Preheating signal	On*/Off	The signal tone sounds when the required temperature is reached during preheating.
	Signal volume	Levels 1, 2, 3, 4, 5*, 6, 7, 8	Sets the volume of the signal tone
	Time format	AM/PM / 24 h*	Time display in 24 or 12-hour format
	Time	Current time	Setting the time

	Daylight savings	Manual*/Automatic	Automatic time changeover when changing daylight savings time. If automatic: setting of the month, day and week when the time is to be changed. To be set separately for summer and winter time.
	Date format	D.M.Y* D/M/Y M/D/Y	Setting the date format
	Date	Current date	Setting the date. Switch between the year/month/day with the > symbol.
	Temperature unit	°C* / °F	Setting the temperature unit
	Language	German* / French [...] / English US / English	Selecting the language for the text display Note: The system will restart if the language is changed. This process takes a few seconds. The basic settings menu is then closed.
	Factory settings	Restore appliance to factory settings	Confirm the question "Delete all individual settings and restore appliance to factory settings?" with ✓ or cancel with ✕. Note: When restoring factory settings, the personal recipes are also deleted. After restoring the factory settings, you will see the "Initial settings" menu.
	Demo mode	On/Off*	For presentation purposes only. The appliance does not heat in the demo mode, but all other functions are available. The "Off" setting must be activated for normal operation. The setting is only possible in the first three minutes after connecting the appliance.
	Sabbath mode	Not available*/Available	Available: Sabbath mode can be set.
	Display estimated cooking time with core temperature probe	On*/off	On: Estimated cooking time is shown in the display when the core temperature probe is used.
	Childproof lock	Not available*/Available	Available: The childproof lock can be activated. → "Childproof lock" on page 29

* Factory settings

Cleaning and maintenance

If taken care of and cleaned conscientiously, your appliance will stay beautiful and intact for a long time. Here we explain how to take care of and clean your appliance correctly.

WARNING

Risk of electrical shock!

Moisture entering the appliance can cause an electrical shock. Don't use a high-pressure cleaner or steam cleaner.

WARNING

Risk of burns!

- To avoid risk of injury, never touch the inside surfaces of the oven interior or heating elements. These surfaces are extremely hot after use. Always allow the appliance to cool down before touching or cleaning the interior.
 - Always turn off the interior light before cleaning the oven to allow the bulbs to cool down. The bulbs can become very hot when switched on. Keep the light off while cleaning the oven.
 - Keep children away.
-

WARNING

Risk of injury!

Scratched glass in the appliance door can burst. Do not use any glass scrapers or strong or abrasive cleaning agents.

WARNING

Do not clean the appliance while it is still hot. Some cleaners produce noxious fumes when applied to a hot surface. Wet clothes and sponges can cause burns from steam.

Cleaning agents

Pay attention to the information in the table to ensure that the various surfaces are not damaged by incorrect cleaning agents.

Do not use any

- sharp or abrasive cleaning agents
- metal or glass scrapers to clean the glass on the appliance door.
- metal or glass scrapers to clean the door seal.
- hard abrasive pads or cleaning sponges.

Thoroughly rinse out new sponge cloths before use.

Area	Cleaning agent
Door panels	Glass cleaner: Clean with a soft cloth or a microfiber cloth. Do not use a glass scraper.
Display	Wipe down using a microfiber cloth or a slightly damp cloth. Do not wipe with a wet cloth.
Stainless steel	Hot soapy water: Clean with a dish cloth and dry with a soft cloth. Remove flecks of lime scale, grease, starch, and albumin (e.g., egg white) immediately. Corrosion can form under such flecks. Special stainless steel cleaning agents are available from customer service or from specialist retailers.
Aluminum	Clean with a mild window cleaning agent. Using a window cloth or a lint-free microfiber cloth, wipe over the surfaces lightly in a horizontal direction.
Cooking compartment	Hot soapy water: Clean with a dish cloth and dry with a soft cloth.
Very dirty cooking compartment	Cleaning gel spray for ovens (order number 00311860 from customer service or in the online shop).
	Please note:
	<ul style="list-style-type: none"> • Must not come into contact with the door seal. • Leave for no more than 12 hours. • Do not use on hot surfaces. • Rinse thoroughly with water. • Observe the manufacturer's instructions.
Glass cover for the cooking compartment light	Hot soapy water: Clean with a dish cloth.

Area	Cleaning agent
Door seal Do not remove.	Hot soapy water: Clean with a dish cloth, do not scour. Do not use a metal or glass scraper for cleaning.
Core temperature sensor	Wipe with a damp cloth. Do not place in the dishwasher.
Accessories	Hot soapy water: Soak and clean with a dish cloth or brush.
Plug-in grids	Dishwasher, see section → <i>"Removing the plug-in grid" on page 33</i>
Rotary spit (not available with all oven models)	Hot soapy water: Clean with a dish cloth or brush. Do not soak or clean the rotary spit drive in the dishwasher.
Telescopic shelf (Optional accessory)	Hot soapy water: Clean with a dish cloth or brush. Do not soak or clean in the dishwasher.
Baking stone (Optional accessory)	Clean burnt-on residues with a brush. Never clean the baking stone when it is wet.
Roasting dish (Optional accessory)	Hot soapy water: Soak and clean with a dish cloth or brush. Do not clean the roasting dish in the dishwasher.

Microfiber cloth

The honeycomb microfiber cloth is particularly suitable for cleaning sensitive surfaces such as glass, glass ceramic, stainless steel or aluminum (product no. 00460770, also available from our online online shop). It removes liquid and greasy deposits in one go.

Removing the plug-in grid

The plug-in grids can be removed for cleaning.

Removing the plug-in grids

1. Put a dish towel in the cooking compartment to protect the enamel from scratches.
2. Loosen the knurled screws (Figure A).
3. Remove the plug-in grids (Figure B).

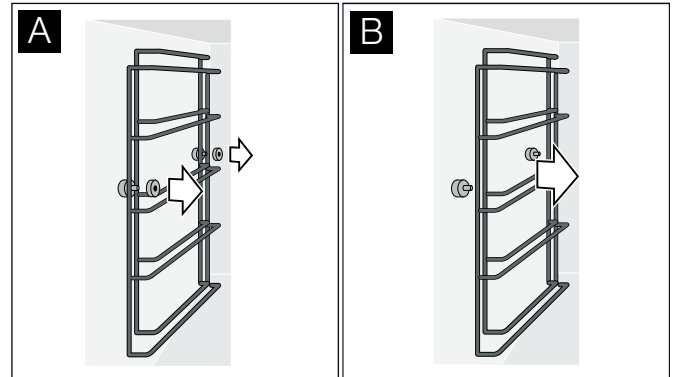

You can clean the plug-in grids in the dishwasher.

Hooking in the plug-in grids

1. Attach the plug-in grids all around: longer side toward the top. The right and left grids are identical.
2. Tighten the knurled screws.

Pyrolysis (self-cleaning)

During self-clean (pyrolysis), the oven heats up to 905°F (485°C). Thus, remainders from roasting, grilling or baking are burnt up and all you have to do is wipe the ash out of the interior.

Self-clean (pyrolysis) takes three hours. You can move the self-clean switch-off time (for example, if you would like it to run at night).

WARNING

During the elimination of soil during self-cleaning, small amounts of Carbon Monoxide can be created and the fiberglass insulation could give off very small amounts of formaldehyde during the first several cleaning cycles. To minimize exposure to these substances, provide good ventilation with an open window, or use a ventilation fan or hood.

Wipe out excessive spillage before self-cleaning the oven.

WARNING

Risk of fire!

Food remainders, grease or roast juice can catch fire during pyrolytic self-cleaning. Before every pyrolytic self-cleaning, remove coarse soiling from the oven interior and from accessories.

WARNING

Risk of fire!

The appliance becomes very hot during pyrolytic self-cleaning. Never hang flammable items such as dishcloths on the door handle. Keep the front of the appliance clear. Keep children away.

WARNING

Severe health risk!

The appliance becomes very hot during pyrolytic self-cleaning. The non-stick coatings on trays and forms are destroyed and toxic gases are produced. Never leave trays and forms with non-stick coatings in the oven during pyrolytic self-cleaning. Only leave enameled accessories in oven during self-clean cycle.

WARNING

Risk of burns!

The oven interior becomes very hot during pyrolytic cleaning. Never open the appliance door or the latching hook by hand. Allow the appliance to cool down. Keep children away.

WARNING

Risk of burns!

 The appliance will become very hot on the outside during the cleaning function. Never touch the appliance door. Allow the appliance to cool down. Keep children away from the appliance.

Do not clean parts or accessories in the self-clean oven.





Preparing the pyrolytic self-cleaning feature

CAUTION

Risk of fire! Loose food remnants, fat and meat juices may catch fire. Wipe the cooking compartment with a damp cloth.

- Remove the worst soiling and food residues from the oven.
- Clean the door seals, the inside of the door and the glass pane by hand as these parts are not cleaned during the pyrolytic self-cleaning cycle.
- Remove any loose parts from inside the cooking compartment. The plug-in grids are pyrolysis-proof. Make sure that nothing is left inside the cooking compartment.
- Bush for the additional heating element at the back of the cooking compartment: Make sure that the cover is in the bush.
- Close the oven door.

Starting the pyrolytic self-cleaning function

1. Set function selector to **S**.
2. The + symbol is displayed. Press  to confirm.
3. The switch-off time at which the pyrolytic self-cleaning function will be finished is displayed. If desired, change the switch-off time with the rotary selector. Press  to confirm.
4. Remove all accessories from the oven cavity and remove any coarse dirt. Press  to confirm.
5. Press  to start. The cleaning time counts down on the display. If the switch-off time has been delayed, the time until the pyrolytic self-cleaning function starts counts down in the display. The light in the oven cavity remains switched off.

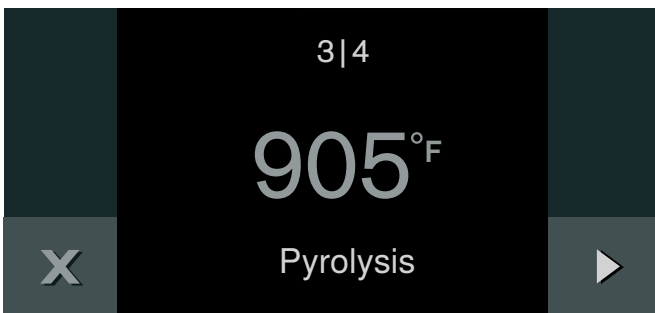

A signal sounds once the pyrolytic self-cleaning function has ended. A message appears in the display. Once the appliance has cooled down, wipe out the ash that has been left behind in the oven cavity with a damp cloth.

Notes

- The total duration of the pyrolytic self-cleaning function comprises the cleaning time and cooling period. The time for the relevant section of the pyrolytic self-cleaning function counts down on the display.
- For safety reasons, the oven door locks automatically. During cooling, the door mechanism is opened as soon as the temperature falls below 390°F (200 °C).

Depending on the type of soiling, white deposits may remain on the enamel surfaces. These deposits are residue from the food and are harmless. They do not affect how the appliance works. If required, you can remove these residues using lemon juice and a soft cloth.

Set self-clean (pyrolysis) for both ovens

You can set the self-clean (pyrolysis) so that both ovens are cleaned successively.

Between cleaning the first and second oven, the appliance will cool down for approx. 1 hour. Self-clean (pyrolysis) for both ovens takes approx. 8 hours.

To set self-clean (pyrolysis) for both ovens, turn both rotary selectors to **S**. Then set following the instructions in

Cleaning the Accessories with the Pyrolytic Self-cleaning Feature

Gaggenau baking trays and broiler pans are coated with pyrolysis-resistant enamel. For optimal results when cleaning the oven, we recommend removing all accessories from the oven before initiating the pyrolytic self-cleaning feature. This is the only way to achieve even heat distribution.

If you wish to remove burnt-on residue from your baking tray or broiler pan with the pyrolytic self-cleaning cycle, please observe the following instructions:

Notes

- Remove the worst soiling, meat juices, and food residues before initiating the pyrolytic self-cleaning cycle. Food residues, grease, and meat juices may catch fire during the pyrolytic self-cleaning cycle.
- Slide only one baking tray or broiler pan onto the lowest rack in the oven.
- Push the baking tray or broiler pan in as far as it will go.
- Wire rack, rotisserie spit, cast iron roaster, baking stone, core temperature sensor, or other accessories must not be cleaned in the pyrolytic self-cleaning cycle.
- Broiler pans with stainless steel bushings can discolor during the pyrolytic self-cleaning cycle. This does not affect its usability.



Troubleshooting

You can often easily eliminate problems that may occur on your own. Before calling Customer Service, take into account the following information.

WARNING

Risk of electric shock!

Improper repairs are dangerous. Only an authorized service provider may perform repairs and may replace damaged plug and connections. Remove the power plug or turn off the circuit breaker or fuse in the fuse box if the appliance is damaged or not working. Call Customer Service.

Disruption	Possible cause	Solution
Appliance not working, no display	Plug not inserted	Connect the appliance to the electricity mains
	Power failure	Check whether other kitchen appliances are working
	Fuse defective	Check in the fuse box whether the fuse for the appliance is in working order
	Operating error	Switch off the fuse for the appliance in the fuse box and switch it on again after about 10 seconds
Appliance cannot be started	Appliance door is not quite closed	Close appliance door
Appliance is not working, display is not responding.  appears in the display.	Child lock activated	Deactivate child lock (see section entitled 'Child lock')
Appliance switches off automatically	Safety deactivation: the appliance has not been operated for longer than 12 hours	Confirm the message with  , switch off the appliance and set it again.
Appliance does not heat up,  appears in the display	Appliance is in the demo mode	Deactivate demo mode in the basic settings
Error message "Exxx"		If an error message appears, turn the program selection to 0 ; if the display goes off, it was a one-time problem. If the problem occurs repeatedly or if the display stops, please contact after-sales service and inform them of the error code.

Power cut

Your appliance can bridge a power cut of a few seconds. Operation continues.

If the power cut was for a longer period and the appliance was in operation, a message appears in the display. Operation is interrupted.

Set the function selector to **0**, then the appliance can be operated again as usual.

Demo mode

The demo mode is activated if the  symbol appears in the display. The appliance does not heat up.

Briefly disconnect the appliance from the mains (switch off the domestic fuse or the circuit-breaker in the fuse box). Then deactivate the demo mode within 3 minutes in the factory setting. → "Basic settings" on page 30

Replacing the oven lamp

You can replace the oven lamps. You can obtain replacement lamps after-sales service or from trade dealers. Use the same type of halogen bulbs only.

- Top lamp:
60 W/230 V/G9
- Side lamp: 10 W/12 V/G4

WARNING

Risk of electric shock!

When you replace the oven interior lamp, the contacts of the lamp holder are live. Before replacing the lamp, remove the power plug or deactivate the circuit breaker or fuse in the fuse box.

WARNING

Risk of burns!

Lamps become very hot when switched on. There is still a risk of burning your skin for some time after they have been switched off. Allow lamps to cool down before replacing them.

Note: Always use a dry cloth to remove the halogen lamp from its packaging. This lengthens the lamp's useful life.

Replacing the top oven lamp

1. Undo the screw on the lamp cover. The lamp cover folds down.
2. Take out the halogen lamp. Insert the new halogen lamp.
3. Fold up and screw down the lamp cover.
4. Switch on the fuse in the fuse box again.

Replacing the side oven lamp

1. Place a dishcloth in the oven to avoid damage.
2. Undo the knurled screws on the slide-in rack. Remove the slide-in rack.
3. Press the top retaining spring to the side. Remove the glass cover.
4. Take out the halogen lamp. Insert the new halogen lamp.
5. Insert the glass cover at the bottom into the retaining spring and latch it at the top. The beveled side of the glass cover must point toward the oven.
6. Remove the dishcloth from the oven.
7. Switch on the fuse in the fuse box again.

Replacing the glass cover

The glass cover in the oven must be replaced if it is damaged. You can obtain covers from after-sales service. Always specify the E number and the FD number of your appliance.

Customer service

If your appliance needs repairs, our customer service is there for you. We work hard to help solve problems quickly and without unnecessary service calls, getting your appliance back up and running correctly in the least amount of time possible.

When you call, please indicate the product number (E-Nr.) and serial number (FD-Nr.) so that we can support you in a qualified manner. You will find the type plate with these numbers on the bottom of the appliance. To avoid having to search for a long time when you need it, you can enter your appliance data and the customer support telephone number here.

E-Nr.	FD-Nr.
Customer Service ☎	

Please read the use and care instructions provided with your appliance. Failure to do so may result in an error in using the appliance. This could result in a service call that instead of fixing a mechanical issue is only needed for customer education. Such calls are not covered by the appliance warranty.

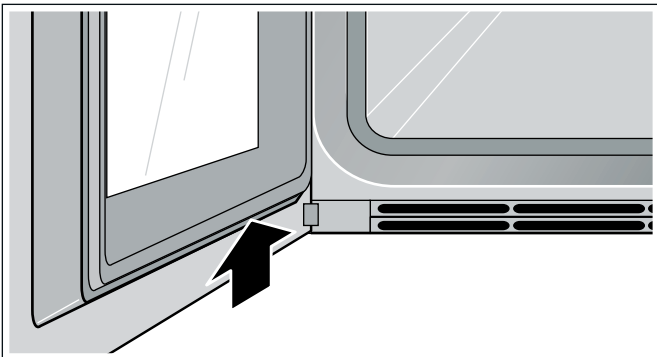

Please find the contact data of all countries in the enclosed customer service list.

To book a service visit and product advice

USA 877 442 4436
toll-free

CANADA 877 442 4436
toll-free

Tables and tips

Notes

- Always preheat the appliance.
This will produce the best cooking results. The cooking times specified refer to a preheated appliance.
- The values specified are intended as a guide. The actual cooking times depend on the quality and temperature of the food before cooking and the weight and thickness of the food to be cooked.
- The tables list temperature and/or time ranges. Try the lowest value to start. You can always choose a longer time next time if required.
A lower temperature results in more even browning. If necessary, set a higher temperature.
- The specifications refer to average quantities for four people. If you would like to prepare more, you should calculate a longer cooking time.
- Use the cookware specified. If you use other cookware, cooking times may be longer or shorter.
- You may use any heat-resistant cookware. Place the cookware in the center of the wire rack. For large roasts, you can also use the grill or glass tray.
- Do not place too many items close together on the wire racks or baking trays. This guarantees optimal heat circulation.
- To prepare bulky food items, you can remove the shelf supports at both sides. Place the wire rack directly onto the bottom of the oven cavity and place the food or roasting dish onto the wire rack. Do not place the food or roasting dish directly onto the enamel bottom of the oven cavity. Open the door of the preheated oven for a short time only when placing food inside the oven cavity.
- The details for the level refer to the slide-in level from below for appliances with 4 slide-in levels. The values in brackets refer to appliances with 5 slide-in levels.
- When removing glass cookware from the oven, set it down on a dry hot pad, never on a cold or wet surface. Otherwise, the glass may crack.
- Some operating modes are not available with all oven models or only with special accessories.
- **Eco hot air:**
Energy-saving hot air mode for cakes, meats, casseroles, and gratins. Residual heat is optimally used. Convenience functions remain switched off (e.g. the interior lighting). The interior temperature can only be displayed while the appliance is heating up. Do not preheat the oven.
Make sure that the oven cavity is cold and that there is nothing already in there when you place the food inside. Then start the specified cooking time. Always keep the appliance door closed when cooking. This prevents heat loss.

- **Full surface grill and full surface grill + circulated air:**
With these operating modes, there may be a temperature difference between the temperature you have set and the actual temperature inside the oven. This is because grilling and browning are fast cooking processes that require high temperatures. Consequently, for browning and roasting, a higher temperature than is actually needed on the surface of the food is selected.

Vegetables

- Vegetables from the oven are a good alternative to vegetables from the pan. The flavors are concentrated and the roasting aromas make them very aromatic. Furthermore, very little fat is required for preparation.
- Wash the vegetables and mix them in a bowl with a little oil. Place in a heat-resistant pan or distribute evenly in the glass/grill tray.
- During cooking, stir at least once. After cooking, adjust the spices and flavor to taste with fresh herbs.
- Vegetables are suitable as warm or cold appetizers or vegetarian main dishes, or also as side dishes to be served with fish and meat.
- For small portions (for 2-3 people), use an ovenproof dish and place it on the wire rack. Otherwise the food will burn or dry out in the glass/wire tray.
- Always follow the manufacturer's instructions for pre-cooked and frozen products.

Dish	Accessories	Level	Temperature in °F (°C)	Type of heating	Cooking time in min.	Comments
Vegetable skewers	Wire rack + Grill tray	3 (4)	430 (220)	~~~~~	24*	Cut wooden skewers short or soak in water overnight so they do not burn. Recipe tip: Peppers, onions, corn (pre-cooked), cherry tomatoes, zucchini
Green asparagus, grilled	Glass/grill tray	3 (4)	430 (220)	~~~~~	6-10*	Recipe tip: Season with onions, oil, vinegar, salt, and pepper.
Root vegetables	Glass/grill tray	3 (4)	390 (200)	✻	30*	Recipe tip: Season carrots, celery, rutabagas and red beets with oil, salt, and pepper.
		3 (4)	480 (250)	~~~~~	15-20*	
Pumpkin pieces	Glass/grill tray	3 (4)	390 (200)	✻	20 - 30*	Recipe tip: Season with oil, garlic, ginger, cumin, salt, and pepper.
Antipasti	Glass/grill tray	3 (4)	390 (200)	✻	30*	Recipe tip: Drizzle balsamic vinegar over the vegetables while they are still hot, and season them.
		3 (4)	480 (250)	~~~~~	15-20*	
Escalivada (Mediterranean oven-roasted vegetables)	Ovenproof dish	4 (5)	480 (250)	~~~~~	15*	Recipe tip: Aubergines, onions, tomatoes, peppers, oil. Delicious hot or cold.
Ratatouille	Glass/grill tray	3 (4)	390 (200)	--- ---	30-40*	Recipe tip: Sprinkle with parmesan just before serving.
Oven-roasted tomatoes	Ovenproof dish	2 (3)	250 (120)	✻	60	Recipe tip: Place cherry tomatoes or sliced tomatoes, rosemary, and garlic into the baking dish and drizzle with oil and a little honey. If you wish, you can blanch the tomatoes and peel them beforehand.

* Turn the food halfway through the cooking time.

Dish	Accessories	Level	Temperature in °F (°C)	Type of heating	Cooking time in min.	Comments
Chicory	Ovenproof dish	2 (3)	355 (180)	☛	25–30	Recipe tip: Halve, season, wrap in boiled ham, pour cream or béchamel sauce over the top and sprinkle with cheese.
		2 (3)	375 (190)	☛ ^e	45–50	No need to preheat; do not open appliance door.
Stuffed peppers, Stuffed peppers, vegetarian	Ovenproof dish/roasting dish	2 (3)	375 (190)	---	50	Recipe tip: Stuff with boiled rice, soft wheat or lentils and onions, cheese, herbs and seasoning/spices.
Stuffed courgettes, vegetarian	Glass/grill tray	2 (3)	355 (180)	---	40	Recipe tip: Stuff with grated carrot, spring onion, goats' cheese, garlic, thyme, salt and pepper and sprinkle with parmesan.
Vegetable bake	Ovenproof dish	2 (3)	355 (180)	☛	40–50	Pre-cook/blanch vegetables and other ingredients.
Veggie burgers, frozen	Baking tray + grease-proof paper	2 (3)	430 (220)	☛	12–15*	

* Turn the food halfway through the cooking time.

Side dishes and dishes

- The best side dishes from the oven are based on potatoes, for example potatoes au gratin. However, other outstanding side dishes can also be prepared in the oven, which normally are prepared in the pan (e.g. potato pancakes or fried potatoes). The advantages of this type of preparation: you can prepare larger quantities at once, the cooking smells are distributed less in the room, and you can prepare the dishes with less fat.
- Another versatile side dish from the oven is cheese. Cheese is an especially good addition to vegetarian dishes, or you can prepare the cheese as an appetizer or finger food.
- Dishes that are suited for preparation in the oven are especially dishes that are gratinated, such as casseroles and gratins. Suitable also are dishes with a dough base, e.g. pizza or tarte flambée, and egg dishes such as tortillas.
- For small portions (for 2-3 people), use an ovenproof dish and place it on the wire rack. Otherwise the food will burn or dry out in the glass/wire tray.
- Always follow the manufacturer's instructions for pre-cooked and frozen products.

Dish	Accessories	Level	Temperature in °F (°C)	Type of heating	Cooking time in min.	Comments
Side dishes						
Potatoes on a bed of coarse salt	Ovenproof dish	2 (3)	390 (200)	---	40–60*	Fill the ovenproof dish with 2 cm of sea salt. Place small potatoes in the dish with their skins on and brush them with olive oil.
Potato wedges	Baking tray + Grease-proof paper	2 (3)	390 (200)	☛	15*	Recipe tip: Cut the potatoes into wedges and season them with olive oil, paprika and salt.

* Turn the food halfway through the cooking time.

Dish	Accessories	Level	Temperature in °F (°C)	Type of heating	Cooking time in min.	Comments
Chips, fresh	Baking tray + Grease-proof paper	3 (4)	390 (200)	✿	15–20*	Recipe tip: Cover with a little oil; season with salt and paprika or curry powder after cooking.
Chips, frozen	Baking tray + Grease-proof paper	3 (4)	430 (220)	✿	14*	
Potato gratin	Ovenproof dish	2 (3)	355 (180)	✿	35	No need to preheat; do not open appliance door.
		2 (3)	375 (190)	✿ ^e	55–60	
Potato pancakes	Baking tray	2 (3)	345 (175)	✿	20–30*	Oil the baking tray liberally, squeeze out the excess liquid from the potato pancake mixture and brush with a little oil. Turn once.
		2 (3)	390 (200)	---	20–30*	
Roasted potatoes	Grill tray	2 (3)	355 (180)	✿	30–45*	Low-fat preparation. Distribute evenly on the grill tray, mix several times.
Goats' cheese in a bacon blanket	Glass tray/ baking tray	2 (3)	430 (220)	✿	8–10	Fresh goat's cheese or goat camembert works well.
		3 (4)	430 (220)	~~~~	8–10	
Goat's cheese with honey	Glass tray/ baking tray	2 (3)	390 (200)	✿	8	Recipe tip: Drizzle lavender honey over the goat's cheese or goat camembert and sprinkle with pine nuts.
		3 (4)	390 (200)	~~~~	8	
Baked camembert, breaded, fresh	Baking tray + grease-proof paper	2 (3)	355 (180)	✿	15–20	Bake until the breadcrumb coating rises in the centre.
Baked camembert, breaded, frozen	Baking tray + grease-proof paper	2 (3)	355 (180)	✿	15–20	Bake until the breadcrumb coating rises in the centre.
		2 (3)	390 (200)	---	15	
Mozzarella sticks, frozen	Baking tray + grease-proof paper	2 (3)	355 (180)	✿	10	
Feta	Baking tray	2 (3)	480 (250)	~~~~	12	Recipe tip: Place in a baking dish with oil, tomatoes, onions, garlic and rosemary and season with salt and pepper.
Oven-baked cheese, fresh	Baking tray	2 (3)	355 (180)	✿	20	After 10 minutes, cut a cross into the soft cheese and break open. If possible, the baking dish should be not much larger than the cheese so that the cheese does not run.
Dishes						
Tortilla	Ovenproof dish	2 (3)	320 (160)	---	25	Recipe tip: With paprika, olives, onion, Serrano ham and Manchego cheese.
Farmers' omelette	Ovenproof dish	2 (3)	320 (160)	✿	40	Recipe tip: With green and white asparagus; also add gravlax.
Frittata	Ovenproof dish	2 (3)	375 (190)	---	45–50	Recipe tip: with spinach, onions, and shrimp.
Enchiladas, grilled	Glass dish/ grill tray	2 (3)	390 (200)	---	15–20	

* Turn the food halfway through the cooking time.

Dish	Accessories	Level	Temperature in °F (°C)	Type of heating	Cooking time in min.	Comments
Lasagne	Ovenproof dish	2 (3)	345 (175)	✿	35	Recipe tip: classic or vegetarian with grilled vegetables and Buffalo mozzarella.
		2 (3)	355–375 (180–190)	✿ ^e	55–60	No need to preheat; do not open appliance door.
Macaroni cheese	Ovenproof dish	2 (3)	355/430 (180/220)	✿	10–20	For a cheesy crust, increase the temperature to 430°F (220 °C) after 10 min. and let brown for 10 min.
Cheese spätzle (Swabian noodle dish)	Ovenproof dish	2 (3)	355/430 (180/220)	✿	30	Gradually layer the freshly-cooked spätzle in the baking dish, sprinkling each layer with cheese. Finally, top with cheese and roasted onions and increase the temperature to 430°F (220 °C) for 5 min.
Spring rolls, frozen	Baking tray + Grease-proof paper	2 (3)	435 (225)	✿	18–20*	
Mini spring rolls, frozen	Baking tray + Grease-proof paper	2 (3)	435 (225)	✿	10*	
Pizza, fresh	Baking tray	2 (3)	445–480 (230–250)	---	10–15	Lightly oil the baking tray.
Pizza, pre-baked	Baking tray + Grease-proof paper	2 (3)	445 (230)	✿	6–8	
		2 (3)	445 (230)	---	6–8	
Pizza, frozen	Wire rack	2 (3)	390 (200)	✿	11–13	
		2 (3)	445 (230)	---	11–13	
American pizza (deep pan), frozen	Baking tray	2 (3)	390 (200)	---	20–24	Do not preheat.
Tarte flambée, fresh	Baking tray	2 (3)	480 (250)	---	8–10	Recipe tip: Traditional or with goat's cheese, Parma ham, figs and spring onions.
Tarte flambée, pre-baked	Baking tray + Grease-proof paper	2 (3)	250	✿	7	
Tarte flambée, frozen	Wire rack	2 (3)	390 (200)	✿	10–12	
		2 (3)	445 (230)	---	8–10	
Quiche	Tart tin or dish	2 (3)	390 (200)	---	20 + 20	Pre-bake crust for 20 min., pour mixture into the crust, and bake another 20 min.
Onion tart	Baking tray	2 (3)	390 (200)	---	30–40	

* Turn the food halfway through the cooking time.

Fish

- Fish should (for hygienic reasons) have a core temperature of at least 144 - 158°F (62 - 70 °C) after cooking. This is also the ideal cooking point.
- Only salt the fish after cooking. Thus the natural aroma is retained and less water is removed from the fish.
- Oil the wire rack and baking tray a little bit, then the fish will not stick.
- For fillets with skin: if you place the fish skin-side up, the structure and aroma will be retained better.
- Cut wooden skewers short or soak in water overnight before skewering the ingredients so they do not burn.
- Always follow the manufacturer's instructions for pre-cooked and frozen products.

Dish	Accessories	Level	Temperature in °F (°C)	Type of heating	Cooking time in min.	Comments
Shrimp skewers, fresh	Wire rack + Grill tray	3 (4)	355 (180)	⋯⋯⋯	10*	
Shrimp skewers, frozen	Wire rack + Grill tray	3 (4)	355 (180)	⋯⋯⋯	12*	
Fish kebabs	Wire rack + Grill tray	3 (4)	390 (200)	⋯⋯⋯	12*	Use firm types of fish, e.g. salmon, coley, ocean perch and cod.
Trout, whole	Baking tray	3 (4)	380–430 (200–220)	⋯⋯⋯	16*	Recipe tip: Stuff with lemon, garlic, and parsley.
Sea bream, whole	Wire rack + Grill tray	3 (4)	380–430 (200–220)	⋯⋯⋯	20–25*	Recipe tip: Stuff with lemon, garlic and thyme, or use mint for a summery touch.
	Baking tray	3 (4)	375 (190)	✿	20–25*	Make a diagonal incision into the skin of the sea bream.
Salmon steak	Wire rack + Grill tray	3 (4)	480 (250)	⋯⋯⋯	10–12	Recipe tip: Marinate in a mixture of lime, salt, pepper, and garlic.
	Baking tray	2 (3)	390 (200)	✿	10–12	
Tuna steak	Baking tray	2 (3)	390 (200)	✿	8–10	Recipe tip: Season Asian-style with soy sauce, sesame oil, ginger, honey, garlic, chili, and coriander seeds.
Fish fingers, frozen	Baking tray + grease-proof paper	2 (3)	430 (220)	✿	15–17*	
Squid rings, frozen	Baking tray + grease-proof paper	2 (3)	430 (220)	---	8–12	

* Turn the food halfway through the cooking time.

Meat

- Use the core temperature sensor so that you can monitor the core temperature more easily. Information and optimum target temperatures can be found in the section entitled → *"Core temperature probe" on page 24.*
- Leaving meat to rest: Let meat rest for a further 10 - 15 minutes after cooking. This gives the meat a chance to "relax". The circulation of the meat juice slows down and there is less loss of juice when cutting into the meat. Large pieces of meat, such as roasts, can rest in the oven. Smaller ones, e.g. steaks, should rest outside the oven wrapped in aluminum foil.
- For small portions (2 - 3 people), use a heat-resistant pan so that the food does not burn or dry out.
- Use the grill tray or the roasting dish for a large roast and for types of preparation that generate a lot of liquid for roasting.
- For best results, leave meat to marinate overnight and remove it before roasting or grilling, e.g. using the back of a knife or a spoon. Otherwise, the herbs and spices will burn.

- If the roast gets too dark and the crust is burned in places, reduce the temperature the next time and check the rack level.
- If the roast is cooked but the sauce is burned on, next time use a smaller roasting dish and add more liquid. If the sauce is too watery, next time use a larger roasting dish and add less liquid.

Dish	Accessories	Level	Temperature in °F (°C)	Type of heating	Cooking time in min.	Observations
Beef						
Roast beef (3.3 lb / 1.5 kg)	Glass/grill tray	2 (3)	355 (180)	✚	90 - 120*	
Rump steak, medium rare (1.1 lb / 500 g)	Glass/grill tray	2 (3)	390 (200)	✚	30	Core temperature 150° F (65 °C)
		2 (3)	390 (200)	✚ ^e	45 - 50	Core temperature 150° F (65 °C). No need to preheat; do not open appliance door.
Roast beef/sirloin (2.2 lb / 1 kg) - rare	Glass/grill tray	2 (3)	445 / 355 (230 / 180)	✚	25 - 35**	Recipe tip: tastes very good with Béarnaise sauce or sliced cold with remoulade and roasted potatoes.
- medium	Glass/grill tray	2 (3)	445 / 355 (230 / 180)	✚	35 - 45**	
- well-done	Glass/grill tray	2 (3)	445 / 355 (230 / 180)	✚	50 - 60**	
Pork						
Fillet of pork, whole (0.9 lb / 400 g)	Glass/grill tray	2 (3)	445 / 355 (230 / 180)	✚	20 - 25**	Recipe tip: marinate with oil, garlic, and parsley.
Fillet of pork (0.6 lb / 250 g)	Glass/grill tray	2 (3)	355 (180)	✚	30	Core temperature 160° F (70 °C).
		2 (3)	355 (180)	✚ ^e	40 - 45	Core temperature 160° F (70 °C). No need to preheat; do not open appliance door.
Pork medallions	Glass/grill tray	2 (3)	410 (210)	☼	12 - 15*	Recipe tip: shortly before removing, put a piece of butter and a rosemary sprig in the glass/grill tray and continue cooking in the oven.
Pork roast - joint (2.2 lb / 1 kg)	Glass/grill tray	2 (3)	445 / 355 (230 / 180)	✚	45 - 50**	
Pork roast - neck (3.3 lb / 1.5 kg)	Glass/grill tray	2 (3)	445 / 355 (230 / 180)	✚	85 - 95**	
		2 (3)	445 / 355 (230 / 180)	☼	70 - 80**	
Pork roast with crust (3.3 lb / 1.5 kg)	Wire rack + Grill tray	2 (3)	355 / 390 (180 / 200)	☼	60 - 70***	
Pork knuckles	Wire rack + Grill tray	2 (3)	300 / 390 (150 / 200)	☼	40 - 45***	Cut roughly into skin so that it gets crusty.
Smoke-cured pork (2.2 lb / 1 kg)	Glass/grill tray	2 (3)	355 / 320 (180 / 160)	✚	50 - 60**	
Rolled pork	Glass/grill tray	2 (3)	445 / 355 (230 / 180)	✚	65 - 70***	
	Wire rack + Grill tray	2 (3)	445 / 355 (230 / 180)	☼	75 - 80***	

* First cook thoroughly in a pan/roasting dish on the burner.

** Brown the meat at high temperature, after 15 - 20 min. switch back to a lower temperature.

*** Cook meat at a low temperature, set the temperature higher for the last 15 - 20 min.

Dish	Accessories	Level	Temperature in °F (°C)	Type of heating	Cooking time in min.	Observations
Veal						
Veal roast (3.3 lb / 1.5 kg)	Glass/grill tray, roasting dish	2 (3)	445 / 355 (230 / 180)	---	50 - 60***	
Veal knuckle	Glass/grill tray, roasting dish	2 (3)	300 / 355 (150 / 180)	☞	50 - 60***	
Veal loin	Glass/grill tray, roasting dish	2 (3)	320 - 340 (160 - 170)	☞	20	
Stuffed breast of veal	Glass/grill tray, roasting dish	2 (3)	250 - 265 (120 - 130)	☞	120	
Game						
Wild boar roast	Glass/grill tray, roasting dish	2 (3)	340 (170)	☞	60 - 90*	Recipe tip: marinate overnight in oil, garlic, mustard, and herbes de Provence.
Leg of venison	Glass/grill tray, roasting dish	2 (3)	340 - 355 (170 - 180)	☞	60 - 80	
Saddle of venison	Glass/grill tray, roasting dish	2 (3)	330 - 345 (165 - 175)	☞	20	
		2 (3)	330 - 345 (165 - 175)	---	20 - 25	
Saddle of hare or rabbit	Glass/grill tray, roasting dish	2 (3)	355 (180)	☞	15 - 25*	Recipe tip: marinate in garlic, rosemary, olive oil, and high-quality balsamic vinegar.
Leg of lamb - medium	Glass/grill tray, roasting dish	2 (3)	355 - 375 (180 - 190)	☞	100*	Recipe tip: marinate overnight in olive oil, garlic, rosemary, and lemon peel.
- well-done	Glass/grill tray, roasting dish	2 (3)	355 - 375 (180 - 190)	☞	120*	
Knuckle of lamb	Glass/grill tray, roasting dish	2 (3)	355 - 390 (180 - 200)	☞	35 - 45	
Miscellaneous						
Meatballs (2.8 oz / 80 g each)	Baking tray + greaseproof paper	2 (3)	390 (200)	☞	30 - 35	The flatter the meatballs are, the quicker they will cook. Well-suited for large quantities.
Meatballs, cooked (2.8 oz / 80 g each)	Baking tray + greaseproof paper	2 (3)	390 (200)	☞	20	Well-browned and yet juicy meatballs: first cook in the pan and then put in the oven.
Meatballs (0.8 oz / 25 g each)	Baking tray + Greaseproof paper	2 (3)	390 (200)	☞	25 - 30	Recipe tip: very good for further combinations, e.g. meatballs with tomato sauce, Swedish meatballs, Königsberger meatballs.

* First cook thoroughly in a pan/roasting dish on the burner.

** Brown the meat at high temperature, after 15 - 20 min. switch back to a lower temperature.

*** Cook meat at a low temperature, set the temperature higher for the last 15 - 20 min.

Dish	Accessories	Level	Temperature in °F (°C)	Type of heating	Cooking time in min.	Observations
Meatballs, cooked (0.8 oz /25 g each)	Baking tray + Greaseproof paper	2 (3)	390 (200)	✦	15	Recipe tip: put meatballs of lamb or rabbit on a skewer and serve with minted yogurt or fig mustard.
Head cheese, fresh (1.5 lb /700 g)	Wire rack + Grill tray	2 (3)	320 (160)	✦	60	Use core temperature sensor (core temperature 153°F (67 °C)).
Bacon strips, thin	Baking tray + Greaseproof paper	3 (4)	355 (180)	✦	8 - 10	After taking out, let drip on a paper towel.
Bacon strips, thick	Baking tray + Greaseproof paper	3 (4)	375 (190)	✦	8 - 12	
Stuffed peppers with ground meat	Ovenproof dish/roasting dish	2 (3)	375 (190)	---	55 - 60	Recipe tip: fill with ground meat and cook in tomato sauce.

* First cook thoroughly in a pan/roasting dish on the burner.

** Brown the meat at high temperature, after 15 - 20 min. switch back to a lower temperature.

*** Cook meat at a low temperature, set the temperature higher for the last 15 - 20 min.











Poultry

- For better results, use the core temperature sensor. Do not place it in the middle (hollow space), but rather between the belly and upper thigh. For notes and optimal target temperatures, see chapter → "Core temperature probe" on page 24
- Poultry will turn out particularly crispy and brown if you baste it towards the end of the roasting time with butter, salted water, drippings or orange juice.
- When cooking duck or goose, pierce the skin on the underside of the wings to allow the fat to run out.
- Use a roasting dish or another heat-resistant pan for dishes that generate a lot of liquid for roasting. The same applies if a lot of fat can run out of the food, e.g. with roast goose.

Dish	Accessories	Level	Temperature in °F (°C)	Type of heating	Cooking time in min.	Observations
Duck, whole (3.3 - 4.4 lb /1.5 - 2 kg)	Wire rack + Grill tray/ roasting dish	2 (3)	320 / 355 (160 / 180)	---	75*	Recipe tip: fill with oranges, apples or dried fruit.
Duck breast	Roasting dish/oven-proof dish	2 (3)	375 (190)	☼	25 - 35	Tear skin roughly.
Goose, whole (11 lb /5 kg)	Wire rack + Grill tray/ roasting dish	2 (3)	320 / 375 (160 / 190)	✦	110 - 130*	Recipe tip: fill with apples, onions, and marjoram and pierce.
		2 (3)	320 / 375 (160 / 190)	---	110 - 130*	
Turkey hen, whole	Wire rack + Grill tray/ roasting dish	2 (3)	390 / 320 (200 / 160)	✦	120 - 180*	
		2 (3)	390 / 320 (200 / 160)	---	120 - 180*	

* Cook meat at a low temperature, set the temperature higher for the last 15 - 20 min.

** Turn food halfway through the cooking time.



Dish	Accessories	Level	Temperature in °F (°C)	Type of heating	Cooking time in min.	Observations
Chicken, whole	Wire rack + Grill tray	2 (3)	375 (190)		70 - 80	Preheat
		2 (3)	375 (190)		70 - 80	
Chicken, legs and thighs	Wire rack + Grill tray	3 (4)	430 (220)		30**	Recipe tip: Asian marinade with soy sauce, honey, chili, garlic, ginger, cumin, lime rub, coriander.
		3 (4)	430 (220)		30**	
Chicken legs	Wire rack + Grill tray	3 (4)	430 (220)		30**	After turning, the side with more skin should be up; this way, it gets crispy. Marinate with oil, rosemary, lime wedges, and garlic.
		3 (4)	430 (220)		30**	
Chicken breast	Wire rack + Grill tray	2 (3)	390 (200)		20 - 25	Recipe tip: before cooking, rub with Tandoori paste.
		2 (3)	390 (200)		50	
Chicken nuggets, frozen	Baking tray + Greaseproof paper	2 (3)	390 (200)		15**	
Breast of quail	Baking sheet	3 (4)	430 (220)		10 - 12	Baste with oil and spices, e.g. paprika, thyme, juniper, and garlic.
Quail, whole (0.3 lb /150 g each)	Wire rack + Grill tray	3 (4)	390 (200)		20 - 25	Baste with oil and spices, e.g. paprika, thyme, juniper, garlic.

* Cook meat at a low temperature, set the temperature higher for the last 15 - 20 min.

** Turn food halfway through the cooking time.

Grilling and roasting

- Do not grill food with the oven door open.
- Use the grill tray with inlaid shelf for grilling (depending on the version, accessory or special accessory). Pour approximately 100 ml water into the grill tray; this will catch the meat juices so that the oven stays clean. If you pour in too much water, this may alter the cooking result because too much steam will be produced.
- The pieces of food to be grilled should be of roughly the same thickness (at least 2 to 3 cm). This will allow them to brown evenly and remain succulent and juicy. Never add salt to meat before grilling it. Place the pieces to be grilled directly on the wire rack.
- If you use wooden skewers, these can burn. In order to prevent this, cut the skewers as short as possible or soak them overnight in water before spearing the ingredients, or use metal skewers.
- For small quantities, use the energy-saving "Compact grill" heating function. With this heating function, only the center part of the grill is heated. Place the food to be grilled in the middle of the wire rack.

Dish	Accessories	Level	Recommended temperature in °F (°C)	Type of heating	Cooking time in min.	Comments
Pork belly, sliced	Wire rack + grill tray	2 (3)	445 (230)		18 - 20*	
		2 (3)	445 (230)		18 - 20*	
Shish kebab	Wire rack + grill tray	3 (4)	375 (190)		16*	

* Turn the food halfway through the cooking time.

** Brown to the level you require.

Dish	Accessories	Level	Recommended temperature in °F (°C)	Type of heating	Cooking time in min.	Comments
Bratwurst (German sausage)	Wire rack + grill tray	3 (4)	520 (270)	~~~~~	10*	
Merguez sausage	Wire rack + grill tray	3 (4)	480 (250)	☼	12*	
Spare ribs, pre-cooked	Wire rack + grill tray	3 (4)	390–430 (200–220)	~~~~~	24*	
		3 (4)	390–430 (200–220)	☼	24*	
Spare ribs, raw	Wire rack + grill tray	3 (4)	430 (220)	~~~~~	40*	Recipe tip: Place in a mixture of oil, mustard, balsamic vinegar, honey, garlic, Worcester sauce, tomato purée and Tabasco sauce.
		3 (4)	430 (220)	☼	30*	
Chicken satay	Wire rack + grill tray	3 (4)	480 (250)	☼	10 - 14*	Serve with satay sauce.
Halloumi cheese (Grill cheese)	Wire rack + grill tray	3 (4)	480 (250)	☼	5 - 8	Halloumi is a firm cheese that is used in Turkish and Greek cuisine. It is very well-suited for grilling.
Toasting bread (Appliance width: 24 in / 60 cm)	Wire rack	3	390 (200)	~~~~~	2:30 - 3	Preheat for up to 5 minutes. Stay by the appliance so that the toast does not brown too much. Do not grill food with the oven door open.
Toasting bread (Appliance width: 30 in / 76 cm)	Wire rack	4	390 (200)	~~~~~	2 - 2:30	Preheat for up to 5 minutes. Stay by the appliance so that the toast does not brown too much. Do not grill food with the oven door open.
Toast Hawaii	Baking tray + greaseproof paper	3 (4)	375 (190)	☼	8 - 10**	
Croque monsieur	Baking tray + greaseproof paper	3 (4)	375 (190)	☼	8 - 11**	
Croutons	Baking tray	2 (3)	355 (180)	✻	15*	Recipe tip: Mix fresh white bread with olive oil, garlic and rosemary leaves. Do not use too much oil, and do not pour it on until you are ready to serve so that the bread cubes do not get soggy. Turn several times.
Browning meringue	Springform cake tin	2 (3)	430–480 (220–250)	~~~~~	4 - 5**	Stay by the appliance so that the meringue does not brown too much.
Dried plums wrapped in bacon	Baking tray + greaseproof paper	3 (4)	390 (200)	~~~~~	8 - 10	Also tastes good with dates or apricots.

* Turn the food halfway through the cooking time.

** Brown to the level you require.

Baked goods

- We recommend dark pans of metal since these absorb the heat better. Place the pan in the middle of the wire rack.
- For sheet cakes without greaseproof paper, oil the pan slightly.
- Small baked items such as cream puffs, cookies or pastries can be baked on two levels, 1+3 or 2+4.
- If you bake on several levels it is normal that the trays are not done at the same time. Leave the lower trays bake a little longer or put them in the oven earlier the next time.
- Before cutting, let the baked goods cool on a rack.
- If the baked goods are too dark on the bottom: insert one level higher, select a lower temperature.

If the baked goods are too dark on the top: insert one level lower, select a lower temperature, and extend the baking time a bit.

- If the cake is too dry, set the temperature a little higher. If the cake is not cooked on the inside, set the temperature a little lower.
Baking times cannot be shortened by selecting a higher temperature; it is better to select a somewhat lower temperature.
- If the cake collapses: use less liquid or set the temperature 50°F (10 °C) lower. Do not open the oven door too soon.
- The cake rises only in the middle: grease the edges of the pan.
- If the cookies are hard to take off the sheet, insert the sheet in the hot oven again and remove the cookies while they are still warm.
- If the cake does not come out of the pan when you turn it over, use a knife to loosen the cake around the edges. Turn the cake pan upside down again and cover it several times with a cold, wet cloth. Next time, grease the pan well and sprinkle some bread crumbs into it.
- Always follow the manufacturer's instructions for pre-cooked and frozen products.

Dish	Accessories	Level	Temperature in °F (°C)	Type of heating	Cooking time in min.	Comments
Cake						
Cheesecake	Springform cake tin	1 (2)	320–330 (160–165)	☛	70 - 75	
		1 (2)	320–330 (160–165)	---	70 - 75	
		1 (2)	320–330 (160–165)	☛	85 - 90	
		1 (2)	320–330 (160–165)	---	80 - 90	
		1 (2)	320–330 (160–165)	☛	40 - 45	Cheesecake with half quark filling.
Sponge cake	Springform cake tin	2 (3)	320–340 (160–170)	☛	50 - 60	
		2 (3)	320–340 (160–170)	---	50 - 60	
Loaf cakes	Loaf tin	2 (3)	320–340 (160–170)	☛	60 - 65	To ensure even browning, place the tin lengthwise in the cooking compartment.
		2 (3)	320–340 (160–170)	---	55 - 60	

* Pre-heat the appliance to the specified temperature. When putting in the food to be cooked, switch back to the second specified temperature.

** Deactivate the "Rapid heating" function in the basic settings → "Basic settings" on page 30

Dish	Accessories	Level	Temperature in °F (°C)	Type of heating	Cooking time in min.	Comments
Bundt cake, Ring cake	Ring cake tin	1 (2)	330 (165)	☛	30	Recipe tip: Classic Bundt cake or with bacon and walnuts.
		1 (2)	340 (170)	☛ ^e	55	No need to preheat; do not open appliance door.
Tray bakes	Baking tray	2 (3)	330–340 (165–170)	☛	20 - 30	Oil the baking sheet slightly.
		2 (3)	330–340 (165–170)	---	40 - 50	
Swiss roll	Baking tray + greaseproof paper	2 (3)	375 (190)	☛	6	Place dough on greaseproof paper sprinkled with sugar, then roll up.
Sponge base	Springform cake tin	2 (3)	300 (150)	☛	40 - 45	Line a springform cake tin with greaseproof paper.
Yeast tray bake	Baking tray	2 (3)	330 (165)	☛	30 - 35	Recipe tip: Top with plums, figs or onions and bacon.
		2 (3)	330 (165)	---	30 - 35	
Fruit flan on a shortcake base	Tart tin or dish	2 (3)	330 (165)	☛	40 - 50	Recipe tip: Top with strawberries or with apricots and marzipan.
		2 (3)	340 (170)	---	40 - 50	
		2 (3)	330 (165)	☛	45 - 55	
Tart	Tart tin or dish	2 (3)	375 (190)	☛	30 - 40	French flan with a shortcake base, e.g. tarte aux pommes, tarte tatin, tarte au chocolat, tarte au citron.
		2 (3)	375 (190)	---	30 - 40	
		2 (3)	375 (190)	☛	40 - 45	
		2 (3)	375 (190)	---	45 - 50	For light-colored tart tins or dishes.
Puff pastry strudel	Baking tray + greaseproof paper	2 (3)	390 (200)	☛	20 - 25	Recipe tip: Fill with custard and cherries or apples.
Apple pie (Appliance width: 24 in / 60 cm)	8" (20 cm) springform cake tin	2	320** (160**)	☛	90 - 105	Preheat
	8" (20 cm) springform cake tin	1	320** (160**)	---	90 - 100	Preheat
Apple pie (Appliance width: 30 in / 76 cm)	8" (20 cm) springform cake tin	3	320** (160**)	☛	85 - 100	Preheat
	8" (20 cm) springform cake tin	2	320** (160**)	---	100 - 110	Preheat
Water sponge cake (Appliance width: 24 in / 60 cm)	10¼" (26 cm) springform cake tin	2	320** (160**)	☛	22 - 30	Preheat
	10¼" (26 cm) springform cake tin	2	320** (160**)	---	20 - 30	Preheat

* Pre-heat the appliance to the specified temperature. When putting in the food to be cooked, switch back to the second specified temperature.

** Deactivate the "Rapid heating" function in the basic settings → "Basic settings" on page 30

Dish	Accessories	Level	Temperature in °F (°C)	Type of heating	Cooking time in min.	Comments
Water sponge cake (Appliance width: 30 in / 76 cm)	10¼" (26 cm) springform cake tin	3	320** (160**)	☛	22 - 30	Preheat
	10¼" (26 cm) springform cake tin	3	320** (160**)	---	25 - 30	Preheat
Small baked items						
Cream puffs, eclairs	Baking tray + greaseproof paper	2 (3)	355 (180)	☛	35	Recipe tip: Fill with vanilla cream, chocolate mousse, fruit or mocha cream.
		2 (3)	355 (180)	---	40	
		2 (3)	355 (180)	☛	35	
Biscuits, Viennese whirls	Baking tray	2 (3)	160 - 170	☛	15	
		2 (3)	160 - 170	---	18	
Small baked puff-pastry items	Baking tray + greaseproof paper	2 (3)	390 (200)	☛	15 - 20	
Filled puff pastry parcels	Baking tray + greaseproof paper	3 (4)	390 (200)	☛	15	Recipe tip: Fill with ham and cheese or apples and raisins.
Puff pastry	Baking tray + greaseproof paper	3 (4)	390 (200)	☛	15	Recipe tip: With sesame seed, poppy, sugar topping.
Puff pastry twists	Baking tray + greaseproof paper	3 (4)	390 (200)	☛	15	Recipe tip: With ham, cheese, nuts.
Puff pastry slices	Baking tray + greaseproof paper	2 (3)	390 (200)	☛	15 - 20	Recipe tip: Serve with custard and/or fruit.
Waffle biscuits	Baking tray + greaseproof paper	2 (3)	285 (140)	☛	8 - 10	Shape the dough while it is still hot, e.g. into horns or rolls for dessert.
Breadsticks	Baking tray + greaseproof paper	2 (3)	320 (160)	☛	30	Sprinkle with sea salt, rosemary, curry powder, sesame seeds or caraway seeds.
Cookies (0.7 oz / 20 g each)	Baking tray + greaseproof paper	2 (3)	345 (175)	☛	12 - 14	With chocolate, raisins, nuts, or lemon.

* Pre-heat the appliance to the specified temperature. When putting in the food to be cooked, switch back to the second specified temperature.

** Deactivate the "Rapid heating" function in the basic settings → "Basic settings" on page 30

Dish	Accessories	Level	Temperature in °F (°C)	Type of heating	Cooking time in min.	Comments
Brownies	Baking tray + greaseproof paper	2 (3)	250 (120)	✿	60	After baking, cut into squares. The low temperature means that the brownies retain a slightly sticky consistency in the middle.
		2 (3)	355 (180)	✿ ^e	40 - 45	No need to preheat; do not open appliance door.
Muffins	Muffin tray/ paper cases	2 (3)	320 (160)	✿	25 - 30	With chocolate, nuts, or raisins.
		2 (3)	320 (160)	---	25 - 30	
		2 (3)	320-330 (160-165)	-	25 - 30	
Small cakes (Appliance width: 24 in / 60 cm)	Glass tray	2	300** (150**)	✿	25 - 30	Preheat
	Baking tray	3	300** (150**)	✿	28 - 32	Preheat
	Glass tray	1				Application on two levels
	Glass tray	3	320** (160**)	---	20 - 25	Preheat
Small cakes (Appliance width: 30 in / 76 cm)	Glass tray	3	300** (150**)	✿	26 - 32	Preheat
	Baking tray	4	300** (150**)	✿	30 - 32	Preheat
	Glass tray	2				Application on two levels
	Glass tray	4	320** (160**)	---	23 - 24	Preheat
Viennese whirls (Appliance width: 24 in / 60 cm)	Baking tray	2	285** (140**)	✿	35 - 40	Preheat
	Baking tray	3	285** (140**)	✿	35 - 40	Preheat
	Glass tray	1				Application on two levels
	Baking tray	2	285** (140**)	---	26 - 30	Preheat
Viennese whirls (Appliance width: 30 in / 76 cm)	Baking tray	3	285** (140**)	✿	30 - 35	Preheat
	Baking tray	4	285** (140**)	✿	30 - 40	Preheat
	Glass tray	2				Application on two levels
	Baking tray	3	285** (140**)	---	30 - 35	Preheat
Bread, rolls						
Multi-grain bread	Baking tray + greaseproof paper	2 (3)	390/340* (200/170*)	✿	40 - 50	
		2 (3)	390/340* (200/170*)	---	40 - 50	
		2 (3)	390/330* (200/165*)	-	45 - 50	
Sourdough bread	Baking tray	2 (3)	390/355* (200/180*)	---	50 - 60	
Olive-tomato bread	Baking tray	2 (3)	390/340* (200/170*)	---	40 - 50	

* Pre-heat the appliance to the specified temperature. When putting in the food to be cooked, switch back to the second specified temperature.

** Deactivate the "Rapid heating" function in the basic settings → "Basic settings" on page 30

Dish	Accessories	Level	Temperature in °F (°C)	Type of heating	Cooking time in min.	Comments
Bread, in loaf pan	Loaf tin	2 (3)	345 (175)	---	40 - 45	
Baguette, pre-baked	Baking tray + greaseproof paper	2 (3)	430 (220)	---	10 - 12	
Ciabatta, pre-baked	Baking tray + greaseproof paper	2 (3)	375 (190)	---	12 - 14	
		2 (3)	355 (180)	✿	12 - 14	
Flatbread	Baking tray + greaseproof paper	2 (3)	390 (200)	✿	15 - 20	The cooking time depends on the size and thickness of the flatbread.
		2 (3)	410 (210)	---	15 - 20	
Foccacia	Baking tray + greaseproof paper	2 (3)	410 (210)	---	15 - 20	Top with various ingredients, e.g. herbs, sea salt, olives, anchovies, onions, ham, tomatoes, or cheese.
Garlic/herb baguette	Baking tray + greaseproof paper	2 (3)	390 (200)	---	8 - 10	
Puff pastry strudel	Baking tray + greaseproof paper	2 (3)	390 (200)	✿	20 - 25	Recipe tip: Fill with sheep's milk cheese and feta.
Plaited loaf	Baking tray + greaseproof paper	2 (3)	330 (165)	✿	20	No need to preheat; do not open appliance door.
		2 (3)	340 (170)	✿ ^e	30 - 35	
Rolls, pre-baked	Baking tray + greaseproof paper	2 (3)	410 (210)	---	8 - 10	
		2 (3)	390 (200)	✿	8 - 10	
Rolls, frozen	Baking tray + greaseproof paper	2 (3)	355 (180)	✿	10 - 12	
		2 (3)	390 (200)	---	10 - 12	
Rolls, fresh (1.7 oz / 50 g each)	Baking tray + greaseproof paper	2 (3)	480/390* (250/200*)	---	15 - 20	
Pretzel products, frozen	Baking tray + greaseproof paper	2 (3)	390 (200)	✿	10 - 12	
Croissants, frozen	Baking tray + greaseproof paper	2 (3)	340 (170)	---	15 - 25	

* Pre-heat the appliance to the specified temperature. When putting in the food to be cooked, switch back to the second specified temperature.

** Deactivate the "Rapid heating" function in the basic settings → "Basic settings" on page 30







Dough proving (leaving to rise)

- Place the bowl with the dough on the wire rack. Select the "dough proofing" heating function.
- For large quantities, e.g. bread, set the temperature to 100 - 105°F (38 - 40°C). This way, the dough rises evenly from the middle to the edges.
- For small quantities of dough, for noodles or rolls, you can set the temperature to 105 - 115°F (40 - 45 °C).
- The suggested cooking time is only a guideline. Let the dough proof until its volume has doubled.
- If the dough does not rise, you have used too little yeast or not kneaded the dough enough.

Dish	Accessories	Level	Temperature in °F (°C)	Type of heating	Cooking time in min.	Observations
Dough	Bowl	2 (3)	100 - 115 (38 - 45)		25 - 45	e.g. yeast dough, natural fermentation starter, sourdough, dumplings

Desserts

- Oven-cooked desserts are very easy to prepare – you just have to put it in the oven. This preparation method is well-suited for larger quantities, for example if you have guests.
- Oven-cooked desserts are generally eaten warm, and are particularly enjoyable during the cooler months.

Dish	Accessories	Level	Temperature in °F (°C)	Type of heating	Cooking time in min.	Observations
Apple Crumble	Ovenproof dish	2 (3)	390 (200)		35 - 40	Apple casserole with streusel, also tastes very good when made with berries or mirabelles.
		2 (3)	390 (200)	---	25 - 30	For soft types of apples.
		2 (3)	390 (200)	---	25 - 30	For firm types of apples.
Baked apples	Ovenproof dish	2 (3)	375 - 390 (190 - 200)		20 - 30	Recommendation: use cooking apples, e.g. Boskop. These are especially well-suited for cooking and baking. Summer variant: fill with ricotta, lemon, honey, cardamom, vanilla, and pine nuts.
Compote	Glass / grill tray	2 (3)	320 - 355 (160 - 180)		30 - 40	e.g. apricots or assorted berries
		2 (3)	390 (200)	---	30 - 40	Do not add any liquid, stir several times. Season with honey, fresh vanilla or cinnamon.
Clafouti	Ovenproof dish	2 (3)	375 (190)		30 - 35	French dessert: classic with cherries, also tastes very good when made with berries or mirabelles.
		2 (3)	390 (200)		55	No need to preheat; do not open appliance door.
Sweet bake	Ovenproof dish	2 (3)	320 - 355 (160 - 180)		30 - 40	e.g. semolina, quark or rice pudding
Bread pudding, cherry cake	Ovenproof dish	2 (3)	300 (150)		50 - 55	e.g. with cherries or apricots

Dish	Accessories	Level	Temperature in °F (°C)	Type of heating	Cooking time in min.	Observations
Crepes with quark filling	Ovenproof dish	2 (3)	355 - 375 (180 - 190)	✚	8 - 10	Austrian specialty: pancakes, filled with quark and raisins, topped with cream and baked.
Meringue	Baking tray + grease-proof paper	2 (3)	210 (100)	✚	150	Spread out as flat as possible so that the mass dries all the way through.

Defrosting

- For this, use the "defrost" heating function.
- The defrost values specified are intended as a guide. The defrost time depends on the size, weight, and shape of the food to be defrosted: freeze your foods flat or separately. This shortens the defrost time.
- Slide the wire rack with the frozen food into the second shelf level (in the third shelf level if there are five shelf levels). Slide the grill tray underneath to catch any excess liquid.
- Remove the food from the packaging before defrosting.
- Only defrost the quantity that you need right away.
- Please consider: defrosted food will not last as long as frozen food and will spoil more quickly than fresh food. Prepare defrosted food immediately and cook it thoroughly.
- After half the defrost time has elapsed, turn the meat or fish. Separate defrosted food in pieces, e.g. berries or pieces of meat. Fish does not have to defrost all the way; it is sufficient if the surface is soft enough to take up the spices.

- The oven is not suited for defrosting whole chickens and roasts; this takes a long time. It is much faster to defrost such foods in the steam oven.

WARNING

Health risk!

When defrosting food from animal sources, you must remove the liquid that escapes during defrosting. It must never come into contact with other food. Bacteria could be transferred.

Slide the glass/grill tray under the food. Pour away the excess liquid collected from the meat and poultry. Then clean the sink and rinse with plenty of water. Clean the glass/grill tray in hot soapy water or in the dishwasher.

After defrosting, operate the oven for 15 minutes using Hot air at 355°F (180°C).

Dish	Accessories	Level	Temperature in °F (°C)	Type of heating	Cooking time in min.	Observations
Berries (1.1 lb / 500 g)	Glass / grill tray	2 (3)	120–130 (50–55)	* ◊	25 - 30	
Vegetables (1.1 lb / 500 g)	Glass / grill tray	2 (3)	120–130 (50–55)	* ◊	30 - 50	The defrosting time depends on the portioning. Small vegetables such as peas and beans defrost faster than blocks of spinach or whole cauliflower.
Chicken legs (0.4 lb / 200 g each)	Wire rack	2 (3)	120–130 (50–55)	* ◊	45 - 50	
Fish fillet (0.3 lb / 150 g each)	Wire rack	2 (3)	115–120 (45–50)	* ◊	45 - 50	
Prawns	Wire rack	2 (3)	115–120 (45–50)	* ◊	20 - 25	

Preserving

- If possible, cook food immediately after purchase or harvesting. Longer storage decreases the vitamin content and can cause spoilage.
- Only use fruit and vegetables in good condition.
- The oven is not suited for preserving meat.
- Check and clean the canning jars, rubber rings, clamps, and springs carefully.
- Place the canning jars in a heat-resistant container with water. Make sure that they do not touch. The water level must reach at least three quarters of the way up to the top of the contents of the jars.
- Open the cooking compartment door after the cooking time has elapsed. Do not remove the canning jars from the cooking compartment until they have cooled down completely.
- Store the preserves in a cool, dark and dry place, e.g. in a pantry. Once the jars have been opened, use the contents up quickly and store in the refrigerator.

Dish	Accessories	Level	Temperature in °F (°C)	Type of heating	Cooking time in min.	Observations
Fruit	Wire rack	1 (2)	300–320 (150–160)	---	35 - 40	in closed canning jars
Vegetables	Wire rack	1 (2)	375–390 (190–200)	---	60 - 120	in closed canning jars

Disinfecting

- Before canning, the jars should be disinfected in the oven in order to prevent spoilage. Only this way is it possible to store canned goods for a longer time and outside the refrigerator.
- Disinfect empty jars at 212°F (100°C) hot air for at least 20 minutes. The lids and seals for the jars can be disinfected simultaneously in boiling water so that they do not dry out in the dry heat in the oven.

Dish	Accessories	Level	Temperature in °F (°C)	Type of heating	Cooking time in min.	Observations
Disinfecting	Wire rack	2 (3)	212 (100)	✦	20 - 25	Canning jars, baby bottles

Drying

- Drying is a preservation method with which, through the feeding in of dry heat, up to 50% of the liquid in food is removed. At the same time, the flavor becomes more intense.
- The thicker the food is, the longer the drying process takes. Drying is the fastest and most energy-saving method if you want to cut food into slices.
- Place the prepared food on a roasting dish or tray covered with greaseproof paper. During the drying process, turn the food every now and then.
- The duration depends on the thickness of the food and the natural moisture in the food since drying tomatoes takes longer than drying mushrooms.
- If you would like to dry on two levels simultaneously, use levels 1 and 3 (or 2 and 4).

Dish	Accessories	Level	Temperature in °F (°C)	Type of heating	Cooking time in hours	Observations
Sliced mushrooms	Wire rack + greaseproof paper	2 (3)	120 - 140 (50 - 60)	✦	3 - 4	
Apple rings	Wire rack + greaseproof paper	2 (3)	160 (70)	✦	5 - 8	



Dish	Accessories	Level	Temperature in °F (°C)	Type of heating	Cooking time in hours	Observations
Quartered tomatoes	Wire rack + greaseproof paper	2 (3)	140 - 160 (60 - 70)	✿	7 - 8	Remove the core from the tomatoes; otherwise the drying time is longer.
Herbs	Wire rack + greaseproof paper	2 (3)	120 - 140 (50 - 60)	✿	1½ - 2	e.g. chives, parsley, sage

Baking stone

- You will need a baking stone and heating element – these are optional accessories.
- Whether you are baking crispy pizza or fresh bread, with the baking stone, you will achieve results that are comparable to, or even exceed, those that you would get from a massive stone oven because you are able to precisely control the baking temperature.
- Depending on the size, you can also place several pizzas, rolls or other baked goods on the baking stone at the same time.
- You can bake several pizzas in succession. This may increase the baking time per pizza by approx. 1 - 3 minutes.
- When baking bread, we recommend that you use the core temperature sensor. Wait 10 - 15 minutes after baking has begun before inserting the core temperature sensor into the thickest part of the bread. The sensor measures the internal temperature of the baked goods and switches the oven off when the set core temperature has been reached.
- When dough is baked, it needs to be able to expand without the surface breaking apart. This can be achieved by pricking it several times with a fork or by making a cut with a knife.
- The temperatures and times given in the cooking table are guideline values. Always follow the manufacturer's instructions for pre-cooked and frozen products.

Dish	Accessories	Level	Temperature in °F (°C)	Type of heating	Cooking time in min.	Comments
Rolls, fresh (1.7 oz /50 g each)	Baking stone	1	480/390* (250/200*)	☰	15-20	
Flatbread	Baking stone	1	140 (210)	☰	15	Cooking time depends on the size and thickness of the flatbread
Focaccia	Baking stone	1	140 (210)	☰	15	Top with various ingredients, e.g. herbs, sea salt, olives, anchovies, onions, ham, tomatoes, or cheese.
Multi-grain bread	Baking stone	1	345 (175)	☰	45	
Sourdough bread	Baking stone	1	480/390* (250/200*)	☰	50-60	
Olive-tomato bread	Baking stone	1	345 (175)	☰	45	
Pizza, fresh	Baking stone	1	525 (275)	☰	5-8	The cooking time varies depending on the type and thickness of the dough and topping.
Pizza, frozen	Baking stone	1	445 (230)	☰	8-10	The cooking time varies depending on the thickness of the dough. Observe the manufacturer's instructions.

* Pre-heat the appliance to the specified temperature. Turn the temperature down when placing the food in the oven.

Dish	Accessories	Level	Temperature in °F (°C)	Type of heating	Cooking time in min.	Comments
Tarte flambée, fresh	Baking stone	1	570 (300)		3-4	Recipe tip: Traditional or with goat's cheese, Parma ham, figs and spring onions.
Tarte flambée, frozen	Baking stone	1	480 (250)		4-5	

* Pre-heat the appliance to the specified temperature. Turn the temperature down when placing the food in the oven.

Roasting dish

- You will need a roaster, pull-out system and heating element – these are optional accessories.
- In the roasting dish, you can also braise large pieces of meat easily and cook large quantities.
- Food is easy to prepare and can be kept warm in the oven. Your kitchen will look clean and tidy, the cooktop will not be dirty, and there will be fewer cooking odors because the dish was cooked in the oven.
- The non-stick coating enables you to roast using very little fat.
Tip: Instead of adding the fat to the roasting dish, oil the meat. This ensures that the heat is transferred directly to the meat.
- Cooking liquids reduce down quickly. Make sure there is always sufficient cooking liquid. For a cooking time of 30 minutes, add approx. ½ l liquid.
- When roasting in a sauce, always ensure the sauce remains runny and add cooking liquid.
- In addition, follow the instructions in the instruction manual for the roasting dish.

Dish	Accessories	Level	Temperature in °F (°C)	Type of heating	Cooking time in min.	Observations
Chicken breast	Roasting dish	1	390 (200)	<input type="checkbox"/>	Searing + 15 - 20	Before inserting the food, also heat the roasting dish with the roasting function. Then insert the core temperature sensor.
Beef goulash	Roasting dish	1	430/265–285* (220/130–140*)	<input type="checkbox"/>	Searing + 60 - 120	Sear onions and meat; use the roasting setting for this. Pour in liquid and turn heat down, depending on the type of meat, cook for 60 - 120 minutes.
Ossobuco	Roasting dish	1	430/285* (220/140*)	<input type="checkbox"/>	Searing + 60 - 90	Sear meat and vegetables; use the roasting setting for this. Pour in liquid and turn heat down, cook covered for 60 - 90 minutes. Turn once.
Viennese boiled beef	Roasting dish	1	430/265* (220/130*)	<input type="checkbox"/>	Searing + 210 - 240	Sear halved onions, add vegetables briefly and fill up with liquid. Bring to a boil, season, and add beef. The meat should be completely covered with liquid. Put roasting lid on and continue cooking at 265°F (130°C).
Venison ragout	Roasting dish	1	430/265 - 285* (220/130 - 140*)	<input type="checkbox"/>	Searing + 60 - 100	Sear meat and other ingredients; use the roasting setting for this. Pour in liquid and turn heat down, depending on the type of meat and size of the pieces of meat, cook for 60 - 100 minutes.

** Brown the meat at high temperature, switch back to a lower temperature for further cooking.

Dish	Accessories	Level	Temperature in °F (°C)	Type of heating	Cooking time in min.	Observations
Roulades	Roasting dish	1	430/250* (220/120*)	<input type="checkbox"/>	Searing + 60 - 90	Sear roulades portion by portion; use the roasting setting for this.
Tortillas	Roasting dish	1	345 (175)	<input type="checkbox"/>	Searing + 10 - 15	Sear all ingredients but for the eggs in the roasting dish, then pour the eggs over the top and continue cooking until the tortilla is firm.
Farmers' omelette	Roasting dish	1	345 (175)	<input type="checkbox"/>	Searing + 10 - 15	Sear all ingredients but for the eggs in the roasting dish, then pour the eggs over the top and continue cooking until the farmers' omelette is firm.
Stuffed peppers, vegetarian	Roasting dish	1	390 (200)	<input type="checkbox"/>	30	Recipe tip: fill with cooked rice, Eibly wheat or lentils and onions, cheese, herbs and spices.
Chili con carne	Roasting dish	1	430/265* (220 / 130*)	<input type="checkbox"/>	Searing + 60 - 90	

** Brown the meat at high temperature, switch back to a lower temperature for further cooking.

Acrylamide in foodstuffs

Which foods are affected?

Acrylamide is mainly produced in grain and potato products that are heated to high temperatures, such as chips, fries, toast, rolls, bread, fine baked goods (cookies, gingerbread, Christmas spice cookies).

Tips for keeping acrylamide to a minimum when preparing food

General	Keep cooking times as short as possible. Cook food until it is golden brown, but not too dark. Large, thick pieces of food contain less acrylamide.
Baking	With hot air at max. 355° F (180 °C).
Cookies	Egg or egg yolk reduces the production of acrylamide. Spread out a single layer evenly on the baking tray.
Oven French fries	Cook at least 400 g at once on a baking tray so that the fries do not dry out.

Gaggenau
BSH Home Appliance Corporation
1901 Main Street, Suite 600
Irvine, CA 92614
1-877-442-4436

www.gaggenau.com/us
© 2020 BSH Home Appliances

Gaggenau Hausgeräte GmbH
Carl-Wery-Straße 34
81739 München
GERMANY



9001453703 (001016)
en-us

GAGGENAU