

Gaggenau

Use and care manual

BS 470/471 612

BS 474/475 612

BS 484/485 612

Combi-steam oven

Table of Contents

▲ Safety Definitions	3	Activating the appliance	19
IMPORTANT SAFETY INSTRUCTIONS	4	Standby	19
Proper Installation and Maintenance	4	Activate appliance	19
Fire Safety	5	Operating the appliance	19
Burn Prevention	6	Oven interior	19
Child Safety	7	Inserting accessories	19
Cleaning Safety	8	Turning on	20
Cookware Safety	8	Turning off	20
Proposition 65 Warning	9	Steam injection	20
Causes of damage	10	Steam removal	20
Environmental protection	10	After every use	21
Saving energy	10	Safety shut-off	21
Familiarizing yourself with your appliance	11	Timer functions	21
Combi-steam oven	11	Launching the timer menu	21
Water tank for descaling program	12	Timer	21
Displays and controls	12	Stopwatch	22
Symbols	12	Cooking time	22
Colors and display	13	End of cooking time	23
Automatic door opening	13	Sabbath mode and Yom Tov mode	24
Standby	13	Sabbath mode	24
Activate appliance	13	Yom Tov mode	25
Additional information i and i [®]	14	Panel Lock	26
Cooling fan	14	Activating the child lock	26
Drying of oven cavity	14	Deactivating the child lock	26
Program selection positions	14	Automatic programs	26
Accessories	16	Information on the settings	26
Special accessories	16	Selecting a dish	26
Before using the appliance for the first time	17	Applying settings for dishes	27
Setting the language	17	Calling up the last automatic programs used	27
Setting the time format	17	Personal recipes	28
Setting the time	17	Recording a recipe	28
Setting the date format	17	Programming a recipe	28
Setting the date	17	Entering a name	29
Setting the temperature unit	17	Starting a recipe	29
Setting the water filter	17	Change recipe	29
Setting water hardness	18	Deleting a recipe	29
Completing initial set-up	18	Core temperature probe	30
Cleaning the door panel	18	Inserting the core temperature probe into the food	30
Cleaning accessories	18	Setting the core temperature	31
Heating up the appliance	18	Core temperature guidelines	32
Water filter	18		
Operation with or without water filter	18		
Change water filter	18		

Home Connect	33
Setting Up	33
Remote Start	34
Home Connect settings	35
Remote Diagnostics	35
Information on Data Protection	36
Declaration of Conformity	36
Wi-Fi® Module	36
Basic settings	37
Cleaning and maintenance	40
Cleaning agents	40
Cleaning program	41
Drying program	43
Descaling program	43
Removing the wire racks	45
Troubleshooting	46
Power cut	47
Demo mode	47
Customer service	48
Tables and tips	48
Vegetables	49
Fish	50
Fish – low-temperature steaming	51
Meat – cooking at higher temperatures	52
Meat/poultry – low-temperature cooking	53
Poultry	54
Sous-vide cooking	55
Broiling	58
Side dishes	59
Desserts	60
Other	61
Baked goods	61
Dough proving (leaving to rise)	63
Refreshing (warming up)	64
Defrosting	64
Preserving	65
Extracting juice (soft fruits)	66
Preparing yoghurt	66
Preparing bulky food	66
Acrylamide in foodstuffs	67

Safety Definitions

WARNING

This indicates that death or serious injuries may occur as a result of non-observance of this warning.

CAUTION

This indicates that minor or moderate injuries may occur as a result of non-observance of this warning.

NOTICE

This indicates that damage to the appliance or property may occur as a result of non-compliance with this advisory.

Note: This alerts you to important information and/or tips.

Additional information on products, accessories, replacement parts and services, as well as the Use and care manual and the Installation instructions can be found at www.gaggenau.com and in the online shop www.gaggenau.com/zz/store

IMPORTANT SAFETY INSTRUCTIONS

READ AND SAVE THESE INSTRUCTIONS

IMPORTANT SAFEGUARDS

SAVE THESE INSTRUCTIONS.

WARNING

When properly cared for, your new appliance has been designed to be safe and reliable. Read all instructions carefully before use. These precautions will reduce the risk of burns, electric shock, fire, and injury to persons. When using kitchen appliances, basic safety precautions must be followed, including those in the following pages.

Proper Installation and Maintenance

Have the installer show you the location of the circuit breaker or fuse. Mark it for easy reference.

This appliance must be properly installed and grounded by a qualified technician. Connect only to properly grounded outlet. Refer to Installation Instructions for details.

This appliance is intended for normal family household use only. It is not approved for outdoor use. See the Statement of Limited Product Warranty. If you have any questions, contact the manufacturer.

Do not store or use corrosive chemicals, vapors, flammables or nonfood products in or near this appliance. It is specifically designed for use when heating or cooking food. The use of corrosive chemicals in heating or cleaning will damage the appliance and could result in injury.

Do not operate this appliance if it is not working properly, or if it has been damaged. Contact an authorized servicer.

Do not obstruct oven vents.

Do not repair or replace any part of the appliance unless specifically recommended in this manual. Refer all servicing to an authorized servicer.

WARNING

Risk of burns!

To avoid risk of injury, turn off the interior light before cleaning the oven to allow the bulbs to cool down. The bulbs can become very hot when switched on. Keep the light off while cleaning the oven.

IMPORTANT SAFETY INSTRUCTIONS

READ AND SAVE THESE INSTRUCTIONS

WARNING

Make sure the appliance and lights are cool and power to the appliance has been turned off before replacing the light bulb(s). Failure to do so could result in electrical shock or burns. The lenses (if equipped) must be in place when using the appliance. The lenses (if equipped) serve to protect the light bulb from breaking. The lenses (if equipped) are made of glass. Handle carefully to avoid breaking. Broken glass can cause an injury.

WARNING

Light socket is live when door is open if main power supply is not turned off.

WARNING

Risk of short circuiting! Never allow electrical appliance cords to become pinched in the hot appliance door. The cord's insulation can melt.

Fire Safety

WARNING

NEVER cover any slots, holes or passages in the oven bottom or cover an entire rack with materials such as aluminum foil. Doing so blocks air flow through the oven. Aluminum foil linings may also trap heat, causing a fire hazard.

If materials inside an oven or warming drawer should ignite, keep door closed. Turn off the appliance and disconnect the circuit at the circuit breaker box.

WARNING

Use this appliance only for its intended use as described in this manual. NEVER use this appliance as a space heater to heat or warm the room. Doing so may result in overheating the appliance. Never use the appliance for storage.

Always have a working smoke detector near the kitchen.

In the event that personal clothing or hair catches fire, drop and roll immediately to extinguish flames.

Have an appropriate fire extinguisher available, nearby, highly visible and easily accessible near the appliance.

Smother flames from food fires other than grease fires with baking soda. Never use water on cooking fires.



IMPORTANT SAFETY INSTRUCTIONS

READ AND SAVE THESE INSTRUCTIONS



WARNING

TO REDUCE THE RISK OF INJURY TO PERSONS IN THE EVENT OF A GREASE FIRE, OBSERVE THE FOLLOWING:

1. **SMOTHER FLAMES** with a close-fitting lid, cookie sheet, or metal tray, then turn off the burner. **BE CAREFUL TO PREVENT BURNS.** If the flames do not go out immediately, **EVACUATE AND CALL THE FIRE DEPARTMENT.**
2. **NEVER PICK UP A FLAMING PAN** – You may be burned.
3. **DO NOT USE WATER**, including wet dishcloths or towels – a violent steam explosion will result.
4. Use an extinguisher **ONLY** if:
 - You know you have a Class ABC extinguisher, and you already know how to operate it.
 - The fire is small and contained in the area where it started.
 - The fire department is being called.
 - You can fight the fire with your back to an exit.

Burn Prevention

DO NOT TOUCH HEATING ELEMENTS OR INTERIOR SURFACES OF OVEN - Heating elements may be hot even though they are dark in color. Interior surfaces of an oven become hot enough to cause burns. During and after use, do not touch, or let clothing, potholders, or other flammable materials contact heating elements or interior surfaces of oven until

they have had sufficient time to cool. Other surfaces of the appliance may become hot enough to cause burns. Among these surfaces are oven vent openings, surfaces near these openings and oven doors.

Exercise caution when opening the appliance. Standing to the side, open the door (or drawer) slowly and slightly to let hot air and/or steam escape. Keep your face clear of the opening and make sure there are no children or pets near the unit. After the release of hot air and/or steam, proceed with your cooking. Keep doors shut unless necessary for cooking or cleaning purposes. Do not leave open doors unattended.

Do not heat or warm unopened food containers. Build-up of pressure may cause the container to burst and cause injury.

Always place oven racks in desired location while oven is cool. Always use oven mitts, when the oven is warm. If a rack must be moved while oven is hot, do not let potholder contact the heating elements.



CAUTION

To avoid possible injury or damage to the appliance, ensure rack is installed exactly per installation instructions and not backwards or upside down.

Always use dry potholders. Moist or damp potholders on hot surfaces may result in burns from steam. Do not let potholder

IMPORTANT SAFETY INSTRUCTIONS

READ AND SAVE THESE INSTRUCTIONS

touch hot heating elements. Do not use a towel or other bulky cloth.

WARNING

Scalding hazard!

Movement when opening the appliance door and when removing the cookware can cause hot liquid to spray out. Do not stand too close to the appliance when opening it. Open appliance door carefully. Remove cookware carefully. Keep children away.

Secure all loose garments, etc. before beginning. Tie long hair so that it does not hang loose, and do not wear loose fitting clothing or hanging garments, such as ties, scarves, jewelry, or dangling sleeves.

Use caution when cooking foods with high alcohol content (e.g. rum, brandy, bourbon) in the oven. Alcohol evaporates at high temperatures. There is a risk of burning as the alcohol vapors may catch fire in the oven. Use only small quantities of alcohol in foods, and open the oven door carefully.

WARNING

Risk of scalding!

Hot liquid may spill over the sides of cooking accessories when they are removed from the oven cavity. Carefully remove cooking accessories with oven mitts.

WARNING

Risk of scalding!

Hot steam can escape when you open the appliance door. Steam is not visible at certain temperatures. Do not stand too close to the appliance when opening it. Open the appliance door with caution. Keep children away.

WARNING

Risk of burns!

Hot steam can leak during operation. Do not touch the ventilation openings. Keep children away.

Child Safety

When children become old enough to use the appliance, it is the responsibility of the parents or legal guardians to ensure that they are instructed in safe practices by qualified persons.

Do not allow anyone to climb, stand, lean, sit, or hang on any part of an appliance, especially a door, warming drawer, or storage drawer. This can damage the appliance, and the unit may tip over, potentially causing severe injury.

Do not allow children to use this appliance unless closely supervised by an adult. Children and pets should not be left alone or unattended in the area where the appliance is in use. They should never be allowed to play in its vicinity, whether or not the appliance is in use.

IMPORTANT SAFETY INSTRUCTIONS

READ AND SAVE THESE INSTRUCTIONS

CAUTION

Items of interest to children should not be stored in an appliance, in cabinets above an appliance or on the backsplash. Children climbing on an appliance to reach items could be seriously injured.

Cleaning Safety

Risk of severe burns! Do not clean the appliance immediately after turning it off. The water in the evaporator dish is still hot. Wait until the appliance has cooled down.

Keep oven free from grease build up.

WARNING

Risk of injury!
Scratched glass in the appliance door can burst. Do not use any glass scrapers or strong or abrasive cleaning agents.

WARNING

Risk of electrical shock!
Moisture entering the appliance can cause an electrical shock. Don't use a high-pressure cleaner or steam cleaner.

CAUTION

Do not remove the wax plugs from the opening of the cleaning cartridge. Do not use any other detergents. Do not use damaged cartridges.

Never heat the appliance up if a cartridges has been inserted.

WARNING

To prevent the cleaner from coming into contact with the skin or eyes, do not remove the locking cap from a spent cartridge.

Cookware Safety

Do not place food directly on oven bottom.

Follow the manufacturer's directions when using cooking or roasting bags.

WARNING

Risk of electric shock!
Use of a wrong core temperature probe can damage the insulation. Use only the core temperature probe intended for this appliance.

Ovenware must be heat and steam resistant. Silicone baking pans are not suitable for Combination mode.

When using Steam mode with a perforated cooking pan, always slide the



IMPORTANT SAFETY INSTRUCTIONS

READ AND SAVE THESE INSTRUCTIONS

baking pan underneath it. The pan will catch any drippings.

Care must be taken to prevent aluminum foil and meat probes from contacting the heater elements.

The oven bottom and the evaporator dish must always remain clear. Always place ovenware on the rack or in the perforated cooking pan.

Proposition 65 Warning:

This product may contain a chemical known to the State of California, which can cause cancer or reproductive harm. Therefore, the packaging of your product may bear the following label as required by California:

STATE OF CALIFORNIA PROPOSITION 65 WARNING:

 **WARNING**

Cancer and Reproductive Harm - www.P65Warnings.ca.gov

Causes of damage

NOTICES:

- Do not place anything directly on the oven floor. Do not line it with aluminum foil. Heat build-up can damage the appliance.
- The oven bottom should always remain clear. Always place dishes in a perforated baking pan or on a rack.
- We recommend you install a descaling system for hard mains water. You can inquire with your waterworks to obtain information about your mains water.
- Aluminum foil may not contact the door pane in the oven. This can cause permanent discoloration of the door pane.
- Dishes must be heat and steam resistant. Silicone baking dishes are not suited for combination operation with steam.
- Use only original accessories in the oven interior. Rusting material (such as serving platters or knives and forks) can cause corrosion in the oven interior.
- Use original small parts (e.g. knurled nuts) only. Reorder small parts through out spare parts service if these should be lost..
- Dripping liquids: When steaming with a perforated pan, always place the unperforated pan underneath to collect dripping liquids.
- Do not leave moist groceries in a closed oven for an extended period of time. It can lead to corrosion inside the oven.
- Salt, spicy sauces (e.g. ketchup or mustard) or salted dishes (e.g. cured roast) contain chlorides and acids. These corrode the surfaces of stainless steel. Always remove residues immediately.
- Fruit juice can leave stains in the oven. Always remove fruit juice immediately when safe to touch, and wipe up first with a damp and then a dry cloth.
- Your appliance's oven interior consists of high-grade stainless steel. Corrosion can occur in the oven interior if it is not cared for properly. Observe the care and cleaning notes in the operating instructions. After every use, clean the oven interior straight after the appliance has cooled down. After cleaning, dry the oven interior with the drying program.
- Do not detach the door seal. The appliance door will no longer close properly if the door seal is damaged. Adjoining furniture frontages may be damaged. Have the door seal replaced.

Environmental protection

Unpack the appliance and dispose of the packaging in an environmentally friendly manner.

Saving energy

- Open the appliance door as little as possible while cooking.
- Use dark, black-painted or enamelled baking forms. These absorb the heat particularly well.
- It is best to bake several cakes in succession. The steam oven is still warm. This shortens the baking time for the second cake. You can also slide in two loaf tins next to each other.
- For longer cooking times, you can switch off the steam oven 10 minutes before the end of the cooking time and you can use the residual heat to finish cooking.
- When steaming, you can cook simultaneously on several levels. If dishes require different cooking times, insert the dishes that require the longest time first.

Familiarizing yourself with your appliance

You will get to know your new appliance here. We explain the control panel and the individual controls to you. You are informed about the oven interior and accessories.

Combi-steam oven

These instructions apply to different versions of the appliance. Slight deviations are possible depending on the appliance type.

Operation is identical for all appliance versions.

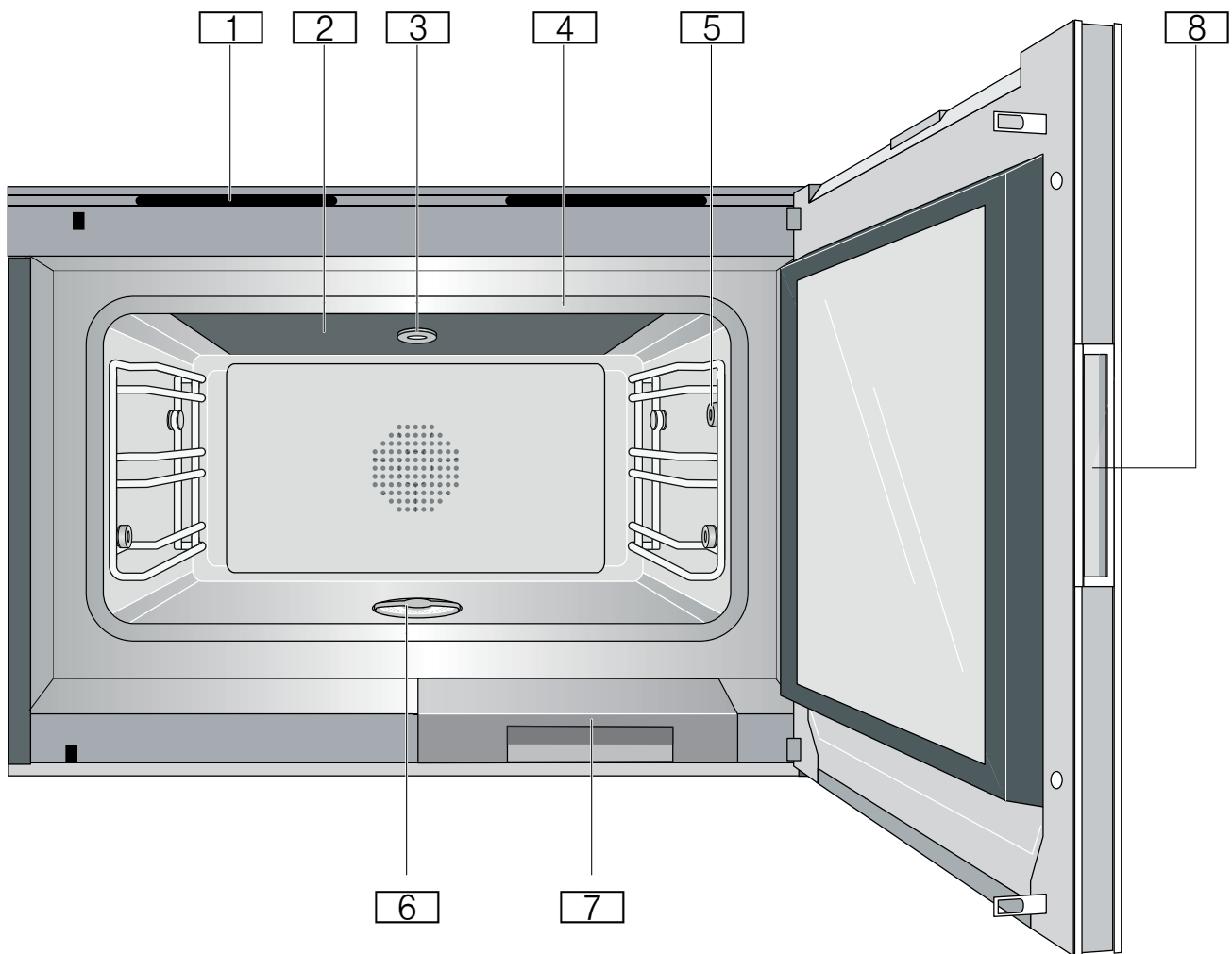

- | | |
|---|------------------------------------|
| 1 | Ventilation slots |
| 2 | Glass ceramic broil surface |
| 3 | Socket for cleaning cartridge |
| 4 | Door seal |
| 5 | Socket for core temperature sensor |
| 6 | Drainage sieve |
| 7 | Water tank for descaling program |
| 8 | Recessed handle |

Do not obstruct oven vents.

NOTICE

Do not place food directly on oven bottom.

Water tank for descaling program

Your appliance is equipped with a water tank with a maximum capacity of 3.5 pints (1.7 liters). If you open the appliance door, you can see the water tank for the descaling program. The lid can be removed for cleaning.

→ "Descaling program" on page 43

Displays and controls

These instructions apply to different versions of the appliance. Slight deviations are possible depending on the appliance type.

Operation is identical for all appliance versions.

Operator control on the appliance top

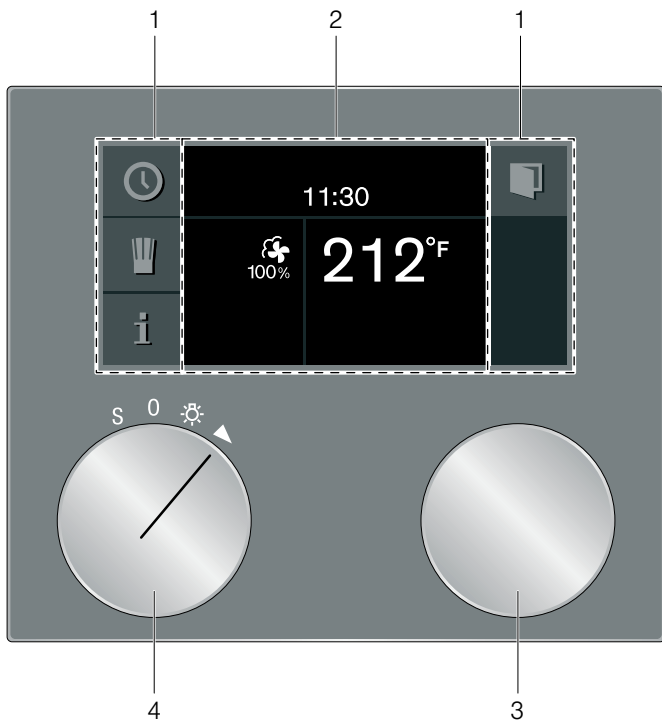



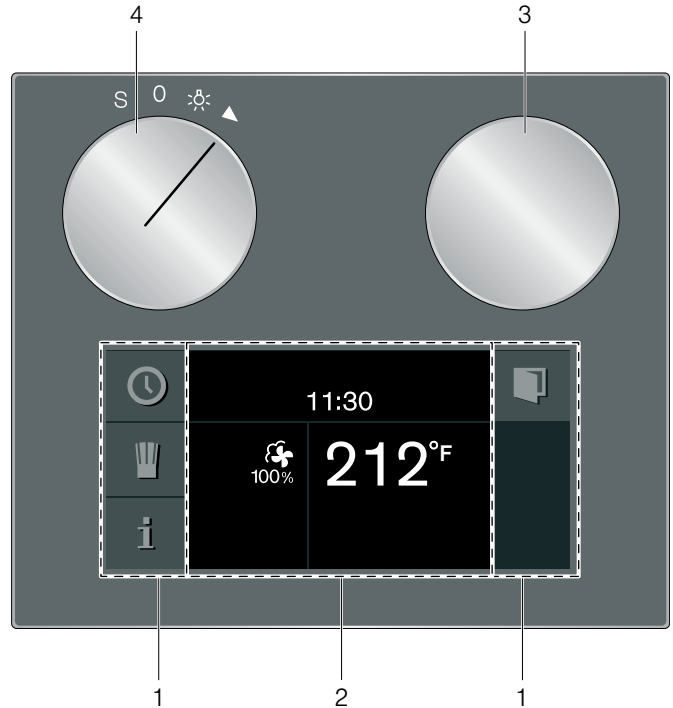









Operator control on the appliance bottom



1	Control panel	These areas are touch-sensitive. Touch a symbol to select the applicable function.
2	Display	The display shows current settings and options, for example.
3	Rotary selector	With the rotary selector you can select the temperature and make other settings.
4	Function selector	The function selector is used to select the type of heating, the cleaning function or the basic settings.

Symbols

Symbol	Function
▶	Start
■	Stop
	Pause/end
X	Cancel
C	Delete
✓	Confirm/save settings
>	Selection arrow
📄	Open appliance door
i	Launching additional information
⏩	Quick heating with status indicator
☕	Calling up automatic programs or individual recipes
rec	Recording a menu
↘	Edit settings

	Enter a name
	Delete letters
	Child lock
	Launching the timer menu
	Launching the Sabbath mode
	Demo mode
	Core temperature probe
	Misting start
	Misting stop
	Starting steam removal
	Stopping steam removal
	Network connection (Home Connect)

Colors and display

Colors

The various colors serve to guide you in the various adjustment situations.

Orange	First settings Main functions
Blue	Basic settings Cleaning
White	Adjustable values

Presentation

The presentation of symbols, values or the entire display changes depending on the situation.

Zoom	The display of the setting you are just changing is enlarged. Just before it elapses, a duration that is just elapsing is enlarged (e.g. the last 60 seconds in the case of timers).
Minimized display screen	After a short time, the display screen is minimized and only the most important things are displayed. This function is the default and can be modified in the basic settings.

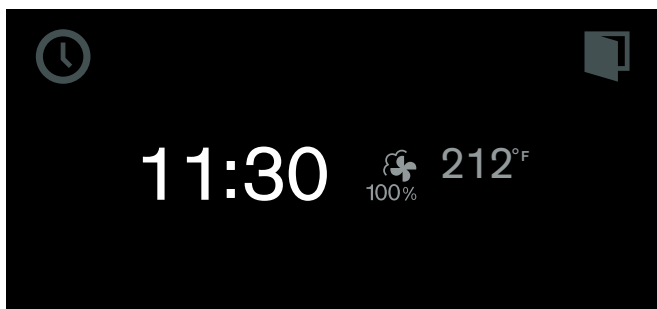

Automatic door opening

When you touch the  symbol, the appliance door springs open and you can open it fully with the handle recess at the side.

Automatic door opening does not work when the child lock is activated or in the event of a power failure. You can open the door manually with the handle recess at the side.

Standby

The appliance switches to standby mode if no function is set or the childproof lock is activated.

The brightness of the control panel is dimmed in standby mode.

Notes

- Different things can be displayed in standby mode. The default setting is the GAGGENAU logo and the time.
- The brightness of the display depends on the vertical viewing angle.
- You can change the display and the brightness at any time in the basic settings. → *"Basic settings" on page 37*

Activate appliance

In order to exit standby mode, you can either

- Set the function selector,
- Touch a control panel,
- or open or close the door.

Now you can set the desired function. Read the appropriate chapters to learn how to set functions.

Notes

- If "Standby screen = off" is selected in the basic settings, you have to turn the function selector to exit the standby mode.
- The standby display appears again if you have not made any settings for a long while after activation.
- The appliance rinses automatically after each cooking process. The appliance rinses automatically before each cooking process, if it has not been operated for more than 100 hours.
- The cooking compartment lighting goes out after a little while if the door is open.

Additional information i and i[Ⓢ]

By touching the **i** symbol, you can call up additional information. For example, information on the type of heating set or on the current temperature of the cooking compartment.

Note: During continuous operation after heating up, slight deviations in temperature are normal.

The **i[Ⓢ]** symbol appears for important information and indicates that an action is required. Important information on safety and operating status is also occasionally displayed automatically. These messages disappear automatically after a few seconds, or must be confirmed with ✓.

With Home Connect messages, the Home Connect status additionally appears in the **i[Ⓢ]**. You will find more information about this in the section entitled → "Home Connect" on page 33.

Cooling fan

Your appliance has a cooling fan. The cooling fan switches on during operation. The warm air escapes above the door.

After removing cooked food, keep the door closed until the appliance cools down. The appliance door must not be left ajar, as adjoining kitchen furniture may be damaged. The cooling fan continues to run for a while and then switches off automatically.

⚠ CAUTION

Do not cover up the ventilation slots. Otherwise, the appliance will become overheated.







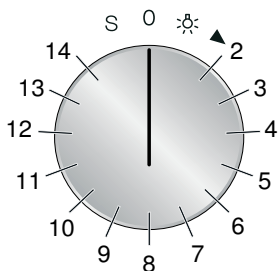



Drying of oven cavity





After operation with a steam function, the oven cavity is damp. The cooling fan and the fan wheel on the back wall of the oven cavity continue running for a while after the appliance is switched off and then switch off automatically. This may take up to 95 minutes. The appliance door must remain closed while the oven cavity is being dried.

Program selection positions



Position	Function/heating mode	Temperature	Application
0	"Off" position		
⚡	Light		Turn on the oven cavity light. Access to other functions, e.g. automatic programs, individual recipes, remote start (Home Connect).
2	Convection + 100% humidity	85 - 450° F (30 - 230°C) Default temperature 212° F (100 °C)	Steaming at 160 - 212° F (70 - 100°C): For vegetables, fish and side dishes. The food is completely enveloped by steam. Combination mode at 250 - 450° F (120 - 230°C): For puff pastry, bread and bread rolls. Convection and steam are combined.
3	Convection + 80% humidity	85 - 450° F (30 - 230°C) Default temperature 340° F (170 °C)	Combination mode: For puff pastry, meat and poultry. Convection and steam are combined.

Position	Function/heating mode	Temperature	Application
4	 Convection + 60% humidity	85 - 450° F (30 - 230°C) Default temperature 340° F (170 °C)	Combination mode: For yeast-risen baked goods and bread. Convection and steam are combined.
5	 Convection + 30% humidity	85 - 450° F (30 - 230°C) Default temperature 340° F (170 °C)	Cooking without added liquid: For baked goods. With this setting, no steam is generated. Any moisture escaping from the food remains in the oven cavity and prevents the food from drying out.
6	 Convection + 0% humidity	85 - 450° F (30 - 230°C) Default temperature 340° F (170 °C)	Convection: For cakes, biscuits and bakes. The fan in the back panel of the oven distributes the heat evenly throughout the oven cavity.
7	 Low-temperature cooking	85 - 200° F (30 - 90°C) Default temperature 160° F (70°C)	Low-temperature cooking for meat. Gentle slow cooking for a particularly tender result.
8	 Sous-vide cooking	125 - 200° F (50 - 95°C) Default temperature 140° F (60°C)	Cooking under a vacuum at low temperatures between 125 - 200° F (50 - 95°C) and 100% steam: Suitable for meat, fish, vegetables and desserts. A vacuum-sealing machine uses heat to hermetically seal the food in a special heat-resistant cooking bag. The protective envelope retains the nutrients and flavours.
9	 Full surface broil setting 1 + humidity	85 - 450° F (30 - 230°C) Default temperature 340° F (170 °C)	Broil mode with humidity: For bakes and gratins.
10	 Full surface broil setting 2 + humidity	85 - 450° F (30 - 230°C) Default temperature 340° F (170 °C)	Broil mode with humidity: For stuffed vegetables. The broil output is increased.
11	 Full surface broil + air recirculation	85 - 450° F (30 - 230°C) Default temperature 445° F (230 °C)	For au gratin dishes at the end of the cooking time at 450° F (230 °C). For broiling vegetable skewers and prawn skewers at 360° F (180 °C).
12	 Dough proofing	85 - 125° F (30 - 50 °C) Default temperature 100° F (38 °C)	Proofing: For yeast dough and sourdough. The dough rises considerably more quickly than at room temperature. Convection and steam are combined so that the surface of the dough does not dry out. The optimal temperature setting for yeast dough is 100° F (38 °C).
13	 Defrosting	100 - 140° F (40 - 60°C) Default temperature 115° F (45°C)	For vegetables, meat, fish and fruit. The moisture transfers the heat to the food, gently defrosting it without impairing its quality. The food does not dry out or lose its shape.
14	 Reheating	140 - 360° F (60 - 180°C) Default temperature 250° F (120 °C)	For cooked food and baked goods. Cooked food is gently reheated without affecting its quality. The steam ensures that the food does not dry out. Reheat plated meals at 250° F (120°C) and baked goods at 360° F (180°C).

Position	Function/heating mode	Temperature	Application
S	 Basic settings		Your appliance can be adjusted to your requirements in the basic settings.
	 Cleaning program		The cleaning program can be used to remove stubborn soil from the oven cavity.
	 Drying program		You can dry the oven cavity quickly, e.g. after cleaning, using the drying program.
	 Descaling program		The descaling program can be used to remove limescale from the appliance.
	 Water filter change		Change the water filter if a descaling system is installed.

Accessories

Use only the accessories included or obtainable from after-sales service. It has been specially adapted to your appliance. Make sure you always insert accessories into the interior the right way round.

Your appliance comes with the following accessories:

- 

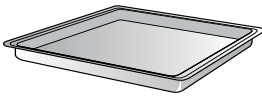
Rack
for cookware, cake pans and casseroles and for roasts
- 

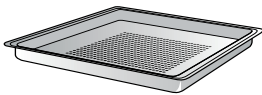
Stainless steel cooking container, unperforated, 1½" (40 mm) deep
For cooking rice, pulses and cereals, baking cakes on trays and catching dripping liquid when steaming
- 

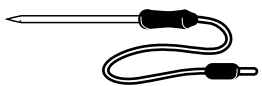
Stainless steel cooking container, perforated, 1½" (40 mm) deep
For steaming vegetables or fish, juicing berries and defrosting
- 

Core temperature probe
for precise preparation of meat, fish, poultry and bread
- 

Set with 4 cleaning cartridges

- BA 020 360 Stainless steel container, unperforated, 1½" (40 mm) deep, 1.3 gal (5 l)
- BA 020 370 Stainless steel container, perforated, 1½" (40 mm) deep, 1.3 gal (5 l)
- BA 020 380 Container, non-stick, unperforated, 1½" (40 mm) deep, 1.3 gal (5 l)
- BA 020 390 Container, non-stick, perforated, 1½" (40 mm) deep, 10 pint (5 l)
- CL S10 040 Set with 4 cleaning cartridges
- 17002490 Descaling tablets (set with four descaling tablets)
- GN 010 330 GN adapter (For use with GN cooking inserts and roasters)
- GN 114 130 Stainless steel cooking insert GN 1/3, unperforated, 1½" (40 mm) deep, 1.5 l
- GN 114 230 Stainless steel cooking insert GN 2/3, unperforated, 1½" (40 mm) deep, 3 l
- GN 124 130 Stainless steel cooking insert GN 1/3, perforated, 1½" (40 mm) deep, 1.5 l
- GN 124 230 Stainless steel cooking insert GN 2/3, perforated, 1½" (40 mm) deep, 3 l

Use the accessories only as indicated. The manufacturer assumes no liability for incorrect usage of the accessories.

Do not heat the non-stick cooking containers up to more than 445° F (230 °C). Use the non-stick cooking container only in the combi-steam oven.

Special accessories

You can order the following accessories from your specialist dealer:

- BA 010 301 Triple telescopic pull-out rack
- BA 030 300 Wire rack, with feet

Before using the appliance for the first time

In this chapter, you can find out what you must do before using your oven to prepare food for the first time. First read the section entitled → *"IMPORTANT SAFETY INSTRUCTIONS"* on page 4.

The appliance must be completely installed and connected.

After connecting the appliance to the power supply, the "Initial settings" menu will be displayed. Now you can now configure your new appliance for initial set-up.

Notes

- The "Initial settings" menu will appear only after the appliance has been connected to a power supply and switched on for the first time, or if the appliance has not been connected to a power supply for a number of days.

Once the appliance has been connected to a power supply, the GAGGENAU logo will appear first for approximately 30 seconds. The "Initial settings" menu will then appear automatically.

- You can change the settings at any time in the basic settings. → *"Basic settings"* on page 37

Setting the language

The default language appears in the display.

1. Select the desired display language with the rotary selector.
2. Confirm with ✓.

Setting the time format

the two possible formats 24h and AM/PM appear in the display. The default format is 24h.

1. Set the required format with the rotary selector.
2. Confirm with ✓.

Setting the time

The time appears in the display.

1. Set the required time with the rotary selector.
2. Confirm with ✓.

Setting the date format

The three possible formats D.M.Y, D/M/Y and M/D/Y appear in the display. The D.M.Y is the default.

1. Set the required format with the rotary selector.
2. Confirm with ✓.

Setting the date

The default date appears in the display. The day setting is already active.

1. Set the required day with the rotary selector.
2. Switch to the month setting with the > symbol.
3. Set the month with the rotary selector.
4. Switch to the year setting with the > symbol.
5. Set the year with the rotary selector.
6. Confirm with ✓.

Setting the temperature unit

The two possible units °C and °F will appear on the display. The default unit is °C.

1. Use the rotary selector to select the unit you require.
2. Press ✓ to confirm.

Setting the water filter

"Water filter" appears in the display. The default is "Available".

It is recommended to install a suitable descaling system if the water hardness exceeds 7° dH (carbonate hardness 5° dH).

1. Use the rotary selector to select "Available" (with water filter) or "Not available" (without water filter).
2. Confirm with ✓.
3. If water filter "Available" has been selected: "Water filter capacity" is shown in the display.
4. Turn the rotary selector to select the capacity of the filter cartridge (between 100 - 9000 liters). Refer to the instructions included with the filter cartridge.
5. Confirm with ✓.

Setting water hardness

"Water hardness" appears on the display.

Note: The water hardness display only appears if "Water filter - Not available" is selected.

1. Use the enclosed carbonate hardness test to check the mains water: Fill the measurement tube up to the 5 ml fill mark with tap water.
2. Add the indicator solution drop by drop until the color changes from purple to yellow.

Important: Count the drops and carefully turn the measuring tube after every single drop until the solution is thoroughly mixed in. The number of droplets corresponds to the water hardness.

3. Using the rotary selector, set the measured water hardness. The value 12 is set by default.
4. Press ✓ to confirm.

Completing initial set-up

"Initial set-up complete" will appear on the display.

Press ✓ to confirm.

The appliance will switch to standby mode and the standby display will appear. The appliance is now ready to use.

Cleaning the door panel

The door seal has been greased in the factory to make it leaktight. There may be traces of grease left on the door panel.

Clean the door panel with glass cleaner and a window cloth or microfibre cloth before using the appliance for the first time. Do not use glass scrapers.

Cleaning accessories

Before using accessories for the first time, thoroughly clean them with hot soapy water and a soft dish cloth.

Heating up the appliance

Make sure that there is no leftover packaging in the oven cavity.

To eliminate the new-appliance smell, heat up the empty appliance with the door closed. One hour with Convection ✪ + 60% humidity at 390° F (200 °C) is ideal.

Water filter

Operation with or without water filter

You can use the appliance with or without a water filter.

It is recommended to install a suitable descaling system if the water hardness exceeds 7° dH (carbonate hardness 5° dH).

Change water filter

Filter cartridges should be replaced regularly.

The capacity of the filter cartridge depends on the frequency of use of the appliance and your regional water hardness. A message will appear in the display to remind you when the filter needs to be replaced. Regardless of the actual amount of water filtered the filter cartridge needs to be changed after 12 months at the latest.

1. Set the function selector to **S**. Select "Water filter change" using the rotary selector.
2. The ☉ symbol is displayed. Confirm with ✓.
3. Change the water filter. Refer to the instructions included with the filter cartridge. Confirm with ✓.
4. "Select water filter capacity" is shown in the display. Confirm with ✓.
5. Turn the rotary selector to select the capacity of the filter cartridge (between 100 - 9000 liters). Confirm with ✓.

The water filter change is complete. Touch the ✓ symbol. The appliance is now ready for operation.

Activating the appliance

Standby

The appliance is in the standby mode when no function is set or the child lock is activated.

The control panel's brightness is reduced in the standby mode.

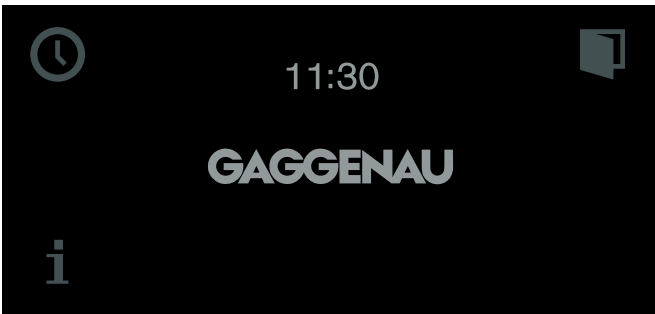

Notes

- Different displays can be shown in standby mode. The default setting is the GAGGENAU logo and the time. You can adjust the display using the "Standby screen" setting in the basic settings. → *"Basic settings" on page 37*
- The brightness of the display depends on the vertical viewing angle. You can adjust the display using the "Brightness" setting in the basic settings.

Activate appliance

In order to exit standby mode, you can either

- Set the function selector,
- Touch a control panel,
- or open or close the door.

Now you can set the desired function. Read the appropriate chapters to learn how to set functions.

Notes

- If "Standby screen = off" is selected in the factory setting, you must turn the function selector to exit the standby mode.
- The standby display appears again if you have not made any settings for a long while after activation.
- The cooking compartment lighting goes out after a little while if the door is open.

Operating the appliance

Oven interior

The oven cavity has three shelf positions. The shelf positions are counted from the bottom up.

Note: When steaming, defrosting, dough proofing and refreshing, you can use up to three insertion levels at the same time. You can only bake on one level, use level 2 when baking (or level 1 for higher cake tins). For very small baked goods, you can also use two levels, e.g. level 1 and level 3.

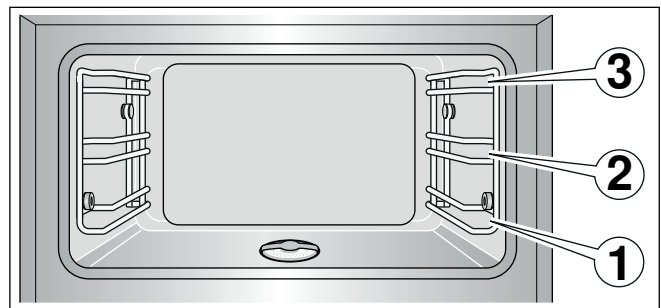

⚠ CAUTION

- Do not place anything on the cooking compartment floor. Do not cover it with aluminum foil. A build-up of heat could damage the appliance or cause injury. The oven cavity floor must always be kept clear. Always place ovenware in a perforated cooking container or on a wire rack..
 - Do not slide any accessories between the shelf positions, or they may tip.
-

Inserting accessories

The rack and the perforated cooking container feature a latching function. The latching function prevents tilting of accessories when pulling them out. You must insert accessories into the oven cavity correctly so that tilt protection will work. When removing accessories, you must raise them slightly.

When inserting the rack, make sure

- that the engaging lug (a) points upward
- that the rack's safety clip is at the rear and top.

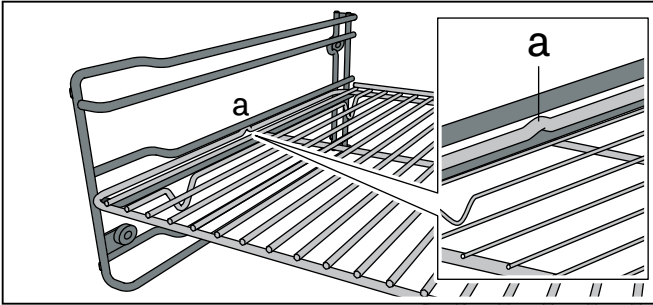

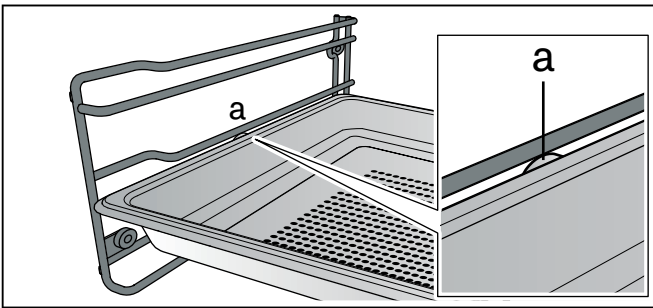

When pushing in the perforated cooking container, make sure that the engaging lug (a) points upwards.



Turning on

1. Use the function selector to set the type of heating. The selected heating type and suggested temperature appear on the display.
2. If you would like to change the temperature: Turn the rotary selector to set the desired temperature.

The preheat symbol  appears on the display. The bar shows the current preheat status. When the set temperature has been reached, a signal sounds and the  preheat symbol goes out.

Note: The temperature that has been set will be retained when you change to a different operating mode. The suggested temperature only appears when the appliance is switched on.

Turning off

Turn the function selector to **0**.

Depending on the operating mode, you may hear an automatic rinse cycle running.

Steam injection

With misting, steam is specifically injected into the oven cavity. This enables you to bake, e.g. bread and bread rolls, with sufficient moisture.

Misting only works with these heating modes:

- Convection + 30% humidity
- Convection + 0% humidity
- Broil + circulated air

To start misting, touch the  symbol. After a short while, steam is injected into the oven cavity.

Steam is injected for approx. 5 minutes.

To cancel misting:

Press the  symbol.

Steam removal

During the steam removal process, cold water is introduced into the oven cavity. This cools the oven cavity down and the steam condenses on the oven cavity walls. When you open the oven door afterwards, only a little steam escapes.

WARNING

Risk of Scalding!

After opening the oven door, hot water may drip down from it.

Steam removal only works with the following heating modes and if the temperature in the oven cavity is less than 265° F (130 °C):

- Convection + 100% Humidity
- Convection + 80% Humidity
- Convection + 60% Humidity
- Broil level 1 + Humidity
- Broil level 2 + Humidity
- Sous-vide cooking

Proceed as follows:

Touch the  symbol. Steam removal lasts about 20 seconds. The heating remains switched off during steam removal.

Stopping steam removal early:

Open the oven door or touch the  symbol.

Notes

- The steam removal function remains available for a short time after turning off the appliance.
- When an automatic program cooking timer runs out, steam removal will be performed automatically at the end of the program.

After every use

1. Remove food residues from the oven cavity as soon as the appliance has cooled down. Burnt-on soil will be much harder to remove later.
2. In order to dry the oven cavity, the cooling fan and the fan wheel on the back wall of the oven cavity continue to run for a while after the appliance is switched off. They then switch off automatically. This may take up to 95 minutes. The appliance door must remain closed while the oven cavity is being dried.
3. If required, you can dry the oven cavity quickly using the drying program. → *"Drying program" on page 43*
4. Once the oven cavity has cooled down, polish it with a soft cloth.
5. Wipe furnishings or handles dry if condensate has collected on them.

Safety shut-off





For your protection, the appliance has a safety shut-off feature. Every heating operation is switched off after 12 hours if the appliance is not operated during this time. A message appears in the display.

Exception:
programming with the long-term timer.

Turn the program selection to **0**, after which you can operate the appliance in the manner to which you are accustomed.

Timer functions

In the timer menu, set:

-  Timer
-  Stopwatch
-  Cooking time (not in the idle state)
-  Cooking time end (not in the idle state)

Launching the timer menu

You can launch the timer menu from any mode. Only from the factory settings, program selection is set to **S**, the time menu is not available.

Touch the  symbol.

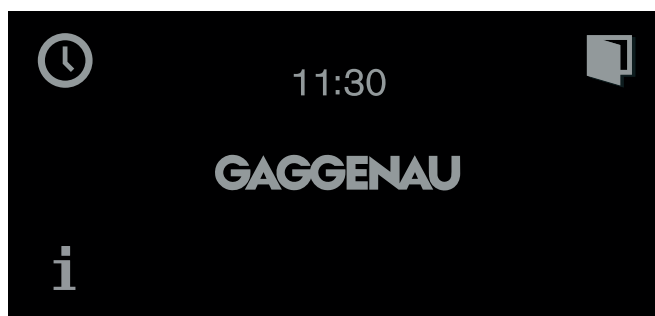

The timer menu appears.

Timer

The timer runs independently of the other appliance functions. You can enter a maximum of 90 minutes.

Setting the timer

1. Call up the Timer menu.
The "Timer" function  is displayed.
2. Turn the rotary selector to set the desired time.

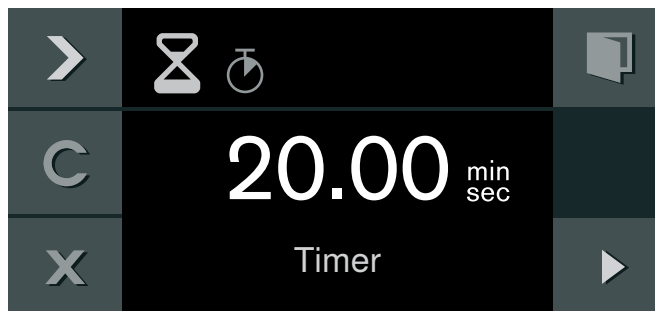

3. Start with ▶.

The Timer menu closes and the timer starts to run. The symbol for the timer ⌚ appears on the display and the time can be seen counting down.

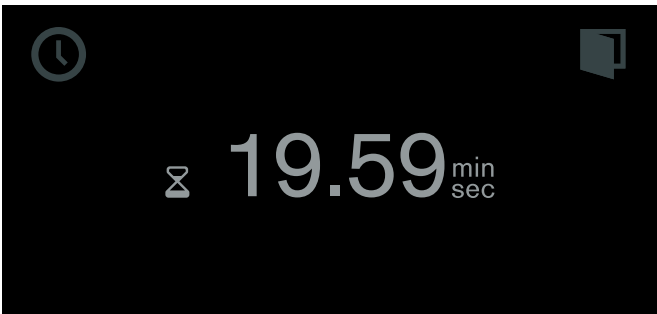

A signal sounds once the time has elapsed. The audible signal ceases if you touch the ✓ symbol.

You can exit the Timer menu at any time by touching the ✕ symbol. This way, the settings are lost.

Suspend timer:

Call up the Timer menu. Select the "Timer" function with ▶, select ⌚, and touch the || symbol. To let the timer run on, touch the ▶ symbol.

Switch off the timer early:

Call up the Timer menu. Select the "Timer" function with ▶, select ⌚, and touch the C symbol.

Stopwatch

The stopwatch runs independently of the other appliance functions.

The stopwatch counts up from 0 seconds to 90 minutes.

It has a pause function. Therefore, you can stop the timer in between times.

Starting the stopwatch

1. Launch the timer menu.
2. With ▶, select the "Stopwatch" function ⌚.

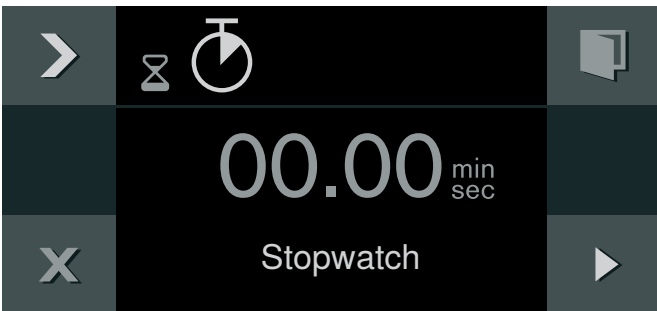

3. Start with ▶.

The timer menu is closed and the time runs. The ⌚ symbol and the elapsing timer are shown in the display.

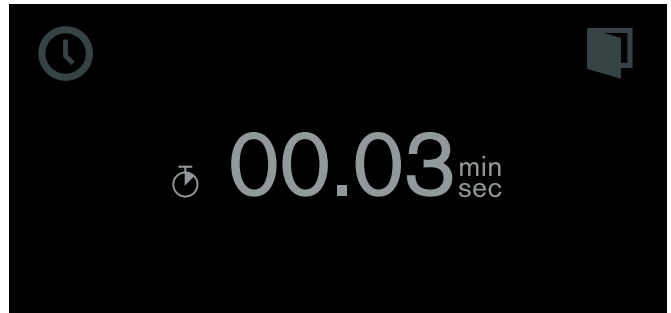

Stopping and restarting the stopwatch

1. Launch the timer menu.
2. With ▶, select the "Stopwatch" function ⌚.
3. Touch the || symbol.

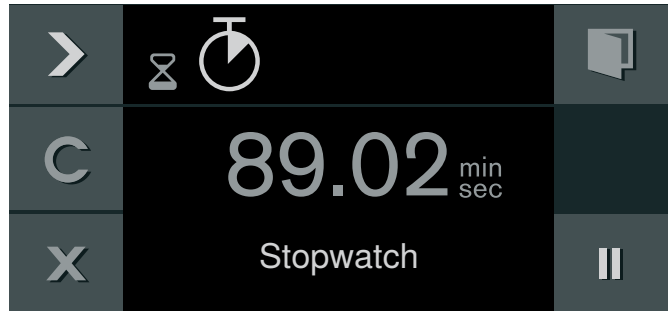

The time stops. The symbol changes to Start ▶ again.

4. Start with ▶.

The time continues to run. Once 90 minutes have been reached, the display pulsates and a signal sounds. It goes off when you touch the ✓ symbol. The ⌚ symbol disappears from the display. The operation has ended.

Switching off the stopwatch:

Launch the timer menu. With ▶, select the "Stopwatch" function ⌚ and touch the C symbol.

Cooking time

If you set a cooking time for your meal, the appliance switches off heating automatically after this time has elapsed.

You can set a cooking time from 1 minute to 23:59 hours.

Setting the cooking time

You have set the heating function and temperature and you have placed your dish in the oven interior.

1. Touch the ⌚ symbol.
2. With ▶, select the "Cooking time" function ⌚.

3. Set the required cooking time with the rotary selector.



4. Start with ▶.

The appliance starts. The timer menu is closed. The temperature, the operating mode, the remaining cooking time and the end of the cooking time appear in the display



One minute before expiration of the cooking time, the expiring cooking time is enlarged in the display.

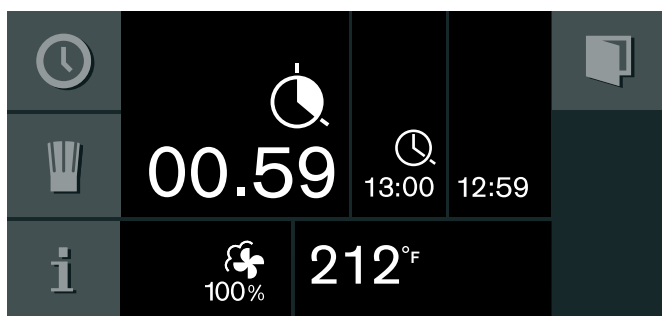

The appliance switches off after expiration of the cooking time. The pulsates and a signal sounds. It goes off prematurely if you touch the symbol, open the appliance door or set the program selection to 0.

Changing the cooking time:

Launch the timer menu. With , select the "Cooking time" function . Set the cooking time with the rotary selector. Start with .

Clearing the cooking time:

Launch the timer menu. With , select the "Cooking time" function . Clear the cooking time with . Return to normal operation with .

Canceling the entire operation:

Set the program selection to 0.

Note: You can also change the heating function and temperature during the cooking time.

End of cooking time

You can defer the end of the cooking time until later.

Example: it is 2 pm. The meal takes 40 minutes to cook. It should be ready by 3.30 pm.

Enter the cooking time and shift the end of the cooking time to 3.30 pm. The electronic circuitry calculates the starting time. The appliance starts automatically at 2:50 pm and switches off at 3.30 pm.

Note that easily perishable foodstuffs must not be left in the oven for too long.

Shifting the end of the cooking time

You have set the heating function, the temperature and the cooking time.

1. Touch the .
2. With , select the "End of cooking time" function .

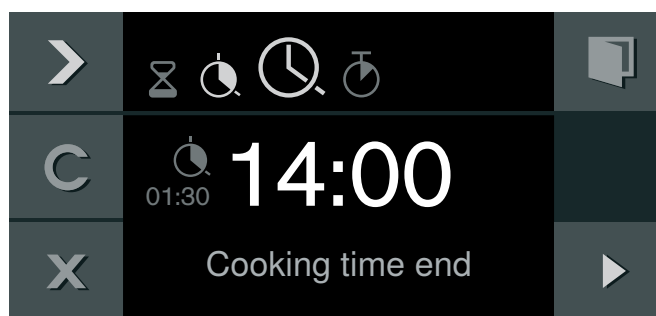

3. Set the required cooking time end with the rotary selector.

4. Start with ▶.



The appliance assumes a waiting mode. The operating mode, the temperature, the cooking time and the end of the cooking time appear in the display. The appliance starts at the calculated time and switches off automatically when the cooking time has elapsed.

Note: If the symbol flashes: you have not set a cooking time. Always set a cooking time first.

The appliance switches off after expiry of the cooking time. The pulsates and a signal sounds. It goes off prematurely if you touch the , open the appliance door or set the program selection to 0.

Changing the cooking time end:

Launch the timer menu. With **>**, select "End of cooking time" **🕒**. Set the required cooking time end with the rotary selector. Start with **▶**.

Canceling the entire operation:

Set the program selection to **0**.

Sabbath mode and Yom Tov mode

Sabbath mode

With this function, the appliance maintains a temperature between 120 and 450°F (50 and 230°C) with Convection + 0% humidity.

You can keep dishes warm for up to 74 hours without having to switch on or off.

Note that easily perishable foodstuffs must not be left in the oven for too long.

Note: You must activate the Sabbath mode in the factory setting in order to operate the mode. → "Basic settings" on page 37

Follow these steps:

1. Set the program selector to **S**.
2. Select "Factory setting" with the rotary selector.
3. Confirm by touching the **✓** symbol.
4. Rotate the selector to Sabbath mode **🕒**.
5. Confirm by touching the **✓** symbol.
6. Rotate the selector to "activate".
7. Confirm by touching the **✓** symbol.
8. Turn the oven off.

Setting the Sabbath mode

1. Set the program selector to **🕒**.
2. Touch the **🕒** symbol.

The suggested value of 24h at 185° F (85° C) appears in the display. Start with **▶**

- or -

Change the cooking time and the temperature.

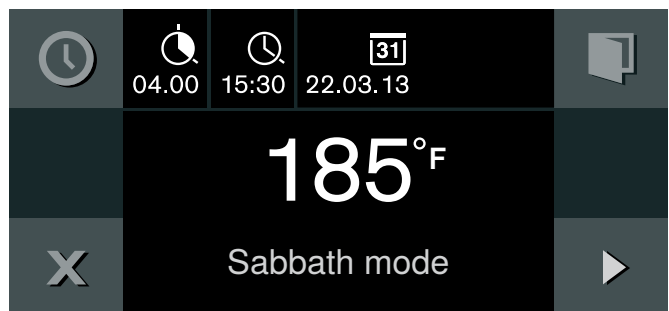

3. Changing the cooking time **🕒**:
Touch the **🕒** symbol. Set the preferred cooking time with the rotary selector. You can set up to 74 hours. Confirm by touching the **✓** symbol. Then changing the temperature becomes an option.
4. Changing the temperature:
Set the required temperature with the rotary selector.

5. Start with ▶.

The appliance starts.  and the temperature appear in the display. The Sabbath screen will appear as shown.



The oven and display lighting is off. The control panel is blocked and no tone can be heard when you touch it.

The appliance no longer heats after expiry of the time. The display is blank. Set the program selector to **0**.

Switching off:

To cancel the operation, set the program selector to **0**.

Yom Tov mode

With this function, the appliance is programmed to perform in three stages.

Stage 1 and 2 can be programmed for a maximum total duration of 74 hours. The duration of Step 3 is 1 hour and cannot be modified.



Stage 1: maintains a warm temperature of 122° F (50° C) in the convection heating function. The interior oven lights remain off through this stage.

Stage 2: the appliance raises to a desired temperature setting and maintains a temperature between 120 and 450° F (50 -230° C). For warming and cooking foods in the convection heating function. The desired time can be adjusted for this stage. The interior oven lights will be on during this time.

Stage 3: maintains a warm temperature of 122° F (50° C) in the convection heating function for 1 hour after stage 2 has ended. The interior oven lights will be on during this time.

Note that easily perishable foodstuffs must not be left in the oven for too long.





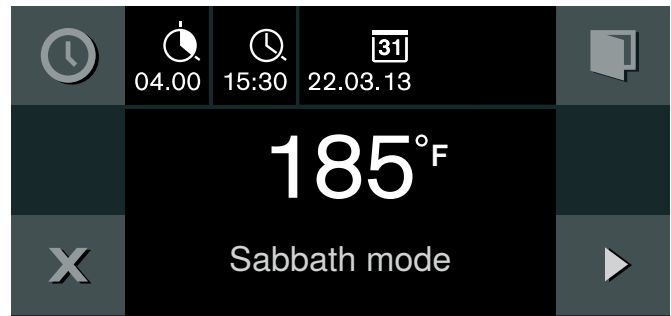

Setting the Yom Tov mode

1. Set the program selector to .
2. Touch the .

The suggested value of 24h at 185° F (85° C) appears in the display.



To set Stage 2 cooking time with rotary selector:

1. Touch the  symbol to adjust the duration of Stage 2 cooking time .
2. Set the desired Stage 2 cooking time with the rotary selector.
3. Touch the  symbol to adjust the end of Stage 2 cooking time .
4. Select the end time with the rotary selector.
5. Change the date if needed by touching the  symbol to .
6. Rotate the selector to the desired date.
7. Confirm settings by touching the  symbol.

To set Stage 2 temperature:

1. Rotate selector to desired Stage 2 temperature.
2. Start with ▶.

The temperatures of Stage 1 and Stage 2 appear in the display. The remaining time to the beginning of Stage 2 is counted down in the display. The Yom Tov screen will appear as shown.

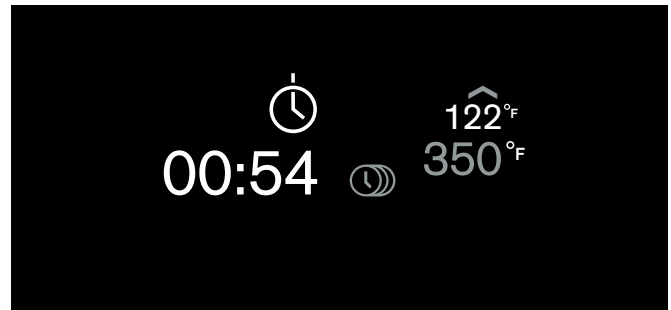

The program will begin with the pre-set warm temperature without light, then advance to the programmed temperature with light until the end of the set date and time, and then maintain the pre-set warm temperature for 60 minutes.

The appliance no longer heats after expiry of the time. The display is blank. Set the program selector to **0**.

Switching off:

To cancel the operation, set the program selector to **0**.

Panel Lock

The appliance has a panel lock to make sure children cannot operate it inadvertently.

Notes

- You must set the child lock in the factory setting to "Available" → "Basic settings" on page 37
- If there is a power cut while the child lock is activated, it may be deactivated when the power returns.

Activating the child lock

Requirement:

Program selector is set to 0.

Touch the  symbol for at least 6 seconds.

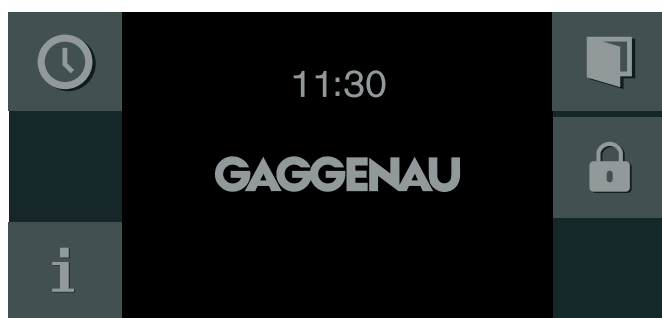

The child lock is activated. The standby screen appears. The  appears at the top of the display.

Deactivating the child lock

Requirement:

Program selector is set to 0.

Touch the  symbol for at least 6 seconds.

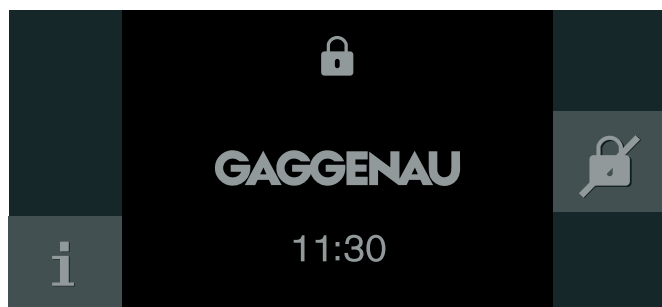

The child lock is deactivated. You can switch on the appliance in the usual manner.

Automatic programs

You can prepare a wide range of food using the automatic programs. The appliance will choose the optimal setting for you.

To achieve good results, the cooking compartment must not be too hot for the type of food you have selected. If it is, a message will appear on the display. Allow the appliance to cool and then try again.

Information on the settings

- The cooking result depends on the quality of the food and the size and type of cookware. For an optimal cooking result, only use food that is in good condition and meat that is chilled to refrigerator temperature. For frozen food, use food straight out of the freezer only.
- The automatic program suggests a temperature, type of heating and cooking time.
- For some dishes, you will be required to enter the weight. It is not possible to set weights outside of the intended weight range.
- For some dishes, you will be asked to enter desired level of browning, the thickness of the food and/or the cooking level of the meat or vegetables.
- For some dishes, the cooking compartment is preheated empty. Place the food in the cooking compartment once the preheating is complete and a message appears in the display.
- Your preferred settings will be shown next time as a suggestion.

Core temperature probe

For some recipes, you will need the core temperature probe. Use the core temperature probe for these recipes. → "Core temperature probe" on page 30

Selecting a dish

The following categories are available. One or more dishes are listed beside each category.

Note: The last selected category is displayed in the first position.

Categories:





- Meat and poultry
- Fish
- Vegetables
- Side and oven dishes

- Dessert
- Bread and pastries
- Raising dough
- Regenerating
- Defrosting

Applying settings for dishes

You are guided through the entire setting process. Follow the instructions in the display.

Use the rotary selector to scroll through the individual levels.

1. Set the function selector to .
2. Touch the  symbol. Press  to confirm.
3. Use the rotary selector to select the category and press  to confirm.
4. Use the rotary selector to select the required dish and press  to confirm.

The possible settings appear in the display. For many dishes, you can change the settings to suit your needs.

For some dishes, you must set the weight.

Tip: By pressing the  symbol, you can receive information about accessories and preparation methods.

5. Press  to confirm the required settings. Follow the directions in the display.



Once the cooking time has elapsed, the appliance stops heating up and steam removal takes place. An audible signal sounds.

Opening the appliance door affects the cooking result. Open the appliance door only briefly. The automatic program is interrupted and continues to run after closing the appliance door.

Adding extra cooking time

After the cooking time has ended, you can leave some dishes to continue cooking if you are not satisfied with the cooking result.

A query appears in the display asking if you want to continue cooking.

1. Press  to confirm.
2. Select a single or double cooking time, depending on requirements.
3. Press  to start.
4. If the "Continue cooking" function has ended, turn the function selector to **0**.

Note: If you touch the  symbol during continued cooking, the steam removal and the continue cooking function is ended.





Changing and canceling

After starting the appliance, the settings can no longer be changed.

If you want to cancel the operation, turn the function selector to **0**.

Calling up the last automatic programs used

The last five dishes with the selected settings are saved. You have the option of saving these dishes with the selected settings as individual recipes. You can no longer change the settings of an individual recipe if you have saved it using the "Last automatic programs" function

1. Set the function selector to .  is displayed.
2. Touch the  symbol.
3. Use the rotary selector to select "Last automatic programs" and press  to confirm.
4. Use the rotary selector to select the required dish and press  to confirm.
5. Enter a name for the dish and save. → *"Entering a name" on page 29*

Personal recipes



You can save up to 50 individual recipes. You can record a recipe. You can assign these recipes a name so that you can fall back on them quickly and conveniently if you need them.

Recording a recipe

You can set up to five phases in succession and you can record them.

1. Set the program selection to the required heating function.

The  symbol is displayed.

2. Touch the  symbol.
3. Choose a free storage location with the rotary selector.
4. Touch the  symbol.

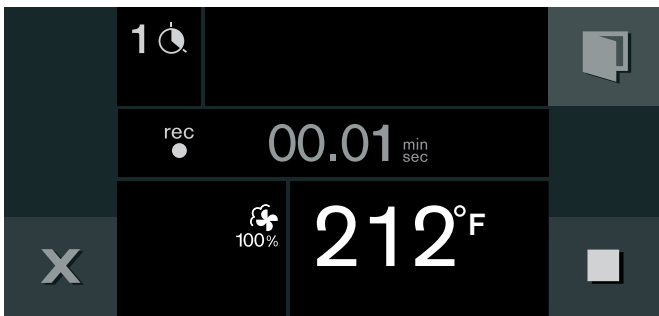



5. Set the desired temperature with the rotary selector.
6. The cooking time is recorded.
7. Recording another phase:
Set the program selection to the required heating function. Set the required temperature with the rotary selector. A new phase begins.
8. Once the appliance has achieved the desired cooking result, touch the  symbol to end the recipe.
9. Enter the name under "ABC". → "Entering a name" on page 29

Notes

- Recording a phase does not begin until the appliance has reached the set temperature.
- Every phase must last at least one minute.
- During the first minute you can change the heating function or the temperature.

Enter the core temperature for a phase:



Insert the core temperature probe in the socket in the oven interior. Set the heating function and temperature. Touch the  symbol. With the rotary selector, enter the required temperature and confirm it with .

Programming a recipe

You have the option of programming and saving up to five phases of preparation.





1. Set the program selection to the required heating function. Set the required temperature with the rotary selector.

The  symbol is displayed.

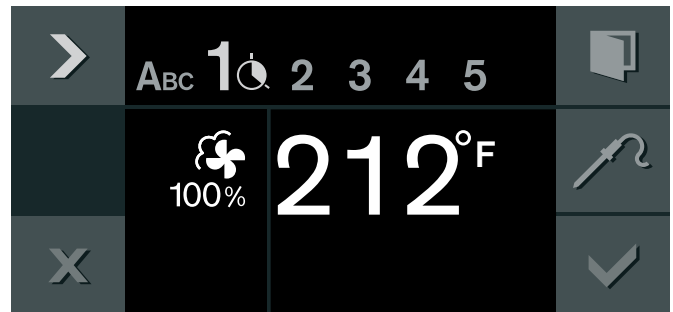

2. Touch the  symbol.
3. Choose a free storage location with the rotary selector.
4. Touch the  symbol. → "Entering a name" on page 29
5. Enter the name under "ABC".
6. Choose the first phase with the  symbol.

The heating function and temperature set at the start are displayed. You can change the heating function and temperature with the rotary selectors.



7. Choose the time setting with the  symbol.
8. Set the required cooking time with the rotary selector.
9. Choose the next phase with the  symbol.
- or -
Preparation is complete, end input.
10. Save with .
- or -
Cancel with  and quit the menu.

Enter the core temperature for a phase:

Choose the next phase with the  symbol. Set the heating function and temperature. Touch the  symbol. With the rotary selector, enter the required temperature and confirm it with .

Note: For phases for which a core temperature has been programmed you cannot set a cook time.

Entering a name

1. Enter the recipe's name under "ABC".

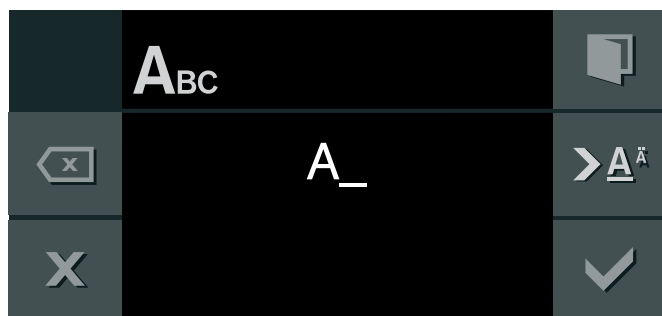

Rotary selector	Selecting letters A new word always begins with an upper case letter.
➤A ^Ä	Press briefly: cursor to the right Press long: switch to diacritics and special characters Press twice: insert line space
➤Ä	Press briefly: cursor to the right Press long: switch to normal characters Press twice: insert line space
⊞	Clear letters

2. Save with ✓.

- or -

Cancel with **X** and quit the menu..

Note: For entering a name, Latin characters, certain special characters and numbers are available.

Starting a recipe

1. Set the function selector to ☼.
2. Touch the 🍷 symbol.
3. Use the rotary selector to select "Individual recipes" and press ✓ to confirm.
4. Use the rotary selector to select the desired recipe.
5. Press ▶ to start.

The operation begins. The cooking time starts counting down.

The settings for each phase are shown in the display.

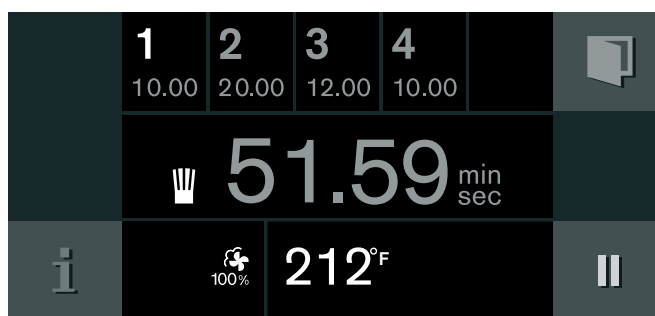

Notes

- The cooking time does not start counting down until the appliance has reached the set temperature.
- You can use the rotary selector to change the temperature while the recipe is in progress. This does not change the saved recipe.
- Insert the core temperature probe, if the recipe contains a saved core temperature.

Change recipe

You can change the settings of a recorded or programmed recipe.

1. Set the function selector to ☼.
2. Touch the 🍷 symbol.
3. Use the rotary selector to select "Individual recipes" and press ✓ to confirm.
4. Use the rotary selector to select the desired recipe.
5. Touch the _ symbol.
6. Use the ➤ symbol to select the desired phase.
The programmed heating type, temperature, and cooking time are displayed. You can change the settings with the rotary selector or the function selector.
7. Save with ✓.
- or -
Cancel with **X** and exit the menu.

Deleting a recipe

1. Set the function selector to ☼.
2. Touch the 🍷 symbol.
3. Use the rotary selector to select "Individual recipes" and press ✓ to confirm.
4. Use the rotary selector to select the desired recipe.
5. Delete the recipe with **C**.
6. Press ✓ to confirm.

Core temperature probe

The core temperature probe makes it possible to cook with exact precision. It measures the temperature inside the food being cooked. When the required core temperature has been reached, the probe switches off automatically, ensuring that all food is cooked perfectly.

The core temperature probe is damaged at temperatures above 480°F (250°C). Therefore, only ever use it in your appliance at a maximum temperature setting of 445°F (230°C).

⚠ WARNING

Risk of electric shock!

Use of a wrong core temperature probe can damage the insulation. Use only the core temperature probe intended for this appliance.

⚠ WARNING

Risk of burns!

The oven interior and the core temperature probe become very hot. Use oven mitts to plug and unplug the core temperature probe.

Only use the core temperature probe supplied. You can purchase it as a spare part from Customer Service or from the online shop.

When using the core temperature probe, never place the food on the top shelf position in the oven.

After use, always remove the core temperature probe from the oven cavity. Never store it inside the oven cavity.

After each use, clean the core temperature probe with a damp cloth. Do not clean in the dishwasher.

Inserting the core temperature probe into the food

Insert the core temperature probe into the food before you place the food in the oven cavity.

The core temperature probe has three measuring points. Insert the core temperature probe as far as possible. The core temperature probe must not be inserted in the fat or be touching the ovenware or bones.

Meat: Insert the core temperature probe at an angle from above as far as it will go into the meat.

For more than one piece of meat, insert the core temperature probe into the middle of the thickest piece.

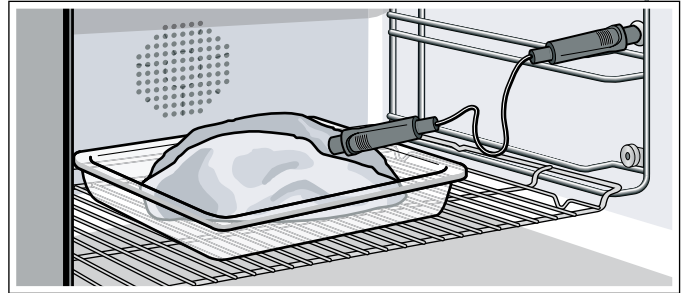

Poultry: Insert the core temperature probe as far as it will go into the thickest point in the breast. Depending on its structure, insert the core temperature probe into the poultry crossways or lengthways. With poultry, make sure that the tip of the core temperature probe does not protrude into the cavity in the middle of the bird.

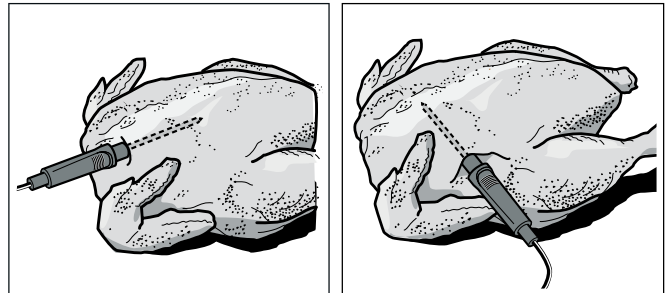

Fish: Insert the core temperature probe behind the head as far as it will go towards the spine. Place the whole fish onto the wire rack and prop it up in the swimming position using half a potato.

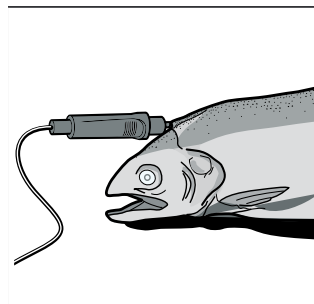

Turning the food: If you want to turn the food, do not remove the core temperature probe. Once you have turned the food, check that the core temperature probe is correctly positioned in the food.

If you remove the core temperature probe during operation of the appliance, all settings are reset and you have to apply them again.

Setting the core temperature

CAUTION



Damage to the core temperature probe:

The core temperature probe may be damaged if the distance between the grill heating element and the core temperature probe is too small. Make sure that the distance between the grill heating element and the core temperature probe or the cable of the core temperature probe is a few centimeters. The meat may expand during the cooking process.

CAUTION

Damage to the core temperature probe:

Do not trap the cable of the core temperature probe in the appliance door.

1. Insert the food to cook in the oven cavity with a core temperature probe inserted. Insert the core temperature probe into the socket in the oven cavity and close the appliance door.
2. Turn the function selector to the desired heating type.
3. Use the rotary selector to set the oven cavity temperature.
4. Touch the  symbol. Use the rotary selector to change the set core temperature for the food and confirm with .
The core temperature set must be higher than the current core temperature.
5. The appliance heats with the set heating type.
The display indicates the current temperature, and below that the set core temperature.

You can change the set core temperature at any time.

Once the set core temperature is reached, a signal sounds. Cooking is automatically ended. Confirm with  and turn the function selector to **0**.

Estimated cooking time

After preheating, if the appliance has a temperature setting above 212° F (100 °C), when the core temperature probe is inserted, the display shows an estimated cooking time approx. 5–20 minutes into the cooking time.

The estimated cooking time is continually updated. The longer the cooking process lasts, the more precise the estimated cooking time becomes. Do not open the appliance door; this distorts the estimated cooking time.

The estimated cooking time is displayed in normal operation and in the automatic program.



The current core temperature is shown in the display when you touch the **i** symbol.

The estimated cooking time display can be deactivated in the basic settings so that the current core temperature is shown instead. → "Basic settings" on page 37

Notes

- At the beginning of the cooking time, "<59° F" ("<15° C") is displayed for 3-4 minutes for the current core temperature.
- The measurable range is 59 to 210° F (15° C to 99° C). Outside the measurable range, <59° F or --° F ("<15° C" or "--° C") is displayed as the current core temperature.
- If you leave the food in the cooking compartment for some time after cooking, the core temperature will continue to rise somewhat due to the residual heat in the cooking compartment.
- If you set programs with the core temperature probe and the cooking timer at the same time, the appliance switches off whichever program reaches the entered value first.

Changing the set core temperature

Touch the  symbol. Use the rotary selector to change the set core temperature for the food and confirm with .

Deleting the set core temperature

Touch the  symbol. Delete the set core temperature with **C**. The appliance continues heating in normal cooking mode.

Core temperature guidelines

Use chilled food only, not frozen food. The details given in the table are guidelines. Results depend on the quality and composition of the food.

For hygiene reasons, critical foodstuffs such as fish and game should reach a core temperature of 143 - 158° F (62 - 70 °C); for poultry and minced meat this should be as high as 176 - 185° F (80 - 85 °C).

Food	Core temperature guideline
Beef	
Sirloin, tenderloin, entrecôte	
very rare	113 - 117°F (45 - 47 °C)
rare	122 - 126°F (50 - 52 °C)
medium	137 - 140°F (58 - 60 °C)
well-done	158 - 167°F (70 - 75 °C)
Roast beef	176 - 185°F (80 - 85 °C)
Pork	
Pork roast	162 - 176°F (72 - 80 °C)
Pork loin	
medium	149 - 158°F (65 - 70 °C)
well-done	167°F (75 °C)
Meat loaf	185°F (85 °C)
Fillet of pork	149 - 158°F (65 - 70 °C)
Veal	
Veal roast, well-done	167 - 176°F (75 - 80 °C)
Breast of veal, stuffed	167 - 176°F (75 - 80 °C)
Saddle of veal	
medium	137 - 140°F (58 - 60 °C)
well-done	149 - 158°F (65 - 70 °C)
Fillet of veal	
rare	122 - 126°F (50 - 52 °C)
medium	137 - 140°F (58 - 60 °C)
well-done	158 - 167°F (70 - 75 °C)

Food	Core temperature guideline
Game	
Saddle of venison	140 - 157°F (60 - 70 °C)
Leg of venison	158 - 167°F (70 - 75 °C)
Venison loin steaks	149 - 158°F (65 - 70 °C)
Saddle of hare or rabbit	149 - 158°F (65 - 70 °C)
Poultry	
Chicken	195°F (90 °C)
Guinea fowl	175 - 185°F (80 - 85 °C)
Goose, turkey, duck	185 - 195°F (85 - 90 °C)
Duck breast	
medium	131 - 140°F (55 - 60 °C)
well-done	158 - 176°F (70 - 80 °C)
Ostrich steak	140 - 149°F (60 - 65 °C)
Lamb	
Leg of lamb	
medium	140 - 149°F (60 - 65 °C)
well-done	158 - 176°F (70 - 80 °C)
Saddle of lamb	
medium	131 - 140°F (55 - 60 °C)
well-done	149 - 167°F (65 - 75 °C)
Mutton	
Leg of mutton	
medium	158 - 167°F (70 - 75 °C)
well-done	176 - 185°F (80 - 85 °C)
Saddle of mutton	
medium	158 - 167°F (70 - 75 °C)
well-done	176 °F (80 °C)
Fish	
Fillet	144 - 149°F (62 - 65 °C)
Whole	149°F (65 °C)
Terrine	144 - 149°F (62 - 65 °C)

Food	Core temperature guideline
Other provisions	
Bread	205°F (96 °C)
Paté	162 - 167°F (72 - 75 °C)
Terrine	140 - 158°F (60 - 70 °C)
Foie gras	113°F (45 °C)
Reheating food	167°F (75°C)

Home Connect

This appliance can be networked and also controlled remotely using a mobile device. The Home Connect app offers extra functions that complement the networked appliance perfectly. If the appliance is not connected to your home network, it can be operated as usual via the display.

The availability of the Home Connect function depends on the availability of Home Connect services in your country. Home Connect services are not available in every country. You can find more information on this at www.home-connect.com.

Notes

- Ensure that you follow the safety instructions in this instruction manual and that you comply with these even when you are away from home and are operating the appliance via the Home Connect app. You must also follow the instructions in the Home Connect app.
- Operating the appliance directly from the appliance always takes priority. It is not possible to operate the appliance using the Home Connect app during this time.
- Refer to the Home Connect documents supplied for more information.

Setting Up

To configure settings via Home Connect, you will need to have installed the Home Connect app on a mobile device.

Your appliance will also need to be connected to your home network and to the Home Connect app. You can choose between the following connection types:

- Connection via LAN cable: The appliance is connected to the home network automatically following confirmation on the appliance.
- Connection via Wi-Fi: Establish the connection to your home network and then the connection to the Home Connect app.

Note: The app will guide you through the entire registration process. In case of doubt, follow the instructions in the app.

Installing the app

Install the Home Connect app on your mobile device (e.g. tablet PC or smartphone).

1. On your mobile device, go to the App Store (Apple devices) or the Google Play Store (Android devices).
2. Enter the search term "Home Connect".

3. Select the Home Connect app and install it on your mobile device.
4. Launch the app and set up Home Connect access.

The app will guide you through the registration process.

Connecting the appliance to your home network (LAN)



The appliance must be connected to your home network using a LAN cable.

The network connection will be established automatically when the appliance is connected to the mains electricity supply for the first time and put into operation.



Connecting the appliance to your home network (Wi-Fi with WPS)

Requirements:

- Your router must have a WPS button. You will find information about this in the manual for your router.
- You need to be able to access your router.



1. In the basic settings, select  "Home Connect".
2. Touch the  symbol.
3. Turn the rotary selector to "Wi-Fi".
4. Confirm by touching the  symbol.

A message about the WPS function will appear.



5. Touch the  symbol to continue.
6. Turn the rotary selector to "Automatic (WPS)".
7. Touch the  symbol to start the connection process.
8. Press the WPS button on the router within the next 2 minutes.

If the display shows "Network connection successful", the connection process is complete. Follow the instructions in the app.

Connecting the appliance to your home network (Wi-Fi without WPS)

1. In the basic settings, select  "Home Connect".
2. Touch the  symbol.
3. Turn the rotary selector to "Wi-Fi".
4. Confirm by touching the  symbol.

A message about the WPS function will appear.

5. Touch the  symbol to continue.
6. Turn the rotary selector to "Manual".
7. Touch the  symbol to start the connection process.

The appliance will set up its own "Home Connect" Wi-Fi network to which the tablet or smartphone must be connected.



8. Follow the instructions in the app.

If the display shows "Network connection successful", the connection process is complete. Follow the instructions in the app.

Connecting the appliance to the app

Connect your appliance to the app when setting up Home Connect or connect your appliance to an additional Home Connect account. The Home Connect app can be installed on any number of mobile devices, which can then be connected to the appliance.

Requirements:

- The appliance is connected to your home network.
 - The Home Connect app has been installed on the mobile device.
1. To connect an additional account, select "Home Connect" in the basic settings.
 2. Use the rotary selector to select "Connect to app".
 3. Touch the  symbol and start the connection process with .
 4. Follow the instructions in the app.

If the display shows "Connection to app successful", the connection process is complete.



Remote Start

Remote start must be activated in order to start and operate your appliance via the Home Connect app. If remote start is deactivated, only the appliance operating modes can be displayed in the Home Connect app and appliance settings can be implemented.

The remote start is automatically deactivated if the appliance door is opened.

When you start the oven using a type of heating on the appliance itself, remote start is activated automatically. You can now make changes or start a new program from your mobile device.

Activating remote start

1. Set the function selector to .
2. Touch the  symbol.
 appears next to the **i** symbol.







Remote start is now activated. You can now use the mobile end device to start a type of heating via the app and transfer the required settings to the appliance.

To deactivate the remote start: Touch the  symbol.

Home Connect settings

Home Connect can be adapted to your specific needs at any time.

Note: You will find the Home Connect settings in the basic settings for your appliance. Which settings the display shows will depend on whether Home Connect has been set up and whether the appliance is connected to your home network.

	Basic setting	Possible settings	Explanation
	Connection type	LAN/Wi-Fi	You can switch between connection types (LAN cable and Wi-Fi). Follow the instructions for setting up the relevant connection type. → <i>"Setting Up" on page 33</i>
	Connecting	Connect/disconnect	Switch the network connection on or off as required (e.g. for holiday). Network information is retained after the appliance is switched off. After switching on the appliance, you will need to wait for a few seconds while it reconnects to the network. In networked standby mode, the appliance requires max. 2 W.
	Connect to app		Start the connection process between the app and the appliance.
	Software update		As soon as a new software version is available, a message appears in the display. You can install the new software in the Home Connect menu ↓.
	Remote control	Activate/deactivate	Access the appliance's functions via the Home Connect app. When deactivated, only the appliance's operating statuses will be displayed in the app.
	Delete network settings		All network settings can be deleted from the appliance at any time.
	Appliance information		The display shows: <ul style="list-style-type: none"> • MAC address COM module • Serial number of the appliance • Software version <p>You can view more information – such as the SSID (network name), although this depends on the connection type – by touching the arrow button.</p>

Remote Diagnostics

Customer Service can use Remote Diagnostics to access your appliance if you contact them, have your appliance connected to the Home Connect server and if Remote Diagnostics is available in the country in which you are using the appliance

Note: For further information and details about the availability of Remote Diagnostics in your country, please visit the Service/Support section of your local website: www.home-connect.com

Information on Data Protection

When your appliance is connected to a WLAN network that is connected to the Internet for the first time, your appliance transmits the following categories of data to the Home Connect server (initial registration):

- Unique appliance identification (consisting of appliance codes as well as the MAC address of the installed Wi-Fi communication module).
- Security certificate of the Wi-Fi communication module (to ensure a secure data connection).
- The current software and hardware version of your appliance.
- Status of any previous resetting to factory settings.

This initial registration prepares the Home Connect functions for use and is only required when you want to use these Home Connect functions for the first time.

Note: Ensure that the Home Connect functions can be used only in conjunction with the Home Connect app. Information on data protection can be accessed in the Home Connect app.

Declaration of Conformity

Gaggenau Hausgeräte GmbH hereby declares that the appliance with Home Connect functionality meets the basic requirements and other relevant provisions of Directive 2014/53/EU.

A detailed RED Declaration of Conformity can be found online at www.gaggenau.com among the additional documents on the product page for your appliance.



2.4 GHz band: max. 100 mW
5 GHz band: max. 100 mW

	BE	BG	CZ	DK	DE	EE	IE	EL
	ES	FR	HR	IT	CY	LV	LT	LU
	HU	MT	NL	AT	PL	PT	RO	SI
	SK	FI	SE	UK	NO	CH	TR	

5 GHz WLAN (Wi-Fi): For indoor use only

Wi-Fi® Module

FCC/IC Statements

Model: COM2
FCC ID: 2AHES-COM2
IC: 21152-COM2

The Home Connect module is a communication device designed to provide communication between appliances and smart devices.

This module is integrated at the factory, under direct control of BSH Home Appliances Corporation, and is not user servicable or upgradable. At least 7⁷/₈ inch (20 cm) separation distance should be maintained from device to user.

FCC COMPLIANCE STATEMENT



CAUTION

Changes or modifications not expressly approved could void your authority to use this equipment.

This device complies with Part 15 of the FCC Rules. Operation to the following two conditions:

1. This device may not cause harmful interference, and
2. This device must accept any interference received, including interference that may cause undesired operation.

INDUSTRY CANADA STATEMENT

This device complies with Industry Canada license-exempt RSS standard(s).

Operation is subject to the following two conditions:













1. This device may not cause interference, and
2. This device must accept any interference, including interference that may cause undesired operation of the device.











Operation in the band 5150-5250 MHz is only for indoor use to reduce the potential for harmful interference to co-channel mobile satellite systems.











Basic settings

In the general settings, you can adapt your appliance individually.

1. Set the program selector to **S**.
 2. Select "General setting" with the rotary selector.
 3. Touch the ✓ symbol.
 4. Set the required general setting with the rotary selector.
 5. Touch the ↵ symbol.
 6. Set the general setting with the rotary selector.
 7. Save with ✓ or cancel with ✕ and quit the current general setting.
 8. Turn the program selector to **0** to quit the general setting menu.
- Changes are saved.

	Basic setting	Possible settings	Explanation
	Brightness	Stages 1, 2, 3, 4, 5*, 6, 7, 8	Setting display brightness
	Standby screen	On*/Off - Clock - Clock + GAGGENAU logo* - Date - Date + GAGGENAU logo - Clock + date - Clock + date + GAGGENAU logo	Appearance of the standby screen. Off: no display. Use this setting to reduce the standby consumption of your appliance. On: several displays can be set, confirm "On" with ✓ and choose the desired display with the rotary selector. The selection is displayed.
	Display screen	Minimized*/Standard	When 'Minimized' is set, only the most important details are displayed after a short time.
	Touchpad color	Gray*/White	Select the color of symbols on the touchpads
	Touchpad tone	Tone 1*/Tone 2/Off	Select the signal tone when touching a touchpad
	Touchpad volume	Levels 1, 2, 3, 4, 5*, 6, 7, 8	Sets the volume of the touchpad tone
	Preheating signal	On*/Off	The signal tone sounds when the required temperature is reached during preheating.
	Signal volume	Levels 1, 2, 3, 4, 5*, 6, 7, 8	Sets the volume of the signal tone
	Water filter	Available* / not available	Available: use appliance with water filter. Not available: use appliance without water filter.
	Water filter capacity	100 - 9000 liters	Set the water filter capacity
	Water hardness	1-18	Check mains water with the included carbon hardness test. Set the measured water hardness.
	Time format	AM/PM / 24 h*	Time display in 24 or 12-hour format

	Time	Current time	Setting the time
	Daylight savings	Manual*/Automatic	Automatic time changeover when changing daylight savings time. If automatic: setting of the month, day and week when the time is to be changed. To be set separately for summer and winter time.
	Date format	D.M.Y* D/M/Y M/D/Y	Setting the date format
	Date	Current date	Setting the date. Switch between the year/month/day with the > symbol.
	Temperature unit	°C* / °F	Setting the temperature unit
	Weight unit	kg*/oz.	Set the weight unit
	Language	German* / French [...] / English US / English	Selecting the language for the text display Note: The system will restart if the language is changed. This process takes a few seconds. The basic settings menu is then closed.
	Factory settings	Restore appliance to factory settings	Confirm the question "Delete all individual settings and restore appliance to factory settings?" with ✓ or cancel with ✕. Note: When restoring factory settings, the personal recipes are also deleted. After restoring the factory settings, you will see the "Initial settings" menu.
	Demo mode	On/Off*	For presentation purposes only. The appliance does not heat in the demo mode, but all other functions are available. The "Off" setting must be activated for normal operation. The setting is only possible in the first three minutes after connecting the appliance.
	Cleaning program demo	Start cleaning program demo	For presentation purposes only. No cleaning and heating function. The demo cleaning program takes 10 minutes. It can be ended at any time. You need a new or previously-used standard cleaning cartridge. The appliance must be connected to the water and waste water lines. Dry the cooking compartment manually afterwards.
	Sabbath mode	Not available*/Available	Available: Sabbath mode can be set.

	Display estimated cooking time with core temperature probe	On*/off	On: Estimated cooking time is shown in the display when the core temperature probe is used.
	Door lock	Off*/On	The door lock prevents unintentional opening of the appliance door. When "On" is set, you must touch the  symbol for several seconds before the door opens.
	Childproof lock	Not available*/Available	Available: The childproof lock can be activated. → <i>"Basic settings" on page 37</i>
	Home network	<div style="display: flex; align-items: center;"> <div style="margin-right: 5px;">LAN/ WLAN</div> <div> <p>Connection type</p> <p> Connection</p> <p> Connect to app</p> <p> Software update</p> <p> Remote control</p> <p> Delete network settings</p> <p> Appliance information</p> </div> </div>	Settings for the connection to the home network and the mobile devices. Different setting options will be displayed depending on the connection status.
* Factory settings			

Cleaning and maintenance

If taken care of and cleaned conscientiously, your appliance will stay beautiful and intact for a long time. Here we explain how to take care of and clean your appliance correctly.

WARNING

Risk of electrical shock!

Moisture entering the appliance can cause an electrical shock. Don't use a high-pressure cleaner or steam cleaner.

WARNING

Risk of burns!

The appliance becomes very hot. Never touch the hot inside surfaces of the oven interior or heating elements. Always allow the appliance to cool down. Keep children away.

WARNING

Risk of injury!

Scratched glass in the appliance door can burst. Do not use any glass scrapers or strong or abrasive cleaning agents.

Cleaning agents

Pay attention to the information in the table to ensure that the various surfaces are not damaged by incorrect cleaning agents.

Do not use any

- sharp or abrasive cleaning agents
- metal or glass scrapers to clean the glass on the appliance door.
- metal or glass scrapers to clean the door seal.
- hard abrasive pads or cleaning sponges.

Thoroughly rinse out new sponge cloths before use.

Area	Cleaning agents
Door panels	Glass cleaner: Clean with a window cloth or a microfibre cloth. Do not use a glass scraper.
Display	Wipe down using a microfibre cloth or a slightly damp cloth. Do not wipe with a wet cloth.
Stainless steel	Hot soapy water: Clean using a dish cloth and then dry with a soft cloth. Remove splashes and patches of limescale, grease, starch and albumin (e.g. egg white) immediately. Corrosion can form under these patches or splashes. Special stainless-steel cleaning products are available from Customer Service or from specialist retailers.
Aluminum	Clean with a mild window cleaning agent. Using a window cloth or a lint-free microfibre cloth, wipe over the surfaces lightly in a horizontal direction.
Oven cavity	Hot soapy water: Clean with a dish cloth and dry with a soft cloth. Do not use oven spray or other aggressive oven cleaners or abrasive materials. Scouring pads, rough sponges and pan cleaners are also unsuitable. These items scratch the surface. Always dry the oven cavity after cleaning. → <i>"Drying program"</i> on page 43
NOTICE	
If traces of cleaning product are left on the surface, patches and marks can appear when the oven cavity is heated up. Wash off all traces of cleaning and care product thoroughly with clean water before drying the oven cavity.	
Very dirty oven cavity	The cleaning program removes stubborn dirt. → <i>"Cleaning program"</i> on page 41
Glass ceramic grilling surface	Clean the glass ceramic grilling surface in the oven cavity regularly with glass ceramic cleaner (order number 00311499 from Customer Service or from our online shop).
Glass cover for the oven cavity light	Hot soapy water: Clean with a dish cloth.

Area	Cleaning agents
Door seal Do not remove.	Hot soapy water: Clean with a dish cloth and do not scour. Do not use metal or glass scrapers for cleaning.
Water tank	Clean in the dishwasher as necessary. Remove the lid and place the water tank upside down in the dishwasher.
Core temperature probe	Wipe with a damp cloth. Do not clean in the dishwasher.
Cooking container, wire rack	Dishwasher or hot soapy water. Soak burnt-on remnants and remove with a brush. Remove light-colored patches on stainless steel (egg white/albumen residues) with lemon juice.

Microfiber cloth

The honeycomb microfiber cloth is particularly suitable for cleaning sensitive surfaces such as glass, glass ceramic, stainless steel or aluminum (product no. 00460770, also available from our online shop). It removes liquid and greasy deposits in one go.

Drain filter

You can clean the drain filter in the oven cavity floor as necessary. When cooking fish or meat, we recommend cleaning the appliance after each use.

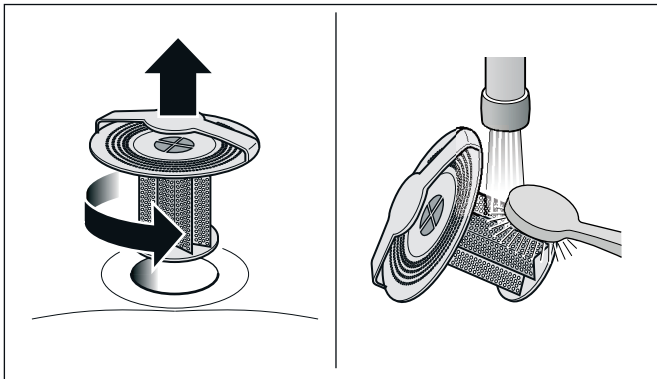

1. Turn the drain filter anticlockwise and remove it.
2. Remove any food remnants from the drain filter.
3. Rinse it out under running water. If it is very dirty, wash it in the dishwasher.
4. Insert the drain filter and turn it clockwise as far as it will go.

Never operate the combi-steam oven without the drain filter in place.

Cleaning program

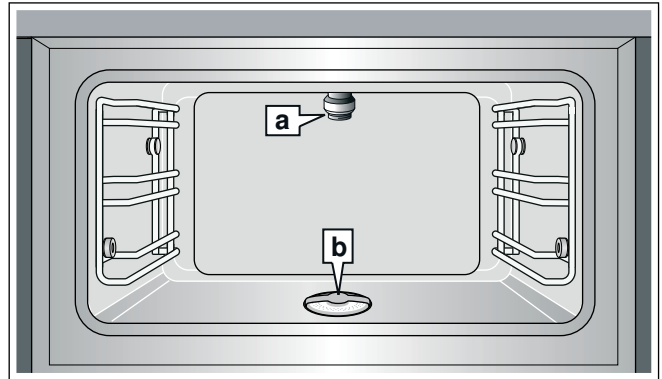

The cleaning program removes stubborn dirt. A cleaning cartridge (a) is screwed into the top of the oven cavity. The oven cavity is cleaned, rinsed, and dried completely automatically. The drain filter (b) must remain inserted in the oven cavity floor while the cleaning program is in progress.

The complete cleaning program takes either 3 hours and 20 minutes or 3 hours and 45 minutes depending on the appliance model you have.

With normal use, we recommend cleaning the appliance with the cleaning program four times a year. Depending on the use, more frequent cleaning can be necessary.

If there are a lot of food remnants in the oven cavity, do not allow them to burn on. Start the cleaning program as soon as the appliance has cooled to 104° F (40 °C).

You need special cleaning cartridges for the cleaning program. These are available from Customer Service or from the online shop (CL S10 040 set with 4 cleaning cartridges, order number 00311703).

The cleaning cartridges can only be used once and are not refillable. Do not use any other cleaner.

NOTICE



Damage to the oven cavity

Use cleaning cartridges only for the cleaning program. Never place cleaning cartridges in the hot oven cavity or heat them in the oven cavity.

Note:

- The cleaning program can only be started if the appliance is cooled off below 104°F (40°C).
- Remove all accessories from the oven cavity before you start the cleaning program (wire rack, cooking containers, core temperature probe).
- Remove the worst soiling from the oven cavity.
- The drain filter must remain inserted in the oven cavity floor while the cleaning program is in progress. If the drain filter is removed before the cleaning program is started, the oven cavity will not be clean at the end of the program.
- The appliance door is locked during the cleaning program.
- Do not try and open the appliance door during the cleaning program. Water could escape.
- Always leave the cleaning program run to the end. The cleaning program cannot be canceled.

Starting the cleaning program

1. Set the function selector to **S**.
2. The  symbol is displayed. Press  to confirm.
3. The switch-off time is displayed at which the cleaning program will end. If desired, move switch-off time with the rotary selector. Press  to confirm. The starting time and switch-off time are shifted, the cleaning time remains the same.

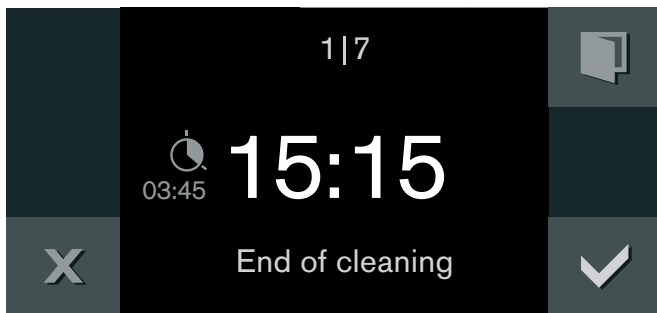



4. Remove all accessories from the oven cavity and remove the coarse dirt. Press  to confirm.
5. Remove the cover cap from the cleaning cartridge.

CAUTION

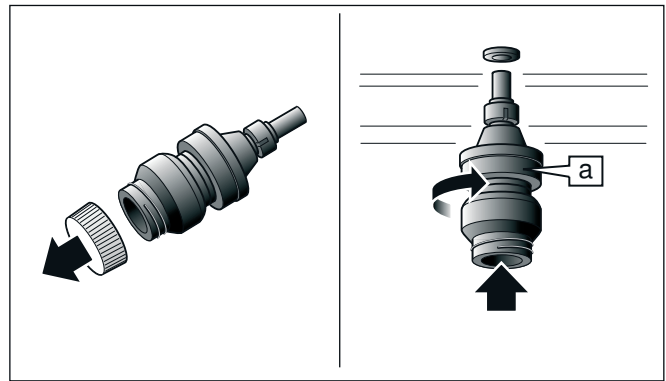
Do not remove the wax plugs from the opening of the cleaning cartridge. Do not use any other detergents. Do not use damaged cartridges.



6. Screw the cleaning cartridge (**a**) as far as it will go into the socket in the top of the oven cavity. Close the appliance door. Press  to confirm. A cleaning time of 3:45 hours is displayed.
7. Start with . The cleaning time counts down on the display. The light in the oven cavity remains switched off. The appliance door is locked.

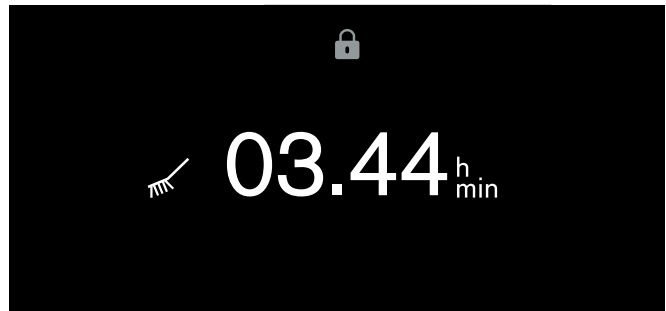

After the cleaning program has finished, a signal sounds. The appliance door is unlocked. A message appears on the display.

8. Remove the cleaning cartridge.

NOTICE

Damage to the oven cavity: never heat the appliance up if a cartridges has been inserted.

9. Turn the drain filter on the oven cavity floor to the left and remove it. Remove food residues from the drain sieve. Rinse out under running water.

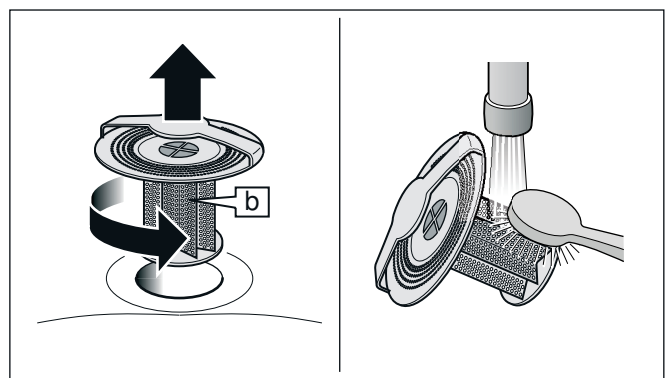

10. Insert the drain filter and turn right to the stop. Press ✓ to confirm.

The cleaning program is complete. Allow the appliance to cool down. Then polish the oven cavity and the glass with a soft cloth.

Note: The final rinse cycle may leave white streaks in the oven cavity and on the glass after drying. This depends on the water hardness. Remove the white streaks with a damp cloth

Dispose of the empty cleaning cartridge in accordance with regional regulations for household waste.

Causes for unsatisfactory cleaning results

If the oven cavity is still not clean once the cleaning program has ended, use the chart below to help you identify the causes. Then insert a new cleaning cartridge and start the cleaning program again.

Possible cause	Solution
Locking cap on the cleaning cartridge	<p>The locking cap has not been removed from the cleaning cartridge.</p> <p>Once the cleaning program has ended, remove the cartridge from the appliance. Do not reuse the cartridge. Dispose of the cartridge in accordance with the local regulations.</p>
<p>⚠ WARNING</p> <p>Risk of injury! To prevent the detergent from coming into contact with your skin or eyes, do not remove the locking cap from a spent cartridge.</p>	
Drain filter not inserted	The drain filter must remain inserted in the oven cavity floor while the cleaning program is in progress.
Power failure	Following a power cut that lasts longer than 3 minutes, the cleaning program is ended with a short program.
Stubborn burnt-on food residues	Run the cleaning program again to remove stubborn food residues.

Drying program

With the drying program, you can dry the oven cavity quickly.

The drying program takes 20 minutes.

Starting the drying program

1. Set the function selector to **S**. Select the drying program with the rotary selector.
2. The  symbol is displayed. Confirm with ✓.
3. The drying time of 20 minutes appears. Touch ▶ to start. The drying time elapses on the display. The lamp in the oven cavity remains off.

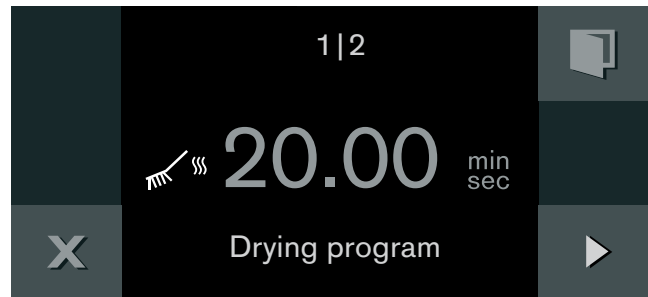

4. A signal sounds after 20 minutes. A message appears in the display. Confirm with ✓.

The drying program has ended. Allow the appliance to cool down. Then polish the oven cavity and the panel with a soft cloth.

Descaling program

Regular descaling keeps the appliance in good condition. The descaling program descales and rinses the appliance fully automatically.

Depending on the type of water and your use of the appliance, a message in the display reminds you to run the descaling program.

To prevent damage to the appliance, the operating modes that use steam are disabled after this message has been repeated. You can still use the appliance to run operating modes that do not require steam. Only once the descaling program has been run can the appliance be used again without restrictions.

The descaling program takes 1 hour 45 minutes from beginning to end.

For the descaling program, you require special descaling tablets. These are available from Customer Service or from our online shop (17002490, set with four descaling tablets).





NOTICE

- **Risk of damage to the appliance:** Limescale may damage the appliance. Descale the appliance regularly.
- **Risk of damage to the appliance:** Using the wrong descaler may damage the appliance. Only use the specified descaling tablets.
- **Risk of damage to the oven cavity:** Use the descaling tablet for the descaling program only. Place the descaling tablet into the tank. Never place the descaling tablet in the oven cavity or heat it up in the oven cavity.

Note:

- Remove all accessories from the oven cavity before starting the descaling program (wire rack, cooking containers, core temperature probe).
- The drain filter must remain inserted in the oven cavity floor while the descaling program is in progress.
- Always allow the descaling program to run to the end. The descaling program cannot be cancelled.
- Depending on the water type and your use of the appliance, descaling may still be required even if you use the water descaling system (optional accessory GF 111 100). A message appears in the display to remind you of this.

Starting the descaling program

1. Set the function selector to **S**. Use the rotary selector to select the descaling program.
2. The  is displayed. Press  to confirm.
3. The switch-off time at which the descaling program will end is displayed. If required, you can alter the switch-off time using the rotary selector. Press  to confirm.
4. Remove all accessories from the oven cavity. Press  to confirm.
5. Remove the descaling tablet from the plastic packaging.

WARNING

Risk of injury!

Descaling tablets may cause chemical burns in the mouth, throat, eyes and on the skin. Follow the safety instructions on the packaging of the descaling tablets. Avoid the skin coming into contact with the descaling tablets. Keep children away from descaling tablets.

WARNING

Risk of injury!

The descaling solution may cause chemical burns in the mouth, throat and eyes or on the skin. Avoid the skin coming into contact with the descaling solution. Keep children away from descaling solution. Do not drink the descaling solution. The descaling solution must not come into contact with food. Rinse out the water tank thoroughly before you next use the appliance.

CAUTION

Risk of damage to the appliance

Using the wrong descaler may damage the appliance. Only use the specified descaling tablets.

6. Remove the tank from the appliance and take off the lid.
7. Place the descaling tablet in the compartment at the back of the tank. Fill the tank with water up to the "Max." mark (3.5 pints / 1.7 liters).

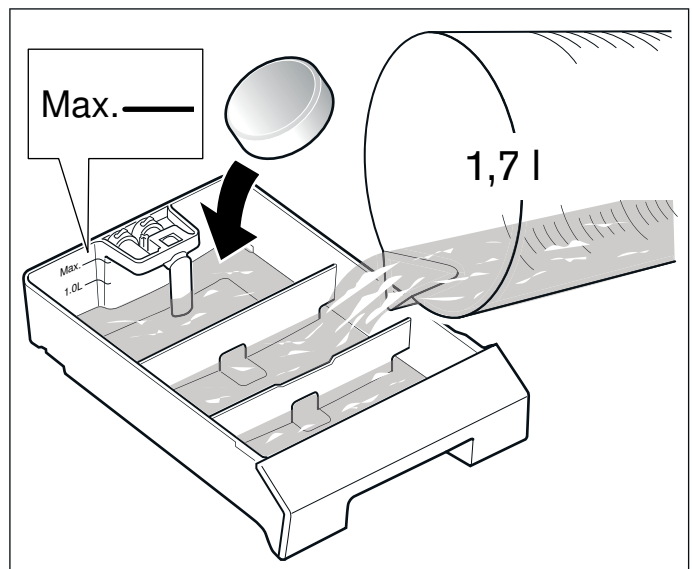

8. Position the lid on the tank and click it into place.
9. Slide the tank into the appliance.
10. Close the appliance door. Press  to confirm. A descaling time of 1 hour 45 minutes is displayed.

11. Press ► to start. The descaling time will count down on the display. The light in the oven cavity remains switched off.

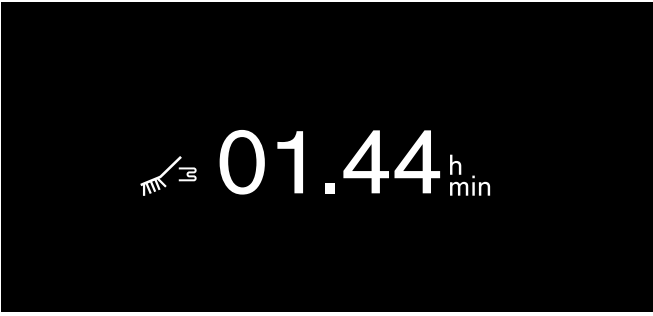

Note: After approx. 1:30 hours, a message appears in the display. Remove and empty the tank. Clean the tank thoroughly. Fill the water tank with fresh water. Slide the tank into the appliance. Confirm by pressing ✓. Press ► to start the rinsing process.

Drying the oven cavity

Dry the oven cavity after descaling using the drying program. Remove the water tank and dry it with a soft cloth.

Removing the wire racks

The wire racks can be removed for cleaning.

Detaching the wire racks

1. Place a dishcloth in the oven cavity to protect the enamel from scratches.
2. Undo the knurled nuts (Fig. A).
3. Lift the wire racks slightly sideways away from the screw and pull them out towards the front (Fig. B).

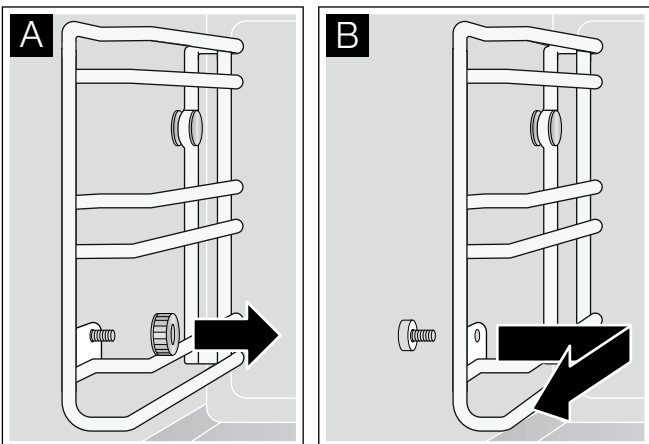

You can clean the wire racks in the dishwasher.

Refitting the wire racks

1. Attach the wire racks the right way round – with the end stop at the back.
2. Slide the back of wire racks onto the bolts, then reattach them at the front.
3. Tighten the knurled nuts.

Note: If a knurled nut is lost, you can order it from Customer Service as a spare part. The use of non-original knurled nuts may lead to corrosion in the oven cavity.

Troubleshooting

You can often easily eliminate problems that may occur on your own. Before calling Customer Service, take into account the following information.

WARNING

Risk of electric shock!

Improper repairs are dangerous. Only an authorized service provider may perform repairs and may replace damaged plug and connections. Remove the power plug or turn off the circuit breaker or fuse in the fuse box if the appliance is damaged or not working. Call Customer Service.





WARNING

Risk of injury!

The light emitted by LED lights is very dazzling, and can damage the eyes (risk group 1). Do not look directly into the switched on LED lights for longer than 100 seconds.

LED lights

Defective LED lights must only be replaced by the manufacturer, their customer service department or a licensed technician (electrician).

Disruption	Possible cause	Solution
Appliance not working, no display	Plug not inserted	Connect the appliance to the electricity mains
	Power failure	Check whether other kitchen appliances are working
	Fuse defective	Check in the fuse box whether the fuse for the appliance is in working order
	Operating error	Switch off the fuse for the appliance in the fuse box and switch it on again after about 10 seconds
The appliance does not work, the display shows "Device locked. Descaling required."	Build-up of limescale in the appliance	Start the descaling program → "Descaling program" on page 43
Despite descaling, "Please descale" appears on the display	Build-up of limescale in the appliance, wrong descaler used	Use the specified descaling tablets, start the descaling program → "Descaling program" on page 43
Appliance cannot be started	Appliance door is not quite closed	Close appliance door
The appliance is not working and the display does not respond.  appears on the display	Childproof lock activated	Deactivating the childproof lock
Appliance switches off automatically	Safety deactivation: the appliance has not been operated for longer than 12 hours	Confirm the message with  , switch off the appliance and set it again.
Appliance does not heat up,  appears in the display	Appliance is in the demo mode	Deactivate demo mode in the basic settings
Appliance will not start, a message appears in the display	No water in the appliance	Check water intake
The core temperature probe is inserted; 99 °C is displayed	Moisture on the core temperature probe shaft or on the socket in the cooking compartment	Move the core temperature probe shaft in and out of the socket in the cooking compartment several times
The core temperature probe is inserted but the  symbol is not displayed	Moisture on the socket in the oven cavity	Move the core temperature probe shaft in and out of the socket in the oven cavity several times
No steam visible	Steam is not visible above 212° F (100° C)	This is normal

The  "steam removal" symbol does not appear	You can use the steam removal function only up to a temperature of 266°F (130 °C)	This is normal
Powerful steam outlet at the top of the door	The operating mode has been changed	This is normal
Extreme amounts of steam emerging at the side of the door	Door seal soiled or loose	Clean the door seal and insert it in the groove
Humming when turned on	Water outlet pump is warming up	Normal operating sound
	Appliance was not used for a few days	Normal: automatic rinsing at start up
A wistling noise can be heard during heating up	Noises may be produced during steam generation	This is normal
There is a 'plop' noise during cooking	Stress expansion in the event of a large temperature difference	This is normal
Steaming is not possible	Build-up of limescale in the appliance. Appliance must be descaled to avoid damage to the appliance	Starting the descaling program → <i>"Descaling program" on page 43</i>
Appliance does not steam properly any more	Appliance is clogged with scale	Start the descaling program
The lighting does not work	The lighting is defective	Call Customer Service
Error message "Exxx"		If an error message appears, turn the program selection to 0 ; if the display goes off, it was a one-time problem. If the problem occurs repeatedly or if the display stops, please contact after-sales service and inform them of the error code.
Water drips out when you open the appliance door	The collecting channel on the underside of the door panel is full	Dry the collecting channel with a sponge

Power cut

Your appliance can bridge a power cut of a few seconds. Operation continues.

If the power cut was for a longer period and the appliance was in operation, a message appears in the display. Operation is interrupted.

Set the function selector to **0**, then the appliance can be operated again as usual.

Demo mode

The demo mode is activated if the  symbol appears in the display. The appliance does not heat up.

Briefly disconnect the appliance from the mains (switch off the domestic fuse or the circuit-breaker in the fuse box). Then deactivate the demo mode within 3 minutes in the factory setting. → *"Basic settings" on page 37*

Customer service

If your appliance needs repairs, our customer service is there for you. We work hard to help solve problems quickly and without unnecessary service calls, getting your appliance back up and running correctly in the least amount of time possible.

When you call, please indicate the product number (E-Nr.) and serial number (FD-Nr.) so that we can support you in a qualified manner. You will find the type plate with these numbers on the bottom of the appliance. To avoid having to search for a long time when you need it, you can enter your appliance data and the customer support telephone number here.

E-Nr.	FD-Nr.
Customer Service 	

Please read the use and care instructions provided with your appliance. Failure to do so may result in an error in using the appliance. This could result in a service call that instead of fixing a mechanical issue is only needed for customer education. Such calls are not covered by the appliance warranty.

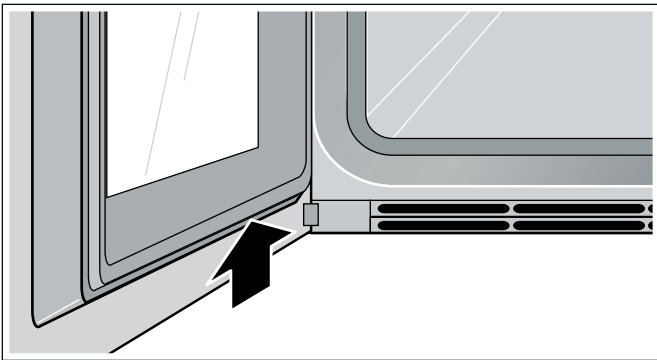

Please find the contact data of all countries in the enclosed customer service list.

To book a service visit and product advice

USA 877 442 4436
toll-free

CANADA 877 442 4436
toll-free

Tables and tips

Notes

- The cooking times specified are intended as a guide. The actual cooking times depend on the quality and temperature of the food before cooking and the weight and thickness of the food to be cooked.
- The specifications refer to average quantities for four people. If you would like to prepare more, you should calculate a longer cooking time.
- Use the cookware specified. If you use other cookware, cooking times may be longer or shorter.
- If you have not made a particular dish before, use the shortest time specified to start with. You can extend the cooking time if necessary.
- Open the oven cavity door of the preheated oven for a short time only and do not take too long to place your food inside the appliance.
- When steaming, defrosting, dough proving and reheating, you can use up to three rack levels at a time (rack levels 1, 2 and 3 from the bottom). This will not cause flavor to transfer. This allows fish, vegetables and desserts to be prepared at the same time. However, the specified cooking times may need to be extended for large quantities of food.
- If you are only baking on one level, use level 2. If you are baking on two levels at the same time, use levels 1 and 3.
- Do not allow the food to come into contact with the oven cavity or the back panel of the oven.
- The combination steam oven must shut properly. Keep the seal surfaces clean at all times.
- Do not place too many items close together on wire racks or containers. This is to ensure an optimal steam circulation.
- When cooking very cold foods and when cooking at high temperatures, the cooking container may deform. This deformation does not impair its performance. When the cooking container cools down again, it returns to its original shape.
- If you wish to prepare food using steam and the appliance has been heated to over 100 °C (for example because it has just been used for baking), allow the appliance to cool down before steaming your food. Otherwise, the high temperature will cause your food to dry out.

Vegetables

- Vegetables are prepared better in steam than in boiling water: The taste, color, and consistency are retained better. Virtually none of the water-soluble vitamins and nutrients are washed out. Since the combi-steam oven works without pressure at just 212° F (100 °C), the preparation is much gentler than in a pressure cooker, for example.
- All details refer to 2 lb (1 kg) washed vegetables.
- For steaming vegetables, use the perforated cooking container; insert it at the second level from the bottom. Slide the unperforated cooking container underneath it. Use the vegetable broth as the basis for a sauce or a vegetable stock.
- Blanching takes 8–10 minutes in the pre-heated appliance. If the vegetables or fruit will not be served immediately, chill in ice water to prevent continued cooking due to residual heat.
- When steaming at temperatures up to 212° F (100 °C), no preheating is necessary. Place the food in the cold oven cavity and then switch on the appliance.

Food	Cooking container	Temperature in °F (°C)	Humidity in %	Cooking time in min.	Comments
Artichokes, large	perforated	212 (100)	100	60–65	
Artichokes, small	perforated	212 (100)	100	45–50	
Cauliflower, whole	perforated	212 (100)	100	25–30	
Cauliflower, in florets	perforated	212 (100)	100	15–25	
Beans, green	perforated	212 (100)	100	35–50	
Broccoli, in florets (in accordance with EN 60350-1)	perforated	195-212 (90-100)	100	20–25	Recipe tip: Serve with almonds roasted in butter.
Chicory	perforated	212 (100)	100	25–30	
Peas, fresh	unperforated	212 (100)	100	25–30	cover with water
Fennel, in slices	perforated	212 (100)	100	20–25	
Vegetable terrine	perforated/wire rack	195 (90)	100	50–60	in a terrine mold
Peas, frozen (in accordance with EN 60350-1), 6.6 lb (3 kg)	perforated	212 (100)	100	35–45	
Carrots, in slices 0.2 in (0.5 cm)	perforated	212 (100)	100	20–25	
Potatoes, peeled and quartered	perforated	212 (100)	100	30–35	
Kohlrabi, in slices	perforated	212 (100)	100	25–35	
Leeks, in slices	perforated	212 (100)	100	20–30	
Leeks, whole	perforated	212 (100)	100	35–45	
Bell pepper, stuffed	unperforated	355-390 (180–200)	80 / 100	20–25	Preheat. With meat filling, brown the filling in advance.
Unpeeled boiled potatoes, approx. 1.7 oz (50 g) apiece	perforated	212 (100)	100	30–35	
Unpeeled boiled potatoes, approx. 3.5 oz (100 g) apiece	perforated	212 (100)	100	35–40	
Brussels sprouts	perforated	212 (100)	100	25–30	

Food	Cooking container	Temperature in °F (°C)	Humidity in %	Cooking time in min.	Comments
Beets, sliced	perforated	212 (100)	100	65–75	
Asparagus, green	perforated	212 (100)	100	15–20	
Asparagus, white	perforated	212 (100)	100	20–35	
Spinach	perforated	212 (100)	100	8–12	Then sweat in a pot with onions and garlic.
Sweet potatoes, sliced	perforated	212 (100)	100	15–20	
Peeled tomatoes	perforated	212 (100)	100	3–4	Preheat. Cut the tomatoes, and rinse with ice-cold water after steaming.
Zucchini, sliced	perforated	212 (100)	100	15–20	
Snap peas	perforated	212 (100)	100	10–15	

Fish

- Steaming is a cooking method that does not use any fat and does not allow fish to dry out.
- For food hygiene reasons, fish should have a core temperature of at least 144 - 149° F (62–65 °C) after cooking. This is also the ideal cooking temperature.
- When steaming at temperatures of 195 - 212° F (90–100 °C), no preheating is necessary. Place the dish in the oven when it is cold and then switch on the appliance.
- Do not season the fish with salt until it is fully cooked. This will ensure that the natural flavor is retained and that less water is drawn out of the fish.
- When using the perforated cooking container, you can grease the container if the fish sticks too much.
- Place the unperforated cooking container on the first level from the bottom to avoid getting fish stock on the oven cavity surfaces.
- For fillets with skin, place the fish on the cooking container or wire rack with the skin side up – this helps to retain its texture and flavor.

Food	Cooking container	Temperature in °F (°C)	Humidity in %	Cooking time in min.	Comments
Gilthead bream, whole 1.1 lb (500 g) apiece	perforated	212 (100)	100	20–30	Can be cooked in swimming position if you set it on half a potato.
Fish dumplings, 0.7 - 1.4 oz (20–40 g) apiece	unperforated	195-212 (90-100)	100	8–12	Line the unperforated cooking container with greaseproof paper.
Shrimp	unperforated	175 (80)	100	10–12	
Lobster, cooked, removed from the shell, reheating	perforated	160-175 (70–80)	100	10–15	
Carp, blue, whole, 3.3 lb (1.5 kg)	perforated	195-212 (90-100)	100	35–45	in broth
Cod, 8.8 oz (250 g)	unperforated	355 (180)	60	8–12	
Salmon filet, 5.3 lb (150 g)	perforated	175 (80)	100	20–25	
Salmon, whole, 5.5 lb (2.5 kg)	perforated	212 (100)	100	65–75	
Blue mussels, 3.3 lb (1.5 kg)	perforated	212 (100)	100	12–15	The blue mussels are cooked as soon as their shells open up.
Atlantic salmon, whole 1.7 lb (800 g)	perforated	195-212 (90-100)	100	20–25	

Food	Cooking container	Temperature in °F (°C)	Humidity in %	Cooking time in min.	Comments
Monkfish filet, 0.6 lb (300 g) apiece	Glass pan/wire rack	355-390 (180-200)	100	8-10	Preheat
Sea bass, whole, 0.8 lb (400 g) apiece	perforated	195-212 (90-100)	100	20-25	



Fish – low-temperature steaming

- If you steam the fish at between 160 and 195° F (70 and 90 °C), it is less likely to be overcooked or to fall apart. This is a particular advantage for delicate fish.
- The values given for the different types of fish refer to fillets.
- Place the unperforated cooking insert on the first level from the bottom to avoid getting fish stock on the oven cavity surfaces.
- Serve on a pre-warmed dish.
- With low temperature steaming, no preheating is necessary. Place the dish into a cold oven and then switch on the appliance.

Food	Cooking container	Temperature in °F (°C)	Humidity in %	Cooking time in min.	Observations
Oysters (10)	unperforated	180 - 190 (80 - 90)	100	7 - 10	In broth
Tilapia (150 g / 5 oz)	perforated	180 - 190 (80 - 90)	100	15 - 17	
Gilthead bream (200 g / 7 oz)	perforated	180 - 190 (80 - 90)	100	17 - 20	
Fish fillet (200 - 300 g / 7 - 11 oz)	perforated	180 - 190 (80 - 90)	100	17 - 20	
Fish terrine	Wire rack	180 - 190 (80 - 90)	100	50 - 90	In a terrine mold
Trout, whole (250 g / 9 oz)	perforated	180 - 190 (80 - 90)	100	17 - 20	
Halibut (300 g / 11 oz)	perforated	180 - 190 (80 - 90)	100	17 - 20	
Scallops (15 - 30 g/ ½ - 1 oz)	unperforated	180 - 190 (80 - 90)	100	9 - 13	The more the scallops weigh, the longer the chosen cooking time should be.
Cod (250 g / 9 oz)	perforated	180 - 190 (80 - 90)	100	15 - 17	
Red snapper (200 g / 7 oz)	perforated	180 - 190 (80 - 90)	100	17 - 20	
Redfish (120 g / 4 oz)	perforated	180 - 190 (80 - 90)	100	15 - 17	
Monkfish (200 g / 7 oz)	perforated	180 - 190 (80 - 90)	100	15 - 17	
Sole rolls, stuffed (150 g / 5 oz apiece)	perforated	180 - 190 (80 - 90)	100	17 - 20	
Turbot (300 g / 11 oz)	perforated	180 - 190 (80 - 90)	100	17 - 20	
Sea bass (150 g / 5 oz)	perforated	180 - 190 (80 - 90)	100	15 - 17	
Pike-perch (250 g / 9 oz)	perforated	180 - 190 (80 - 90)	100	17 - 20	

Meat – cooking at higher temperatures





- The combination of steam and convection is the optimal cooking process for many types of meat. The oven cavity is hermetically sealed in this mode, the moisture prevents the meat from drying out as in conventional convection. Thanks to the variable humidity control, the optimal climate can be achieved for every type of food.
- The cooking times specified should be regarded as guidelines and depend strongly on the initial temperature of the food and the length of time roasted. For better results, use the core temperature probe. For notes and optimal target temperatures, see chapter → *"Core temperature probe"* on page 30.
- Take the meat out of the refrigerator 1 hour before preparation.
- If you are using the perforated cooking inserts or the wire rack, insert an unperforated cooking container underneath. Put a little water in the unperforated cooking insert to prevent burning. In addition, you can add vegetables, wine, spices and herbs in order to create a tasty sauce base.
- If you would like to cook the meat so it is medium or rare: open the door 40° F (5 °C) before the desired core temperature is reached and wait until the target temperature has been reached. This way you prevent overcooking and you give the meat the necessary time to rest.
- Meat's time to rest: Let the meat rest on a wire rack for 5 min. after cooking. This way, the meat can "relax." The circulation of the meat juice slows down and there is less loss of juice when cutting into the meat.

Food	Cooking container	Temperature in °F (°C)	Humidity in %	Cooking time in min.	Comments
Entrecôte, seared, medium rare, 12.3 oz (350 g) apiece	unperforated	340-355 (170–180)	30	10–20	
Filet, seared, medium rare in puff pastry, 1.3 lb (600 g)	unperforated	355-390 (180–200)	80	30–45	Line the cooking container with grease-proof paper.
Rack of veal, seared, medium rare, 2.2 lb (1 kg)	unperforated	320-355 (160–180)	30/60	20–30	If you add liquid to the unperforated cooking container, 30% humidity is sufficient.
Smoked pork, cooked, in slices	unperforated	212 (100)	100	15–20	
Roast pork with crackling (pork roast with rind), well done, 3.3 lb (1.5 kg)	Wire rack + unperforated	1) 320 (160) 2) 445 (230)	80 	60 10	Make crosswise cuts into the crackling before cooking. Use the core temperature probe: In the first stage of cooking, cook the food to a core temperature of up to approximately 150-160°F (65–70 °C), and in the second stage of cooking, cook it up to a core temperature of 160-165°F (70–75 °C).
Rack of lamb, seared, medium rare, 5.3 oz (150 g) apiece	unperforated	320-340 (160–170)	0/30	12–15	
Leg of lamb, seared, medium rare, 5.3 oz (150 g)	unperforated	1) 390 (200) 2) 285 (140)	 30	30 60–70	
Saddle of venison, seared, medium rare, 1.1 lb (500 g) apiece	unperforated	320-340 (160–170)	0/30	12–18	
Roast beef, well done, 3.3 lb (1.5 kg)	Wire rack + unperforated	1) 445 (230) 2) 320 (160)	100 60*	15 60–90	* If you add liquid to the unperforated cooking container, 30% humidity is sufficient.

Food	Cooking container	Temperature in °F (°C)	Humidity in %	Cooking time in min.	Comments
Sirloin, seared, medium rare, 2.2 lb (1 kg)	unperforated	340-355 (170-180)	30	50-60	
Pork roast (neck or shoulder), well done, 2.2 - 3.3 lb (1-1.5 kg)	Wire rack + unperforated	1) 390-430 (200-220) 2) 320-355 (160-180)	100 60*	15 40-60	* If you add liquid to the unperforated cooking container, 30% humidity is sufficient.
Sausage, boiled, heating	unperforated	185-195 (85-90)	100	10-20	e.g. Lyon sausage, white sausage

Meat/poultry – low-temperature cooking

- With low temperature cooking, the dishes are cooked at temperatures of between 140 and 175° F (60 and 80 °C) and for a cooking time of a few minutes up to a several hours until cooked through. This cooking method is mainly used for meat and fish dishes. This preserves the sensory properties (e.g. tenderness and succulence) of the food. By heating it up gently the meat gets evenly pink and extremely juicy but for a very thin crusty edge. Neither turning nor basting are required.
- The cooking times specified should be regarded as guidelines and depend heavily on the initial temperature of the food and the length of time roasted. For better results, use the core temperature probe. For notes and optimal target temperatures, see chapter → *"Core temperature probe"* on page 30.
- Take the meat out of the refrigerator 1 hour before preparation.
- For hygienic reasons, brown the meat on all sides in the pan briefly and over high heat before cooking. This way, the meat has a crust that prevents the juices from escaping and provides a typical roast flavor.
- Season carefully: the slow resting of the meat intensifies all flavors.
- With game and horse meat, the flavor is stronger with low-temperature cooking than with a classic preparation.
- Use the "Low-temperature cooking" mode . Any steam escaping from the food therefore remains in the oven cavity and prevents the food from drying out.
- With this type of heating preheating is not necessary. Please note that you cannot reach any core temperatures above the oven cavity temperature. The rule of thumb is: the set oven cavity temperature should be 50 - 60°F (10-15 °C) above the desired core temperature.
- Toward the end of the cooking time, you can reduce the temperature to 140°F (60 °C). This way, you can extend the cooking time (e.g. if your guests arrive late). If you want to stop the cooking process, the oven cavity temperature may not be higher than the desired core temperature. Thus, large pieces can remain in the oven cavity for 1 - 1.5 hours, small pieces for 30-45 minutes.
- Serve on a pre-warmed dish.

Food	Cooking container	Temperature in °F (°C)	Type of heating	Cooking time in min.	Comments
Duck breast, medium rare, 0.7 lb (350 g)	unperforated	160-175 (70-80)		40-60	Skin side can be browned crisp in the pan after cooking. Or: Grill + air recirculation 445°F (230 °C) for 5 minutes.
Entrecôte, medium rare, 0.7 lb (350 g)	unperforated	160-175 (70-80)		40-70	
Filet of veal, well done, 2.2 lb (1 kg)	unperforated	175-195 (80-90)		150-200	
Leg of lamb, boned, trussed, medium rare, 3.3 lb (1.5 kg)	unperforated	160-175 (70-80)		180-240	Before cooking, turn in oil with garlic and herbs
Filet of beef, medium rare, 2.2 lb (1 kg)	unperforated	160-175 (70-80)		120-180	

Food	Cooking container	Temperature in °F (°C)	Type of heating	Cooking time in min.	Comments
Beef steaks, medium rare, 6.1 oz (175 g) apiece	unperforated	160-175 (70-80)	☼	30-60	
Sirloin, medium rare, 2.2-3.3 lb (1-1.5 kg)	unperforated	160-175 (70-80)	☼	150-210	
Filet of pork, well done 2.5 oz (70 g) apiece	unperforated	195 (90)	☼	90-115	
Pork medallions, well done, 2.5 oz (70 g) apiece	unperforated	175 (80)	☼	50-70	

Poultry

- The humidity for combination operation prevents drying out, which is essential with poultry. At the same time, thanks to the high temperature, the surface gets crispy and brown. The hot steam has twice as much ability to transfer heat as conventional convection and reaches all parts of the food. Therefore, a chicken is browned evenly and gets crispy, yet the breast meat remains tender and juicy.
- The cooking times specified should be regarded as guidelines and depend heavily on the initial temperature of the food and the food cooked. For better results, use the core temperature sensor. Do not place it in the middle (hollow space), but rather into the chicken breast. For notes and optimal target temperatures, see chapter → "*Core temperature probe*" on page 30.
- If you season poultry primarily with spices and with little or no oil, the skin gets crispier.

Food	Cooking container	Temperature in °F (°C)	Humidity in %	Cooking time in min.	Comments
Duck, whole, 6.6 lb (3 kg)	unperforated	1) 300-320 (150-160) 2) 430 (220)	60 0	80-90 20-30	Cook breast side down. After half the cooking time, turn the duck. This way, the delicate breast meat will not dry out so much.
Duck breast, seared, medium rare, 0.7 lb (350 g) apiece	unperforated	320 (160)	0	25-30	
Chicken, whole, 3.3 lb (1.5 kg)	Wire rack + unperforated	1) 300 (150) 2) 445 (230)	100 ☼	55-65 15	Cook with trussed legs and breast side up.
Chicken breast, filled, steamed, 0.4 lb (200 g) apiece	perforated	212 (100)	100	25-30	Do not preheat. Recipe tip: Fill with spinach and sheep's cheese.
Turkey breast filet, steamed, 0.6 lb (300 g) apiece	perforated	212 (100)	100	17-25	Do not preheat.
Spring chicken, quail, steamed, 0.3-0.4 lb (150-200 g) apiece	perforated	212 (100)	100	20-25	Do not preheat.
Spring chicken, quail, 0.3-0.4 lb (150-200 g) apiece	unperforated	355-390 (180-200)	60/80	15-20	Recipe tip: Brush with oil and herbes de Provence.

Food	Cooking container	Temperature in °F (°C)	Humidity in %	Cooking time in min.	Comments
Pigeon, steamed, 0.6 lb (300 g) apiece	perforated	212 (100)	100	25–35	Do not preheat.
Pigeon, 0.6 lb (300 g) apiece	unperforated	355-390 (180–200)	60/80	25–30	

Sous-vide cooking

Sous-vide cooking is a method of cooking under a vacuum at low temperatures between 120 - 200°F (50 - 95 °C) and in 100% steam.

With this type of heating preheating is not necessary. Sous-vide cooking is a gentle, low-fat method of preparing meat, fish, vegetables and desserts. A vacuum-packing machine is used to heat-seal the food in a special air-tight, heat-resistant cooking bag.

The protective envelope retains the nutrients and flavors. The low temperatures and the direct transfer of heat allow precisely controlled cooking in order to achieve the desired cooking results. It is almost impossible to overcook the food.

Portions

Use the portion sizes listed in the cooking table. For relatively large quantities and items, the cooking time must be adjusted accordingly.

The portions given for fish, meat and poultry correspond to a single serving. A portion size sufficient for four people has been selected for vegetables and desserts.

Rack levels

You can cook on up to two levels. Place the cooking containers on levels 1 and 3 to achieve the best cooking results. When cooking on just one level, use level 2.

Hygiene

WARNING

Health risk!

Sous-vide cooking is a method of cooking at low temperatures. As a result, it is important that you always follow the application and hygiene instructions below:

- Use only fresh, good-quality food.
- Wash and disinfect your hands. Use disposable gloves or cooking/grill tongs.
- Take extra care when preparing critical food, such as poultry, eggs and fish.
- Always thoroughly rinse and/or peel fruit and vegetables.

- Always keep work surfaces and chopping boards clean. Use different chopping boards for different types of food.
- Maintain the cold chain. Make sure that you only interrupt it briefly to prepare the food, and then return the food in its vacuum-sealed bag to the refrigerator for storage before you cook it.
- Food is suitable for immediate consumption only. Once the food is cooked, consume it immediately. Do not store it after cooking – not even in the refrigerator. It is not suitable for reheating.

Vacuum-pack bags

When using the sous-vide cooking method, only use heat-resistant vacuum-pack bags designed for this purpose.

Do not cook the food in the bag you bought it in (e.g. portions of fish). These bags are not suitable for sous-vide cooking.

Vacuum sealing

Use a chamber vacuum-packing machine that can create a vacuum of at least 99% to vacuum-seal the food. This is the only way to achieve even heat transfer and therefore a perfect cooking result.

Before cooking the food, check whether the vacuum in the bag is intact. Make sure that:

- There is no/hardly any air in the vacuum-pack bag.
- The seam is perfectly sealed.
- There are no holes in the vacuum-pack bag. Do not use a core temperature probe.
- Pieces of meat and fish that have been vacuum-sealed together are not pressed directly against one another.
- As far as possible, you avoid piling up vegetables and desserts when vacuum-sealing them.

If in doubt, place the food into a new bag and vacuum-seal it again.

Food should be vacuum-sealed at most one day before it is cooked. This is the only way to prevent the escape of gases from the food (e.g. from vegetables) which inhibit the transfer of heat, or to prevent the texture of the food from changing, and thus altering how it cooks.

Quality of the food

The quality of the cooking result is 100% influenced by the quality of the ingredients you use. Use only fresh, top-quality food. This is the only way to guarantee a consistent cooking result that delivers impeccable flavor.

Preparation

Sous-vide cooking prevents flavors from escaping, intensifying the food's natural flavor. Please note that the usual quantities of seasoning and condiments, such as herbs, spices and garlic, will have a much greater effect on the flavor. Start off by halving the quantities you usually use.

If the ingredients are of high quality, it is often sufficient to enclose them in the bag with just a small piece of butter and a little salt and pepper. Generally, the fact that the food's natural flavors intensify during cooking is sufficient on its own to produce a flavorful cooking result.

Do not place the vacuum-sealed food items on top of one another or too close together in the cooking containers. In order to ensure that the heat is distributed evenly, the food items should not be touching. If you have more than one vacuum-pack bag, cook on two levels.

Remove the vacuum-pack bags with care after cooking as hot water accumulates on the bags. Place the unperforated cooking container on the rack underneath the perforated cooking container containing the hot food.

Dry the outside of the bag, place it into a clean, unperforated cooking container and cut it open with scissors. Place all of the food, along with its juices, into the cooking container.

The food can be finished off as follows once the sous-vide cooking stage is complete:









Meat: Flash fry at a very high temperature for a few seconds only on each side. This gives it a nice crust and the flavors you would expect from frying, without overcooking it. You can achieve a particularly good result using a teppan yaki or a grill. Important: Dab the meat with a paper towel before placing it into hot oil, in order to avoid fat spitting out of the pan.

















Vegetables: Flash fry in a frying pan or on a teppan yaki to give them the flavors you would expect from frying. When frying vegetables like this, it is easy to season them or mix them with other ingredients without them cooling down.







Fish: Season and coat with hot butter. Since many types of fish fall apart easily after cooking using the sous-vide method, if you wish to flash fry it, this should be done before the sous-vide cooking stage.

Fry the food for longer if has not been sufficiently well cooked during the sous-vide cooking stage.





Serve the food on pre-heated plates and, if possible, with a hot sauce or butter as sous-vide cooking takes place at relatively low temperatures.















Food	Cooking container	Temperature in °F (°C)	Type of heating	Cooking time in min.	Observations
Meat					
Entrecôte, rare (180 g / 6 oz)	perforated	135 (58)		100	Once the meat is cooked, flash fry it on a teppan yaki or grill it at a high temperature on both sides. This gives the meat a nice crust and the flavors you would expect from frying, without overcooking it.
Entrecôte, medium rare (180 g / 6 oz)	perforated	145 (63)		90	
Entrecôte, well done (180 g / 6 oz)	perforated	160 (70)		85	
Veal topside steaks (160 g / 5½ oz)	perforated	140 (60)		80	
Beef steaks, rare (180 g / 6 oz)	perforated	135 (58)		60	
Beef steaks, medium rare (180 g / 6 oz)	perforated	145 (63)		50	
Beef steaks, well done (180 g / 6 oz)	perforated	160 (70)		45	
Pork medallions (80 g / 3 oz)	perforated	145 (63)		75	
Poultry					
Duck breast (350 g / 12 oz)	perforated	135 (58)		70	Once the breast is cooked, fry the skin side in a hot frying pan until it is crispy.

Food	Cooking container	Temperature in °F (°C)	Type of heating	Cooking time in min.	Observations
Foie gras (300 g / 11 oz / 1 round)	perforated	175 (80)		30	Recipe tip: Wash the goose liver and mix it with other ingredients. Roll it in foil and prick it several times. Vacuum-seal the round and leave it to chill for several hours in the refrigerator before cooking it using the sous-vide method.
Chicken breast (250 g / 9 oz)	perforated	150 (65)		60	
Fish and Seafood					
Prawns (125 g / 4½ oz)	perforated	140 (60)		30	Recipe tip: Vacuum-seal along with some olive oil, salt and garlic.
Scallops (20 - 50 g / piece) (1 - 2 oz / piece)	perforated	140 (60)		6 - 10	The more the scallops weigh, the longer the chosen cooking time should be.
Cod (140 g / 5 oz)	perforated	140 (59)		25	
Salmon fillet (140 g / 5 oz)	perforated	135 (58)		30	If you wish, you can flash fry the salmon fillet in a hot frying pan once it is cooked.
Pike-perch (140 g / 5 oz)	perforated	140 (60)		20	
Vegetables					
Mushrooms, quartered (500 g / 1 lb 2 oz)	perforated	185 (85)		20	Recipe tip: Vacuum-seal along with some butter, rosemary, garlic and salt.
Chicory, halved (4 - 6 pieces)	perforated	185 (85)		40	Recipe tip: Cut the chicory in half. Vacuum-seal along with some orange juice, sugar, salt, butter and thyme.
White asparagus, whole (500 g / 1 lb 2 oz) Green asparagus, whole (600 g / 1 lb 5 oz)	perforated	185 (85)		45	Recipe tip: Blanch before vacuum-sealing to retain the color. Vacuum-seal along with some butter, salt and pepper.
Carrots, in slices 0.5 cm (600 g / 1 lb 5 oz)	perforated	200 (95)		15 - 20	Recipe tip: Vacuum-seal along with some orange juice, curry and butter.
Potatoes, peeled, in 2 x 2 cm cubes (800 g / 1 lb 12 oz)	perforated	200 (95)		35 - 40	Recipe tip: Vacuum-seal along with some butter and salt. Can easily be used for making dishes such as salad.
Potatoes, skin on, whole or halved (800 g / 1 lb 12 oz)	perforated	200 (95)		40	Recipe tip: Vacuum-seal along with some butter and salt. Wash thoroughly beforehand.
Cherry tomatoes, whole or halved (500 g / 1 lb 2 oz)	perforated	185 (85)		50	Recipe tip: Vacuum-seal along with some olive oil, salt and sugar. Mix together red and yellow cherry tomatoes.
Pumpkin, in 2 x 2 cm cubes (600 g / 1 lb 5 oz)	perforated	195 (90)		15	The cooking time may vary depending on the type of pumpkin.
Zucchini, in 1 cm slices (600 g / 1 lb 5 oz)	perforated	185 (85)		20 - 25	Recipe tip: Vacuum-seal along with some olive oil, salt and thyme.
Snap peas, whole (500 g / 1 lb 2 oz)	perforated	185 (85)		30	Recipe tip: Vacuum-seal along with some butter and salt.

Food	Cooking container	Temperature in °F (°C)	Type of heating	Cooking time in min.	Observations
Mushrooms, quartered (500 g / 1 lb 2 oz)	perforated	185 (85)		5 - 10	Recipe tip: Vacuum-seal along with some butter, rosemary, garlic and salt.
Dessert					
Pineapple in 1.5 cm slices (400 g / 14 oz)	perforated	185 (85)		70	Recipe tip: Vacuum-seal along with some butter, honey and vanilla.
Apple, peeled, in 0.5 cm slices (2 - 4 pieces)	perforated	185 (85)		10 - 15	Recipe tip: Vacuum-seal along with some caramel sauce.
Bananas, whole (2 - 4 pieces)	perforated	150 (65)		15 - 20	Recipe tip: Vacuum-seal along with some butter, honey and a vanilla pod.
Pear, peeled, sliced (2 - 4 pieces)	perforated	185 (85)		30	Recipe tip: Add honey or sugar to sweeten.
Kumquats, halved (12 - 16 pieces)	perforated	185 (85)		75	Recipe tip: Vacuum-seal along with some butter, a vanilla pod, honey and apricot jam. Rinse under warm water, cut in half and deseed.
Vanilla sauce (0.5 l / 2 cup)	perforated	180 (82)		18 - 20	Recipe tip: 0.5 l / 2 cup milk, 1 egg, 3 egg yolks, 80 g / 3 oz sugar, 1 vanilla pod.

Broiling

- A total of three broil functions mean that you can brown your food, broil it (full surface broil and air recirculation) – or do both at the same time in a single step (full surface broil level 1 + humidity and full surface broil, setting 2 + humidity).
 -  | Browning with full surface broil + air recirculation at 445° F (230 °C):
Also referred to as cooking au gratin. The last step in a cooking process. A brown crust forms on the surface of the food. Only takes a few minutes. The ingredients are already pre-cooked.
 -  | Full surface broil + air recirculation at 355 - 390° F (180–200 °C):
Complete cooking process whereby the surface is toasted. The cooking process is longer than when browning. The ingredients must not be pre-cooked.
 -  -  Browning + broiling with full surface broil level 1 + humidity and full surface broil level 2 + humidity:
With these two functions, food is simultaneously cooked and browned/two steps are carried out with one type of heating. The steam cooks the food, e.g. a potato gratin, and the second step browns it.
- Do not broil food with the oven door open.
- With the full surface broil and air recirculation function, a pre-heating time of five minutes is sufficient. You do not need to wait until the temperature is reached. With the full surface broil and air recirculation function, the selected temperature may differ from the actual temperature in the appliance. Broiling is a rapid cooking process at high temperatures. Consequently, for browning and roasting, a higher temperature than is actually needed on the surface of the food is always selected.
- If you use the core temperature probe with the full surface broil with air recirculation or humidity with full surface broil functions, make sure that the core temperature probe is at least 2 inches (5 cm) away from the broil element. Otherwise, the core temperature probe may be damaged.

Food	Cooking container, level	Temperature in °F (°C)	Type of heating	Cooking time in min.	Comments
Meringue topping (on cake/dessert)	Wire rack 2	445 (230)		3–8	
Open-face sandwich	Wire rack + unperforated 2	390 (200)		12–15	
Trout (whole)	Wire rack + unperforated 2	445 (230)		12–15 per side	Recipe tip: Dill with lemon slices and parsley.
Grilled eggplant, sliced	unperforated 2	390 (200)		20	
Grilled vegetables, 1.5 lb (700 g)	unperforated 2	445 (230)		20–25	e.g. zucchini
Vegetable bake	unperforated 2	375 (190)		30–35	e.g. with broccoli and cauliflower
Vegetable skewers	Wire rack + unperforated 2	445 (230)		15 per side	Cooking time depends on the types of vegetables.
Chicken legs, 0.7 lb (350 g) apiece	Wire rack + unperforated 2	355-390 (180–200)		35–40	
Hamburgers, 4.4 oz (125 g) in accordance with EN 60350-1	Wire rack + unperforated 2	445 (230)		12–15 per side	Preheat for 5 minutes
Potato gratin, 2.2 lb (1 kg) potatoes	Wire rack/ unperforated 2	355 (180)		45–65	
Lasagne	Wire rack 2	355 (180)		40–45	
Sweet potatoes, sliced	unperforated 2	390 (200)		15	
Toast in accordance with EN 60350-1	Wire rack 1	445 (230)		5–7	Preheat for 5 minutes.
Zucchini au gratin, stuffed, halved lengthwise	unperforated 2	355 (180)		30–40	

Side dishes

Food	Cooking container	Temperature in °F (°C)	Humidity in %	Cooking time in min.	Comments
Basmati rice, 0.5 lb + 2 cups (250 g + 500 ml) water	unperforated	212 (100)	100	20–25	
Bulgur wheat, 0.5 lb + 1 cup (250 g + 250 ml) water	unperforated	212 (100)	100	10–15	
Couscous, 0.5 lb + 1 cup (250 g + 250 ml) water	unperforated	212 (100)	100	10–15	

Food	Cooking container	Temperature in °F (°C)	Humidity in %	Cooking time in min.	Comments
Dumplings, 0.2 oz (90 g) apiece	perforated/unperforated	205-212 (95-100)	100	25-30	
Long-grain rice, 0.5 lb + 2 cups (250 g + 500 ml) water	unperforated	212 (100)	100	25-30	
Brown rice, 0.5 lb + 1.5 cups (250 g + 375 ml) water	unperforated	212 (100)	100	30-35	
Polenta 0.5 lb + 2.6 cups (250 g + 625 ml) water for hard polenta 0.5 lb + 4.6 cups (250 g + 1125 ml) water for soft polenta	unperforated	212 (100)	100	10-15	
Quinoa, 0.5 lb + 2 cups (250 g + 500 ml) water	unperforated	212 (100)	100	30-40	
Risotto, 0.5 lb + 3 cups (250 g + 750 ml) stock	unperforated	212 (100)	100	35-40	
Red beans	unperforated	212 (100)	100	85-95	Soak for 1 hour. Cover with water.
Red lentils 0.5 lb + 1.5 cups (250 g + 375 ml) water	unperforated	212 (100)	100	15-20	
Lentils, 0.5 lb + 1.5 cups (250 g + 375 ml) water	unperforated	212 (100)	100	50-60	
White beans, pre-softened, 0.5 lb + 4.1 cups (250 g + 1 l) water	unperforated	212 (100)	100	55-65	

Desserts





Food	Cooking container	Temperature in °F (°C)	Humidity in %	Cooking time in min.	Comments
Crème brûlée, 0.3 lb (130 g) apiece	perforated	175 (90)	80	55-65	
Steamed dumplings/yeast dumplings, 3.5 oz (100 g) apiece	unperforated	212 (100)	100	20-30	Allow steamed dumplings to rise for 30 minutes before steaming. → "Dough proving (leaving to rise)" on page 63
Flan/crème caramel, 0.3 lb (130 g) apiece	perforated	175 (90)	100	35-40	
Compote	unperforated	212 (100)	100	20-25	e.g. apples, pears, rhubarb Recipe tip: Add sugar, vanilla sugar, cinnamon or lemon juice.
Rice pudding 7 oz (200 g) rice + 3.3 cups (800 ml) milk	unperforated	212 (100)	100	55-60	Allow to cool down for 10 minutes and stir. Recipe tip: Add fruit, sugar or cinnamon.
Orange flan	perforated	175 (90)	100	40-45	

Food	Cooking container	Temperature in °F (°C)	Humidity in %	Cooking time in min.	Comments
Poached pears	perforated	212 (100)	100	45–50	
Sweet bake	unperforated	355-390 (180–200)	0/60	20–40	Preheat e.g. semolina, quark or pre-cooked rice pudding
Sweet soufflé	unperforated	320 (160)	0	30	With fruit, chocolate, vanilla

Other

Food	Cooking container	Temperature in °F (°C)	Humidity in %	Cooking time in min.	Comments
Disinfect (e.g. baby bottles, canning jars)	Wire rack	212 (100)	100	20–25	
Desiccating/drying fruit or vegetables	perforated	175-212 (80–100)	0	180–300	e.g. tomatoes, mushrooms, zucchini, apples, pears, etc. in thin slices
Eggs, hard-boiled	perforated	212 (100)	100	13–15	Preheat
Eggs, medium	perforated	212 (100)	100	7	Preheat
Eggs, soft-boiled	perforated	212 (100)	100	4	Preheat
Egg custard, 1.1 lb (500 g)	Glass pan, wire rack	195 (90)	100	25–30	
Semolina dumplings	unperforated	195-205 (90–95)	100	12–15	
Hot towels	unperforated	212 (100)	100	10–15	Moisten the towels.
Potato gratin, 2.2 lb (1 kg) potatoes	Ovenproof dish, wire rack	355 (180)	30	45–65	
Lasagne	unperforated	340-375 (170–190)	30/60	40–55	
Soufflé (cheese soufflé)	Soufflé dishes, wire rack	320 (160)	0	30	
Melting chocolate	Heat-resistant bowl, wire rack	140 (60)	100	15–20	Cover with heat-resistant plastic wrap.

Baked goods



- With the combination steam oven, you can always prepare your baked goods with the optimal humidity:
 -  | Convection and 0% humidity:
For cake with fruit topping and quiche, excess humidity can escape. This operation mode corresponds to the hot air in the conventional baking oven.
 -  | Convection and 30% humidity:
Sponge cakes do not dry out. The humidity in the food cannot escape from the oven cavity.
 -  | Convection + 60 - 100% humidity:
Puff pastry and yeast-risen pastry are fluffy inside and crispy outside, with a gloss.
- If you only bake on one level, use level 2. If you are baking on two levels at the same time, use levels 1 and 3. Insert the unperforated cooking insert at the second level. If you are using a high baking pan, place it on the wire rack that you insert at the first level.
- For misting - possible in convection mode (0% humidity) and with humidity level 30% - humidity is fed to the food by touching the  symbol. This function is used for example when baking bread or yeast cake at the beginning of the baking process. It produces more volume and a crispier and glossier crust.

Food	Cooking container	Temperature in °F (°C)	Humidity in %	Cooking time in min.	Comments
Apple cake (in accordance with EN60350-1)	Springform cake pan 20 cm, wire rack	320 (160)	0	110	Preheat
Bagels	unperforated	375-410 (190-210)	80-100	20-25	
Baguettes, pre-baked	Wire rack	375-390 (190-200)	0-80	10-15	
Sponge base, high (6 eggs)	Springform cake pan	300 (150)	0	45	
Sponge base, low (2 eggs)	unperforated	390 (200)	100	8-10	e.g. for Swiss roll
Puff pastry goods	unperforated	375-410 (190-210)	80-100	10-18	e.g. with poppy seed, marzipan or savory with ham, cheese
Brioche, rolls	unperforated	320 (160)	0	8-12	
Rolls, 1.7 - 3.5 oz (50-100 g) apiece	unperforated	1) 300 (150) 2) 340-445 (170-230)	100 30	10 25	Step 2) 340°F (170 °C) for light/445°F (230 °C) for dark
Rolls, pre-baked	Wire rack	300-340 (150-170)	0	8-15	Inject steam at the beginning.
Bread, 1.1-2.2 lb (0.5-1 kg)	unperforated	1) 300 (150) 2) 340-445 (170-230)	100 30	10 25-45	Step 2) 340°F (170 °C) for light/445°F (230 °C) for dark Use the core temperature probe to monitor the exact cooking temperature. → Page 30 Place on the wire rack to cool.
Flat cake of sponge batter	unperforated	320-330 (160-165)	0	35-40	
Bundt cake, 2.2 lb (1 kg) flour	Bundt cake pan, wire rack	320-340 (160-175)	30	45-50	
Yeast-risen sheet cake	unperforated	320-340 (160-170)	0-60	30-45	For yeast-risen sheet cakes with moist topping (e.g. plum cake or onion tart) 0% and with dry topping (e.g. streusel) 60% humidity.
Plaited loaf, 1.1 lb (500g) flour	unperforated	320-340 (160-170)	30	25-35	At the beginning: Inject steam once
Muffins	Muffin tin, wire rack	340 (170)	30	20-30	
Macaroons	unperforated	300-320 (150-160)	0	15-20	
Cookies	unperforated	300-330 (150-165)	0	10-20	
Quiche, flan	Quiche pan, wire rack	375-410 (190-210)	0	45-60	
Sponge cake	Loaf pan/ springform cake pan, wire rack	330-340 (165-170)	0-30	50-75	

Food	Cooking container	Temperature in °F (°C)	Humidity in %	Cooking time in min.	Comments
Small cakes (in accordance with EN60350-1)	unperforated – level 2	320 (160)	0	25–30	Preheat
	perforated – level 1	300 (150)	0	30–35	
	unperforated – level 3				
Viennese whirls (in accordance with EN60350-1)	unperforated – level 2	285 (140)	0	50	Preheat
	perforated – level 1	285 (140)	0	50	
	unperforated – level 3				
Tart	Tart pan, wire rack	375-390 (190–200)	0–30	30–45	e.g. with apples, chocolate, apricots or savory with asparagus, onions, cheese
Hot water sponge cake (in accordance with EN60350-1)	unperforated	300 (150)	0	40	Preheat
Cream puffs, eclairs	unperforated	355-375 (180–190)	0–30	40–45	







Dough proving (leaving to rise)

- The combination steam oven offers the ideal climate for letting rise and making baked goods without drying out.
- Use the heating mode "Dough proofing" .
- With this type of heating, preheating is not necessary.
- The bowl does not have to be covered with a damp cloth. Rising takes only half as long as in the usual way.
- The suggested cooking time is only a guideline. Let the dough rise until its volume has doubled.

Food	Cooking container	Temperature in °F (°C)	Type of heating	Cooking time in min.	Observations
Dough mixture- pizza	Bowl/ wire rack	100 (38)		25	e.g. yeast dough, natural fermentation starter, sourdough
Dough mixture - brea t	Bowl/ wire rack	115 (45)		40	
Dough mixture - brioche	Bowl/ wire rack	115 (45)		55	

Refreshing (warming up)

- The combi-steam oven creates the perfect environment for reheating cooked food without drying it out. The flavour and quality are virtually indistinguishable from food that has been freshly prepared.
- To use this function, select "Reheat" mode .
- Do not cover the food. Do not use aluminium foil or clingfilm.
- The figures listed are for portions for one person. Larger quantities of food can also be warmed up in the unperforated cooking insert; you will need to cook the food for longer than the times specified in the table.

Food	Cooking container	Temperature in °F (°C)	Type of heating	Cooking time in min.	Observations
Baguettes, rolls (frozen)	Wire rack	285 (140)		10 - 15	
Baguettes, rolls (day-old)	Wire rack	355 (180)		4 - 7	
Roast, in slices (5 oz / 150 g)	unperforated	250 (120)		15 - 20	Finger-thick slices, do not place on top of each other, to keep juicy, add sauce to the cooking container.
Vegetables	Plate, wire rack	250 (120)		10 - 12	Preheat.
Pizza (from previous day, not deep-frozen)	Wire rack	355 (180)		8 - 10	
Starchy side dishes	Plate, wire rack	250 (120)		8 - 12	e.g. noodles, potatoes, rice, not suitable are baked or fried foods such as french fries or croquettes
Plated meals	Plate, wire rack	250 (120)		15 - 20	

Defrosting

- In the steam oven you can gently and evenly thaw deep frozen foods faster than at in the fridge or microwave.
- Use the "Defrosting" mode  to do this.
- With this mode preheating is not necessary.
- The specified thawing times are for your orientation only. The time it takes to thaw depends on the size and weight of the frozen food: freeze your foods flatly or individually. This shortens the thawing time.
- Take foods out of the packaging before thawing them.
- Thaw only the amount you immediately need.
- Remember: in certain circumstances, thawed food does not keep so well and goes bad faster than fresh food. Immediately process thawed food and cook it thoroughly.
- After half of the thawing time, turn meat or fish over fish or separate fragmentary frozen food such as berries or bits of meat. Fish need not thaw fully. It suffices if the surface is soft enough to absorb the spices.

WARNING

Health risk!

When thawing animal foodstuffs, it is imperative to remove the liquid that arises during thawing. It must never come into contact with other foodstuffs. Germs could be transmitted.

Slide the unperforated cooking insert underneath the food. Pour away the collected thawing liquid from meat and poultry. Then clean the sink and rinse with plenty of water. Clean the cooking insert in hot soapy solution or in a dishwasher.

After defrosting, operate the steam oven for 15 minutes with Convection at 350 °F (180°C).

Food	Cooking container	Temperature in °F (°C)	Type of heating	Cooking time in min.	Observations
Berries (300 g / 11 oz)	perforated	115 - 120 (45 - 50)	* ◊	6 - 8	
Roast (1 - 1.5 kg / 2 lb 4 oz - 3½ lb)	perforated	115 - 120 (45 - 50)	* ◊	90 - 120	
Fish fillet (150 g / 5 oz each)	perforated	115 - 120 (45 - 50)	* ◊	15 - 20	
Vegetables (400 g / 14 oz)	perforated	115 - 120 (45 - 50)	* ◊	10 - 12	
Goulash (600 g / 1 lb 5 oz)	perforated	115 - 120 (45 - 50)	* ◊	40 - 55	
Chicken (1 kg / 2 lbs 4 oz)	perforated	115 - 120 (45 - 50)	* ◊	60 - 70	
Chicken legs (400 g / 14 oz each)	perforated	115 - 120 (45 - 50)	* ◊	40 - 50	

Preserving

- In combination steam ovens, you can can fruit and vegetables with little effort.
- If possible, cook food immediately after purchase or harvesting. Longer storage decreases the vitamin content and can cause spoilage.
- Only use fruit and vegetables in good condition.
- The combination steam oven is not suited for preserving meat.
- Check and clean the canning jars, rubber rings, clamps, and springs carefully.
- You can disinfect the clean jars in your combination steam oven at 212°F (100 °C) and 100% humidity for 20 - 25 min before you preserve the fruit in them.
- Place the jars in the perforated cooking container. They must not be in contact with each other.
- Open the cooking compartment door after the cooking time has elapsed. Do not remove the canning jars from the appliance until they have completely cooled down.

Food	Cooking container	Temperature in °F (°C)	Humidity in %	Cooking time in min.	Observations
Fruit, vegetables (in closed ½ pint / 0.75 l canning jars)	perforated	212 (100)	100	35 - 40	
Beans, peas (in closed ½ pint / 0.75 l canning jars)	perforated	212 (100)	100	120	

Extracting juice (soft fruits)

- You can effortlessly and cleanly extract berry juice in the steam oven.
- Place the berries in the perforated cooking insert and slide it into the second level from below. Slide in the unperforated cooking insert one level below it to collect the liquid.
- Leave the berries in the appliance until no more juice appears.
- You can then squeeze the berries dry in a dishtowel to preserve the last remainders of juice.

Food	Cooking container	Temperature in °F (°C)	Humidity in %	Cooking time in min.	Observations
Berries	perforated + unperforated	212 (100)	100	60 - 120	

Preparing yoghurt

- You can prepare your own yogurt in the combination steam oven.
- Heat pasteurized milk to 195°F (90°C) on the cooktop in order to prevent a disturbance of the yogurt cultures. Ultra-high-heated milk (H-milk) does not have to be heated. (Note: if you want to make yogurt with cold milk, the resting period is longer).
- Important! Leave milk cool to 105°F (40°C) in the water bath so as not to destroy the yogurt cultures.
- Stir natural yogurt with active yogurt cultures into the milk (1 - 2 teaspoons of yoghurt for every 1/2 cup / 100 ml).
- For yogurt enzymes, follow package instructions.
- Fill the yogurt into clean jars.
- You can disinfect the clean jars in your combination steam oven at 212°F (100°C) and 100% humidity for 20 - 25 min before you pour the yogurt in. Make sure to let the jars and the oven cavity cool off before you pour the yogurt into them and place the jars in the appliance.
- After preparation, put the yogurt in the refrigerator.
- To make thicker yogurt, add skin milk powder to the milk before heating (1-2 tablespoons per liter).

Food	Cooking container	Temperature in °F (°C)	Humidity in %	Cooking time in min.	Observations
Yogurt approach (in sealed jars)	perforated	115 (45)	100	300	Recipe tip: Add fruit puree, jam, honey, vanilla or chocolate to the yogurt approach to flavor it.

Preparing bulky food

- For the preparation of bulky foods, you can also remove the side slide-in tray.
- To do this, loosen the knurled screws at the front of the slide-in tray and pull the tray out toward the front.
- Place the wire rack directly on the bottom of the cooking compartment and place the food or the roasting dishes on the wire rack. Do not place the food or the roasting dishes directly on the enameled bottom.

Acrylamide in foodstuffs

Which foods are affected?

Acrylamide is mainly produced in grain and potato products that are heated to high temperatures, such as chips, fries, toast, rolls, bread, fine baked goods (cookies, gingerbread, Christmas spice cookies).

Tips for keeping acrylamide to a minimum when preparing food

General	Keep cooking times as short as possible. Cook food until it is golden brown, but not too dark. Large, thick pieces of food contain less acrylamide.
Baking	With hot air at max. 355° F (180 °C).
Cookies	Egg or egg yolk reduces the production of acrylamide. Spread out a single layer evenly on the baking tray.
Oven French fries	Cook at least 400 g at once on a baking tray so that the fries do not dry out.

Gaggenau
BSH Home Appliance Corporation
1901 Main Street, Suite 600
Irvine, CA 92614
1-877-442-4436

www.gaggenau.com/us
© 2020 BSH Home Appliances

Gaggenau Hausgeräte GmbH
Carl-Wery-Straße 34
81739 München
GERMANY



9001474923 (001127)
en-us

GAGGENAU