

FRIGIDAIRE

All about the

Use & Care

of your Microwave Oven



TABLE OF CONTENTS

Welcome & Congratulations	2	Sensor Operations.....	13
Important Safety Instructions	3	Care & Cleaning.....	15
Features & Specifications	7	Before You Call.....	16
Before Operating.....	8	Warranty.....	18
Manual Operation.....	9		



Welcome & Congratulations

Questions?

1-800-347-4432

(United States)

1-800-265-8352

(Canada)

Please attach sales receipt here for future reference.

Congratulations on your purchase of a new microwave oven! At **Electrolux Home Products**, we are very proud of our product and are completely committed to providing you with the best service possible. Your satisfaction is our number one priority.

We know you'll enjoy your new microwave oven and **Thank You** for choosing our product. We hope you consider us for future purchases.

PLEASE CAREFULLY READ AND SAVE THESE INSTRUCTIONS

This Use & Care Manual provides specific operating instructions for your model. Use your microwave oven only as instructed in this manual. These instructions are not meant to cover every possible condition and situation that may occur. Common sense and caution must be practiced when installing, operating and maintaining any appliance.

Please record your model and serial numbers below for future reference.

Model Number: _____

Serial Number: _____

Purchase Date: _____

NEED HELP?

Visit the Frigidaire Web Site at: <http://www.frigidaire.com>

Before you call for service, there are a few things you can do to help us serve you better.

Read this manual.

It contains instructions to help you use and maintain your microwave oven properly.

If you received a damaged Microwave Oven... immediately contact the dealer (or builder) that sold you the Microwave Oven.

Save time and money.

Check the section titled "Service Call Check". This section helps you solve common problems that might occur. If you do need service, you can relax knowing help is only a phone call away. A list of toll-free customer service numbers is included in the back of this manual. Or call Frigidaire Customer Services at 1-800-944-9044, 24 hours a day, 7 days a week.

For your safety the information in this manual must be followed to minimize the risk of fire or explosion or to prevent property damage, personal injury or loss of life.

PRECAUTIONS TO AVOID POSSIBLE EXPOSURE TO EXCESSIVE MICROWAVE ENERGY

- (a) Do not attempt to operate this oven with the door open since open-door operation can result in harmful exposure to microwave energy. It is important not to defeat or tamper with the safety interlocks.
- (b) Do not place any object between the oven front face and the door or allow soil or cleaner residue to accumulate on sealing surfaces.
- (c) Do not operate the oven if it is damaged. It is particularly important that the oven door close properly and that there is no damage to the: (1) door (bent), (2) hinges and latches (broken or loosened), (3) door seals and sealing surfaces.
- (d) The oven should not be adjusted or repaired by anyone except properly qualified service personnel.



IMPORTANT SAFETY INSTRUCTIONS



WARNING

When using electrical appliances, basic safety precautions should be followed to reduce the risk of burns, electric shocks, fire or injury to persons or exposure to excessive microwave energy.

1. **READ ALL** instructions before using oven.
2. **READ AND FOLLOW** the specific "PRECAUTIONS TO AVOID POSSIBLE EXPOSURE TO EXCESSIVE MICROWAVE ENERGY" on page 2.
3. This appliance must be grounded. Connect only to properly grounded outlet. See **GROUNDING INSTRUCTIONS** found on Page 5
4. Install or locate this oven **ONLY** in accordance with the installation instructions in this Use & Care Manual.
5. Some products such as whole eggs and sealed containers -(for example, closed jars) -are able to explode and **SHOULD NOT** be **HEATED** in this oven.
6. Use this oven **ONLY** for its intended use as described in this Use & Care Manual. Do not use corrosive chemicals or vapors in this oven. This type of oven is specifically designed to heat, cook, or dry food. It is not designed for industrial or laboratory use.
7. This appliance should not be used by children.
8. **DO NOT** operate this oven if it has a damaged cord or power plug, if it is not working properly, or if it has been damaged or dropped.
9. This oven, including power cord, must be serviced **ONLY** by qualified service personnel. Special tools are required to service oven. Contact nearest authorized service facility for examination, repair, or adjustment.
10. **DO NOT** cover or block any vents or openings on the oven.
11. **DO NOT** store this oven outdoors. **DO NOT** use this appliance near water -(for example, near a kitchen sink, in a wet basement, near a swimming pool or similar locations).
12. **DO NOT** immerse cord or plug in water.
13. Keep cord **AWAY** from **HEATED** surfaces.
14. **DO NOT** let cord hang over edge of table or counter.
15. Review the door cleaning instructions in the Care & Cleaning section on page 15.
16. To avoid the risk of fire in the oven cavity, injury to persons, or exposure to excessive microwave energy.
 - a. **DO NOT overcook** food. Carefully attend oven when paper, plastic or other combustible materials are placed inside the oven to facilitate cooking.
 - b. Remove wire twist-ties from paper or plastic bags before placing bag in oven.
 - c. If materials inside the oven ignite, keep oven door **CLOSED**, turn oven off and disconnect the power cord, or shut off power at the fuse or circuit breaker panel.
 - d. **DO NOT** use this oven cavity for storage. **DO NOT** leave paper products, cooking utensils or food in the cavity when not in use.
17. **Liquids** such as water, coffee, or tea can be overheated beyond the boiling point without appearing to be boiling due to surface tension of the liquid. Visible bubbling or boiling when the container is removed from the microwave oven is not always present. **THIS COULD RESULT IN VERY HOT LIQUIDS SUDDENLY BOILING OVER WHEN A UTENSIL IS INSERTED INTO THE CONTAINER OR LIQUID.**
18. **DO NOT** heat baby bottles in oven.
19. Jars must be open when heated and the contents stirred or shaken before consumption, in order to avoid burns.
20. **DO NOT** use this oven for commercial purposes. It is made for household use only.

SAVE THESE INSTRUCTIONS

What You Need to Know About Safety Instructions

Warning and Important Safety Instructions appearing in the Use & Care Guide are not meant to cover all possible conditions and situations that may occur. Common sense, caution, and care must be exercised when installing, maintaining or operating a microwave.

Always contact your dealer, distributor, service agent or manufacturer about problems or conditions you do not understand.

Recognize Safety Symbols, Words, Labels



DANGER

DANGER - Immediate hazards which **WILL** result in severe personal injury or death.



WARNING

WARNING - Hazards or unsafe practices which **COULD** result in severe personal injury or death.



CAUTION

CAUTION - Hazards or unsafe practices which **COULD** result in minor personal injury.



CAUTION

To avoid personal injury or property damage, observe the following:

1. Do not deep fat fry in oven. Fat could overheat and be hazardous to handle.
2. Do not cook or reheat eggs in shell or with an unbroken yolk using microwave energy. Pressure may build up and erupt. Pierce yolk with fork or knife before cooking.
3. Pierce skin of potatoes, tomatoes, and similar foods before cooking with microwave energy. When skin is pierced, steam escapes evenly.
4. Do not operate oven without load or food in oven cavity.
5. Use only popcorn in packages designed and labeled for microwave use. Popping time varies depending on oven wattage. Do not continue to heat after popping has stopped. Popcorn will scorch or burn. Do not leave oven unattended.
6. Do not use regular cooking thermometers in oven. Most cooking thermometers contain mercury and may cause an electrical arc, malfunction, or damage to oven.
7. Do not use metal utensils in oven.
8. Never use paper, plastic, or other combustible materials that are not intended for cooking.
9. When cooking with paper, plastic, or other combustible materials, follow manufacturer's recommendations on product use.
10. Do not use paper towels which contain nylon or other synthetic fibers. Heated synthetics could melt and cause paper to ignite.
11. Do not heat sealed containers or plastic bags in oven. Food or liquid could expand quickly and cause container or bag to break. Pierce or open container or bag before cooking.
12. To avoid pacemaker malfunction, consult physician or pacemaker manufacturer about effects of microwave energy on pacemaker.

⚠ WARNING

Improper use of the grounding can result in electric shock. To avoid risk of electrical shock or death, this oven must be grounded and plug must not be altered.

GROUNDING INSTRUCTIONS

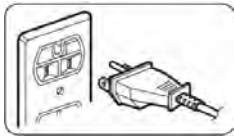

Oven MUST be grounded.

In the event of an electrical short circuit, grounding reduces risk of electric shock by providing an escape wire for the electric current.

This oven is equipped with a cord

having a grounding wire with a grounding plug. The must plugged into an outlet that is properly installed and grounded. See installation instructions.

Consult a qualified electrician or servicer if grounding instructions are not completely understood, or if doubt exists as to whether the oven is properly grounded.

If it is necessary to use an extension cord, use only a 3-wire extension cord that has a 3-pronged grounding plug and a 3-slot. This oven should be plugged into a separate 60 hertz circuit with the electrical rating as shown in specifications table. When the oven is on a circuit with other equipment, an increase in cooking times may be required and fuses can be blown.

Microwave operates on standard household current, 120V.

⚠ WARNING

- a. A short power-supply cord is provided to reduce the risks resulting from becoming entangled in or tripping over a longer cord.
- b. Longer cord sets or extension cords may be used if care is exercised in their use.
- c. If a long cord or extension cord is used:
 1. The marked electrical rating of the cord set or extension cord set should be at least as great as the electrical rating of the appliance.
 2. The extension cord must be a grounding-type 3-wire cord.
 3. The longer cord should be arranged so that it will not drape over the countertop or tabletop where it can be tripped over, snagged, or pulled on by children or tripped over unintentionally.

Federal Communications Commission Radio Frequency Interference Statement (U.S.A. Only)

This equipment generates and uses ISM frequency energy and if not installed and used properly, that is in strict accordance with the manufacturer's instructions, may cause interference to radio and television reception. It has been type tested and found to comply with limits for ISM Equipment, pursuant to part 18 of FCC Rules, which are designed to provide reasonable protection against such interference in a residential installation.

However, there is no guarantee that interference will not occur in a particular installation. If this equipment does cause interference to radio or television reception, which can be determined by turning the equipment off and on, the user is encouraged to try to correct the interference by one or more of the following:

Reorient the receiving antenna of the radio or television.

Relocate the microwave oven with respect to the receiver.

Move the microwave oven away from the receiver.

Plug the microwave oven into a different outlet so that the microwave oven and the receiver are on different branch circuits.

The manufacturer is not responsible for any radio or television interference caused by unauthorized modification to this microwave oven. It is the responsibility of the user to correct such interference.

Radio Interference

1. Operation of the microwave oven may cause interference to your radio, TV or similar equipment.
2. When there is interference, it may be reduced or eliminated by taking the following measures:
 - 1) Clean door and sealing surface of the oven
 - 2) Reorient the receiving antenna of radio or television.
 - 3) Relocate the microwave oven with respect to the receiver.
 - 4) Move the microwave oven away from the receiver.
 - 5) Plug the microwave oven into a different outlet so that microwave oven and receiver are on different branch circuits.

This MWO may be adapted to a built-in installation by using Trim Kit (GMTK3068AF/GMTK2768AF/GMTK3068AD/GMTK2768AD), refer to Trim Kit Installation Instruction for details.



WARNING

Liquids such as water, coffee, or tea can be overheated beyond the boiling point without appearing to be boiling due to surface tension of the liquid. Visible bubbling or boiling when the container is removed from the microwave oven is not always present. **THIS COULD RESULT IN VERY HOT LIQUIDS SUDDENLY BOILING OVER WHEN THE CONTAINER IS DISTURBED OR A UTENSIL IS INSERTED INTO THE LIQUID.**

To reduce the risk of injury to persons:

1. **Do not** overheat the liquid.
2. Stir the liquid both before and halfway through heating it.
3. **Do not** use straight-sided containers with narrow necks.
4. After heating, allow the container to stand in the microwave oven for a short time before removing the container.
5. Use extreme care when inserting a spoon or other utensils into the container.

Counter Top Installation

1. Select a level surface that provide enough open space for the intake and/or outlet vents.

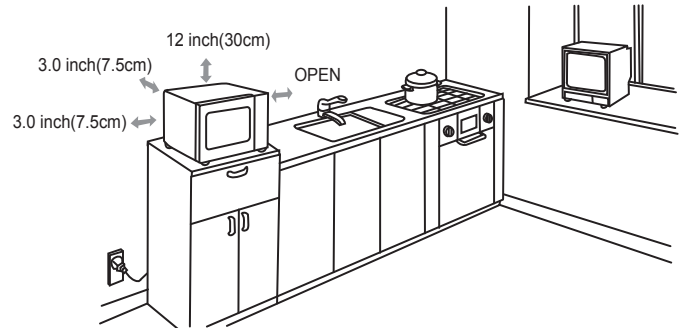

A minimum clearance of 3.0 inches (7.5cm) is required between the oven and any adjacent walls. One side must be open.

- (1) Leave a minimum clearance of 12 inches (30cm) above the oven.
- (2) Do not remove the legs from the bottom of the oven.
- (3) Blocking the intake and/or outlet openings can damage the oven.
- (4) Place the oven as far away from radios and TV as possible. Operation of microwave oven may cause interference to your radio or TV reception.
- (5) Plug your oven into a standard household outlet. Be sure the voltage and the frequency is the same as the voltage and the frequency on the rating label.

Sold Separately

Built-in Trim Kit allows for the installation of microwaves listed below to be built into a cabinet or wall by itself or over an electric self-clean or non self-clean single cavity wall oven.

See both wall oven and trim kit installation instructions

Model Number	Color	Description
GMBS3068AF	Easy Care SS	Microwave
GMBS3068AD	Black SS	Microwave
GMTK3068AF	Easy Care SS	30" Trim Kit
GMTK2768AF	Easy Care SS	27" Trim Kit
GMTK3068AD	Black SS	30" Trim Kit
GMTK2768AD	Black SS	27" Trim Kit

Features & Specifications



Microwave features

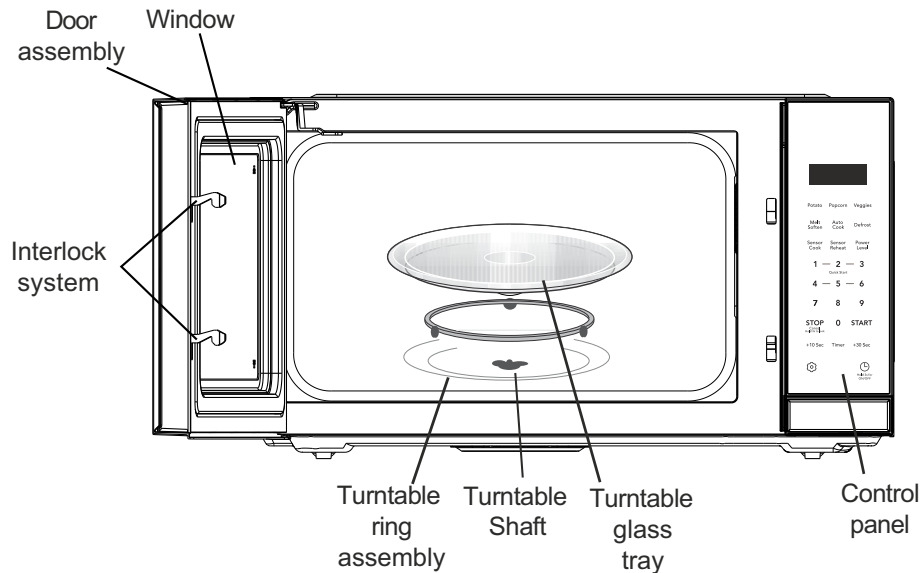

Control panel

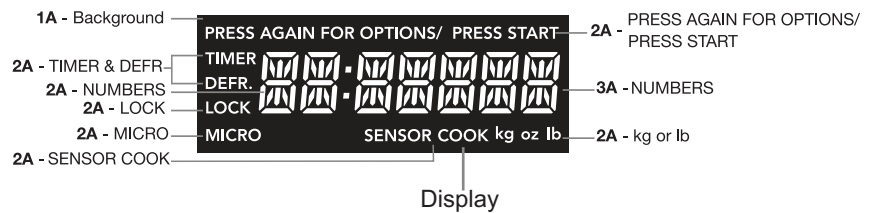
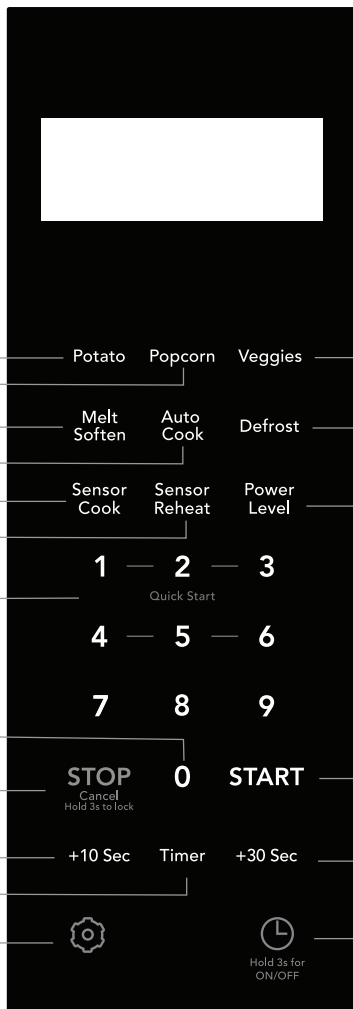

- (1) Potato
- (2) Popcorn
- (3) Melt/Soften
- (4) Auto Cook
- (5) Sensor Cook
- (6) Sensor Reheat
- (7) Veggies
- (8) Defrost
- (9) Power level (10 power levels available)
- (10) Number Keys
- (11) Stop/Cancel(Hold 3s to lock): clears all previous settings pressed before cooking starts.
During cooking: press once to stop oven; twice to stop and clear all entries.
- (12) +10 Sec
- (13) Timer
- (14) User Pref
- (15) Start
- (16) +30Sec
- (17) Clock(Hold 3s for on/off)



Before Operating

Learn more about your microwave oven

CAUTION

To avoid risk of personal injury or property damage, do not operate the microwave oven empty.

To avoid risk of personal injury or property damage, do not use stoneware, aluminum foil, metal utensils, or metal trimmed utensils in the microwave oven.

Microwave utensil guide



Use	Do not use
<ul style="list-style-type: none"> • Oven proof glass (specifically treated for high intensity heat): Utility dishes, loaf dishes, pie plates, cake plates, liquid measuring cups, casseroles and bowls without metallic trim. • China: Bowls, cups, serving plates and platters without metallic trim. • Plastic: Plastic must be rated as microwave-safe. Plastic wrap (as a cover) - lay the plastic wrap loosely over the dish and press it to the sides. Vent plastic wrap by turning back one edge slightly to allow excess steam to escape. The dish should be deep enough so that the plastic wrap will not touch the food. Use plastic dishes, cups, semi-rigid freezer containers and plastic bags for short cooking times. Use these with care because the plastic may soften from the heat of the food. Look for the manufacturer's label for any special instructions for use in the microwave oven. • Paper: Paper towels, waxed paper, paper napkins and paper plates with no metallic trim or design. Look for the manufacturer's label for any special instructions for use in the microwave oven. 	<ul style="list-style-type: none"> • Metal utensils: Metal shields the food from microwave energy and produces uneven cooking. Also, avoid metal skewers, thermometers or foil trays. Metal utensils can cause arcing, which can damage your microwave oven. • Metal decoration: Bowls, cups, serving plates and platters with metallic trim. • Aluminum foil: Avoid aluminum foil. • Wood: Wooden bowls and boards will dry out and may split or crack when you use them in the microwave oven. Baskets made of wood will react in the same way. • Tightly covered utensils: Be sure to leave openings for steam to escape from covered cookware. Pierce plastic pouches of vegetables or other food items before cooking. Tightly closed pouches may explode. Look for the manufacturer's label for any special instructions for use in the microwave oven. • Brown paper: Avoid using brown paper bags. They absorb heat and can burn. • Flawed or chipped cooking utensils: Any utensil that is cracked, flawed or chipped may break in the oven. • Metal twist ties: Remove metal twist ties from plastic or paper bags. They become hot and could cause a fire.

Manual Operation





Setting the clock

Example: setting clock display for 9:00:

1. Touch  pad once. 
Hold 3s for ON/OFF
2. Enter time using number pads. **9 0 0**
3. Touch **START** pad. **START**



Setting the clock ON/OFF

Clock display ON default.

1. Touch  and hold pad. 
Hold 3s for ON/OFF
2. Time will display, after 3s, OFF will display. **OFF**

NOTE

When the clock display off:

Press the  button 
Hold 3s for ON/OFF to enter the clock query state and return to the standby mode after 1 second. The clock is not displayed.

Hold down the  key for 1-3 seconds to display the current clock. After 1 second, display the current clock and enter the clock setting mode.

Setting the timer

Example: setting timer for 5 minutes:

1. Touch **Timer** pad once. **Timer**
2. Enter desired time using number pads. **5 0 0**
3. Touch **Timer** pad. **Timer**

Timer count down does not stop even if the door is opened. To stop/cancel the timer, press the **Timer** key once. When the timer has reached the end of set time, you will hear beep alerts indicating the timer has run out.

Control Lock

You may lock the control panel to prevent the microwave from being accidentally started or used by children.

The control lock feature is very useful when cleaning the control panel. The lock will prevent accidental programming when wiping the control panel clean.

Example: to set the control lock ON:

Touch and hold the **Stop/Cancel** pad for more than 3 seconds. The Lock icon will appear in the display window along with 1 beep.

STOP
Cancel
Hold to lock

Example: to change the control lock from ON to OFF:

Touch and hold the **Stop/Cancel** pad for more than 3 seconds. The Lock icon will disappear in the display window.

STOP
Cancel
Hold to lock

Using the +10 sec /+ 30 sec key

This feature will let you quickly start or add 10 or 30 seconds.

Touch the **+10 sec /+30 sec** pad to : **+10 Sec / +30 Sec**

1. Start programmed cooking.
2. Start cooking for 10 seconds/30 seconds at 100% power level.
3. Extend cooking time in multiples of 10 seconds/30 seconds each time this pad is touched during microwave cooking.

Example: to add 1 minute of cook time during 100% microwave cooking :

Press **+30 sec** pad twice. **+30 Sec**

NOTE

"Food" will be displayed if a quick start cooking cycle or +10 Sec / +30 Sec key is pressed more than 5 minutes after the door of microwave oven is closed. You must open then close the door again to clear "Food" from the display.



Manual Operation

Using Quick Start

1 — 2 — 3
Quick Start
4 — 5 — 6

Microwave heating or cooking may be quickly set at 100% power level for 1-6 minutes. Use the number keys 1-6 to choose the desired minutes of cook time (this option will only work using the 1-6 numeric pads).

Example: to quickly heat for 2 minutes at 100% power:

Press number pad for desired minute(s). The microwave will start at once. **2**

Heating with high power level

Example: to heat for 5 minutes and 30 seconds at 100% power:

1. Use the number pads to enter desired heating time. **5 3 0**

NOTE: For time sets that start with numbers 1 - 6, the remaining numbers must be entered within 2 second from the first key press, otherwise the Quick Start time will be used.

2. Press **START** pad. **START**

When finished, you will hear a series of beeps.

Heating with lower power levels

Using the highest power level to heat foods does not always give the best results when some types of food need slower cooking, such as roasts, baked goods or custards. Your oven has nine other power levels you may choose.

Example: to heat for 4 minutes and 30 seconds at 70% power:

1. Enter cook time. **4 3 0**
2. Press Power Level pad once for power level PL-HI. **Power Level**
3. Press Power Level four times to change to 70% power level. PL-70 appears in the display.

NOTE: For time sets that start with numbers 1 - 6, the remaining numbers must be entered within 2 second from the first key press, otherwise the Quick Start time will be used.

4. Press **START** pad. **START**

When finished, you will hear a series of beeps.

Manual Operation



Heating with multiple cooking stages

For best results, some microwave recipes call for different power levels or different lengths of time for cooking. Your microwave may be set to change from one stage to another automatically (2 stages maximum).

Example: to cook food at 80% power for 3 minutes and then 50% power for 6 minutes 30 seconds:

1. Use the number pads to enter heating time for the 1st stage. **3 0 0**
2. Press **Power Level** pad. Power Level
3. Press Power Level three times to change to 80% power level. PL-80 appears in the display.
4. Use the number pads to enter heating time for the 2nd stage. **6 3 0**
5. Press **Power Level** (within 1 second) for the 2nd stage. Power Level
6. Press Power Level six times to change to 50% power level for the 2nd stage. PL-50 appears in the display.
7. Press **START** pad. **START**

When finished, you will hear a series of beeps.

NOTE:

The "Convenience operation" can't be set as one of multiple cooking.

Auto Cook

Do not leave microwave unattended during any of auto cook selections.

Key Press	Food	Amount	Key
Auto Cook x1	Bacon	1 - 3 slices	1 - 3
Auto Cook x2	Frozen Entrée	10 oz 20 oz	-
Auto Cook x3	Rice	1 cup 2 cups	-

Example: to cook Rice.

1. Press **Auto Cook** pad 3 times. Auto Cook
 2. Press **START** pad. **START**
- The microwave will beep when finished.

USING AUTO DEFROST

Three defrost sequences are preset in the oven. The auto defrost feature provides you with the best defrosting method for frozen foods. The cooking guide will show you which defrost sequence is recommended for the food you are defrosting.

For added convenience, the Auto Defrost includes a built-in beep mechanism that reminds you to check, turn over, separate, or rearrange the food in order to get the best defrost results. Three different defrosting levels are provided:

- 1. MEAT**
- 2. POULTRY**
- 3. FISH**

Available weight is 0.1 to 6.0 lbs.

Suppose you want to defrost 2.0 lbs of meat.

1. Press Defrost pad. Defrost
2. Press **START** pad. **START**
3. Enter cook weight **2 0**
4. Press **START** pad. **START**

(Refer the table on next page)



Manual Operation

KEY PRESS	Category	WEIGHTS YOU CAN SET (tenths of a pound)
Defrost	Meat	0.1 to 6.0
Defrost	Poultry	0.1 to 6.0
Defrost	Fish	0.1 to 6.0

Popcorn

CAUTION

DO NOT leave microwave oven unattended while popping popcorn.

The popcorn feature lets you pop 3 different commercially packaged microwave popcorn sized bags. Use the table below to determine the setting to use:

Key	Food
Popcorn x1	3.3 oz. (default)
Popcorn x2	3.0 oz.
Popcorn x3	1.75 oz.

Example: to pop a 1.75 oz. bag of popcorn automatically:

1. Press **POPCORN** pad 3 times (refer to table above).
Popcorn
2. Press **START** pad **START**

When finished, you will hear a series of beeps.

SETTING VEGGIES

The Veggies quick touch pad lets you cook fresh and frozen vegetables.

Key	Food
Veggies x1	Fresh
Veggies x2	Frozen

Suppose you want to cook frozen veggies.

1. Press **Veggies** pad 2 times (refer to table above).
Veggies
2. Press **START** pad **START**

SETTING MELT/SOFTEN

The oven uses low power to melt and soften items. See the following table.

Key	Food	Amount	Key
Melt / Soften x1	Melt Butter	1 stick	1
		2 sticks	2
Melt / Soften x2	Melt Chocolate	2 oz.	2
		4 oz.	4
		8 oz.	8
Melt / Soften x3	Soften Ice Cream	1 Pint	1
		1.5 Quart	2
Melt / Soften x4	Soften Cream Cheese	3 oz.	3
		8 oz.	8

Suppose you want to melt 8 oz. of Chocolate.

1. Press **Melt/Soften** pad 2 times (refer to table above).
Melt/
Soften
2. Press **START** pad **START**
3. Enter cook weight **8**
4. Press **START** pad **START**

Sensor Operations



Sensor Cook Operating Tips

The **Sensor Cook** categories are designed to detect the increasing humidity released by the food during the cooking process. The microwave oven sensor will automatically adjust the cooking time to the type and amount of food. The food categories that are controlled with the humidity sensor are:

Key	Food
Sensor Cook x1	Frozen Breakfast (8-12oz)
Sensor Cook x2	Ground Meat
Sensor Cook x3	Fish Seafood
Sensor Cook x4	Chicken Breast

For best results, do not use one of the Sensor Cook categories twice in succession on the same food portion. This may result in severely overcooked or burnt food. If the food appears to be undercooked, use one of the Easy Set pads or cook time pads to add more time.

Additional sensor cook suggestions are:

Never start with less than 4 oz. of food.

Use proper containers and covers for best sensor cooking results.

Always use microwave-safe containers.

Never use tight sealing plastic containers.

They will prevent steam from escaping and this will mislead the sensor, usually causing the food to overcook.

Be sure the outside of the cooking containers and the cavity of the microwave oven are dry before placing food in the oven. Excessive moisture turning into steam that does not result from the food cooking can mislead the sensor.

Suppose you want to cook Frozen Breakfast.

1. Press the **Sensor Cook** pad. Sensor Cook
2. Press **START** pad. **START**

Suppose you want to cook Fish Seafood.

1. Press the **Sensor Cook** pad three times. Sensor Cook
2. Press **START** pad. **START**

Sensor Reheat

The reheat feature is designed to detect the increasing humidity released by the food during the cooking process. The microwave oven sensor will automatically adjust the cooking time to the type and amount of food.

Key	Selection	Amount
Sensor Reheat x1	Beverage	1 - 3 cups
Sensor Reheat x2	Dinner Plate	1 - 2 plates
Sensor Reheat x3	Soup - Sauce	1 - 2 cups
Sensor Reheat x4	Casserole	1 - 4 servings

Notes concerning sensor reheat:

- For casseroles, add 2 - 3 tablespoons of liquid, cover with lid or vented plastic wrap. Stir when instructed from display.
- For canned foods, empty contents of can into a casserole dish or serving bowl. Cover dish with lid or vented plastic wrap. Let stand a few minutes before serving.
- For plates of food, arrange food on plate and add any butter or gravies, etc. Cover with loose-fitting lid or vented plastic wrap. After reheating, let stand a few minutes be. ;

Example: suppose you want to reheat 1 cup beverage.

1. Press **Sensor Reheat** pad. **Sensor Reheat**
2. Press **START** pad. **START**
3. Enter 1. **1**
4. Press **START** pad. **START**

Baked Potato

The potato feature cooks 1 - 4 baked potato automatically (starting from room temperature).

1. Press the **Potato** pad. Potato
2. Press **START** pad. **START**



Convenient Features

USER REFERENCE

This section gives instructions for operating each function. Please read this section carefully.

PREFERENCES

The microwave oven has settings that allow you to customize the operation for your convenience. Below is the table showing the various settings. Touch the User Pref key multiple times to scroll to the desired setting function.

Key	Function
User Pref x 1	Volume
User Pref x 2	Weight
User Pref x 3	Language
User Pref x 4	Demo Mode

SETTING AUDIO LOW/MED/HIGH/OFF

Suppose you want to turn on the Volume Off.

1. Press the User Pref pad once.



2. Press **START** pad when display indicates volume level is off.

START

SETTING WEIGHT LBS/KG

Suppose you want to toggle weight between pounds & kilograms.

1. Press the User Pref pad twice.



2. Press **START** pad.

START

SETTING LANGUAGE MODE

Suppose you want to enter Language Mode.

1. Press the User Pref pad three times.



2. Press **START** pad.

START

SETTING DEMO MODE

Suppose you want to enter Demo Mode.

1. Press the User Pref pad four times.



2. Press **START** pad.

START

Care & Cleaning



Cleaning suggestions

For best performance and for safety reasons, keep the oven clean inside and outside. Take special care to keep the inner door panel and oven frame free of food and grease buildup.

Never use rough scouring powder or pads on the microwave. Wipe the microwave oven inside and out with a soft cloth and warm (not hot) mild detergent solution. Then rinse and wipe completely dry.

Wipe splatters immediately with a wet paper towel, especially after cooking greasy foods like chicken or bacon.

Follow these instructions to clean and care for your microwave oven:

Keep the inside (cavity) of the oven clean. Food particles and spilled liquids can stick to the oven walls, causing the oven to work less efficiently.

Wipe up spills immediately. Use a damp, clean cloth and mild detergent. **DO NOT** use harsh detergents or abrasive cleaners.

To help loosen baked-on food particles or liquids, heat 2 cups of water (add the juice of 1 lemon if you desire to keep the oven smelling fresh) in a 4 cup measuring glass at High power for 5 minutes or until boiling. Let stand in oven cavity for 1 to 2 minutes.

Remove the glass turntable tray from the oven when cleaning the oven cavity or tray. To prevent the glass turntable from breaking, handle with care and do not put it in water immediately after cooking. Wash the turntable tray with mild detergent.

Clean the outside surface of the microwave with mild detergent and a clean damp cloth. Dry with a clean soft cloth. To prevent damage to the operating parts of the oven, do not let water seep into any vents or openings.

Wash the oven door window with very mild soap and water. Be sure to use a soft clean cloth to avoid scratching.

If steam accumulates inside or outside the oven door, wipe with a soft cloth. Steam can accumulate when operating the oven in high humidity and in no way indicates microwave leakage.

Never operate the oven without food in the oven cavity; this can damage the magnetron tube or glass tray.



Before You Call

Solutions to Common Problems

Troubleshooting guide

If you have a problem you cannot solve, please do not hesitate to call our service line:

Questions or for Service Call:

1-800-374-4432

Before you call a repair person for your microwave, check the list below for possible easy solutions to some common problems.

Neither the microwave's display or oven operates -

Properly insert the plug into a grounded power outlet.

Remove the plug from the outlet, wait 10 seconds, then plug the microwave in again.

Check the household circuit breaker.

Plug the microwave into a different power outlet.

The oven display works, but the oven will not operate -

Make sure the oven door is closed securely and completely.

Check to see if packing material or other materials are stuck to the door seal.

Check for damage to the oven door. Contact service if dented.

Press the **STOP** pad twice and attempt to re-enter cooking instructions.

Plug the microwave into a different power outlet.

The power goes off before the cook time has elapsed -

If there has been a power interruption, remove the plug from the outlet; wait 10 seconds, then plug the microwave in again. If there was a power outage, the time indicator in the display will show **00:00**.

Reset the clock and any cooking instructions.

Check the household circuit breaker.

Press the **STOP** pad twice and attempt to re-enter cooking instructions.

Plug the microwave into a different power outlet.

Food is cooking too slowly -

Make sure the oven is on a separate 20 amp circuit line. Operating another appliance on the same circuit can cause a voltage drop.

You see sparks or arcing -

Remove any metallic utensils, cookware or metal ties from the oven cavity.

The turntable makes noises or sticks -

Clean the turntable, roller ring and oven cavity bottom.

Make sure the turntable and roller ring are positioned correctly.

Using your microwave causes TV or radio interference -

This is similar to the interference caused by other small appliances, such as hair dryers. Move your microwave further away from other appliances.

Please note: If the oven is set to cook for more than 30 minutes at 100% power level, it will automatically adjust itself to a 80% power level after 30 minutes to avoid overcooking.

Specifications



AC Line Voltage:	Single phase 120V, 60Hz, AC only
Rated Input AC Power Required:	1500W
Rated Output Power*:	1100W
Frequency:	2450 MHz
Outside Dimensions (including handle):	24.4" X 19.8" X 13.5"
Cavity Dimensions:	19.1"X 17.8" X 11.2"
Microwave oven Capacity***:	2.2Cu.Ft.
Cooking Uniformity:	Turntable
Weight:	Approx. (net) 42.90 Lbs, (gross)48.30 Lbs
Oven Light:	1*1.5 W LED

* The International Electrotechnical Commission's standardized method for measuring output wattage. This test method is widely recognized.

** This is the classification of ISM (Industrial, Scientific and Medical) equipment described in the International Standard CISPR11.

*** Internal capacity is calculated by measuring maximum width, depth and height. Actual capacity for holding food is less.

In compliance with standards set by:

- FCC** - Federal Communications Commission Authorized.
- DHHS** - Complies with Department of Health and Human Services (DHHS) rule, CFR, Title 21, Chapter I, Subchapter J.



- This symbol on the nameplate means the product is listed by Underwriters Laboratories, Inc.



- This symbol on the nameplate means the product is listed by Underwriters Laboratories, Inc. for use in USA or Canada.

Compact Appliance Warranty Information



Your appliance is covered by a **one year limited warranty**. For one year from your original date of purchase, Electrolux will pay costs, except as set forth below, associated with replacing any parts of this appliance that prove to be defective in materials or workmanship when such appliance is installed, used, and maintained in accordance with the provided instructions.

Exclusions **This warranty does not cover the following:**

1. Products with original serial numbers that have been removed, altered or cannot be readily determined.
2. Product that has been transferred from its original owner to another party or removed outside the USA or Canada.
3. Rust on the interior or exterior of the unit.
4. Products purchased "as-is" are not covered by this warranty.
5. Food loss due to any refrigerator or freezer failures.
6. Products used in a commercial setting.
7. Service calls which do not involve malfunction or defects in materials or workmanship, or for appliances not in ordinary household use or used other than in accordance with the provided instructions.
8. Service calls to correct the installation of your appliance or to instruct you how to use your appliance.
9. Expenses for making the appliance accessible for servicing, such as removal of trim, cupboards, shelves, etc., which are not a part of the appliance when it is shipped from the factory.
10. Service calls to repair or replace appliance light bulbs, air filters, water filters, other consumables, or knobs, handles, or other cosmetic parts.
11. Surcharges including, but not limited to, any after hour, weekend, or holiday service calls, tolls, ferry trip charges, or mileage expense for service calls to remote areas, including the state of Alaska.
12. Damages to the finish of appliance or home incurred during installation, including but not limited to floors, cabinets, walls, etc.
13. Damages caused by: services performed by unauthorized service companies; use of parts other than genuine Electrolux parts or parts obtained from persons other than authorized service companies; or external causes such as abuse, misuse, inadequate power supply, accidents, fires, or acts of God.
14. Labor costs after ninety (90) days from your original date of purchase incurred for product repair or replacement as provided herein for carry-in appliances.

DISCLAIMER OF IMPLIED WARRANTIES; LIMITATION OF REMEDIES

CUSTOMER'S SOLE AND EXCLUSIVE REMEDY UNDER THIS LIMITED WARRANTY SHALL BE PRODUCT REPAIR OR REPLACEMENT AS PROVIDED HEREIN. CLAIMS BASED ON IMPLIED WARRANTIES, INCLUDING WARRANTIES OF MERCHANTABILITY OR FITNESS FOR A PARTICULAR PURPOSE, ARE LIMITED TO ONE YEAR OR THE SHORTEST PERIOD ALLOWED BY LAW, BUT NOT LESS THAN ONE YEAR. ELECTROLUX SHALL NOT BE LIABLE FOR CONSEQUENTIAL OR INCIDENTAL DAMAGES SUCH AS PROPERTY DAMAGE AND INCIDENTAL EXPENSES RESULTING FROM ANY BREACH OF THIS WRITTEN LIMITED WARRANTY OR ANY IMPLIED WARRANTY. SOME STATES AND PROVINCES DO NOT ALLOW THE EXCLUSION OR LIMITATION OF INCIDENTAL OR CONSEQUENTIAL DAMAGES, OR LIMITATIONS ON THE DURATION OF IMPLIED WARRANTIES, SO THESE LIMITATIONS OR EXCLUSIONS MAY NOT APPLY TO YOU. THIS WRITTEN WARRANTY GIVES YOU SPECIFIC LEGAL RIGHTS. YOU MAY ALSO HAVE OTHER RIGHTS THAT VARY FROM STATE TO STATE.

If You Need Service

Keep your receipt, delivery slip, or some other appropriate payment record to establish the warranty period should service be required. If service is performed, it is in your best interest to obtain and keep all receipts. Service under this warranty must be obtained by contacting Electrolux at the addresses or phone numbers below.

This warranty only applies in the USA and Canada. In the USA, your appliance is warranted by Electrolux Major Appliances North America, a division of Electrolux Home Products, Inc. In Canada, your appliance is warranted by Electrolux Canada Corp. Electrolux authorizes no person to change or add to any obligations under this warranty. Obligations for service and parts under this warranty must be performed by Electrolux or an authorized service company. Product features or specifications as described.

USA
1.800.374.4432
Electrolux Home Products, Inc.,
10200 David Taylor Drive
Charlotte, NC 28262



Canada
1.800.265.8352
Electrolux Canada Corp.
5855 Terry Fox Way
Mississauga, Ontario, Canada
LSV 3E4