

FRIGIDAIRE GALLERY®

CGIF3036T D/F

FREESTANDING RANGE

30" INDUCTION

Smudge-Proof™
Stainless Steel



AVAILABLE COLOURS



PRODUCT DIMENSIONS

Height (Max.)	47"
Width	29-7/8"
Depth (Incl. Handle)	29-1/4"

MORE EASY-TO-USE FEATURES

Auto Sizing™ Pan Detection

Make fluffy pancakes with ease using Auto Sizing™ Pan Detection that automatically senses the size of your pan to only send heat to whatever small, medium, or large pan you are using.

True Temperature Melt & Hold

Get perfectly melted goodness with True Temperature Melt & Hold that delivers low, precise heat for melting delicate ingredients or sauces without scorching or burning for up to one hour.

Smudge-Proof™ Stainless Steel

Resists fingerprints and cleans easily with a stylish, enduring look

Temperature Precision

Sear steaks, crisp sandwiches, melt chocolate, or simmer sauces with the precise temperature control of induction.

Controlled Cooking

Effortlessly create your favourite recipes with Induction's immediate temperature response that adjusts from a powerful boil to a low simmer

Quick Clean

Quickly clean your oven in 2 hours with the self-clean cycle

Safe Surface

The Safe Surface — Induction only heats pans and the food in them: the area around the pans stays cool to the touch.

Energy Efficiency

Since induction only heats your cookware and not your kitchen, less energy is lost throughout the cooking process.

¹9" induction right front burner compared to 3000W Electric Element, 6 qt./10" diameter pot, 1 qt. tepid water.

SIGNATURE FEATURES



Amazingly Fast

Get amazingly fast heat with induction that transfers heat directly to the cookware and not the surface of the cooktop, which means you can boil water 50% faster than an electric cooktop.



Quick Bake Convection

Roast meats faster with Quick Bake Convection that uses a fan to continuously circulate heat around food for more even baking and browning.



Even Heat

Whip up delicious meals with induction that delivers incredibly even heat across the surface of the pan so you get golden results every time.



Easy To Clean

Don't stress over spills with induction's easy-to-clean surface that generates heat only to your pan, not your cooktop, meaning spills can't burn onto the surface.

ELEMENTS	SIZE	WATTS
Right Front	Induction 9"	3,600
Right Rear	Induction 6"	2,500
Left Front	Induction 7"	2,800
Left Rear	Induction 7"	2,800

CGIF3036T D/F FREESTANDING RANGE

30" INDUCTION

FRIGIDAIRE
GALLERY

FEATURES

Oven Control/Timing System	Express-Select® Controls
Surface Type	Black Ceramic Glass
Window	Extra-Large
Exterior Door Finish	Smudge-Proof™ Stainless Steel
Handle Design	Smudge-Proof™ Stainless Steel
Exterior Finish (Side Panels)	Black
Convection System	Quick Bake
Oven Cleaning System	Self Clean
Drawer Functionality	Storage

OVEN CONTROLS

Bake/Broil	Yes/Variable (400 - 550 °F)
Effortless™ Convection Conversion	
Convection Bake/Broil/Roast	
Quick Bake Convection	Yes
Quick Preheat	
Effortless™ Temperature Probe	
Keep Warm	
Add-a-Minute	
Delay Start	
Self Clean	2, 3 Hours
Quick Clean Option	Yes
Delay Clean	Yes
Kitchen Timer/Timed Cook Option	
Auto Oven Shut-Off	
Oven Lock-Out	Yes
Lower Drawer Control	

COOKTOP FEATURES

Right Front Element (Watts)	Induction 9" - 3,600
Right Rear Element (Watts)	Induction 6" - 2,500
Left Front Element (Watts)	Induction 7" - 2,800
Left Rear Element (Watts)	Induction 7" - 2,800
Hot Surface Indicator Light	Yes
Element "On" Indicator Light	Yes

OVEN FEATURES

Capacity (Cu.Ft.)	5.4
Oven Light	1
Hidden Bake Element	Yes
Rack Configuration	2 Standard
Baking System	Even Baking Technology
Broiling System	Vari-Broil™ High/Low
Bake Element/Broil Element (Watts)	3,500/3,900
Drawer Racks	

SPECIFICATIONS

Oven Interior (H x W x D)	21" x 24-3/8" x 19-1/8"
Power Supply Connection Location	Middle Bottom Rear
Voltage Rating	240V/208V/60Hz
Connected Load (kW Rating) @ 240/208 Volts	13.5/10.5
Amps @ 240 Volts	40 Amps
Minimum Circuit Required (Amps)	40
Shipping Weight (Approx.)	215 Lbs.

PRODUCT DIMENSIONS

A - Height (Max.)	47"
B - Width	29-7/8"
C - Depth (Incl. Handle)	29-1/4"
Depth with Door Open 90°	48-5/8"

CABINET CUTOUT DIMENSIONS

Height (Standard)	36"
Width (Min.)	30-1/8"
Depth (Min.)	24"

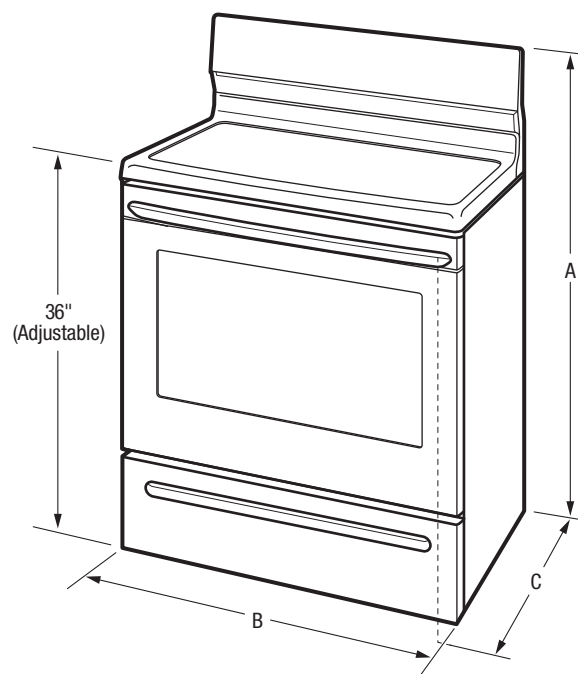

Note: For planning purposes only. Always consult local and national electric, gas and plumbing codes. Refer to Product Installation Guide for detailed installation instructions on the web at frigidaire.ca.
Specifications subject to change. Accessories information available on the web at frigidaire.ca

FRIGIDAIRE

CANADA • 5855 Terry Fox Way • Mississauga, ON L5V 3E4 • 1-800-265-8352 • frigidaire.ca

CGIF3036T 08/17
© 2017 Electrolux Major Appliances, NA

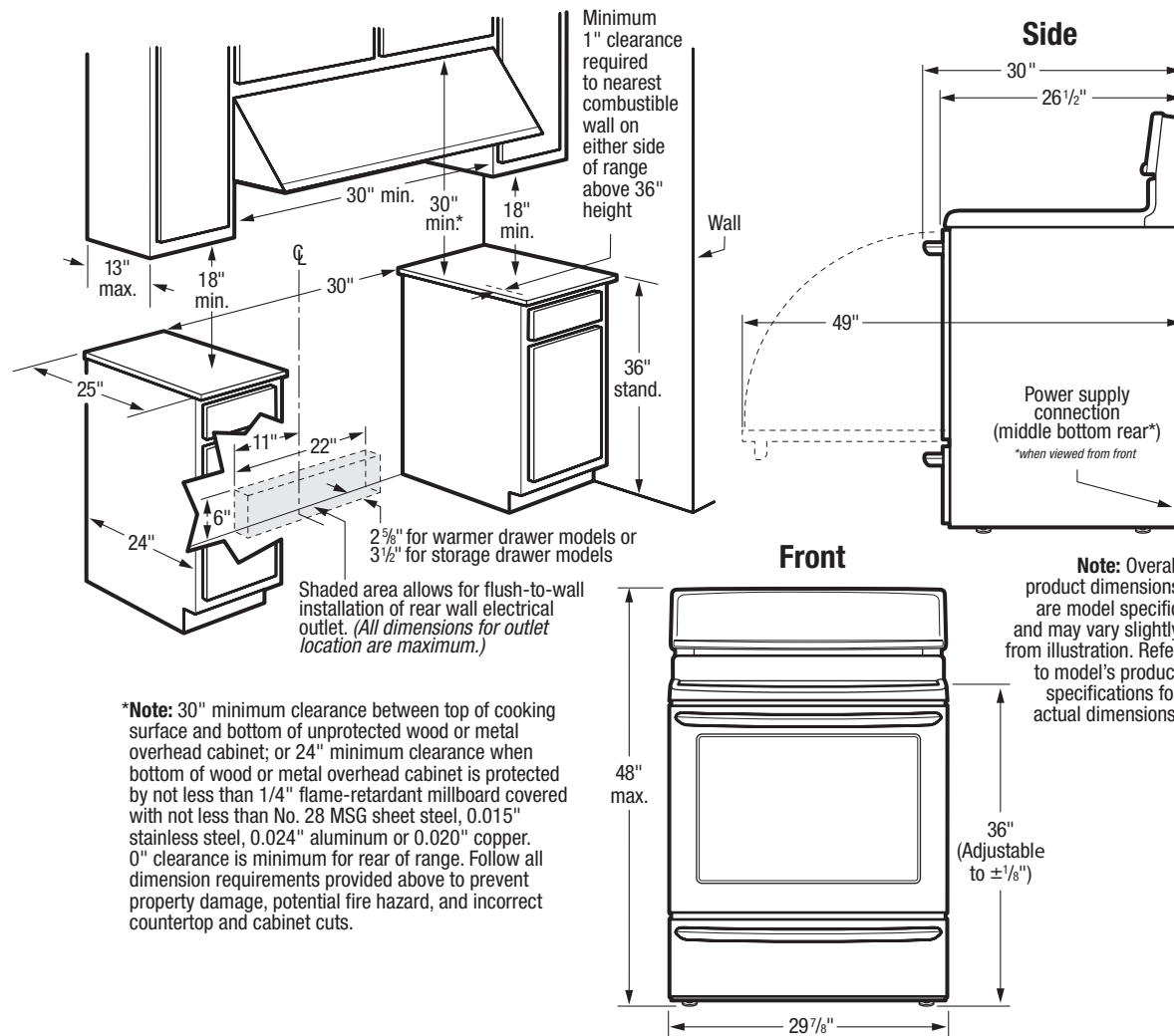

INSTALLATION SPECIFICATIONS

- Product Shipping Weight (approx.) - 215 Lbs.
- Four-conductor (240 V) electrical outlet with correct voltage and polarization required, installed by qualified electrician. Outlet must be properly installed and grounded in accordance with Canadian Electrical Code (CSA Standard C22.1, Part 1 – latest edition) and any local electrical code requirements.
- Connected Load (kW Rating) @ 240/208 Volts = 13.5/10.5kW
- Recommended Circuit Breaker - 40 Amps
- Make sure wall coverings around range can withstand heat generated by range.
- Floor beneath range MUST be solid and level.
- Overhead cabinetry should not exceed a 13" maximum depth.
- Absolute minimum horizontal distance between overhead cabinets installed to either side of appliance must be no less than maximum width of appliance.
- Range can be installed flush to wall with 0" minimum rear clearance.
- Minimum 1" clearance required from edge of rangetop to nearest combustible wall on either side of range above 36" height.
- Allow 30" minimum clearance between top of cooking surface and bottom of unprotected wood or metal overhead cabinet; or 24" minimum clearance when bottom of wood or metal overhead cabinet is protected by not less than 1/4" flame retardant millboard covered with not less than No. 28 MSG sheet steel, 0.015" stainless steel, 0.024" aluminum or 0.020" copper.
- To reduce risk of fire when using overhead cabinetry, install range hood that projects horizontally a recommended minimum of 5" beyond bottom of cabinets.
- Follow all dimension requirements provided to prevent property damage, potential fire hazard, and incorrect countertop and cabinet cuts.

