

Wall Range Hood, 36"

Series 5 | Professional

Stainless Steel



Striking design that pairs well with any appliances in our Professional range. Fast, efficient extraction of steam and odors.

- With four fan speeds, select the perfect extraction rate for your cooking
- With dishwasher-safe stainless steel baffle filters
- Powerful 600CFM maximum airflow

DIMENSIONS

Height	12 "
Width	35 ⁷ / ₈ "
Depth	23 "

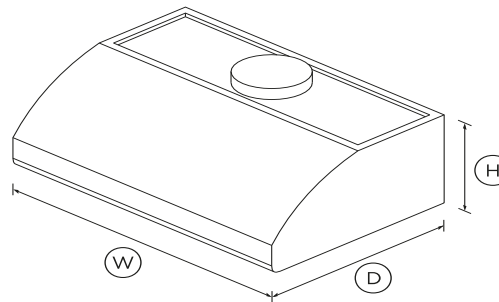

FEATURES & BENEFITS

Design quality

The high quality finish, premium grade stainless steel and robust product design combine to deliver an efficient wall hood. This vent hood can also be installed within cabinetry.

Simple controls

A single on/off button makes the hood easy to use. A slider control lets you precisely adjust the fan speed up or down. Two level halogen lighting effectively illuminates the cooking surface.

Easy cleaning

Filters effectively trap grease particles during extraction. They are easy to remove and dishwasher safe, or can be cleaned by hand in hot soapy water.

Complementary Design

The stainless steel finish is designed to match the rest of the Fisher & Paykel kitchen appliance family.

SPECIFICATIONS

Fan ratings

Maximum blower air flow	600CFM
Maximum sound rating	71dBA

Performance

Extraction type	Surface
Fan speeds	4
Filter type	Dishwasher Safe Slim Stainless

Power requirements

Rated current	15A
Supply frequency	60Hz
Supply voltage	120V

Product dimensions

Depth	23 "
Height	12 "
Width	35 ⁷ / ₈ "

Product information

Control type	Rotary Switch
--------------	---------------

Ventilation featuresLight type **2 level 50-watts halogen**

WarrantyParts and labor **Limited 2 Year Parts & Labor**

SKU **50146**

TEST The product dimensions and specifications in this page apply to the specific product and model. Under our policy of continuous improvement, these dimensions and specifications may change at any time. You should therefore check with Fisher & Paykel's Customer Care Centre to ensure this page correctly describes the model currently available. ? Fisher & Paykel Appliances Ltd 2020

Other product downloads available at fisherpaykel.com[User Guide](#)[Guide D'Utilisation](#)[Installation Guide](#)[Guide D'Installation](#)**A PEACE OF MIND SALE****24 Hours 7 Days a Week Customer Support****T 1.888.936.7872 W www.fisherpaykel.com**