

Integrated Single DishDrawer™ Dishwasher, Tall, Sanitize

Series 11 | Integrated

Panel Ready



Place anywhere in your kitchen at bench height for easy loading and seamless integration. Features a premium stainless steel interior.

- Eight wash cycles from Heavy to Light, including Auto, 60min and Glassware
- Fits full-size dinner plates up to 12 1/4 inches, with flexible racking for large cookware
- With a soft-close drawer, and knock to pause convenience
- Wi-Fi capability and a SmartHQ™ app for remote control and notifications

DIMENSIONS

Height	17 7/8"
Width	23 9/16"
Depth	21 3/4"

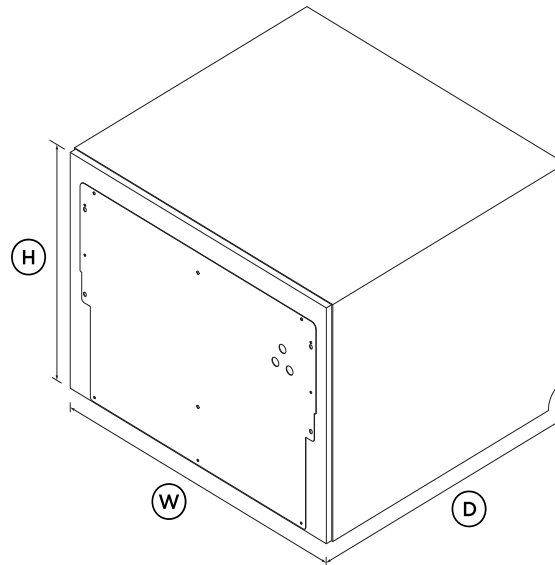

FEATURES & BENEFITS

SEAMLESS INTEGRATION

With the flexibility of ergonomic placement and function, single DishDrawer™ Dishwashers can be distributed throughout the kitchen to support patterns of use. The touch-sensitive control panel is located inside this Integrated model, leaving an uninterrupted exterior that blends seamlessly with surrounding cabinetry.

EASE OF USE

DishDrawer™ Dishwashers are beautiful to use with soft-close drawers, and can be conveniently positioned at bench height for ease of loading and minimal bending. Flexible racking includes height-adjustable cup racks and wine glass supports.

FLEXIBLE WASH OPTIONS

Eight wash programs including Auto, 60min and Glassware, while modifiers such as Sanitize, Dry+ and Quiet provide added wash flexibility. The Quiet wash modifier reduces the noise on some cycles while maintaining performance - perfect for late night washing.

DESIGN QUALITY

Every detail has been carefully crafted using quality materials, from the easy-to-clean stainless steel interior to the spray arm sensor that detects jams for increased wash confidence.

KNOCK TO PAUSE

For ease-of-use, these DishDrawer™ Dishwashers have a knock to pause function. A knock on the front panel will pause the dishwasher, which can be restarted by using the start button.

QUIET PERFORMER

Running at a low decibel rating of 43dBA, these DishDrawer™ Dishwashers do their job without making a fuss. The combination of intelligent technology and simple mechanics means greater reliability and excellent wash performance.

EFFICIENT PERFORMANCE

Our Energy Star rated DishDrawer™ Dishwashers use the energy they need without compromising on wash performance.

SPECIFICATIONS

Accessories

- Cutlery basket
- Knife clip and multipurpose

Accessories (sold separately)

Door panel stainless steel	ADDD24STPX
Handle kit Contemporary	AHS-OBDD-60S
Handle kit Contemporary	AHD5-OBDD-60SX
Handle kit Contemporary	AHD5-OBDD-60SB
Handle kit Contemporary	AHD3-OBDD-60S
Handle kit Professional round	AHP2-DWDD-SX
Handle kit Professional round	AHP3-DWDD-SX

Wi-Fi connectivity •

Parts and labor **Limited 2 years**

Features

- Built-in water softener •
- Fan assisted drying •
- Flood protection •
- Flow through detergent •
- Internal tub material **Stainless Steel**
- Quiet operation •
- SmartDrive™ technology •
- Soft close drawer •

Wash Program Modifiers

- Dry + •
- Quiet •
- Sanitize •
- Wash modifiers **3**

Capacity and loading

Accommodates round plates	12.25"
Adjustable height, foldable	•
Fold down tines	•
Pitch adjustable tines	•
Place settings	7
Wine glass supports with	•

Performance

Noise emissions **43dBA**

Power requirements

Amperage	5A
Rated current	15A
Supply frequency	60Hz
Supply voltage	100 - 120V

Wash Programs

- 60 min •
- Auto •
- Eco •
- Glassware •
- Heavy •
- Light •
- Medium •
- Rinse •
- Wash programs **8**

Consumption

Energy usage	154kWh/year
Water usage (per wash cycle)	1.8 gal

Product dimensions

Depth	21 3/4"
Height	17 7/8"
Width	23 9/16"

Safety and compliance

ADA compliant •

Warranty

Water connection









Inlet water temperature	max 140°F
Supplied hose to suit 3/8"	•
Water pressure	100kPa - 1000kPa
Water supply	3/8" to suit Male Compression

SKU **82166**

The product dimensions and specifications in this page apply to the specific product and model. Under our policy of continuous improvement, these dimensions and

specifications may change at any time. You should therefore check with Fisher & Paykel's Customer Care Centre to ensure this page correctly describes the model currently available. ? Fisher & Paykel Appliances Ltd 2020

Other product downloads available at fisherpaykel.com

-  [Wash Program Data Sheet](#)
-  [Service & Warranty](#)
-  [Wash Program Data Sheet](#)
-  [Energy Label Single DishDrawer™ Dishwasher](#)
-  [User Guide DishDrawer™ Dishwasher](#)
-  [Energy Label Integrated Single DishDrawer™ Dishwasher](#)
-  [Installation Guide DishDrawer™ Dishwasher Venting Kit](#)
-  [Installation Guide Single DishDrawer™ Dishwasher](#)



A PEACE OF MIND SALE

24 Hours 7 Days a Week Customer Support

T 1.888.936.7872 W www.fisherpaykel.com