

USER GUIDE

Wall oven

WODV230 and WOSV230
models

US CA



This user guide is an accompaniment to your 'Quick start guide' which is included with your oven.

For operating instructions, see your 'Quick start guide'. If you no longer have your 'Quick start guide', you can download it from our website, listed on the back cover.

Refer to your 'Quick start guide' for information on:

- Setting the clock
- Controls
- Positioning the shelves
- Conditioning the oven before first use
- Using the timer

CONTENTS

Safety and warnings	2
Cooking guide	6
Oven functions	9
Cooking charts	14
Automatic cooking	20
Using the meat probe	25
User preference settings	28
Sabbath mode	30
Care and cleaning	32
Using the Self Clean function	37
Troubleshooting	40
Alert codes	44
Warranty and service	46

IMPORTANT! **SAVE THESE INSTRUCTIONS**

The models shown in this user guide may not be available in all markets and are subject to change at any time. For current details about model and specification availability in your country, please visit our website listed on the back cover or contact your DCS by Fisher & Paykel dealer.

SAFETY AND WARNINGS

Your oven has been carefully designed to operate safely during normal cooking procedures. Please keep the following safety instructions in mind when you are using it:

WARNING!



Electrical Shock Hazard

Turn the oven off at the wall before replacing the oven lamp.
Failure to follow this advice may result in electrical shock.

WARNING!



Fire Hazard

Follow the instructions on starting a Self Clean cycle carefully. Items made from combustible materials (for example: wood, fabric, plastic) may catch fire if left in the oven during a Self Clean cycle.

Do not place aluminium foil, dishes, trays, water or ice on the oven floor during cooking, as doing so will irreversibly damage the enamel; lining the oven with aluminium foil may even cause fire.

Never use your appliance for warming or heating the room. Persons could be burned or injured or a fire could start.

Storage in or on appliance: flammable materials should not be stored in an oven or near its surface.

Failure to follow this advice may result in death or serious injury.

WARNING!



Hot Surface Hazard

Accessible parts may become hot when in use.

To avoid burns and scalds, keep children away.

Use oven mitts or other protection when handling hot surfaces such as oven shelves or dishes.

Use care when opening the oven door. Let hot air or steam escape before removing or replacing food.

Do not touch heating elements or interior surfaces of the oven. Heating elements may be hot even though they are dark in color. Interior surfaces of an oven become hot enough to cause burns. During and after use, do not touch, or let clothing or other flammable materials contact heating elements or interior surfaces of the oven until they have had sufficient time to cool.

Other surfaces of the appliance may become hot enough to cause burns - among these surfaces are the oven vent, the surface near the oven vent, and the oven door.

Failure to follow this advice may result in serious injury.

WARNING!



Cut Hazard

Take care - some edges are sharp.

Failure to use caution could result in injury or cuts.

IMPORTANT SAFETY INSTRUCTIONS

To reduce the risk of fire, electrical shock, injury to persons or damage when using the oven, follow the important safety instructions listed below:

- **Read all the instructions before using the oven. Use the oven only for its intended purpose as described in these instructions.**
- **Proper installation: be sure your appliance is properly installed and grounded by a qualified technician.**
- **Isolating switch: make sure this oven is connected to a circuit which incorporates an isolating switch providing full disconnection from the power supply.**
- **Household appliances are not intended to be played with by children.**
- **Do not leave children alone. Children should not be left alone or unattended in the area where the appliance is in use. They should never be allowed to sit or stand on any part of the appliance.**
- **Children of less than 8 years old must be kept away from the appliance unless continuously supervised. This appliance can be used by children aged from 8 years and above, and persons with reduced physical, sensory or mental capabilities or lack of experience and knowledge, if they have been given supervision or instruction concerning the use of the appliance in a safe way and they understand the hazards involved. Cleaning and user maintenance shall not be done by children without supervision.**
- **Do not place heavy objects on the oven door.**
- **Wear proper apparel. Do not wear loose fitting or hanging garments when using the appliance. They could ignite or melt if they touch an element or hot surface and you could be burned.**
- **User servicing: do not repair or replace any part of the appliance unless specifically recommended in the manual. All other servicing should be referred to a qualified technician.**
- **Do not use water on grease fires. Smother the fire or flame or use a dry chemical or foam type extinguisher.**

IMPORTANT SAFETY INSTRUCTIONS

- Use only dry oven mitts or potholders. Moist or damp potholders on hot surfaces could result in burns from steam. Do not let potholders touch hot areas or heating elements. Do not use a towel or a bulky cloth for a potholder. It could catch fire.
- Do not heat unopened food containers. They can build up pressure that may cause the container to burst and result in injury.
- Safe food handling: leave food in the oven for as short a time as possible before and after cooking. This is to avoid contamination by organisms which may cause food poisoning. Take particular care during warm weather.
- Always keep oven vents unobstructed.
- Do not operate your appliance by means of an external timer or separate remote-control system.
- Caution: Hot air can blow from the vent at the base of the oven as part of the oven's cooling system.
- Placement of oven shelves: always position shelves in the desired location while the oven is cool (before preheating). If a shelf must be removed while the oven is hot, do not let the oven mitts or potholder contact hot heating elements in the oven or the base of the oven.
- Do not clean the oven seal or use any oven-cleaning products on it. It is essential for a good seal, which ensures that the oven operates efficiently. Care should be taken not to rub, damage or move it.
- Do not use oven cleaners, harsh/abrasive cleaning agents, waxes, or polishes. No commercial oven cleaner, oven liner, or protective coating of any kind should be used in or around any part of the oven. Do not use harsh/abrasive cleaners, scourers or sharp metal scrapers to clean the oven door glass since they scratch the surface, which may result in the glass shattering.
- Clean only the parts listed in this manual.
- Do not use a steam cleaner to clean any part of the oven.
- Double oven models only:
- You can only Self Clean one oven at a time, and whilst in a Self Clean cycle, the other oven cannot be used.

IMPORTANT SAFETY INSTRUCTIONS

- **Before starting a Self Clean cycle, remove oven shelves, side racks, and all other cookware/utensils, and wipe up large food spills or grease deposits.**
- **Before starting a Self Clean cycle, make sure you move any pet birds to another, closed and well-ventilated room. Some pet birds are extremely sensitive to the fumes given off during a Self Clean cycle and may die if left in the same room as the oven during such a cycle.**
- **During a Self Clean cycle, the oven reaches higher temperatures than it does for cooking. Under such conditions, the surfaces may get hotter than usual and children should be kept away.**
- **Do not store things children might want above the oven. Children could be burned or injured while climbing on the oven to retrieve items.**
- **Do not install or operate the appliance if it is damaged or not working properly. If you receive a damaged product, contact your dealer or installer immediately.**
- **Use only bakeware approved for oven use. Follow the bakeware manufacturer's instructions.**
- **The California Safe Drinking Water and Toxic Enforcement Act requires businesses to warn customers of potential exposure to substances which are known by the State of California to cause cancer or reproductive harm. Small amounts of harmful chemicals are given off in the oven's self-cleaning cycle from insulation and food decomposition. Significant exposure to these substances can cause cancer and reproductive harm. Venting with a hood or open window, and wiping out excess food spills prior to self-cleaning the oven reduces exposure.**

COOKING GUIDE

Congratulations on your new purchase. Your DCS by Fisher & Paykel oven has a number of features to make cooking a great experience for you:

- a wide choice of oven functions
- a convenient Self-Clean function – see ‘Using the Self Clean function’
- intuitive controls and displays
- illuminated halos around the knobs for visual feedback

Before you start

- Make sure the installer has completed the ‘Final checklist’ in the Installation instructions.
- Read this guide, taking special note of the ‘Safety and warnings’ section.
- Remove all packaging and dispose of it responsibly. Make sure all cable ties used to secure the shelves during shipping have been removed. Recycle items that you can.
- Check that you have all the accessories listed in the separate ‘Quick start guide’.
- Make sure you follow the instructions under ‘Setting the clock and first use’ in the separate ‘Quick start guide’ before using your oven.

General guidelines

This oven has been designed to utilise its four elements and rear fan in differing combinations to provide you with enhanced performance and a wide range of functions, allowing you to cook all types of food to perfection.

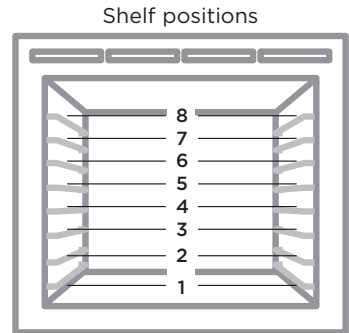
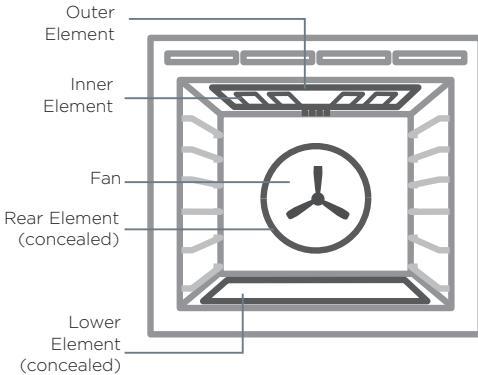

Setting an oven function

Turn the function knob to the right to select a function. Turning the knob to the following positions will select the corresponding function, which appears in the display:

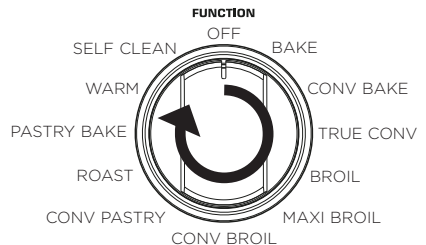

COOKING GUIDE

BAKING

- For best results when baking, always pre heat your oven. The broil element may come on for a short time while the oven is heating up. The temperature knob halo will turn from white to orange when the preset temperature is reached.
- Do not open the door until at least 3/4 of the way through cooking.
- Make sure cake pans do not touch each other or the sides of the oven.
- When baking double the recipe (especially cookies) you may need to increase the time.
- Your cookware will influence baking times. Dark pans absorb the heat more quickly than reflective pans; glass cookware may require a lower temperature.
- Multi-shelf baking may also require a slight increase in cooking time.
- Always leave a space between shelves when multi-shelf cooking to allow the air to circulate.

Shelf Position Guide

Place your baking on a shelf that will have the top of your pan near the center of the oven cavity.

ROASTING

- Your oven has a dedicated ROAST function. This is designed to brown the outside of the meat but still keep the inside moist and juicy.
- Use the meat probe for perfect results. See 'Using the Meat Probe'.
- Boneless, rolled or stuffed roasts take longer than roasts containing bones.
- Poultry should be well cooked with the juices running clear and an internal temperature of 165°F / 75°C.
- If using a roasting bag, do not use the ROAST function. The initial searing stage is too hot for roasting bags. Use CONV BAKE or TRUE CONV and follow the manufacturer's instructions.
- When using the ROAST function, do not cover your roast, as this will stop the searing process browning the outside of the meat. If you prefer to roast in a covered pan, use the CONV BAKE function instead and increase the temperature by 70°F / 20°C.
- Cook larger cuts of meat at a lower temperature for a longer time. The meat will cook more evenly.
- Always roast meat fat side up. That way, basting may not be required.
- Always rest the meat for at least 10 minutes after roasting to allow the juices to settle. Remember the meat will continue to cook for a few minutes after removing it from the oven.

Shelf Position Guide

Place the meat on a shelf so that the meat is in the center of the oven or lower.

COOKING GUIDE

BROILING

- This is a healthier alternative to frying.
- Always broil with the oven door completely shut.
- If you use glass or ceramic pans, be sure they can withstand the high temperatures of broiling.
- To avoid piercing the meat and letting juices escape, use tongs or a spatula to turn the meat halfway through cooking.
- Brush meat with a little oil to help keep the meat moist during cooking. Alternatively marinate the meat before broiling (but be aware that some marinades may burn easily).
- Where possible broil cuts of meat of a similar thickness at the same time. This will ensure even cooking.
- Always keep a close watch on your food while broiling to avoid charring or burning.
- The three-piece broil/roast system provided with your oven (consisting of the pan, grid and rack) has been designed to reduce splatter and smoke, and is therefore ideal for broiling and roasting. We suggest you place meat on the broil/roast rack (on top of the pan and grid) to allow hot air to circulate around it. This gives more even browning and a result similar to a rotisserie.
- On occasions, you may want to use only two pieces of the system. For example, when roasting a large turkey, use only the pan and grid for greater stability.

Shelf Position Guide

- For thinner cuts of meat, toasting or browning foods, use a higher shelf position.
- Thicker cuts of meats should be broiled on lower shelves or at a lower broil setting to ensure even cooking.

REHEATING

- Use BAKE or CONV BAKE to reheat food.
- BAKE function is particularly good for reheating pastry based items, as the base heat will help re-crisp the pastry case.
- Always reheat food to piping hot. This reduces the risk of contamination by harmful bacteria.
- Once hot, use the WARM function to keep the food warm.
- Never reheat food more than once.

If you wish to finish cooking using the residual heat in the oven

Leave the oven on and reduce the heat to the lowest temperature. Leaving the oven on will decrease the risk of condensation forming (condensation may cause damage to the oven cavity and surrounding cabinetry).

OVEN FUNCTIONS

IMPORTANT!

- Use all the functions with the oven door closed.

BAKE

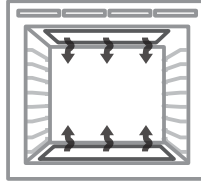

upper outer and lower elements

- Heat comes from both the upper and lower elements. The fan is not used in this function.
- Ideal for cakes and foods that require baking for a long time or at low temperatures.
- This function is not suitable for multi-shelf cooking.

Ideal for moist foods that take a longer time to cook eg rich fruit cake.

CONV BAKE

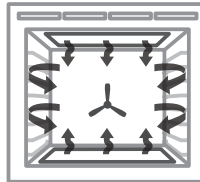

fan plus upper outer and lower elements

- The oven fan circulates hot air from the top outer and the lower elements and distributes it around the oven cavity.
- Food cooked tends to brown more quickly than foods cooked on the traditional Bake function.
- You may need to decrease the time from that recommended in traditional recipes.
- Use CONV BAKE at a low temperature: 120°F / 50°C for drying fruit, vegetables and herbs.

Ideal for single shelf baking that takes less than an hour to cook - foods such as muffins, English scones and cupcakes or things like enchiladas.

OVEN FUNCTIONS

TRUE CONV

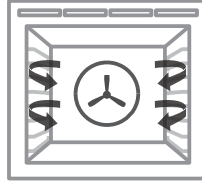

fan and rear element

- By using the central rear heating element and fan, hot air is blown into the cavity, providing a consistent temperature at all levels, making it perfect for multi-shelf cooking.
- Trays of cookies cooked on different shelves are crisp on the outside and chewy in the middle.
- Meat and poultry are deliciously browned and sizzling while remaining juicy and tender.
- Casseroles are cooked to perfection and reheating is quick and efficient.
- When multi-shelf cooking it is important to leave a gap between trays (eg use shelves 3 & 5) to allow the air to move freely. This enables the browning of foods on the lower tray.
- If converting a recipe from BAKE to TRUE CONV, we recommend that you decrease the bake time or decrease the temperature by approximately 70°F / 20°C.
- For items with longer bake times (eg over an hour) it may be necessary to decrease both time and temperature.

Ideal for multi-shelf cooking, cookies, English scones, muffins and cupcakes.

BROIL

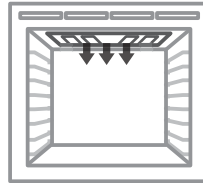

upper inner element

- Intense radiant heat is delivered from the inner top element.
- Preheating is not essential although some people prefer to allow the element to heat for a few minutes before they place food under the broil element.
- The most suitable function for 'finishing off' many meals, for example browning the top of potato gratin and frittata.

Ideal for toasting bread or for top browning to 'finish off dishes'.

OVEN FUNCTIONS

MAXI BROIL

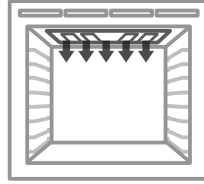

upper inner and outer elements

- Intense radiant heat is delivered from both top elements.
- Preheating is not essential although some people prefer to allow the element to heat for a few minutes before they place food under the broil element.
- The most suitable function for 'finishing off' many meals, for example browning the top of potato gratin and frittata.

Ideal for toasting bread or for top browning to 'finish off dishes'.

CONV BROIL

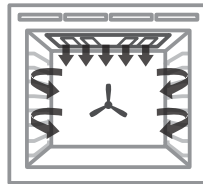

fan plus upper inner and outer elements

- This function uses the intense heat from the elements for top browning and the fan to ensure even cooking of foods.
- Meat, poultry and vegetables cook beautifully; food is crisp and brown on the outside while the inside remains moist and tender.

Ideal for whole chicken, tenderloin of beef or broiling your favorite chicken, fish or steak.

OVEN FUNCTIONS

CONV PASTRY

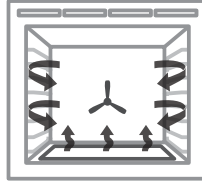

fan plus lower element

- The fan circulates heat from the lower element throughout the oven.
- Excellent for cooking pizza as it crisps the base beautifully without overcooking the topping.

Ideal for foods such as sweet and savory pastry foods and delicate foods that require some top browning eg frittata, quiche.

ROAST

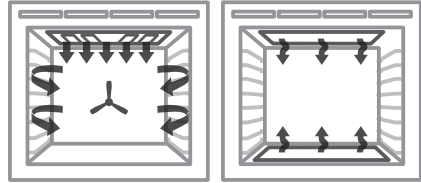

fan plus upper and lower elements

- A two-step program. An initial 20 minute searing stage crisps and browns the roast and caramelises the outside of the meat, then the temperature drops to the level you have preset for the remainder of the cooking period, producing a tender and juicy roast that is full of flavour.
- Oven does not require preheating.
- If desired, use the broil rack, grid or place vegetables under the roast to allow the juices to drain away from your meat. This will allow the hot air to circulate under the meat as well.

Ideal for Roasting meat, chicken and vegetables.

PASTRY BAKE

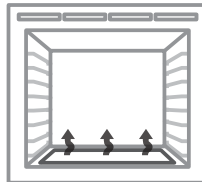

lower element only

- Heat comes from the lower element only, the fan is not used.
- This is the traditional baking function, suitable for recipes that were developed in older ovens.
- Bake on only one shelf at a time.
- The oven will be hotter at the top.

Ideal for foods that require delicate baking and have a pastry base, like custard tarts, pies, quiches and cheesecake or anything that does not require direct heat and browning on the top.

OVEN FUNCTIONS

WARM

this is not a cooking function

- Provides a constant low heat of less than 195°F / 90°C.
- Use to keep cooked food hot, or to warm plates and serving dishes. To reheat food from cold, use another oven function to heat the food piping hot and only then change to Warm, as this function alone will not bring cold food up to a high enough temperature to kill any harmful bacteria.
- Use the WARM function to prove bread. See 'Tips for proving bread'.

SELF CLEAN

this is not a cooking function

- The Self Clean cycle takes care of the mess and grime that is traditionally associated with oven cleaning.
- There are two Self-Clean cycles available:
 - Self clean (which takes 5 hours) for normal cleaning and
 - Light self-clean (which takes 4 hours) for lightly soiled ovens.
- See 'Using the Self Clean function' in the User guide for details.

Tips for dehydrating fruit

- To obtain high quality dried fruit, select only unblemished, ripe fruit.
- Wash fruit thoroughly and pat dry. Peel if desired. Fruit that is not peeled will take longer to dry. Remove pits, stems or seeds if necessary. Place fruit on a baking tray on a shelf in the oven.
- We recommend using TRUE CONV or CONV BAKE at 120°F / 50°C.

Tips for proofing bread

- Your oven provides an ideal sealed environment for proofing bread.
 - ① Select the WARM function.
 - ② Adjust the temperature down until the display shows 'Lo'.
 - ③ Place dough in a lightly oiled bowl and cover with plastic wrap and/or a clean damp cloth.
 - ④ Place the bowl into the warmed oven on shelf position 1.

Note: some recipes recommend putting water or ice in the oven with the bread dough during baking. The additional moisture improves the bread crust. You must place the water or ice in a heat resistant dish and on an oven shelf in positions 1 or 2. Do not put it directly onto the oven floor. Placing water, ice or any dish or tray directly on the oven floor will irreversibly damage the enamel.

COOKING CHARTS

- Shelf positions are counted from the base up (1 is the lowest, 8 is the highest).
Position shelves before you turn the oven on.
- For best results preheat the oven to the required temperature.
- The broil element may come on while the oven is heating up.
- The halo on the temperature knob will change from white to orange when the oven has reached the selected temperature. The halo may change between white and orange as the oven maintains its set temperature.

BAKING

FOOD	SHELVES	
Biscuits	Plain	Single Multi
	Chewy Choc Chip	Single Multi
	Sugar Cookies	Single Multi
Cakes	Pound Cake	Single
	Chocolate Brownie (8"x8"/20x20cm pan)	Single
	Angel Food Cake (10"x4"/25x10cm tube pan)	Single
	Rich Fruit Cake	Single
	Sponge (single large)	Single
	Sponge (2x20cm)	Single
Muffins / Cupcakes	Cupcakes	Single Multi
	Muffins	Single Multi
Scones	English Scones	Multi
Meringues	Meringues	Single
Bread/Bread rolls	Sandwich Loaf (9"x5"/23x13cm Loaf Pan)	Multi
	Wholewheat Loaf (9"x5"/23x13cm Loaf Pan)	Single
	Soft Dinner Rolls	Single
	Dough Proof	Single
Pastry	Pastry Shell (baked blind)	Single
Pies	Fruit Pie (2 crust)	Single
	Baked Cheesecake (in water bath)	Single
	Pumpkin Pie (blind bake, add filling)	Single
	English Custard Tart (blind bake, then add filling)	Single
Dessert	Crème Brulee (in water bath)	Single
	Crème Caramel (in water bath)	Single

COOKING CHARTS

The information in these charts are guidelines only. Refer to your recipe or the packaging and be prepared to adjust the cooking times and settings accordingly.

RECOMMENDED FUNCTION	SHELF POSITIONS	TEMP (°F)	TEMP (°C)	TIME (MINS)
Conv Bake	4	400 - 425	210 - 220	8 - 10
True Conv	2 & 5	425 - 450	215 - 230	10 - 12
Conv Bake	4	355 - 375	180 - 190	10 - 15
True Conv	2 & 5	325 - 340	160 - 170	10 - 15
Conv Bake	4	350 - 375	175 - 190	7 - 15
True Conv	2 & 5	325 - 350	160 - 175	7 - 15
Bake	4	325	160	70 - 80
Bake	4	350	175	20 - 25
Bake	4	325 - 350	160 - 175	50 - 60
Bake	4	275 - 300	135 - 150	3 - 6 hrs
Bake	4	350	175	30 - 40
Bake	4	350	175	15 - 25
Bake	4	365	185	13 - 18
True Conv	2 & 5	345	170	13 - 18
Conv Bake	4	345	170	23 - 30
True Conv	2 & 5	345	170	23 - 30
True Conv	4	425 - 450	215 - 230	10 - 12
Conv Bake	4	250 - 270	120 - 130	60 - 70
True Conv	4	350	175	40 - 50
Bake	4	375	190	35 - 45
Bake	4	375	190	15 - 18
Bake	1	LO	LO	30
Bake	4	350	175	15
Bake	4	400 - 350	200 - 175	20 - 25
Warm	4	325	160	50 - 60
Conv Pastry	4	350 - 375	175 - 190	15 - 30
Conv Bake	4	350 - 300	175 - 150	15 - 30
Pastry Bake	4	275	135	35 - 45
Pastry Bake	4	350	175	35 - 45

COOKING CHARTS

SAVOURY

FOOD	SHELVES
Cornbread	Single
Vegetables	Single
Lasagne	Single
Casserole	Single
Pizza	Single
Quiche (blind bake, then add filling)	Single
Potatoes (whole, baked)	Single
Frittata (shallow)	Single
Oven Meals	Single

ROASTING

FOOD	SHELVES *	RECOMMENDED FUNCTION	
Beef (Boneless)	Rare	Roast	
	Medium	Roast	
	Well Done	Roast	
Prime Rib Roast	Rare	Roast	
	Medium	Roast	
	Well Done	Roast	
Lamb Rack	Medium Rare	Bake	
Lamb leg (Bone in)	Medium	Roast	
	Well Done	Roast	
Lamb leg (Boneless)	Medium	Roast	
	Well Done	Roast	
Veal	Medium	Roast	
	Well Done	Roast	
Chicken	Whole Unstuffed	Conv Broil	
	Whole Stuffed	Bake	
	Whole Butterflied	Conv Broil	
Turkey (Whole)	Stuffed	Bake	
	Unstuffed	Bake	
Pork (Boneless)	Medium	Roast	
	Well Done	Roast	
Pork Crackling	Crisp (watch closely)	Conv Broil	
Venison	Brown in a pan first.	Rare	Conv Broil
		Medium	Conv Broil

* If multiple shelves are required (eg roasting vegetables at the same time), use True Conv and shelf positions 1 & 4.

COOKING CHARTS

RECOMMENDED FUNCTION	SHELF POSITIONS	TEMP (°F)	TEMP (°C)	TIME (MINS)
Conv Bake	4	400-425	210-215	20-25
Conv Bake	4	350-375	175-190	30-50
Conv Bake	4	350-375	175-190	35-40
Bake	4	300-350	150-175	1-2 hours
Conv Pastry	2	425	220	10-15
Conv Pastry	4	350	175	15-30
Bake	4	390	200	50-60
Conv Pastry	3	340-360	170-180	15-20
True Conv	4	340-375	170-190	30-40

SHELF POSITIONS	TEMP (°F)	TEMP (°C)	TIME (MINS)	MEAT PROBE (°F) **	MEAT PROBE (°C) **
3	320-340	160-170	18-32 /450g	130-138	54-59
3	320-340	160-170	25-40 /450g	140-165	60-74
3	320-340	160-170	30-55 /450g	165-174	74-79
3	320-340	160-170	15-30 /450g	130-138	54-59
3	320-340	160-170	20-35 /450g	140-165	60-74
3	320-340	160-170	25-40 /450g	165-174	74-79
3	390	200	20	122	50
3	320-340	160-170	18-28 /450g	149-158	65-70
3	320-340	160-170	20-33 /450g	165-174	74-79
3	320-340	160-170	20-35 /450g	149-158	65-70
3	320-340	160-170	25-45 /450g	170-174	77-79
3	320-340	160-170	20-40 /450g	160	71
3	320-340	160-170	25-45 /450g	170	76
3	350	175	15-20 /450g	165	75
3	350	175	17-22 /450g	165	75
4	350	175	40-50	165	75
2 or 3	320-340	160-170	17-22 /450g	165	75
2 or 3	300-330	150-165	15-20 /450g	165	75
3	340-350	170-175	25-40 /450g	145-154	63-68
3	340-350	170-175	30-45 /450g	165-174	74-79
4	430	220	5 to 10	na	na
4	435	225	7 /2.5cm meat thickness	120-129	49-54
4	435	225	9 /2.5cm meat thickness	131-140	55-60

** The internal temperature will rise more on standing.

COOKING CHARTS

BROILING

FOOD		SHELVES	
Beef	Steak	Rare	Single
		Medium	Single
	Hamburger (ground - patties)		Single
	Meatballs (ground)		Single
Lamb Chops		Medium	Single
		Well done	Single
Pork	Chops (well done)		Single
	Ham steak		Single
	Bacon		Single
Chicken	Boneless pieces		Single
	Bone In Pieces		Single
Sausages	Sausages		Single
Fish	Fillets		Single
	Whole		Single
Vegetables	Sliced		Single

COOKING CHARTS

RECOMMENDED FUNCTION	SHELF POSITIONS	TEMP (°F)	TEMP (°C)	TIME (MINS)
Broil	6	HI	HI	8-10
Broil	6	HI	HI	10-15
Broil	6	HI	HI	12-15
Broil	6	HI	HI	12-15
Broil	6	HI	HI	15-20
Broil	6	HI	HI	20-25
Broil	6	HI	HI	15-20
Broil	6	HI	HI	15-20
Broil	6	HI	HI	4-7
Conv Broil	4	350	175	30-50
Conv Broil	4	350	175	40-50
Broil	6	HI	HI	10-15
Conv Broil	5	390-430	200-220	8-12
Conv Broil	5	390-430	200-220	15-20
Broil	6	HI	HI	8-12

AUTOMATIC COOKING

Delayed Cook

- You can set the oven to automatically turn on later, cook for a preset time (cook length) and then automatically turn off at a preset time. See the example and instructions below.
- **Double oven models only:** you can set one or both ovens to cook automatically. If one oven is set for automatic cooking you can still use the other normally.
- Note: before setting a delayed cook, make sure that your oven is displaying the correct time of day.

IMPORTANT!

Safe food handling: leave food in the oven for as short a time as possible before and after cooking or defrosting. This is to avoid contamination by organisms which may cause food poisoning. Take particular care during warmer weather.

Example: It is 2:25 p.m. You want your food to cook for 2 hours, and you would like it to be ready by 6:30 p.m.

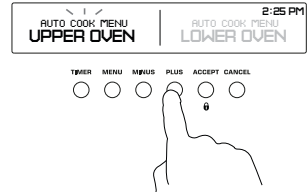
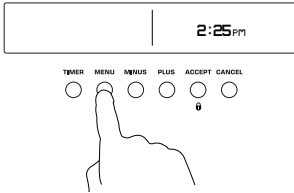

- ① Press MENU once to enter the Automatic Cooking menu.

Double ovens only:

- The display of the oven that is active will flash.
Select which cavity you wish to set delayed cook for:
- ① Ⓐ Press PLUS or MINUS to scroll between ovens.
 - ① Ⓑ Press ACCEPT to confirm.

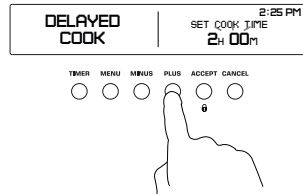
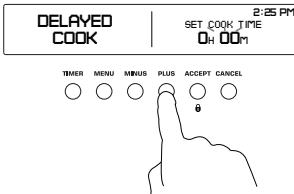

- ② Press PLUS to edit **DELAYED COOK**.
 - Below SET COOK TIME, 0h 00m will flash.

- ③ Press PLUS and MINUS to set the cooking time. Make sure you allow for preheat time in your calculation.
- ④ Press ACCEPT to confirm.

AUTOMATIC COOKING

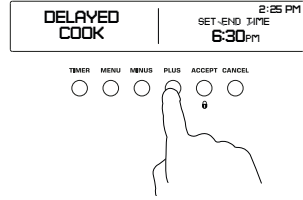
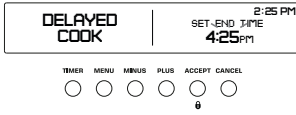

- ⑤ SET END TIME will appear in the right hand display.
- The end time will flash.

- ⑥ Press PLUS and MINUS to set the time you would like your food to be ready by.
- ⑦ Press ACCEPT to confirm.

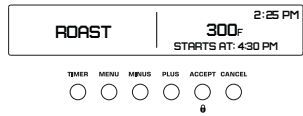
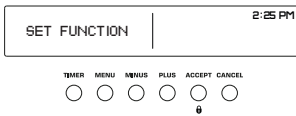

If you have not already set a function and temperature:

- SET FUNCTION will appear in the display.
 - The function knob halo will blink orange.
- ⑧ Select a function and adjust the temperature using the function and temperature knobs.

- ⑨ Your oven is now set for delayed cook
 - The function and temperature will show in the display.
 - While the oven is waiting to start cooking, STARTS AT and the time that the oven is set to start cooking will show in the display.
 - When the oven has begun cooking, ENDS IN and the cooking time left will show in the display.

AUTOMATIC COOKING

If you have started cooking manually and want to set the oven to turn off automatically

You can set your oven either to cook for a set length of time:

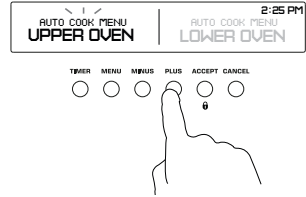
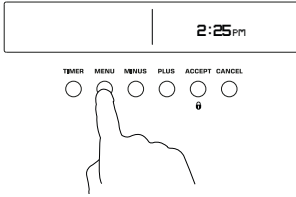

- 1 Press MENU once to enter the Automatic Cooking menu.

Double ovens only:

- The display of the oven that is active will flash.
Select which cavity you wish to set delayed cook for:
- 1(A) Press PLUS or MINUS to scroll between ovens.
 - 1(B) Press ACCEPT to confirm.

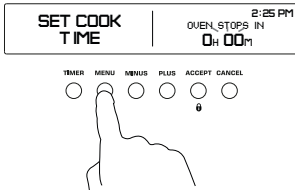

- 2 Press MENU to scroll through the Automatic Cooking settings to **SET COOK TIME**.
- 3 Press PLUS to accept.
 - OVEN STOPS IN will appear in the display.
 - 0h 00m will flash.

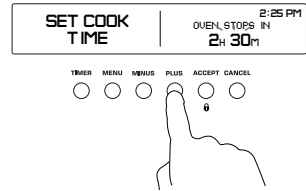

- 4 Press PLUS and MINUS to set the time you would like your food to cook for.
- 5 Press ACCEPT to confirm.

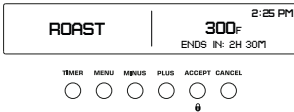

- 6 The oven is now set to automatically turn off after a set length of time.
 - The function and temperature will show in the display.
 - ENDS IN and the time that the oven is set to cook for will show in the display.

AUTOMATIC COOKING

If you have started cooking manually and want to set the oven to turn off automatically

Alternatively, you can set your oven to turn off at a set time of day:

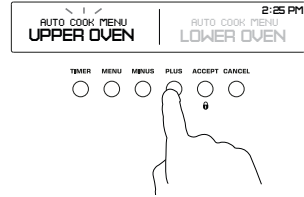
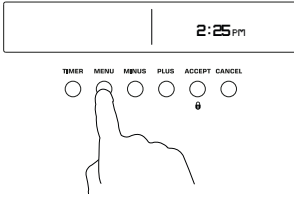

- 1 Press MENU once to enter the Automatic Cooking menu.

Double ovens only:

- The display of the oven that is active will flash.
Select which cavity you wish to set delayed cook for:
- 1(A) Press PLUS or MINUS to scroll between ovens.
 - 1(B) Press ACCEPT to confirm.

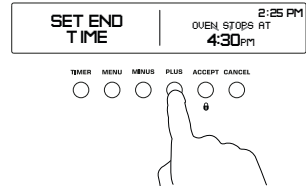
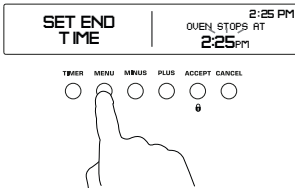

- 2 Press MENU to scroll through the Automatic Cooking settings to **SET END TIME**.
- 3 Press PLUS to accept.
 - OVEN STOPS AT will appear in the display.
 - The current time will flash.

- 4 Press PLUS and MINUS to set the time of day you would like your oven to turn off.
- 5 Press ACCEPT to confirm.

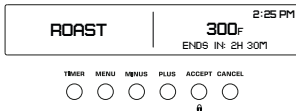

- 6 The oven is now set to automatically turn off after a set length of time.
 - The function and temperature will show in the display.
 - ENDS IN and the time that the oven is set to cook for will show in the display.

AUTOMATIC COOKING

Double oven models only:

To set automatic cooking for the second oven, follow the steps above, selecting the second oven at step 2.

When automatic cooking is set

- The oven and the lights will stay off, the halos will be unlit, but your oven is now set for automatic cooking. It will automatically turn on at the required time.
- Note: you can modify the function and temperature while the oven is waiting to start cooking.

While the oven is heating up

IMPORTANT!

- **During automatic cooking the broil element will come on while the oven is heating up. Food placed into a cold oven could be prone to burning as the oven heats up.**
- **Large items and foods with a high fat or sugar content are especially prone to burning. Take particular care with foods such as macaroni cheese, large poultry, and enchiladas.**
- **Ideal foods for automatic cooking include stews, casseroles, braised meat and potato top pie.**
- **Position food on a lower shelf to prevent burning.**
- **Where possible cook food in a pan with a lid, or cover food with foil.**

To change the cook length or end time

- Follow the steps previously to enter the Automatic Cooking menu and adjust as desired.

To exit the Automatic Cooking menu

- Press and hold CANCEL to clear the selection at any point while adjusting Automatic Cooking and exit the menu.

To cancel automatic cooking

- When automatic cooking has been set, turn the function knob to Off at any point to cancel.

When the stop time is reached

The temperature will turn off and a long tone will sound.
Turn the function knob to the off position.

USING THE MEAT PROBE

Using the meat probe

Use the meat probe to accurately judge when your meat is perfectly cooked, and to automatically turn off your oven when the desired temperature is reached.

- You can use the meat probe with any function.
- **Double ovens only:** you can use the meat probe with either oven. If you are using the meat probe in one oven, you can still use the other oven normally.

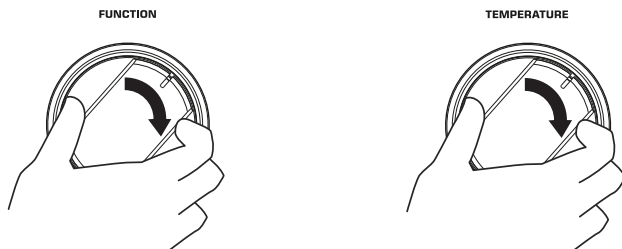

- ① Select the oven function and temperature. Preheat the oven if appropriate. Remember ROAST and CONV BROIL do not require preheating.

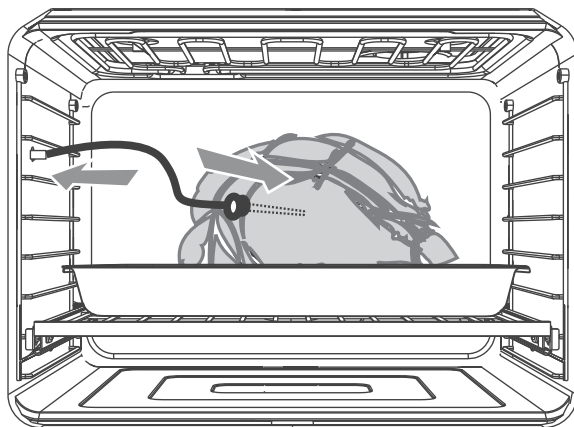

- ② Insert the metal probe horizontally into the center of the thickest part of the fully defrosted meat. The thicker the meat, the longer it will take to cook, so it is important that the probe is measuring the temperature of the meat at its thickest point. Make sure the probe does not touch bone, fat or gristle, as these will heat up more quickly than the lean meat.
- ③ Place the meat in the broil pan (or other suitable uncovered dish).
- ④ When the oven has preheated (if required) to the set temperature, place the dish in the oven and insert the plug end of the meat probe into the probe socket, using an oven mitt if the oven is hot. The probe socket is on the left hand side of the oven, between shelf positions 4 and 5. Make sure the probe is pushed completely into the socket, then close the oven door.

USING THE MEAT PROBE

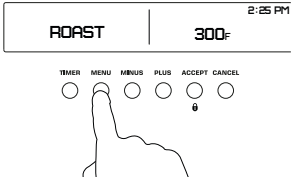

- ⑤ Press MENU once to enter the Automatic Cooking menu.

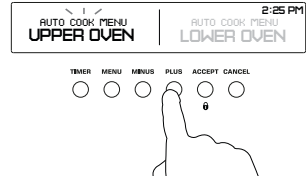

Double ovens only:

- The display of the oven that is active will flash.
- Select which cavity you wish to set delayed cook for:
- ⑥Ⓐ Press PLUS or MINUS to scroll between ovens.
- ⑥Ⓑ Press ACCEPT to confirm.

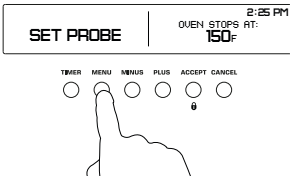

- ⑦ Press MENU again to scroll through the Automatic Cooking settings to **SET PROBE**.

- OVEN STOPS AT and the preset probe temperature of 150°F will show in the display.
- If this temperature is acceptable, press ACCEPT to confirm.

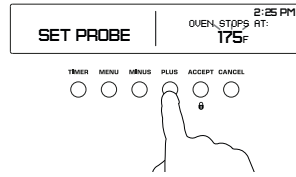

If you would like to adjust the probe temperature:

- ⑧ Press PLUS to edit the probe temperature.
- 150°F will flash.
- ⑨ Press PLUS and MINUS to set the desired probe temperature.
- ⑩ Press ACCEPT to confirm.

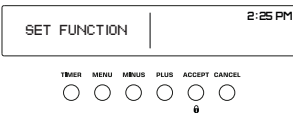

If you have not already set a function and temperature:

- SET FUNCTION will appear in the display.
 - The function knob halo will blink orange.
- ⑪ Select a function and adjust the temperature using the function and temperature knobs

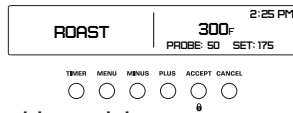

Double models

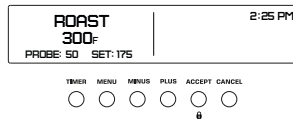

- ⑫ Your oven is now set to automatically turn off when meat probe reaches the set temperature.
- The function and the temperature will show in the display, as well as the current and set temperature of the meat probe.

USING THE MEAT PROBE

To cancel the meat probe at any time

- ① Press MENU once to enter the Automatic Cooking menu.

Double ovens only:

- The display of the oven that is active will flash.
Select which cavity you wish to cancel the meat probe for:

- ①Ⓐ Press PLUS or MINUS to scroll between ovens.

- ①Ⓑ Press ACCEPT to confirm.

- The **SET PROBE** menu appears.
- ② Press and hold CANCEL until the set temperature for the probe disappears.
The oven will remain on.

To cancel the meat probe and turn off the oven at any time

Turn the function knob to OFF.

When the probe preset temperature is reached

- A beep will sound.
- Press any button to stop the beeping.
- The set function and temperature will go out in the display and the oven will stop heating
- Turn the function knob to the Off position to turn the oven off.

Tips for using the meat probe

- You can still use the timer when the meat probe is in use.
- You cannot use the meat probe with Automatic cooking.
- The internal temperature of the meat will continue to rise by 35-45°F / 2-8°C after you have removed it from the oven, so allow for this in your calculations. Cover with foil and let it rest for 15 to 20 minutes.
- If you wish to remove the meat from the oven (eg basting), unplug the meat probe from the socket but do not remove it from the meat. The display will show PROBE: -- . When you are ready to resume cooking, re-insert the probe plug into the socket and the display will again show the internal temperature of the meat.

IMPORTANT!

- **Use only the meat probe supplied with your oven, purchased from your DCS by Fisher & Paykel dealer or replaced under warranty by your nearest DCS by Fisher & Paykel Authorized Repairer.**
- **Hold the meat probe at the handle when inserting and removing it from food and the meat probe socket.**
- **Remember to remove the meat probe from the oven before you start a self-clean cycle.**
- **Do not store the probe in the oven.**
- **Only use the probe with fully defrosted food.**
- **Wash the meat probe in mild soapy water but do not immerse. It is NOT dishwasher safe.**

USER PREFERENCE SETTINGS

You can set your oven to:

- Display time as 12 hr or 24 hr or power save when the oven is not in use
- Display the temperature in degrees Celsius or Fahrenheit
- Operate with sounds on (tones and beeps) or operate quietly
- Operate with oven lights on or off during cooking
- Operate in Sabbath mode (see the following section 'Sabbath Mode')
- Display in the following languages: US English, UK English, CA French and Spanish.

You can also use the User Preference menu to:

- Set the time (see the section 'Setting the Clock' in your Quick Start guide)
- Reset all settings to factory settings

Note: You cannot change the user preference settings when your oven is operating or set for automatic cooking.

How to change preference settings



Single model shown

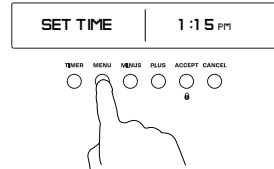
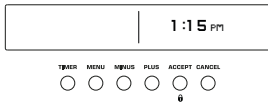

- ① Check the oven function knob(s) are set to OFF and that the display shows the time of day.

- ② Press and hold MENU for a few seconds to enter the user preference menu.
- **SET TIME** will be displayed.

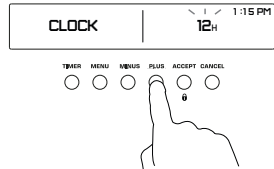
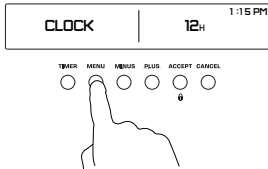

- ③ Press MENU again to scroll through the different settings.

- ④ Press PLUS to select the setting you wish to change.
- The right hand display will flash.

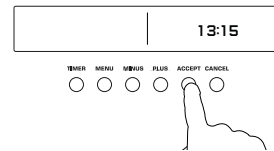
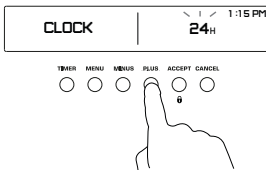

- ⑤ Press PLUS or MINUS to scroll through the options for that particular setting.
- Refer to the table below for which options are available for each setting.

- ⑥ Press ACCEPT to confirm the new option and exit the user preference setting.
- Press CANCEL to quit the user preference menu.

USER PREFERENCE SETTINGS

SETTING	DEFAULT OPTION	ALTERNATIVE OPTION(S)
SET TIME		
The current time will show in the display. See your Quick Start guide for instructions on setting the time.		
CLOCK	24 H	12 H
Select between 24-hour or 12-hour clock display.	24_H	12_H
POWER SAVE MODE**	POWERSAVE MODE ON	POWERSAVE MODE OFF
Set the display to turn off when the oven is not in use.	ON	OFF
DEGREE SCALE	FAHRENHEIT	CELSIUS
Select between degrees Celsius or Fahrenheit.	FAHRENHEIT	CELSIUS
SOUNDS	BEEPS/TONES	BEEPS/TONES
Turn audio feedback (beeps and tones) on and off.*	ON	OFF
OVEN LIGHTS	LIGHTS ON DURING COOKING	LIGHTS OFF DURING COOKING
Have the light off during cooking if you want to save power or want the food you cook to be a surprise for others.	ON	OFF
SABBATH MODE	SABBATH OFF	See 'Sabbath Mode' for instructions.
	OFF	
LANGUAGE	US ENGLISH	UK ENGLISH SPANISH FRENCH
Choose the language you would like the oven to display in.	US ENGLISH	UK ENGLISH ESPANOL FRANCAISE
USER SETTINGS RESET	RESET	Select this option and accept to reset all user settings.
Use this to clear all changes to settings and reset to the factory settings	RESET	

* The timer tone and alert beeps will sound even if you save the BEEPS/TONES OFF option.

** With this option on, when the oven is not in use, the display will go into power save mode and turn off. The display will remain on whenever the oven is in use.

SABBATH MODE

This setting is designed for religious faiths that observe a 'no work' requirement on the Sabbath.

While your oven is in Sabbath mode

- The display, knob halos and indicators will be unlit, the buttons will be unresponsive.
- No tones or beeps will sound.
- No alert codes or temperature changes will be displayed.
- The oven lights will stay on. If you want the oven lights to be off during Sabbath mode, first select the 'Lights off' option as described in 'User preference settings', and only then set Sabbath mode.
- BAKE is the only function available in Sabbath mode.

How to set Sabbath mode

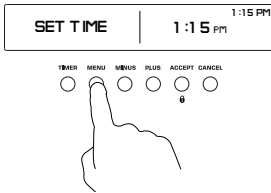

- ① Press and hold MENU for a few seconds to enter the user preference menu.

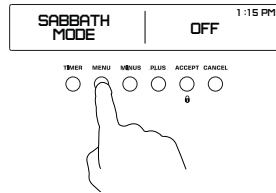

- ② Press MENU again to scroll through the different options to **SABBATH MODE**.
 - The default option is **SABBATH MODE OFF**

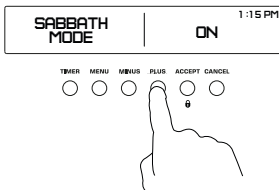

- ③ Press PLUS or MINUS to set **SABBATH MODE ON**
- ④ Press ACCEPT to confirm.

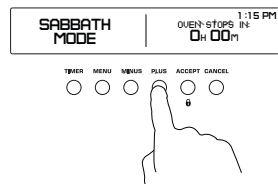

- **OVEN STOPS IN:** will appear in the display.
 - **0H 00M** will flash.
- ⑤ Press PLUS or MINUS to select the length of time the oven will remain in Sabbath Mode.

This can be set for up to 48 hours.
 - ⑥ Press ACCEPT to confirm.

SABBATH MODE

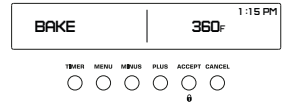
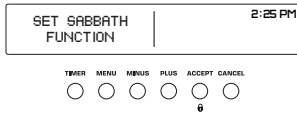

If you have not already set a function and temperature:

- SET SABBATH FUNCTION will appear in the display.
- the function knob halo will blink orange.
- NOTE: BAKE function is the only function available while in Sabbath Mode.

- ⑦ Turn the function knob to BAKE.
- ⑧ Adjust the temperature if necessary.

Double ovens only:

- Set one or both of the cavities to BAKE now, and adjust the temperature if necessary.

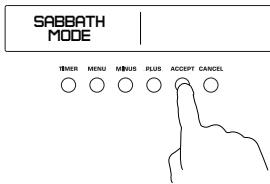

- ⑨ Press ACCEPT to confirm, or wait 30 seconds.
- **SABBATH MODE** will display.

Double ovens only:

- NOTE: If you want to use both cavities in Sabbath Mode, set function and temperature for both cavities before pressing ACCEPT.

The clock, indicators and knob halos will be unlit and unresponsive, but the oven will be on until the time set elapses or you quit Sabbath mode.

To quit Sabbath mode

Either press and hold the CANCEL until the time of day appears in the display, or turn the function knob to Off and the oven(s) will turn off.

CARE AND CLEANING

Removing and replacing the sliding shelves and side racks

- ① To remove a sliding shelf, grip it by its two front corners (making sure you are gripping the wire shelf and the sliding frame together), tilt upwards and pull it out of the oven.
- ② To remove the side racks, gently push the retaining wire from underneath the lock stud, then swing the lowest edge of the side rack up and out towards the center of the oven until the rack is almost horizontal. The prongs at the top will slide out of the mounting slots.
- ③ To replace the side racks, hold them almost horizontally and locate the prongs into the small mounting slots at the top of the oven cavity. While you are doing this, support the rack with your hand from underneath, to ensure that both prongs perfectly locate into the mounting slots.
- ④ Lower the side racks carefully and gently place the retaining wire underneath the lock stud.

IMPORTANT!

Do not lower the side racks until the prongs are fully inserted into the slots so that you do not chip the enamel.

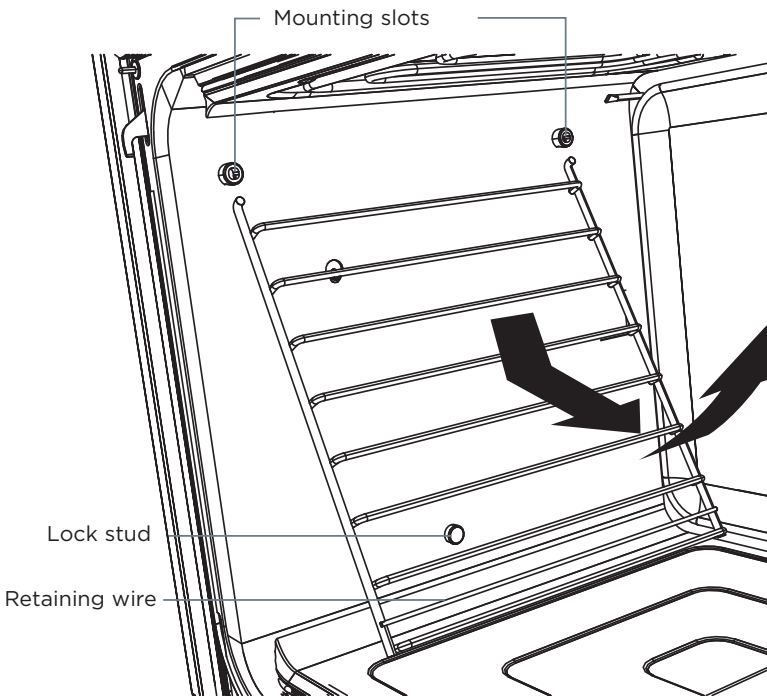

CARE AND CLEANING

Changing the oven light bulbs

The oven is illuminated by three 12 volt/20 watt halogen bulbs. These have a very long life, but if you should need to replace one, use only a replacement bulb purchased from your nearest DCS by Fisher & Paykel dealer and follow these steps:

- ① Allow the oven to cool and then turn it off at the wall.
- ② Take out the shelves and side racks (see 'Removing and replacing the sliding shelves and side racks') and use a small flat-head screwdriver to twist and lift the retainer clip at the top of the glass light cover while holding the glass to prevent it falling. The clip pivots counter-clockwise (see the diagram).
- ③ Carefully lift the glass cover out of the lower support and pull out the faulty bulb.
- ④ Holding the replacement bulb in a soft cloth or tissue (touching the bulb will reduce its life span), insert the new bulb.
- ⑤ Reposition the glass cover and twist the top clip back in place. The procedure is the same for the light in the roof of the oven cavity.

Note: oven bulb replacement is not covered by your warranty.

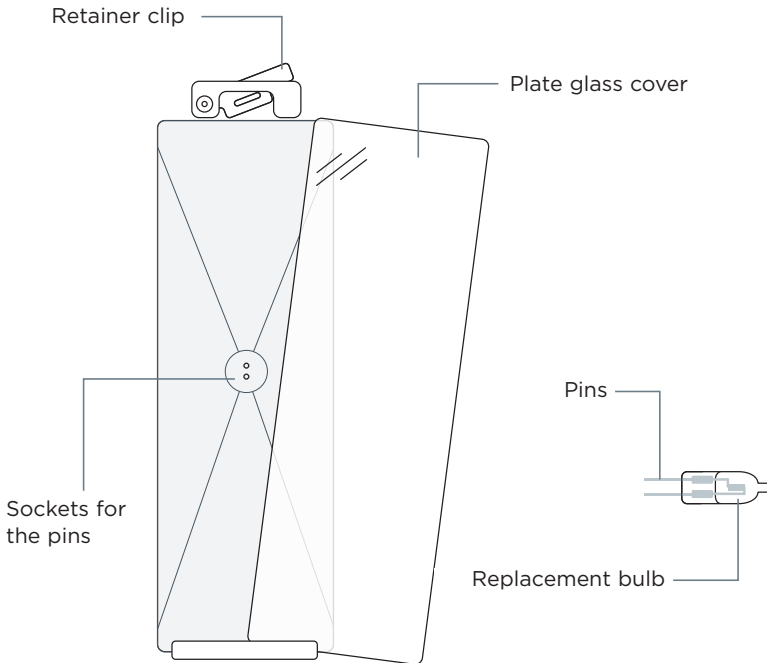

CARE AND CLEANING

Manual cleaning

ALWAYS

- Before any manual cleaning or maintenance, first wait for the oven to cool down to a safe temperature to touch, then turn its power supply off at the wall.
- Read these cleaning instructions and the 'Safety and warnings' section before you start cleaning your oven.
- To prevent soiling from becoming 'baked on' and stubborn, we recommend removing any easy-to-reach spills, food or grease stains from the oven cavity enamel after each use.
- Always clean the inner glass pane before starting a Self Clean cycle (where available).
- Always remove oven shelves and side racks before starting a Self Clean cycle (where available).

NEVER

- Never use a steam cleaner.
 - Never store flammable substances in the oven.
 - Never use abrasive or harsh cleaners, cloths, scouring pads or steel wool. Some nylon scourers may also scratch. Check the label first.
 - Never use oven cleaner on catalytic panels or in a pyrolytic oven.
 - Never leave alkaline (salty spills) or acidic substances (such as lemon juice or vinegar) on the oven surfaces.
 - Never use cleaning products with a chlorine or acidic base.
 - Never spray detergent or liquid onto the buttons on the control panel. Liquid may seep behind the button and damage the electronics.
-

CARE AND CLEANING

Manual cleaning

WHAT?	HOW?	IMPORTANT!
Knobs	Clean with a solution of mild detergent and hot water, then wipe dry.	Do not use stainless steel or oven cleaner on the knobs, as doing so may damage their coating.
Stainless steel strip/handle on the front of the oven door	<ul style="list-style-type: none"> • Clean with a solution of mild detergent and hot water, then wipe dry with a microfibre cloth. • If necessary, use a suitable stainless steel cleaner and polish. 	<ul style="list-style-type: none"> • Always read the label to make sure that your stainless steel cleaner does not contain chlorine compounds as these are corrosive and may damage the appearance of your oven. • Always rub the stainless steel in the direction of the grain.
Aluminium framing of oven door and plastic corner clips	Clean with a solution of mild detergent and hot water, then wipe dry.	
Oven cavity	<ul style="list-style-type: none"> • To clean light soiling off the enamelled surfaces: <ol style="list-style-type: none"> ① Wipe with a damp cloth and a solution of hot water and mild detergent or an ammonia-based cleaner. ② Wipe dry with a soft cloth. • To clean stubborn, 'baked on' soiling or the whole oven cavity: use the Self Clean function. See 'Using the Self Clean function' for instructions. 	<ul style="list-style-type: none"> • To prevent soiling from becoming 'baked on' and stubborn, we recommend removing any easy -to-reach spills, food or grease stains from the enamelled surfaces after each use. Doing so will reduce the need for using the Self Clean function frequently. • Always remove the side racks before a Self Clean cycle • To make wiping out the oven easier you may remove and the oven door. See the following pages for instructions.
Oven door glass	Use a mild solution of detergent and warm water; use a glass cleaner to remove smears.	Do not use sharp metal scrapers or scourers on the glass as it may scratch the surface and cause the glass to shatter.

CARE AND CLEANING

Manual cleaning

WHAT?	HOW?	IMPORTANT!
Telescopic sliding shelf supports	Wipe with a damp cloth and mild detergent. Do not wipe off or wash away the white lubricating grease (visible when the slides are extended).	Do not wash these in the dishwasher, immerse in soapy water, use oven cleaner on them or leave in the oven during a Self Clean cycle (where available) as doing so will remove the white lubricating grease and prevent the slides from running smoothly.
Meat probe	Clean with a solution of mild detergent and hot water, then wipe dry with a microfiber cloth.	<ul style="list-style-type: none"> • Clean after every use to avoid contamination. • Do not wash in the dishwasher, immerse in soapy water, use oven cleaner or leave in the oven during a Self Clean cycle (where available).
Broil pan Side racks Oven shelves	<ul style="list-style-type: none"> • Clean with a solution of mild detergent and hot water. • Pre-soak stubborn burnt-on stains in a solution of dishwasher powder and hot water.. • These parts are dishwasher safe. 	<ul style="list-style-type: none"> • Never leave any of these parts in the oven during a Self Clean cycle. They will become discoloured or damaged.
Oven seal	Do not clean this part.	
Oven vent louvres	Wipe with a damp cloth.	Take care not to let any liquid run down the louvres of the oven vent.

USING THE SELF CLEAN FUNCTION

- During the pyrolytic Self Clean cycle the extremely high temperature burns off and breaks down grime and grease deposits. All that is left is a small amount of grey ash that you can easily remove.
- There is a choice of two Self Clean cycles:
 - **Self Clean** (5 hours) (for normal soiling).
 - **Light Self Clean** (4 hours) (suitable for a light or localised soiling).

Double oven models only:

- Only one oven can be self-cleaned at a time.
- During the Self clean cycle you cannot use the other oven or set Automatic cooking.

IMPORTANT!

- **You must clean the inside glass door panel BEFORE starting a self-clean cycle. Failure to do this may result in permanent staining or marking of the door glass.**
- **Do not use oven cleaners, any degreasing cleaners, or oven liners.**
- **Make sure you remove the side racks, oven shelves and trays and all other bakeware and utensils from the oven before starting a Self Clean cycle. If left in the oven, they will become permanently discoloured or damaged; items made from combustible materials (eg wood, fabric, plastic) may even catch fire.**
- **Do not use your oven to clean miscellaneous parts.**
- **Make sure the room is well ventilated.**
- **Before starting a Self Clean cycle, make sure you move any pet birds to another, closed and well-ventilated room. Some pet birds are extremely sensitive to the fumes given off during a Self Clean cycle, and may die if left in the same room as the oven during such a cycle.**
- **During a Self Clean cycle, the oven reaches higher temperatures than it does for cooking. Under such conditions, the surfaces may get hotter than usual and children should be kept away.**
- **The oven door will be locked during the Self Clean cycle (approximately 3 hours).**
- **If there are cracks or flaws on any of the oven door glass panes, if the oven seal is damaged or worn, or if the door does not close properly, do not start a Self Clean cycle. Call your Authorised Repairer or Customer Care.**

To start a Self Clean cycle

- ① Remove oven shelves, side racks and all other accessories, bakeware, and utensils.
- ② Wipe up any spills. Failure to do so may discolour the oven surfaces.
- ③ Check the inner glass pane of the oven door. If it has soiling on it (eg stains from greasy splatter), you will need to clean it manually before starting a Self Clean cycle. For instructions, see 'Care and cleaning'.

IMPORTANT!

- **If soiling is left on the glass, it will become burnt on during the Self Clean cycle, making it very difficult to remove.**
- ④ Close the oven door firmly.

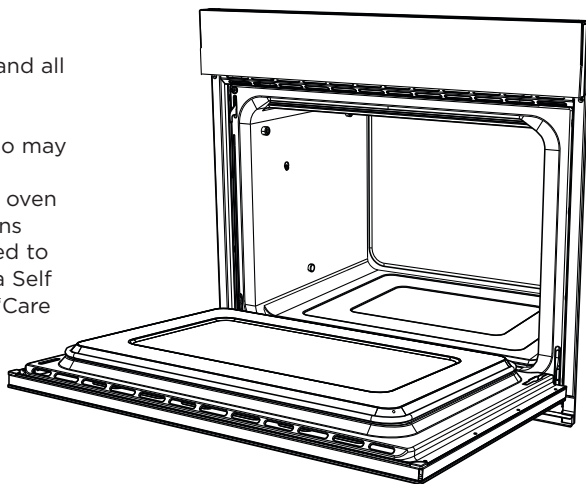

USING THE SELF CLEAN FUNCTION

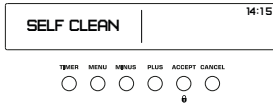

- ⑤ Turn the function knob to **SELF CLEAN**.
- The halo will glow red.

IMPORTANT!

Double ovens only: Ensure the function knob for the other oven is turned to OFF.

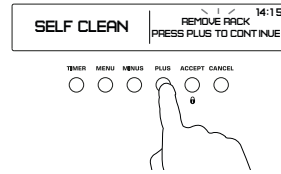

- ⑥ **REMOVE RACK: PRESS PLUS TO CONTINUE** will flash in the display.
- ⑦ Press **PLUS** to confirm that you have removed all oven shelves, trays, and side racks.

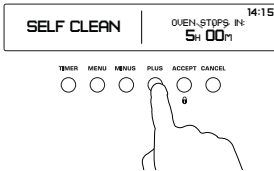

- ⑧ **OVEN STOPS IN** and the self clean cycle length will display and flash.
- There are two cycle times available: 4 hours for light soiling, and 5 hours for normal soiling.
- ⑨ Press **PLUS** or **MINUS** to choose between the different cycle lengths.

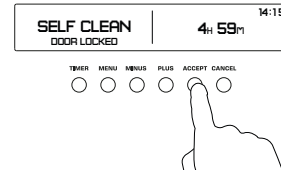

- ⑩ Press **ACCEPT** to confirm the cycle time and start the self clean cycle. The oven is now locked and the length of time for the self clean cycle will begin counting down.
- DOOR LOCKED** will also appear in the display.
 - The time remaining in the self clean cycle will show in the display.

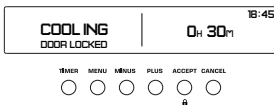

- ⑪ Towards the end of the self clean cycle, the oven will start cooling down.
- COOLING** will appear in the display.
 - The door will remain locked.
 - The display will show the remaining cool down time.

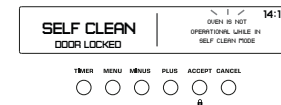

- Double ovens only:**
 - While a self clean cycle is set for one cavity, you cannot use the other cavity for cooking.
 - Self clean can only be set for one cavity at a time.
- During a self clean cycle, if the function knob for the other cavity is turned, a warning will show in the display for a few seconds.*

USING THE SELF CLEAN FUNCTION

When a Self Clean cycle has finished

- A tone will sound
- The door will unlock
- The time of day will remain in the display and the oven switches off.

Turn the function knob to the OFF position.

You need to:

- ① wait for the oven to cool down completely
- ② remove the grey ash with a small brush or damp cloth
- ③ wipe out the oven with a clean damp cloth
- ④ dry with a clean lint-free cloth
- ⑤ replace the side racks and shelves.

To cancel a Self Clean cycle

IMPORTANT!

- A Self Clean cycle can be cancelled at any time by pressing CANCEL.
- The door will not unlock until the oven has cooled to a safe temperature.
Do NOT turn off the mains power supply to the oven (wall switch). Turning off the power while the oven is too hot may damage the oven and its surrounding cabinetry.

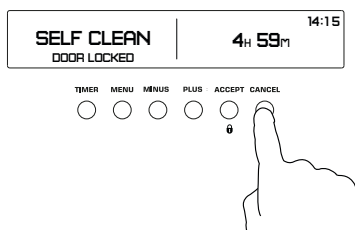

To cancel a Self Clean cycle, press CANCEL.

- If the oven needs to cool down:
 - **COOLING / DOOR LOCKED** will appear in the display.
 - The door will remain locked.
 - The display will show the remaining cool down time.
- When it has cooled down, the oven will turn off, the door will unlock, a long tone will sound and the display will show the time of day.
- We do not recommend cancelling a Self Clean cycle and then immediately starting one again.



TROUBLESHOOTING

Troubleshooting chart

If there is a problem, check the chart below to see if you can fix it. If the problem cannot be fixed or persists, call your Authorised Repairer or Customer Care.

PROBLEM	POSSIBLE CAUSES	WHAT TO DO
General		
The oven does not work.	No power.	Check that the mains power supply (wall switch) is turned on, the fuse has not tripped and there is no power outage in your area.
The oven does not work but the display is lit.	The oven is set for automatic cooking.	See 'Automatic cooking' for instructions.
The lights do not come on when I open the oven door.	The oven light bulb(s) have blown.	Replace the light bulb(s). See 'Care and cleaning' for instructions.
	The door is not correctly fitted.	See 'Care and cleaning' for instructions on fitting the door correctly.
	The oven is in Sabbath setting and the 'Light off' option has been saved.	To quit Sabbath setting, press and hold CANCEL. See 'User preference settings' for instructions on changing the 'Light off' option.
The display shows LOCKED	The control panel is locked.	Press and hold ACCEPT to unlock the control panel.
The oven is not heating.	The door is not properly closed or it is opened too frequently during cooking.	The heating elements are disabled while the door is open. Make sure the door is properly closed and avoid opening it frequently during cooking.
A glass pane in the oven door has cracked, chipped, or shattered.	Incorrect cleaning or the edge of the glass hitting against something.	You must NOT use the oven. Call your Authorised Repairer or Customer Care.

TROUBLESHOOTING

PROBLEM	POSSIBLE CAUSES	WHAT TO DO
General		
I can feel hot air blowing out of the vents after I have turned the oven off.	This is normal.	For safety reasons the cooling fans will continue to run even when you have turned the function knob to 'Off'. The fans will switch off automatically when the oven has cooled.
The oven fan comes on when I select a function that does not use a fan (eg BAKE)	This is normal. The fan comes on while the oven is preheating. It may turn off when the oven has reached the set temperature.	Wait until a long tone sounds and the temperature knob halo turns orange: the oven will then be ready to use.
The oven has reached the set temperature but the temperature knob halo is still white (indicating that the oven is not ready to use).	This is normal: when heating up from cold, your oven is designed to initially heat to a temperature somewhat higher than what you have set. This is to provide optimal baking conditions right from the start.	Wait until a long tone sounds and the temperature knob halo turns orange: the oven will then be ready to use.
The oven is heating but the display is dark.	The oven is in Sabbath setting.	To quit Sabbath setting, press and hold CANCEL until the display shows the time of day.
The oven cancels automatic cooking when I try to adjust the clock setting.	The oven was set for automatic cooking when you were trying to adjust the clock setting.	You can only adjust the clock setting while the oven is not set for automatic cooking.
The oven sounds a tone when I try to turn the temperature knob below a certain temperature.	This is normal: for food safety reasons, the oven functions have factory-set minimum temperature settings.	The temperature knob itself cannot be 'turned off'. Selecting Off with the function knob will turn the oven off.
The temperature knob halo doesn't turn white when I use BROIL/MAXI BROIL	This is normal: the halo stays orange to indicate that the broil element provides instant radiant heat.	

TROUBLESHOOTING

PROBLEM	POSSIBLE CAUSES	WHAT TO DO
General		
The displays work, and the function and temperature knobs halos come on but the oven does not heat up.	The oven is in 'Demo' mode.	Call Customer Care.
The display shows CLOSE DOOR	The door is open during cooking (some functions only).	Ensure the door is shut fully.
The automatic cooking does not display.	You are trying to use a meat probe and automatic cooking	You cannot use the meat probe at the same time as automatic cooking. See 'Using the Meat Probe'
During MAXI BROIL the oven is louder than usual.	This is normal: the oven's cooling fans are operating at their highest speed.	
I cannot start the Sabbath setting.	You have not selected the BAKE function.	You must select BAKE when using the Sabbath setting.
PROBLEM		
POSSIBLE CAUSES		
WHAT TO DO		
Self Clean function		
During a Self Clean cycle, the oven is louder than usual.	This is normal: the oven's cooling fans operate at their highest speed.	
The display shows - -	The meat probe mode has been selected but the meat probe is not plugged in to the socket.	Ensure the meat probe is plugged into the socket. Cancel meat probe by pressing CANCEL.
The display shows CHECK DOOR	The door has not been properly closed.	Make sure you close the door properly.
At a point during a Self Clean cycle, The display changes to show COOLING	This is normal: the oven is in the last phase of the Self Clean cycle, cooling down.	Wait until the Self Clean cycle has finished. A long tone will sound and the oven door will automatically unlock when the oven is ready to use.

TROUBLESHOOTING

PROBLEM	POSSIBLE CAUSES	WHAT TO DO
Self Clean function		
<p>Double oven models only:</p> <p>I cannot select the Self clean function.</p>	<p>One oven is already turned on or set for automatic cooking.</p>	<p>You cannot start a Self Clean cycle when one oven already has a function selected.</p> <p>Turn the function knob to Off and try again.</p>
<p>I have cancelled a Self Clean cycle but cannot use the oven:</p> <ul style="list-style-type: none"> • the oven door will not open • the display is still counting down minutes or showing 0_H 00_M • COOLING is showing in the display • the knobs and buttons are unresponsive. 	<p>This is normal: if COOLING is showing in the display,, you have successfully cancelled the Self Clean cycle. However, the oven is still too hot to be used for cooking and needs to cool down.</p>	<p>Wait until the cool-down phase has finished. A long tone will sound and the oven door will automatically unlock when the oven is ready to use.</p> <p>Note: depending on when the Self Clean cycle was cancelled, the cool-down phase may take up to 45 minutes.</p>
<p>The oven is beeping and the display shows A2 or A3.</p>	<p>See section 'Alert codes' for instructions.</p>	
<p>There is a power cut during a Self Clean cycle.</p>	<p>Power cut.</p>	<p>The door will remain locked. Once the power is turned back on, the door will remain locked until the oven has cooled to a safe temperature.</p>

ALERT CODES

If there is a problem, the oven will:

- automatically suspend all oven functions
- beep five times
- display an alert code.

IMPORTANT!

Do not turn off the mains power supply to the oven (wall switch) if you get an alert code, unless the instructions in the chart following specifically instruct you to. There are cooling fans within the oven which are needed to cool the oven's components. Turning off the power while the oven is too hot may damage the oven and its surrounding cabinetry.

What to do if an alert code is displayed

- ① If the beeping hasn't stopped already, press any button to stop it.
- ② Make a note of the alert code displayed. You may need this information.
- ③ Check the chart following to see if you can fix the problem yourself and follow the instructions.
- ④ If you can fix the problem and the alert code does not reappear, you can keep using your oven.

OR

If you can't fix the problem yourself or the alert code reappears and the problem persists: wait until the cooling fans have stopped and the oven has completely cooled down, then turn the power to the oven off at the wall and call your Authorised Repairer or Customer Care with the alert code information.

ALERT CODES

ALERT CODE	POSSIBLE CAUSES	WHAT TO DO
A1	The oven has overheated.	<ol style="list-style-type: none">① Allow the oven to cool down.② Once the oven has cooled down and the door has unlocked, the alert code will disappear. You can now use the oven again.
A2	Door lock error: the door cannot be locked after you have started a Self Clean cycle.	<ol style="list-style-type: none">① Turn the power to the oven off at the wall and on again.② Wait approximately 10 seconds. This is to allow the door lock to return to its initial position.③ Set the clock. See 'Setting the clock and first use' for instructions.④ Try starting a Self Clean cycle again, making sure that you close the door firmly. See 'Using the Self Clean function'.
A3	Door lock error: the door cannot be unlocked after a Self Clean cycle has finished.	<ol style="list-style-type: none">① Turn the power to the oven off at the wall and on again.② Try pressing on the oven door to help the door lock disengage.③ If this doesn't help and the alert code reappears, call your Authorised Repairer or Customer Care.
F + number	Technical fault.	<ol style="list-style-type: none">① Note down the alert code.② Wait until the cooling fans have stopped and the oven has completely cooled down.③ Turn the power to the oven off at the wall.④ Call your Authorised Repairer or Customer Care with the alert code information.

Before you call for service or assistance ...

Check the things you can do yourself. Refer to the installation instructions and your user guide and check that:

- ① Your product is correctly installed.
- ② You are familiar with its normal operation.

If after checking these points you still need assistance or parts, please refer to the Service & Warranty book for warranty details and your nearest Authorized Service Centre, Customer Care, or contact us through our website www.dcsappliances.com.

Contact details

For replacement parts or if further help is needed concerning this appliance call:

Toll Free 1 888 9 FNP USA (1 888 936 7872)

or write to:

Fisher & Paykel Appliances Inc.
695 Town Center Drive,
Suite 180 Costa Mesa,
CA 92626-1902
USA

or contact us through our web site www.dcsappliances.com

Complete and keep for safe reference:

Model	_____
Serial No.	_____
Purchase Date	_____
Purchaser	_____
Dealer	_____
Suburb	_____
Town	_____
Country	_____

www.dcsappliances.com

Copyright © Dynamic Cooking Systems, Inc. 2016. All rights reserved.
The product specifications in this booklet apply to the specific products and models described at the date of issue. Under our policy of continuous product improvement, these specifications may change at any time. You should therefore check with your Dealer to ensure this booklet correctly describes the product currently available.

US CA

591008 A 03.16