

Insert Range Hood, 24"

Series 7 | Integrated

Stainless Steel and Glass



With edge-to-edge extraction, this range hood is perfectly hidden away in your cabinetry.

- With three fan speeds plus a boost function, select the perfect extraction rate for your cooking
- Perimeter extraction for efficient removal of steam and odors
- Powerful maximum air movement of 400CFM
- Wi-Fi enabled for notifications through the SmartHQ™ app

DIMENSIONS

Height	12 7/16"
Width	20 7/8"
Depth	11"

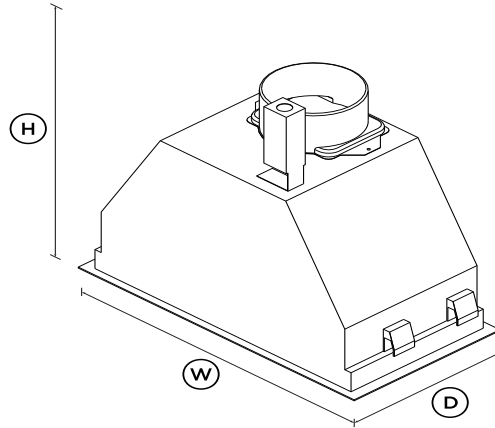

FEATURES & BENEFITS

ACHIEVE THE INVISIBLE

This high quality integrated range hood seamlessly blends behind cabinetry in a variety of kitchen layouts. Beautiful in its simplicity, this product has brushed finished surfaces with no visible screws.

SIMPLE CONTROLS

The intuitive control panel responds to the touch of your finger. LED strip lighting illuminates the entire cooktop surface for the perfect sear or ideal reduction. Range hood settings, including temperature and fan speed, can be controlled via the SmartHQ™ app, with additional voice control options for fan speeds and lighting.

EASY CLEANING

Designed for simple removal, the filters are easy to clean and dishwasher safe, while the glass and stainless steel finish is easily wiped clean. The SmartHQ™ app will notify you when to clean the filter to ensure you get the best performance out of your rangehood.

QUALITY MATERIALS

This rangehood comes in a sleek black glass finish with a real stainless steel frame.

SPECIFICATIONS

Accessories

Aluminium filter	792942
------------------	--------

Accessories (sold separately)

Eave ducting kit	PD-RHK150E
Recirculation carbon filter	792481
Roof ducting kit	PD-RHK150T
Side wall ducting kit	PD-RHK150W

Fan ratings

Maximum air movement	400CFM
Maximum speed sound rating	7.5sones
Speed 1 sound rating	1sones

Installation and cleaning

Air outlet size	6"
Dishwasher safe filters	2
Ducted	Top extraction
Recirculation	Optional - top extraction

Performance	
Extraction type	Perimeter
Fan speeds	3
Filter type	Mesh with perimeter
Number of filters	2
Power requirements	
Supply frequency	60Hz
Supply voltage	120V
Product dimensions	
Depth	11"
Height	12 7/16"
Width	20 7/8"
Product information	
Control type	Capacitive touch
Ventilation features	
Auto-off/Run-on timer	•
Dimmable lights	•
Filter cleaning alert	•
Light type	LED strip
Timer function	•
Wi-Fi connectivity	•
Warranty	
Parts and labor	2 years

SKU 50205

The product dimensions and specifications in this page apply to the specific product and model. Under our policy of continuous improvement, these dimensions and specifications may change at any time. You should therefore check with Fisher & Paykel's Customer Care Centre to ensure this page correctly describes the model currently available. ? Fisher & Paykel Appliances Ltd 2020

Other product downloads available at fisherpaykel.com

- [↓ Service & Warranty](#)
- [↓ User Guide Integrated Insert Rangehood](#)
- [↓ User Guide Integrated Insert Rangehood](#)
- [↓ User Guide Integrated Insert Rangehood](#)
- [↓ Preliminary Specification Guide](#)
- [↓ Data Sheet Insert Rangehood](#)



A PEACE OF MIND SALE

24 Hours 7 Days a Week Customer Support

T 1.888.936.7872 W www.fisherpaykel.com