



User Manual

Modernist Range Hood
DHD30M967/DHD36M987/DHD48M987

Contents

Important Information for Customers	4
Important Safety Information	5
About Safety Symbols and Precautions	5
State of California Proposition 65 Warning (US only)	5
For Your Safety	5
General Safety	6
Product Overview	7
External Features	7
What Is In the Box	8
Operations	9
About the Control Panel	9
Care and Maintenance	13
Hood Care and Cleaning	13
Removing the Filters	13
Cleaning the Filters and Grease Channel	14
Reinstalling the Filters and Grease Channel	14
Replacing the Light Bulbs	14
Hood Replacement Parts	15
Troubleshooting	16
Warranty and Service	17
Getting Help	17
Warranty	17



To Our Valued Customer:

Congratulations on your purchase of the very latest in Dacor® products! Our unique combination of features, style, and performance make us a great addition to your home.

To familiarize yourself with the controls, functions and full potential of your new Dacor hood, read this manual thoroughly, starting with **Important information for Customers** (pg. 4).

Dacor appliances are designed and manufactured with quality and pride, while working within the framework of our company values. Should you ever have an issue with your hood, first check **Troubleshooting** (Pg. 16) for guidance. It gives suggestions and remedies that may pre-empt a call for service.

Valuable customer input helps us continually improve our products and services, so feel free to contact our Customer Assurance Team for assistance with all your product-support needs.

Dacor Customer Assurance Team

14425 Clark Avenue
City of Industry, CA 91745

Telephone: (800) 793-0093 x2813

Fax: (626) 403-3130

Hours of Operation: Mon – Fri, 5:00 A.M. to 5:00 P.M. Pacific Time

Website: www.dacor.com/customer-care/contact-us

Thanks for choosing Dacor for your home. We are a company built by families for families, and we are dedicated to serving yours. We are confident that your new Dacor hood will deliver a top-level performance and enjoyment for decades to come.

Sincerely,

The Dacor Customer Assurance Team

Important Information for Customers

Installer

Leave these instructions with the owner.

Customer

Read this manual completely before using your hood. Save the manual for reference.

For service and warranty information, see Pg. 17.

If you have any questions (other than warranty questions), call:

Dacor Customer Assurance

(800) 793-0093 x2813 (USA, Canada)

Mon – Fri, 5:00 a.m. to 5:00 p.m. Pacific Time

Website: www.dacor.com/customer-care/contact-us

Before calling, have available the hood's model/serial numbers, which are on the data label (interior rear wall above the vents). Write the numbers here for easy reference:

Model number _____

Serial number _____

Purchase date _____

Dacor continually improves its products, so this manual may not reflect the newest ways to use and maintain your appliance. Visit www.dacor.com to download the latest version of this manual:

Important Safety Information

The **Important Safety Instructions** and warnings in this manual do not cover every issue/situation. Use common sense and caution when operating and maintaining your ventilation hood. Contact Dacor Customer Assurance (see Pg. 3) about problems or situations that you cannot resolve.

About Safety Symbols and Precautions

WARNING









Hazards or unsafe practices that may result in **severe personal injury or death**.

CAUTION

Hazards or unsafe practices that may result in minor personal **injury or property damage**.

CAUTION

To reduce risk of fire, explosion, electric shock, or personal injury when using your drawer, follow these basic safety precautions.

-  Do NOT attempt.
-  Do NOT disassemble.
-  Do NOT touch.
-  Follow directions explicitly.
-  Unplug the appliance.
-  Make sure the machine is grounded to prevent electric shock.
-  Call a Dacor Customer Assurance for help.
-  Note

State of California Proposition 65 Warning (US only)



This product contains one or more chemicals known to the State of California to cause cancer and birth defects or other reproductive harm.

For Your Safety

When using electronic appliances, follow basic safety precautions, including:

CAUTION

Use the hood only as described in this manual.

-  **Proper Installation** - Have the hood properly installed and grounded by a qualified technician.
-  **User servicing** - Repair or replace components only as recommended in this manual. All other service should be done by a qualified technician.
-  Always remove the fuse or switch off the circuit breaker before servicing the hood.

Important Safety Information

General Safety

WARNING

To reduce risk of fire, electric shock, and personal injury:

- Do not store/use combustible or explosive items (e.g., gasoline, aerosol cans) near this appliance.
- Use the unit only as intended by the manufacturer. Do NOT vent hazardous/explosive materials or vapors through the hood. If you have questions, contact Dacor.
- Before servicing/cleaning the unit, turn power off at the service panel, and lock the service so power cannot be switched on unexpectedly. If you cannot lock the service, fasten a prominent warning tag to the service panel.
- If you receive a damaged product, immediately contact your dealer/builder. Do not install/use a damaged hood.
- Have the installer show you how to turn ON/OFF power to the hood.
- Do not tamper with the controls.
- Do not let the filters become blocked/clogged, or foreign objects (e.g., cigarettes, napkins) be sucked into the hood.
- Always operate the hood when using your range/cooktop.
- The minimum vertical distance between the cooking surface and the bottom-most part of the hood must be at least 30" (76.2 cm). Consult the Installation Instructions for the minimum vertical distance in your specific case.
- Clean the hood canopy, filters, fans, and other components regularly to prevent grease buildup.

Product Overview

External Features

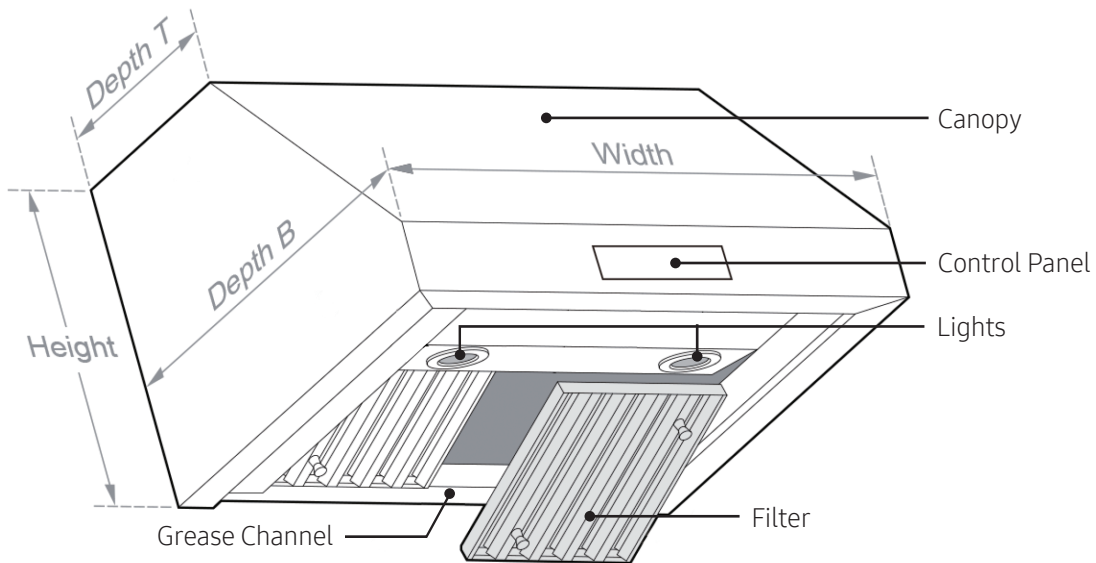

Dimensions

Model	Width	Height	Depth B	Depth T	Filters	Lights
DHD30	30"	18"	24"	11 7/8"	2	2
DHD36	36"	18"	24"	11 7/8"	3	3
DHD48	48"	18"	24"	11 7/8"	4	4

Product Overview

What Is In the Box

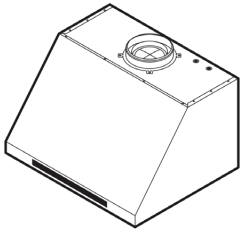

Hood (1)
(30", 36", 48" models)

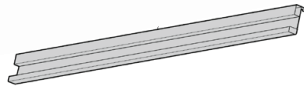

Grease channel (1)

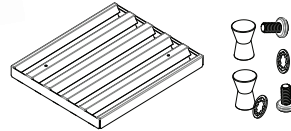

Baffle-style filter
48" (4), 36" (3), 30" (2)

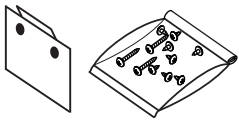

Holding brackets,
hardware (2)



Dimmable LED light bulbs
48" (4), 36" (3), 30" (2)



Light-replacement tool (1)



Installation Instructions,
User Manual



Dacor cleaning cream (1)
Stainless-steel units only

Operations

About the Control Panel

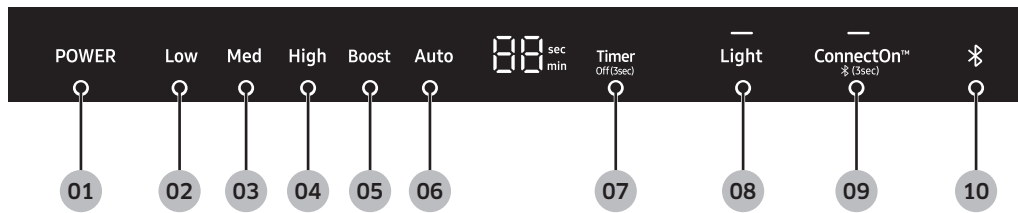

- 01 POWER: Turn on/off the Hood
- 02 Low: Activate the hood at Low speed
- 03 Med: Activate the Hood at Medium speed
- 04 High: Activate the Hood at High speed
- 05 Boost: Activate the Hood at maximum speed
- 06 Auto: Decrease the temperature.
- 07 Timer: Set the Timer
- 08 Light: Turn on/off the lights
- 09 ConnectOn™: Activate ConnectOn™
- 10 Bluetooth indicator

Before You Start

1. Install the LED Lamps provided in the installation kit.
2. By the tab in the top-right corner of the control panel, peel off the protective film.
3. Install the filters.

Using the Fan

Fan speed is shown by the word that appears on the fan-speed portion of the display bar.

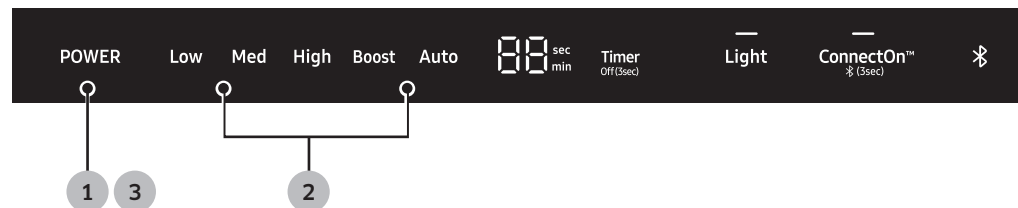

1. Press **POWER** to turn on the fan (at the lowest speed).
2. Press **Med/High/Boost** to change the speed.
3. Press **POWER** to turn off the fan.

Operations

About the Control Panel, cont.

Important Operating Tips

- Always operate the hood when cooking.
- Turn the hood on a few minutes before cooking to establish airflow.
- Adjust the fan speed to the volume and weight of the food being cooked.
- Shut nearby windows and doors, turn off ceiling fans, and close nearby vents to reduce drafts.
- Place your largest pots and pans on the back burners when possible.

Energy-Saving Tips

- For best function, keep the filter system and hood surfaces free of grease and debris.
- Select cookware (size, material, construction) appropriate to the cooking task.

Using the Lights

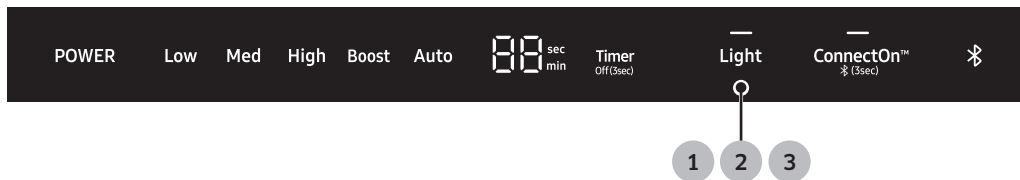

1. Press **Light** to turn on the lights (at the highest setting).
2. Press **Light** again to dim the lights.
3. Press **Light** a third time to turn the lights off.

Setting/Turning Off the Timer

Your hood has a timer that automatically turns the fan off.

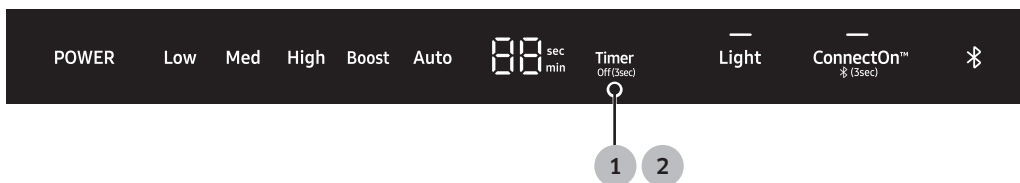

1. Press **Timer** to set your operating time.

NOTE

Each time you press **Timer**, 10 min. are added to the display time, up to a max. of 99 min.

2. Press **Timer** for 3 sec to cancel the timer setting.

Operations

About the Control Panel, cont.

Muting/Unmuting the Control-Panel Sound

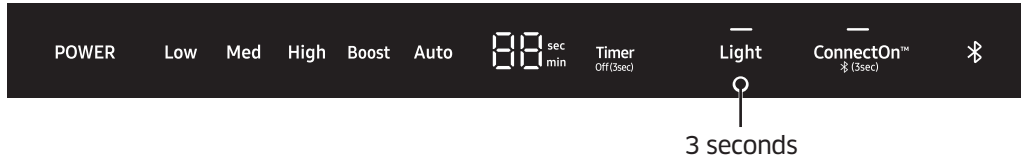

1. Press-hold **Light** for 3 seconds to mute the control panel sound (beep).
2. Press-hold **Light** again for 3 seconds to enable the sound (beep).

Resetting the Clean Filter Light

Every 50 hours of fan use, Low LED blinks to indicate clean filter, prompting you to see if the filters need cleaning.

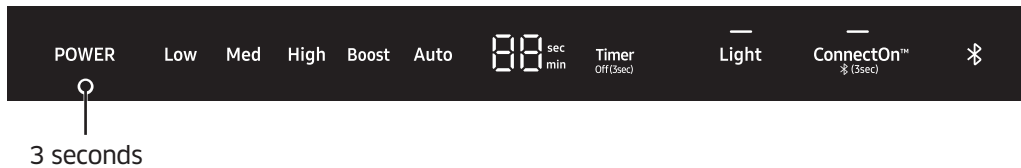

1. To reset the Clean Filter light, press-hold **POWER** for 3 seconds.
2. Clean the filters if needed. (See **Cleaning the filters and grease channel**, Pg. 14).

About the Auto-ON Safety Feature

To protect the electronics from heat damage, the fan automatically turns ON if Auto-ON is enabled or if the unit is connected via Bluetooth with a Dacor cooktop and the cooktop is on. Press **POWER** to manually turn off the fan. Fan speed increases with heat.

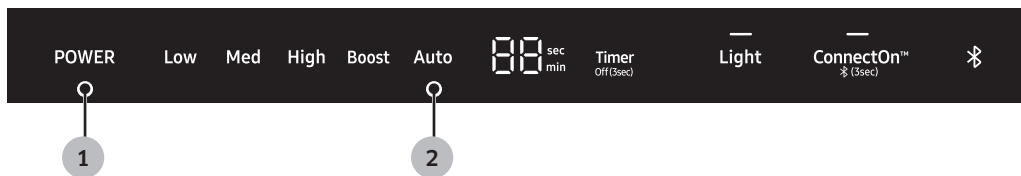

1. Press **POWER**, or select another fan speed.
The Auto Light turns OFF.

About ConnectOn™

- Set up ConnectOn™ on your compatible Dacor cooktop.
- The hood has a feature for pairing with compatible Dacor cooktops via Bluetooth.
- After pairing is established, you can download the Dacor Smart Home app to a mobile device, and use it to monitor and control hood functions.
- For details, visit www.dacor.com.

Operations

About the Control Panel, cont.

About ConnectOn™, cont.

Before Using ConnectOn™

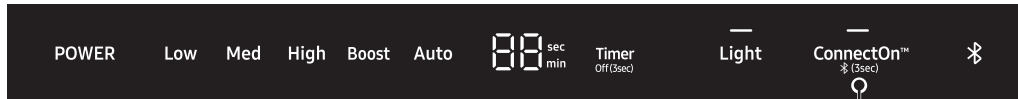

1. Press ConnectOn™ for 3 seconds.
Pairing mode activates, and the Bluetooth indicator blinks.
2. Press **Bluetooth** on your compatible Dacor cooktop to pair the two appliances.

NOTE

For details about the pairing method, see a compatible Dacor cooktop's user manual.

3. Press-hold the Bluetooth button for 3 seconds again.

Using ConnectOn™

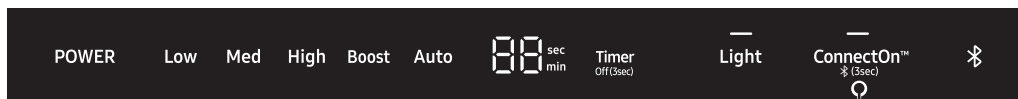

1. Press ConnectOn™ to activate this function.
2. Turn on the cooktop.
The hood activates automatically (default : Auto).

Care and Maintenance

Hood Care and Cleaning

Cleaning Stainless-Steel and Painted Surfaces

- Use a dry cloth to wipe dust, water, etc. from the power plug terminals and contact points.
- Clean stainless-steel and painted surfaces with a solution of dishwashing liquid and warm water, always wiping with the grain. (For best results, Dacor recommends using Dacor Stainless-Steel Cleaner, according to package directions).
- Do not clean with abrasive cleaners or abrasive cloths.
- Rinse and dry with a micro-fiber or other soft, lint-free cloth.
- Do not use benzene, thinner, or home/car detergent to clean the hood.
- Do not spray water onto the hood. This may cause electric shock.
- Do not insert foreign objects into the hood.

Control Panel

- Clean the control panel with a soft cloth dampened with a detergent-hot water solution.
- Rinse and dry with a soft cloth.
- Take care to keep liquids from entering the seams around the control panel.
- Do not use abrasive cleaners or scrubbers.

! WARNING

To avoid the risk of fire/electric shock/personal injury:

- Turn off power to the hood at the circuit-breaker panel or fuse box before cleaning.
- Clean the hood only as directed with the cleaning solutions specified in this manual.
- Thoroughly dry the filter(s) immediately after cleaning.
- To avoid damaging the fan, do not reinstall damaged filters.

Removing the Filters

The filters are under the hood toward the rear. These external components lie directly above all heat, steam, and particulates that are drawn upward into the blower(s).

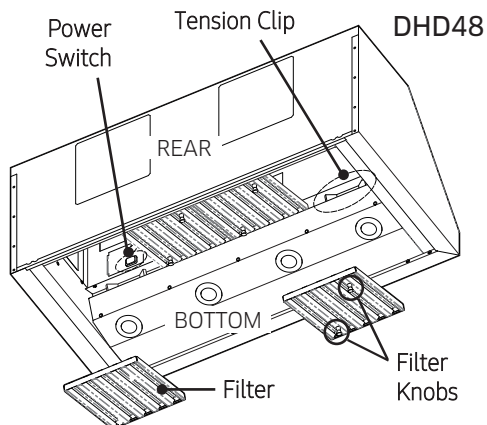

- Tension clips at the front of the hood hold the filters in place.
- You can easily access the main power switch when the filter beneath it is removed.
- In performing this procedure, take care not to bump the switch or scratch the grease channel along the hood's bottom-rear edge.
- If you cannot reach the filters from the floor, Dacor recommends you use a stepstool or similar sturdy device to help you reach up into the hood.

Care and Maintenance

Cleaning the Filters and Grease Channel

If you cannot reach the channel from the floor, use a stepstool or similar sturdy device to help.

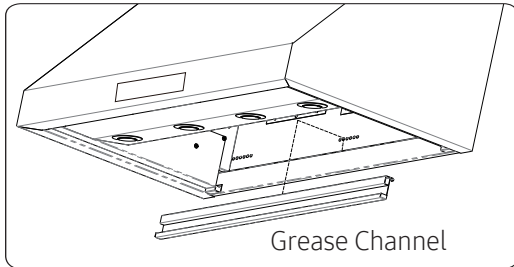

1. Unhinge (lift with both hands), and clean the grease channel with a hot, soapy sponge.
2. Wash the filters in hot, soapy water, or in a dishwasher.
3. Thoroughly dry the grease channel and filters.

Reinstalling the Filters and Grease Channel

1. Reattach the grease channel.
2. Grasping the knobs, press the filter's front edge against the tension clip until the filter's rear edge clears the grease channel.
3. Carefully raise the filter's rear edge up into the hood.
4. Gently release tension on the clip, and rest the filter's rear edge on the grease channel.
5. Wipe away fingerprints, and adjust the components as needed.

Replacing the Light Bulbs

⚠ WARNING

To reduce risk of fire, electric shock, and personal injury:

- The owner changes the bulb. Before replacing a bulb (or if a light does not work), verify that power is ON at the circuit breaker, fuse box, light switch, or main power switch.
- Turn power OFF at the fuse box or circuit breaker panel before replacing the bulb.
- Use bulbs no stronger than 7.5W LED or 75W, 120V Halogen.
- Ensure the hood and bulb lens are cool before changing the bulb.
- Use only dimmable bulbs.

Care and Maintenance

Replacing the Light Bulbs, cont.

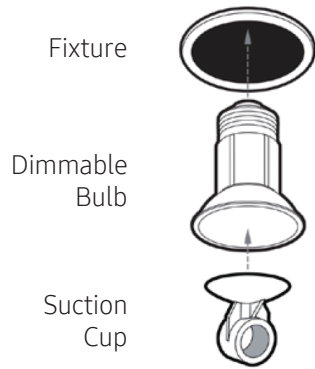
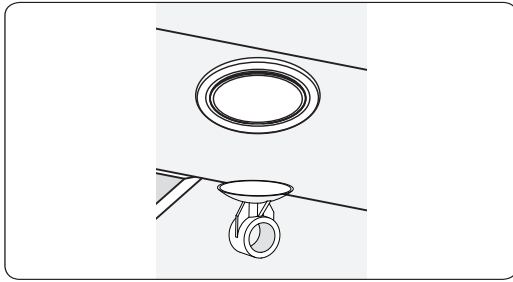

1. (To avoid harming the appliance electrical system should a short occur) Turn power OFF at the circuit breaker or fuse box.
2. Wipe the bulb lens clean, then gently press the suction-cup tool onto the lens.
3. Turn the tool left to loosen the bulb, then remove the bulb from the housing.
4. Attach the suction-cup tool to the lens of the replacement bulb.
5. Insert the bulb into the housing, and turn the tool handle right to tighten the bulb.
6. Remove the suction cup, and turn the power ON at the fuse box or circuit panel.

NOTE

- If buying your own bulb, take the old bulb to the store as reference, or use these specifications: Dimmable LED 7.5W (max) or dimmable halogen 75W (max), 120V; PAR16, E26/27, 500 lumens.
- If the bulb does not engage, ensure the new bulb's lens is clean, then repeat Steps 4 and 5, being sure to insert the bulb fully into its housing.

Hood Replacement Parts

Order at www.everything.dacor.com

Dacor Part #	Description
702666	Dimmable LED Bulb Replacement Kit (1 bulb + 1 suction cup tool)
702579	Baffle Filter Kit (1 pc + hardware)
702580	Baffle Filter Kit (2 pc + hardware)

Dacor hoods use either baffle or mesh filters. Contact Dacor Customer Assurance for assistance.

This table shows the model numbers and descriptions of the available filter types:

Model #	Description
AWHBF2/3/4	Baffle filter: 30" (2 filters); 36" (3 filters); 48" (4 filters)

Troubleshooting

This table lists various minor problems concerning hood issues, possible causes, and solutions. If you have an issue listed in this table, try resolving the issue by applying the corresponding solution. If you cannot resolve the issue, contact Dacor. (See **Warranty and Service** (Pg. 17), for contact info.

Problem	Cause(s)	Solution
Nothing works (control panel not lit; fan/lights not working)	Main power switch is OFF; Power to hood OFF	Check hood's main power switch; turn on power at source; check for tripped breaker or blown fuse.
	Power outage	Call your electric company
	Hood not connected to power source	Have electrician connect hood to power source.
Light(s) not working (control panel lit; fan working)	Light bulb loose	Screw in bulb completely (Pg. 14).
	Light bulb burned out	Replace bulb (Pg. 14).
Fan not drawing heat and smoke properly	Fan speed too low	See Operating Instructions section.
	Filters clogged/dirty Open window, draft, HVAC interference	Ensure filters are clean and free of grease/debris; check for drafts and airflow interference.
	Damper jammed shut; ducting clogged	Consult qualified installation professional*.
Fan shuts off by itself	Hood's "Timed" feature was set	If timer is set, fan turns off after set time. Max time: 99 min. (Setting/Turning off the timer, Pg. 10).
Fan not working (control panel lit; lights working)	Fan electrical malfunction	Call for service.
Fan comes on by itself	AUTO-ON was started	Exhaust fan starts automatically if Auto-ON is enabled or if unit is paired via Bluetooth with a Dacor cooktop and the cooktop is on; press POWER to turn off the fan.
ConnectOn™ not working	The hood is not connected to the cooktop.	Only a Dacor-compatible cooktop can be paired with the hood. (See Before Using ConnectOn™, Pg. 12.)
Bluetooth light blinks or shuts off automatically	The hood has trouble connecting to a compatible range or cooktop	Reset bluetooth on hood: Press-hold both Light and ConnectOn for 5 sec's (display shows bT and changes to rT)

* Dacor does not manufacture/warrant/service the ducting that vents heat/smoke from the hood's chimney to the outside. The owner shall have a qualified person install/maintain the ducting.

Warranty and Service

Getting Help

Before requesting service:

1. Review **Troubleshooting** (Pg. 16).
2. Familiarize yourself with the cooktop's warranty terms and conditions.
3. If none of the previous suggestions resolves your issue, call Dacor Customer Assurance:

Hours of Operation: Mon – Fri, 5:00 am to 5:00 pm Pacific

Time Phone: (800) 793-0093 x2813 (USA, Canada)

Website: www.dacor.com/customer-care/contact-us

Warranty

Review this section to learn the warranty and non-warranty terms and conditions concerning this product. For details/clarifications, contact Dacor.

What Is Covered

CERTIFICATE OF WARRANTIES: DACOR OVENS

WITHIN THE 50 STATES OF THE USA, THE DISTRICT OF COLUMBIA, AND CANADA*:

FULL 2-YEAR WARRANTY

The warranty applies only to the Dacor Modernist appliance sold to the original purchaser, starting from the original retail purchase date or closing date for new construction, whichever period is longer. The warranty is valid on Modernist products purchased new from a Dacor Authorized Dealer, or other Dacor-authorized seller.

If, within 2 years of the original purchase date, your Dacor Modernist product malfunctions due to material or manufacturing defect, Dacor will restore the unit to its proper function free of charge. All cosmetic damage (e.g., scratches on stainless steel, paint/porcelain blemishes, etc.) to the appliance or included accessories must be reported to Dacor within 60 days of the original purchase date to qualify for warranty coverage.

*Warranty is null and void if non-ETL- or non-CUL-approved appliance is transported from the USA.

LIMITATIONS OF COVERAGE

Service will be provided by a Dacor-designated service company during regular business hours. Service providers are not agents of Dacor. Dealer display and model home display products with a production date greater than 5 years, products sold "As Is," and products installed for non-residential use, which include but are not limited to religious organizations, fire stations, bed and breakfast, and spas carry a one year parts warranty only. All delivery, installation, labor costs, and other service fees are the responsibility of the purchaser. Warranty will be null and void on product that has altered, defaced, or missing serial numbers and tags.

The owner must provide proof of purchase or closing statement for new construction upon request. All Dacor products must be accessible for service. Warranty is null and void if non-ETL or non-CUL approved product is transported from the U.S.A.

Warranty and Service

Warranty, cont.

OUTSIDE THE 50 STATES OF THE USA, DISTRICT OF COLUMBIA, AND CANADA: LIMITED 1ST-YEAR WARRANTY

If, within 1 year of the original purchase date, your Modernist appliance malfunctions due to material or manufacturing defect, Dacor will furnish a new part, FOB factory to replace the defective part. All delivery, installation, labor costs, and other service fees are the owner's responsibility.

What Is Not Covered

- Slight color variations due differences in painted parts, kitchen lighting, product location, and other factors; this warranty does not apply to color variation.
- Service calls to educate the customer on proper use and care of the product.
- Service fees for travel to islands and remote areas, which include but are not limited to, ferries, toll roads or other travel expenses.
- Consequential or incidental damage, including but not limited to food or medicine loss, time away from work or restaurant meals.
- Failure of the product when used for commercial, business, rental or any application other than for residential consumer use.
- Consumable parts (e.g., filters, light bulbs).
- Failure of the product caused by improper product installation.
- Replacement of house fuses, fuse boxes or resetting of circuit breakers.
- Product damage due to accident, fire, flood, power outage/surge, or other so-called acts of God.
- Liability or responsibility for damage to surrounding property including cabinetry, floors, ceilings and other structures or objects around the product.
- Breakage, discoloration, or damage to glass, metal surfaces, plastic components, trim, paint or other cosmetic finish caused by improper usage, care, abuse or neglect.

Out of Warranty

Should a service issue arise beyond the standard warranty period, contact us. Dacor reviews each issue and customer concern to provide the best possible solution based on the circumstances. THE REMEDIES PROVIDED IN THE ABOVE EXPRESS WARRANTIES ARE THE SOLE AND EXCLUSIVE REMEDIES. THEREFORE, NO OTHER EXPRESS WARRANTIES ARE MADE, AND OUTSIDE THE FIFTY STATES OF THE UNITED STATES, THE DISTRICT OF COLUMBIA AND CANADA, ALL IMPLIED WARRANTIES, INCLUDING BUT NOT LIMITED TO, ANY IMPLIED WARRANTY OF MERCHANTABILITY OR FITNESS FOR A PARTICULAR USE OR PURPOSE, ARE LIMITED IN DURATION TO ONE YEAR FROM THE DATE OF ORIGINAL PURCHASE. IN NO EVENT SHALL DACOR BE LIABLE FOR INCIDENTAL EXPENSE OR CONSEQUENTIAL DAMAGES. IN THE EVENT DACOR PREVAILS IN ANY LAWSUIT, DACOR SHALL BE ENTITLED TO REIMBURSEMENT OF ALL COSTS AND EXPENSES, INCLUDING ATTORNEY'S FEES, FROM THE DACOR CUSTOMER. NO WARRANTIES, EXPRESS OR IMPLIED, ARE MADE TO ANY BUYER FOR RESALE.

Some states do not allow limitations on how long an implied warranty lasts, or do not allow the exclusion or limitation of inconsequential damages, therefore the above limitations or exclusions may not apply to you. This warranty gives you specific legal rights, and you may also have other rights that vary from state to state.



Please visit www.dacor.com to activate your warranty online.

WARRANTY INFORMATION

**IMPORTANT:**

Your warranty will not be activated until you activate it online or return this form to Dacor. If you have purchased more than one Dacor product, please return all forms in one envelope, or activate the warranty online for each product.

Please be assured that Dacor will never sell your name or any information on this form for mailing-list purposes, as we do not consider it a proper way of expressing our gratitude for your having chosen Dacor products for your kitchen!

Owner Last Name (please print) _____ First _____ Middle Init. _____

Street _____

City _____ State _____ Zip _____

Purchase Date _____ Email _____ Phone _____

Dealer _____

City _____ State _____ Zip _____

Your willingness to take a moment to complete the section below is sincerely appreciated. Thank you.

1. How were you first exposed to Dacor products? (Please check one.)

- A. TV Cooking Show
- B. Magazine
- C. Appliance Dealer Showroom
- D. Kitchen Dealer Showroom
- E. Home Show
- F. Builder
- G. Architect/Designer
- H. Another Dacor Owner
- I. Model Home
- J. Other _____

2. Where did you buy your Dacor appliance(s)?

- A. Appliance Dealer
- B. Kitchen Dealer
- C. Builder Supplier
- D. Builder
- E. Other _____

3. For what purpose was the product purchased?

- A. Replacement only
- B. Part of a Remodel
- C. New Home
- D. Other _____

4. What is your household income?

- A. Under \$75,000
- B. \$75,000 – \$100,000
- C. \$100,000 – \$150,000
- D. \$150,000 – \$200,000
- E. \$200,000 – \$250,000
- F. Over \$250,000

5. What other brands of appliances do you have in your kitchen?

- A. Cooktop _____ C. Dishwasher _____
- B. Oven _____ D. Refrigerator _____

6. Would you buy or recommend another Dacor product?

- Yes
- No

Comments _____

Thank you very much for your assistance. The information you have provided is extremely valuable in helping us plan for the future and in giving you the support you deserve.



cut here

cut here

fold here



NO POSTAGE
NECESSARY
IF MAILED
IN THE
UNITED STATES

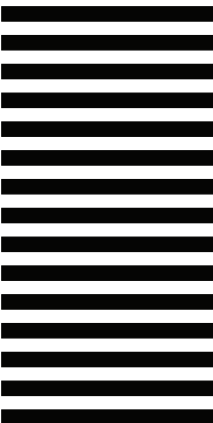

BUSINESS REPLY MAIL
FIRST-CLASS MAIL PERMIT NO 1600 CITY OF INDUSTRY CA

POSTAGE WILL BE PAID BY ADDRESSEE

**DACOR
ATTN WARRANTY PROCESSING DEPT
PO BOX 90070
CITY OF INDUSTRY CA 91715-9907**

