

SI(B)523 | ALITO Collection



Island Hood

Strong and incredibly quiet, the SI(B)523 makes a powerful statement in any kitchen. It features mesh or baffle filters, four bright LED lights for optimal lighting and a highly efficient motor. The bold design and strong stainless steel frame encasing the fan will make this machine the focus of your kitchen. Fitted with a time-delay OFF feature up to nine minutes.

Green Features



3 Speed Push Button Control Panel



Long-Lasting LED Lights



Time-Delay OFF Feature



Grease Cup



Model	Colour	Ducting	Filters	Size	CFM
SI52330	Stainless Steel	6"	Mesh	30"	600
SI52336	Stainless Steel	6"	Mesh	36"	600
SIB52330	Stainless Steel	6"	Baffle	30"	600
SIB52336	Stainless Steel	6"	Baffle	36"	600

Cyclone Range Hoods Inc.

1361 Huntingwood Drive, Unit 16. Toronto, ON. M1S 3J1. Canada.

Toll Free: 1-888-293-5662 Tel: (416) 293-0933 Fax: (416) 293-4793 Website: www.CycloneRangeHoods.com

SI(B)523 | ALITO Collection



Features

- Island range hood
- 6" round duct adapter
- Non-stick aluminum fan blades
- 3 speed push button control
- 4 LED lights(4 x 1.4W, 4000K)
- Quick release aluminum mesh filters
- Standard chimney fits up to 9 ft. ceiling
- Up to 9 minutes time-delay OFF feature
- Plug-in connection

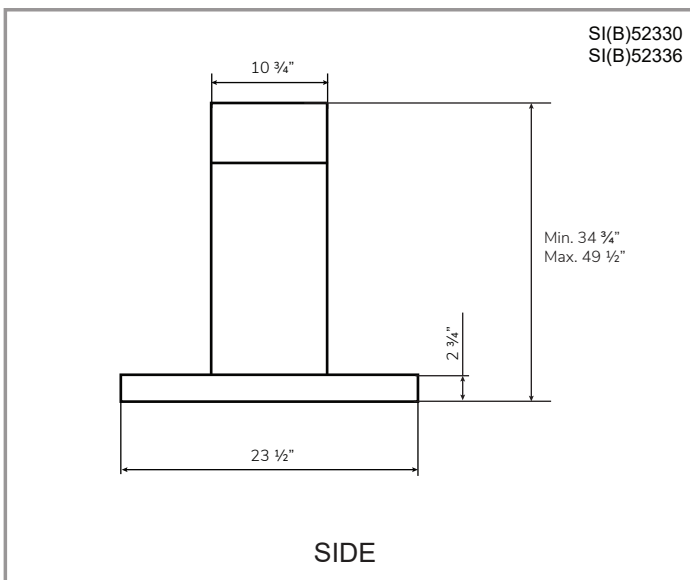
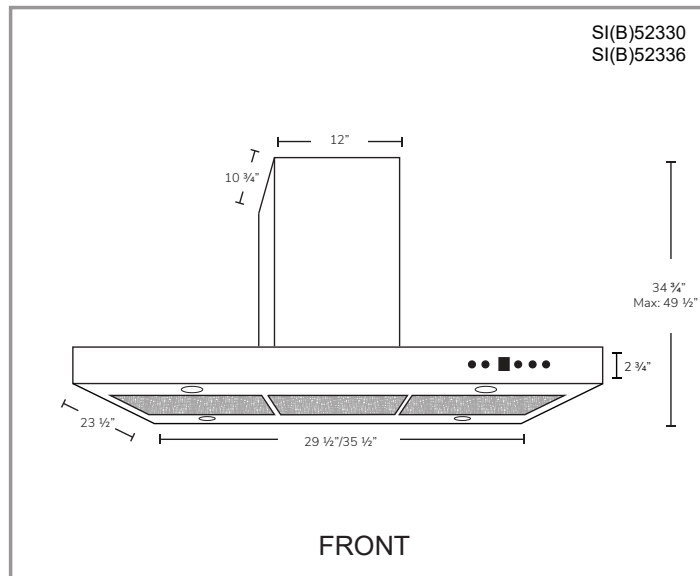

Options

- Filters:
 - SI523 - Quick Release Aluminum Mesh Filters
 - SIB523 - Quick Release Stainless Steel Baffle Filters
- Chimney Flues:
 - IS1.CH16 - short (7'-8' ceilings)
 - IS1.CH24 - standard (8'-9' ceilings)
 - IS1.CH32 - extended (9'-11' ceilings)
- Widths: 30", 36"

Specifications

- | | | |
|--|--|--|
| <ul style="list-style-type: none">▪ Air Flow Volume: 600 CFM▪ Electrical Connection: 120 V/60 Hz▪ Power Consumption: 300 Watts | <ul style="list-style-type: none">▪ Current: 2.5 Amps▪ Fan Speed: 1599 RPM▪ Fan Type: Centrifugal Blower | <ul style="list-style-type: none">▪ Finishes: Stainless Steel▪ Ducting: 6" Round▪ Noise Level: Min. 2 Sones
Max. 6 Sones |
|--|--|--|

