

SC(B)501 | ALITO Collection



Wall Mount

A very attractive exhaust fan, the SC(B)501 is the perfect balance of substance and style. The arched glass canopy frames a classic design giving it a modern appeal. The hood features a three-speed digital control panel. Two LED lights, two mesh or baffle filters and a quiet, efficient motor. Fitted with a time-delay OFF feature up to nine minutes.



Green Features



3 Speed Push Button Control Panel



Long-Lasting LED Lights



Time-Delay OFF Feature



Grease Cup

Model	Colour	Ducting	Filters	Size	CFM
SC50130	Stainless Steel	6"	Mesh	30"	550
SC50136	Stainless Steel	6"	Mesh	36"	550
SCB50130	Stainless Steel	6"	Baffle	30"	550
SCB50136	Stainless Steel	6"	Baffle	36"	550

Cyclone Range Hoods Inc.

1361 Huntingwood Drive, Unit 16. Toronto, ON. M1S 3J1. Canada.

Toll Free: 1-888-293-5662 Tel: (416) 293-0933 Fax: (416) 293-4793 Website: www.CycloneRangeHoods.com

SC(B)501 | ALITO Collection



Features

- Wall mount range hood
- 6" round duct adapter
- Non-stick aluminum fan blades
- 3 speed push button control
- 2 LED lights (2 x 1.4W, 4000K)
- Quick release aluminum mesh filters
- Standard chimney fits up to 9 ft. ceiling
- Up to 9 minutes time-delay OFF feature
- Plug-in connection

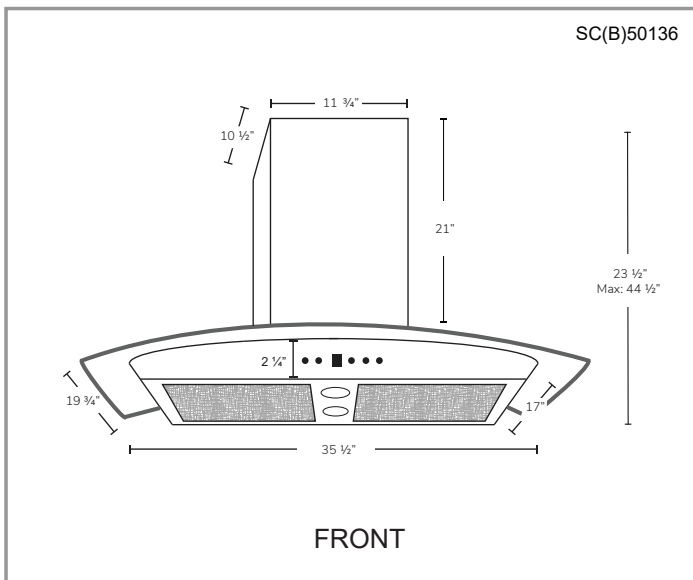
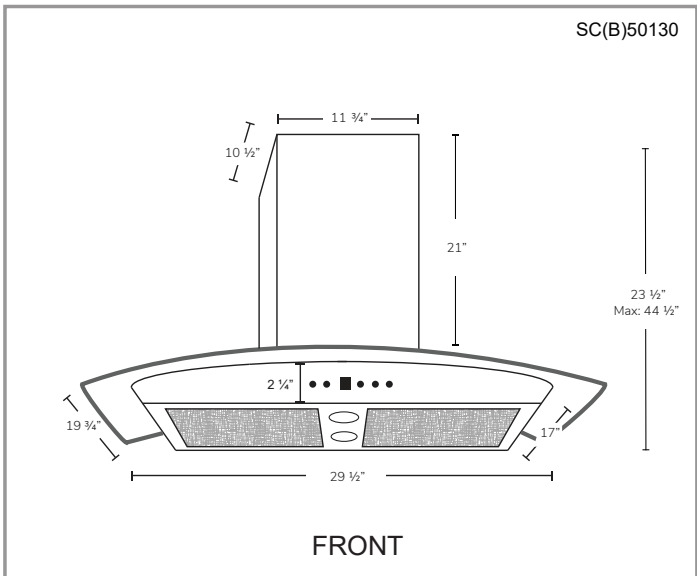

Options

- Filters:
 - SC501 - Quick Release Aluminum Mesh Filters
 - SCB501 - Quick Release Stainless Steel Baffle Filters
- Chimney Flues:
 - B1.CH16 - short (7'-8' ceilings)
 - B1.CH22 - standard (8'-9' ceilings)
 - B1.CH32 - extended (9'-11' ceilings)
- Widths: 30", 36"

Specifications

- | | | |
|--|--|--|
| <ul style="list-style-type: none">▪ Air Flow Volume: 550 CFM▪ Electrical Connection: 120 V/60 Hz▪ Power Consumption: 300 Watts | <ul style="list-style-type: none">▪ Current: 2.5 Amps▪ Fan Speed: 1599 RPM▪ Fan Type: Centrifugal Blower | <ul style="list-style-type: none">▪ Finishes: Stainless Steel▪ Ducting: 6" Round▪ Noise Level: Min. 2 Sones
Max. 6 Sones |
|--|--|--|

