

Cyclone®

Self-Cleaning Range Hoods Undermount Range Hoods



NA940D



CY917R / CY919R



CYB919R



NA330R



PTB56



PTB8 Series

Installation and Operation Instructions

Please read all instructions before installing and operating.

All wiring and installation must be in accordance with CEC, NEC and local electrical codes.

READ AND SAVE THESE INSTRUCTIONS



IMPORTANT SAFETY INSTRUCTIONS

WARNING

- This appliance must be installed by a qualified technician.
- The manufacturer declines all responsibilities in the event of failure to observe the instructions given here for installation, maintenance and suitable use of the product.
- The manufacturer further declines all responsibility for injury due to negligence, and the warranty of the unit automatically expires due to improper installation and maintenance.

CAUTION

- Suitable for use in household cooking area.
- For residential cooking use only. Do not use to exhaust hazardous or explosive materials or vapors.
- Two installers are recommended because of the size and weight of this hood.
- Do not use more than 60 watts incandescent light bulbs for any model. Do not use round shaped light bulb for models CY1000C, CY1000R, NA930C, NA930R, and NA940D. Recommended use 23W florescent tube (equivalent to a 90 watts incandescent light bulb).
- Do not use more than 25 watts per halogen bulb for models CYS1000R, and CY1011R. Light bulbs combined are not to exceed 50 watts.
- Use LED bulb, 1.4W maximum per bulb, for CY3000R.
- Use LED puck light, 1.4W maximum per light, for NA330R, PTB56 and PTB8 series.
- *Bulb & socket may change.

WARNING

TO REDUCE THE RISK OF RANGE TOP GREASE FIRE:

1. Never leave the range unattended at high settings.
2. Always turn hood ON when cooking at high heat or when flaming food.
3. Use proper pan size. Always use cookware appropriate for the size of the surface element.
4. Keep fan, filters and grease laden surfaces clean. Clean ventilating fans frequently. Do not allow grease to accumulate on fan or filter.
5. Use HIGH setting on hood only when necessary.
6. Don't leave hood unattended when cooking.
7. To reduce the risk of fire, use only metal ductwork.
8. This unit must be grounded.
9. Not for outdoor use.

WARNING

TO REDUCE THE RISK OF FIRE, ELECTRIC SHOCK, OR INJURY TO PERSONS, OBSERVE THE FOLLOWING:

1. Use this unit only in the manner intended by the manufacturer.
2. Before servicing or cleaning the unit, switch power off at service panel and lock service panel to prevent power from being switched on accidentally. When the service disconnecting means cannot be locked, securely fasten a prominent warning device to the service panel.
3. Installation work and electrical wiring must be done by qualified persons in accordance with all applicable codes and standards, including fire-rated construction.
4. Sufficient air is needed for proper combustion and exhausting of gases through the flue of fuel burning equipment to prevent back drafting. Follow the heating equipment manufacturer's guideline and safety standards as published by the local code authorities.
5. When cutting or drilling into walls or ceilings, be careful not to damage existing electrical wiring and other hidden utilities.
6. To reduce the risk of fire, electric shock and to properly exhaust air, ducted fans must always be vented outdoors. Do not vent exhaust air into spaces within walls, ceilings, attics, crawl spaces, or garages. Do not connect this fan with any solid-state speed control device.
7. Always keep the duct clear to maintain proper airflow for venting.
8. The bottom of the hood **MUST NOT BE LESS** than 28" and at a suggested maximum of 36" above cooktop for best capture of cooking impurities. For a gas range, the bottom of the hood **MUST NOT BE LESS** than 30" above cooktop.

WARNING

- Do not repair or replace any part of this appliance unless specifically recommended in this book. All other service should be performed by a qualified technician.
- The hood motor has a thermal overload that will automatically shut off the motor if it becomes overheated. The motor will restart. If the motor continually shuts off and restarts, contact the Cyclone service department. Ensure that the hood is mounted at the recommended mounting height.
- This product may have sharp edges. Be careful to avoid cuts and abrasions during installation and cleaning.

Contents

Important Safety Instructions.....	3
Damage Inspection.....	5
Ducting.....	5
Mounting Heights and Clearance.....	6
Wiring Installation.....	6
Undermount Installation - Tools and Materials Required.....	7
Undermount Installation - Parts supplied.....	7
Undermount Hood Installation.....	8
PTB8 Series Installation.....	10
Undermount Hoods Specifications.....	12
Troubleshooting.....	13
Maintenance.....	14
Control Panel.....	15
Cyclone Range Hoods Limited Warranty.....	16

DAMAGE INSPECTION

- Please fully inspect unit for damage before installation.
- If the unit is damaged in shipment, return the unit to the store in which it was bought for repair or replacement.
- If the unit is damaged by the customer, repair or replacement is the responsibility of the customer.
- If the unit is damaged by the installer (if other than the customer), repair or replacement must be made by arrangement between customer and installer.
- Once installed, all damages will be assumed the responsibility of the installer.

DUCTING

⚠ WARNING

- To reduce the risk of fire, use only metal ductwork.
- To reduce risk of fire and to properly exhaust air, be sure to duct air outside – do not vent exhaust air into spaces within walls, ceilings, attics, crawl spaces, or garages.

⚠ CAUTION

- Best to use rigid type metal ducts. Flexible ducts can restrict airflow by more than 50%.
- Reduce the number of transitions and turns as much as possible. If a reducer is used, install a long reducer instead of a pancake reducer. If turns and transitions are required, install them as far away from the opening as possible and as far apart between two as possible.

⚠ WARNING

- 450 - 699 CFM requires a minimum of 6" diameter duct.
- 700 - 949 CFM requires a minimum of 8" diameter duct.
- 950 - 1200 CFM requires a minimum of 10" diameter duct. Any use of duct contrary to above, can result in the warranty being rendered null and void.
- The venting duct must travel horizontally or vertically up to the outside wall or the roof. If it is turned downward anywhere in the venting system, the warranty can be rendered null and void.

Fasten all connections with sheet metal screws and tape all joints with certified aluminum foil tape or duct.

Do not cut a joist or stud unless absolutely necessary. If a joist or stud must be cut then a supporting frame must be constructed.

Before making cutouts make sure there is proper clearance within the ceiling or wall for the exhaust vent.

Examples of different types of ventilation for undermounts:

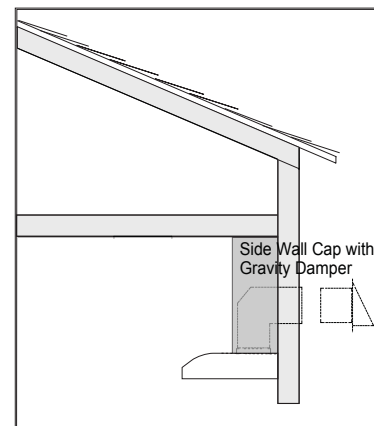
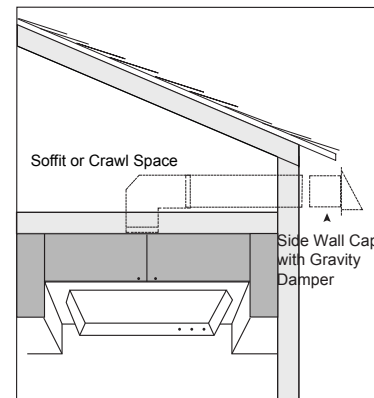
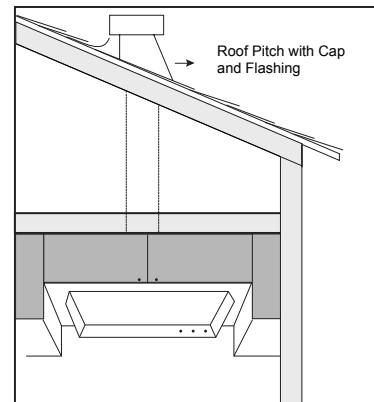

Additional parts not provided.

MOUNTING HEIGHTS AND CLEARANCE

WARNING

- The hood should be installed at 28" minimum above the cooking surface. If pairing your range hood with a gas stove minimum mounting height must be 30" above the cooking surface.

Minimum mount height between range top to hood bottom should be no less than 28" for electric or ceramic stoves, and no less than 30" for gas stoves. The maximum mount height should be no more than 36". The hood must be installed at the correct mounting height. Hoods mounted too low could result in heat damage. Hoods mounted too high, on the other hand, will be less effective and performance may suffer.

Check your ceiling height and the hood height maximum before you select your hood.

Hood installation height above cook top is the user's preference. The lower the hood is above the cook top the more efficient it will be in drawing out cooking odors, grease and smoke.

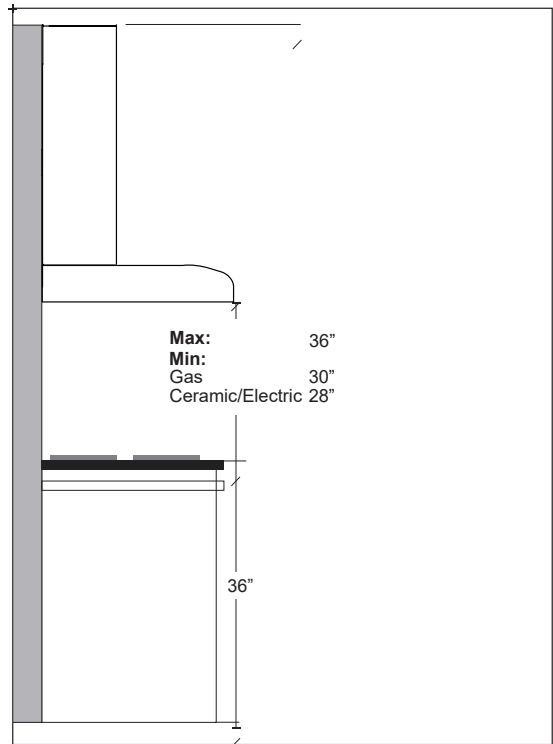

WIRING INSTALLATION

This appliance requires 120V 60Hz electrical supply and connection to an individual properly grounded branch circuit protected by a circuit breaker or time delay fuse.

Grounding Instructions

This appliance must be grounded.

This appliance is equipped with a cord having a grounding wire or with a plug having grounding wire. The grounding wire must be grounded properly in the junction box or the plug must be plugged into an outlet that is properly installed and grounded.

1. Connect the power line ground wire to the green ground wire supplied with the hood.
2. Connect the black power wire to the black wire supplied with the hood.
3. Connect the white neutral wire to the white wire supplied with the hood.

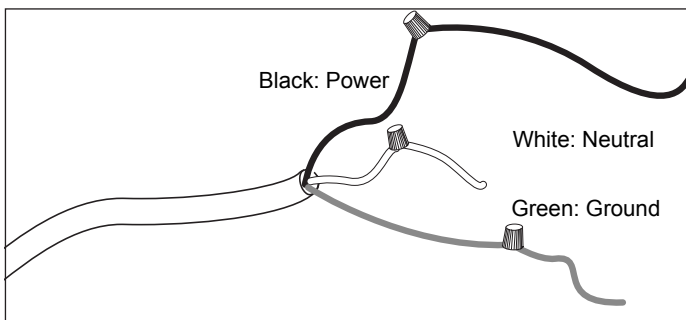

Install the Electrical Power Supply (PTB8 series only)

Position the outlet or junction box within the space covered by the upper cabinet or optional chimney flue. Place the outlet or junction box at a maximum distance of 36" above from where the cord exits from the hood. The center of the outlet or junction box should be positioned at no less than 2 3/4" away from the center of the damper. Make sure this does not interfere with the mounting area, ducting or chimney flue.

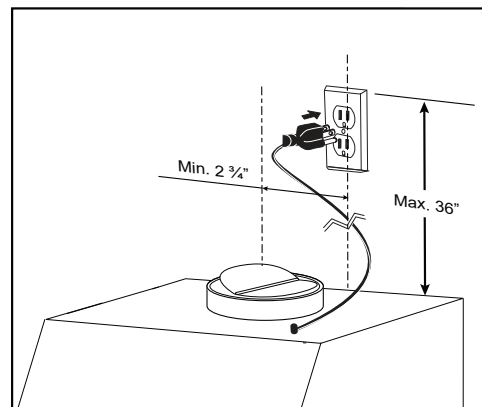

PLEASE REFER TO PAGES 11-20 FOR YOUR MODEL'S SPECIFICATIONS

UNDERMOUNT INSTALLATION - TOOLS AND MATERIALS REQUIRED

- Electrical drill or ratchet driver
- Phillips screwdriver #2 or driver bit
- Straight blade screwdriver
- Wire stripper or cutter
- Tape measure
- Electrical supplies for wiring (i.e. marrets, electrical tape)
- Aluminum foil tape and/or duct tape
- Hammer
- Jigsaw or saber saw
- Step ladder

UNDERMOUNT INSTALLATION - PARTS SUPPLIED

1 × Hood

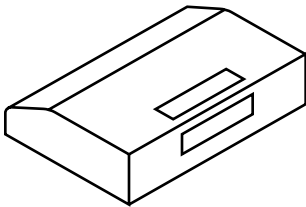

Rectangular Opening Models ONLY:
1 × Rectangular Damper

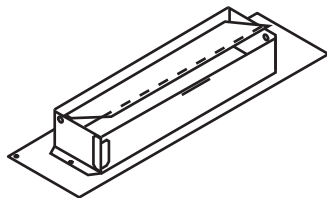

All Units Except NA330R:
2 × Round Oil Saucers
CYS1000R ONLY:
1 × Round Oil Saucer

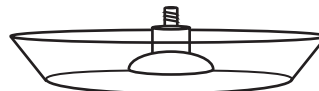

All Units Except NA330R:
2 × Rectangular Oil Cups
CYS1000R ONLY:
1 × Rectangular Oil Cup

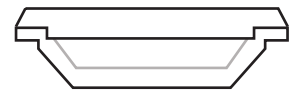

CY3000R ONLY:
2 × Insertable Oil Cups

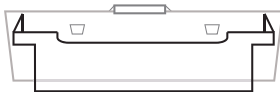

**INCLUDED IN UNIT
CYS1000R, CY1011R:**
2 × Halogen Lights
(20W per bulb)



**INCLUDED IN UNIT
CY3000R ONLY:**
2 × Dimmable LED Lights
(1W per bulb)



**PRE-INSTALLED
NA330R ONLY:**
2 × LED Lights
(1.5W per bulb)
*Bulb & socket may change.

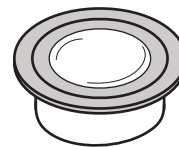

NA330R ONLY:
1 × Oil Collector

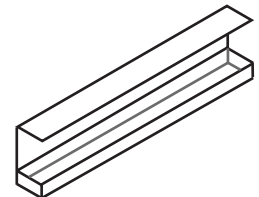

HARDWARE PACKAGE

4 × Mounting Screws

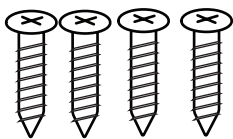

Rectangular Opening Models ONLY:
6 × Damper Screws

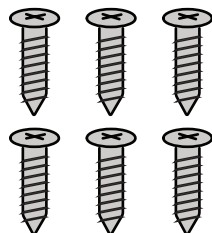

UNDERMOUNT HOOD INSTALLATION

⚠ WARNING

- Turn off power circuit at the service panel before wiring this unit.
- All electrical work must be done by a qualified electrician in accordance with all applicable codes and standards. This range hood must be properly grounded.

⚠ CAUTION

- At least two installers are required due to the weight and size of the hood.

Preparation for Installation

1. Unpack range hood and check contents. Note: Be cautious of sharp edges within the unit. Remove hood cover insert screws and lift off cover to expose the inside (Figure 1). For NA330R/PTB56, to open the cover (baffle filter) complete the following steps (Figure 1a):
 - i. Pull the baffle filter forwards toward the front of the hood using the handle while pushing the back side upwards inside the hood.
 - ii. With the filter tilted upwards, push the filter backward and then pull down the front to remove the baffle filter.

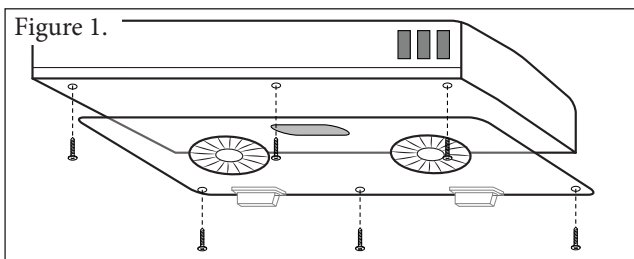

2. Remove either the top or rear electrical knockout depending on how you plan to run power leads to the hood through cabinet or wall (Figure 2).
 - i. Insert a screwdriver into the knockout slot and bend the knockout back and forth (Figure 3a & 3b). Pliers may be used to remove the loosened knockout.
3. For rectangular rear venting configuration (Figure 4):
 - i. Cover the rectangular top cutout with the rectangular cover plate and fasten with tapping screws. For optimal use, remove flapper for top venting configuration.
 - ii. Place the rectangular damper onto the rear cutout and fasten with tapping screws.

Important: Seal both the top cover plate and damper with aluminum foil tape (preferred) or duct tape.

4. For rectangular top venting configuration (Figure 5):
 - i. Cover the rear cutout with the rectangular cover plate and fasten with tapping screws.
 - ii. Place the rectangular damper onto the top rectangular cutout and fasten with tapping screws.

Important: Seal both the rear cover plate and damper with aluminum foil tape (preferred) or duct tape.

5. For round top venting configuration: no rear cover or damper required.

Baffle Removal for NA330R/PTB56:

Figure 1a.

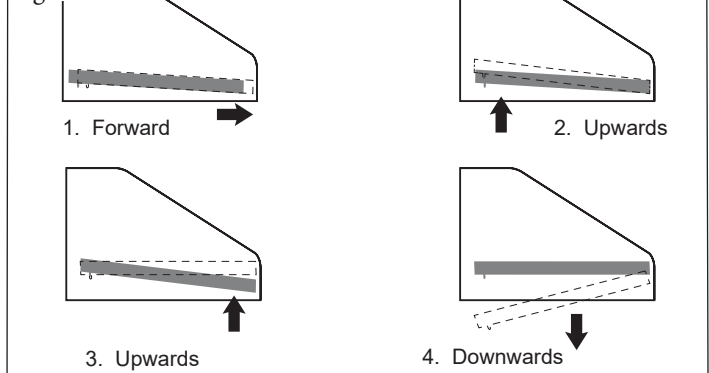

Figure 2.

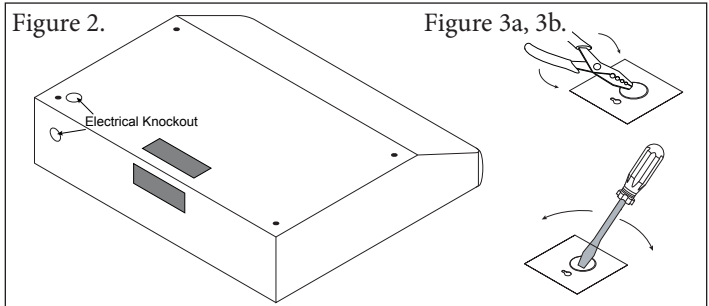

Figure 3a, 3b.

Figure 4.

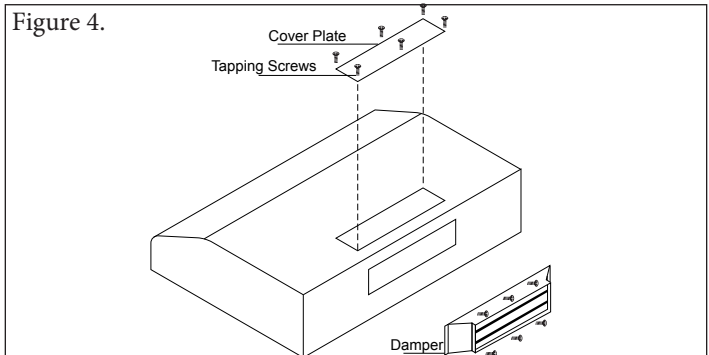
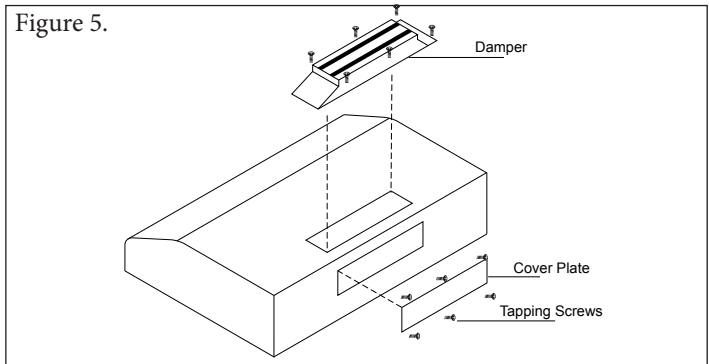

Figure 5.



Preparation for Vent and Exhaust Duct Connection

- To connect a rectangular vent to a round exhaust duct (or vice versa), you must use a transition and/or adapter.
- If the duct size is greater than what is equipped on the product, a reducer is necessary to accommodate the different size. If the duct size is less than what is recommended for your product, the efficiency of your Cyclone Range Hood will be reduced and the warranty can be rendered null and void.
- If the rectangular vent is being connected to an existing rectangular duct, a transition/adapter may not be required, however, a professional should be consulted to install the range hood properly.
- An exhaust duct needs to be cut if there is not an existing duct in your home. Please consult/hire a professional to complete the work properly. In general, for rear venting, a rectangular hole needs to be cut into the wall to fit the rectangular exhaust duct extended to the outside wall. For top venting, a rectangular or a 6" round hole needs to be cut through the ceiling or the back wall and the bottom of the cabinet to fit the duct connection.

Install the Undermount Hood

- Place the range hood on the bottom of the cabinet. Route the power supply cord through the access hole and through the knockout. This step will have to be accomplished while positioning the hood (Figure 6 & 7).
- Center the hood in place beneath the cabinet and flush with the front of the cabinet. Outline the four keyhole mounting slots for the hood onto the bottom of the cabinet.
- Partially screw in the four hood mounting wood screws through the narrow ends of the marked keyholes.
- Align the hood's wider ends of the keyholes mounting slots over the four partially installed screws. Push the hood against the wall so that the screws are now secured in the narrow end of the keyhole and that the front of the hood is aligned with the cabinet front (Figure 7).
- Check to ensure the rear or top vent is fitted and connected to the duct properly. Use aluminum foil tape to cover all seams.
- Tighten the hood mounting screws all the way into the cabinet so the hood is firmly attached.
- Make the Electrical Connection
 - Secure the electrical wire to the hood with the connector's "STAR" locknut.
 - Strip about ½" of insulation from the ends of the electrical power wires.
 - Connect the power line ground wire to the green ground wire supplied with the hood (Figure 8).
 - Connect the black power wire to the black wire supplied with the hood.
 - Complete the same step with the white wire.
- Reinstall the hood cover plate with the insert screws. For NA330R, no screws are needed. Place baffle filters back on.
- Attach the rectangular and round oil collectors at the far back and under the fan guard respectively. For NA330R, oil collector is already installed.
- Turn on the hood to check for any leaks in the ductwork and to ensure proper function.

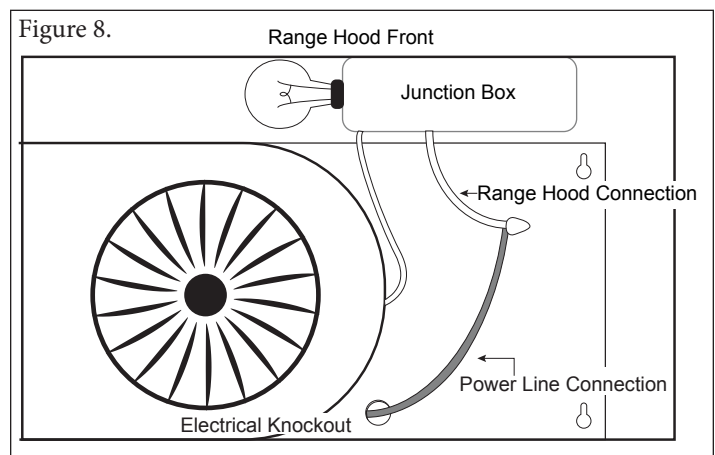
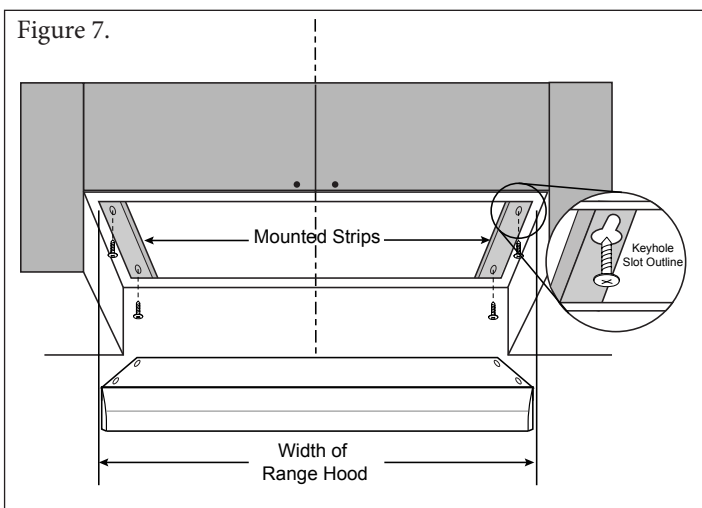
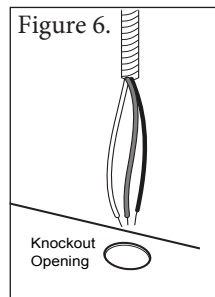

PTB8 SERIES INSTALLATION

⚠ WARNING

- Turn off power circuit at the service panel before wiring this unit.
- All electrical work must be done by a qualified electrician in accordance with all applicable codes and standards. This range hood must be properly grounded.

Preparation for Installation

1. Unpack range hood and check contents. Please inspect the product for damage and/or defects prior to installation. Note: Be cautious of sharp edges within the unit.
2. Confirm that all hardware and accessories are present in addition to the range hood;
 - 1 - Package containing
 - ◆ 5 x - $\frac{5}{8}$ " wood screws for securing the top of the hood to upper cabinet (if applicable)
 - ◆ 4 x - 3" wood screws for securing the cleat
 - ◆ 4 x - $1\frac{1}{8}$ " wood screws for securing the hood to the cleat
 - ◆ 6 x - $\frac{5}{8}$ " screws for securing the damper
 - ◆ 1 x - rubber damper seal/gasket
 - ◆ 2 x - wall anchor
 - ◆ 2 x - $1\frac{1}{4}$ " screws for anchors
 - 2 - Baffle filters (for 30" model, 3 filters for 36" model)
 - 1 - Grease cup
 - 1 - Wood mounting cleat (strip) - 28.5" x 2" x $\frac{3}{4}$ "
 - 1 - Damper

⚠ CAUTION

- At least two installers are required due to the weight and size of the hood.

Preparation for Vent and Exhaust Duct Connection

1. The round vent of a Cyclone Range Hood is 6" (8" for PTB88). If the round exhaust duct is not 6" (8" for PTB88) diameter, a transition/adaptor is necessary to accommodate the different size. If the exhaust duct is less than 6" (8" for PTB88) diameter, the efficiency of your Cyclone Range Hood will be reduced and the warranty may be rendered null and void.

Wall Mount Installation Instructions

1. Determine mounting height of the hood. Cyclone recommends that the hood be mounted at a minimum height of:
 - ◆ For gas stoves 30" - 36"
 - ◆ For electric, induction, etc. stoves 28" - 36"
2. Confirm the location of the mounting cleat and check to make sure it is centered and level. Secure the cleat in place with the 3" wood screws provided. (Figure 1)

Note: make sure the wood cleat is secured and fastened to all available wall studs (a minimum of 2 studs is ideal) where there is only one stud available, use drywall anchors or suitable substitute.

Do not rely on drywall alone to support the hood.

Figure 1

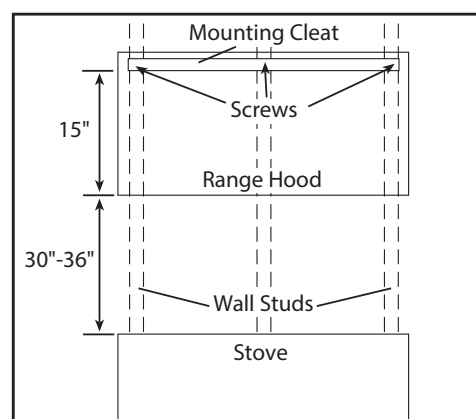

3. Rest the hood on the wood cleat with one person holding the hood. Score the drywall through at least 2 of the 3 holes located on the rear panel of the hood for placement of screws and/or drywall and anchors. Remove the hood and drill pilot holes into the marks transferred on the wall and add anchors if there is no stud(s) available.

Figure 2

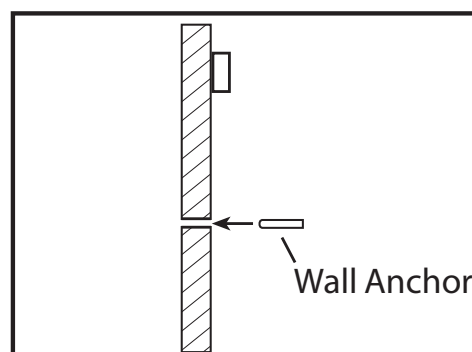

4. Install the plastic damper using the rubber seal and the 6 x 5/8" screws provided. (Figure 3)

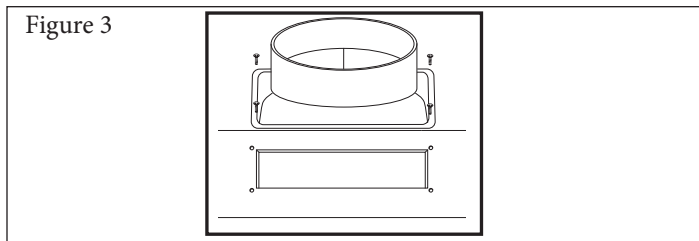

5. Once anchors are installed, secure the hood to the wood cleat using the 1 1/8" screws provided. Use the 1 1/4" screws to secure the back panel of the hood to the anchors in the wall. (Figure 4)

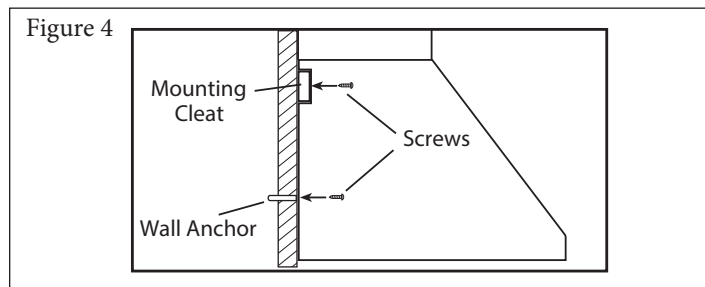

Under Mount Installation Instructions

***FOLLOW THE STEPS FOR WALL MOUNT INSTALLATION**

In Addition:

1. Cut an access hole in your cabinet for the damper and ducting. Note: The damper should be installed at the end when connecting the duct. (Figure 5)

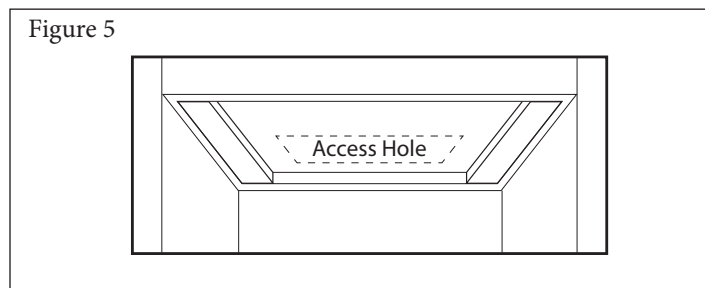

2. There are 5 pilot holes located at the top of the hood. Use the 5 x 5/8" screws provided to secure the hood to the cabinet. (Figure 6)

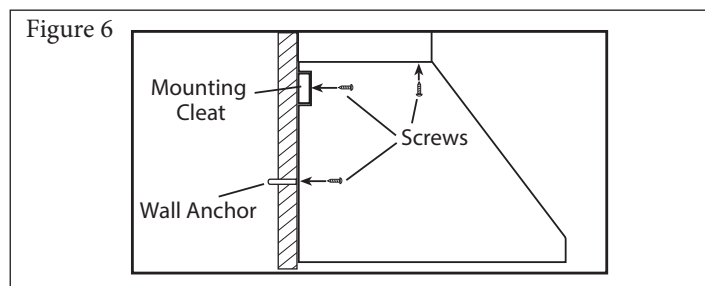

UNDERMOUNT HOODS SPECIFICATIONS

	NA940D	CY917R	CYB919R	CYS1000R	NA330R	PTB8 Series	PTB56
SIZE	30"	30"/36"	30"/36"	24"/30"	30"/36"	24" (PTB83) 30"/36" (PTB83/86/88)	30"/36"
MAX. CUBIC FEET/ METER (CFM)	680	300	570	300	680	300 (PTB83) 600 (PTB86) 880 (PTB88)	680
MAX. SONES	7	4	7	4	7	4 (PTB83) 6 (PTB86) TBD (PTB88)	7
MOTOR	DOUBLE	SINGLE	DOUBLE	SINGLE	DOUBLE	SINGLE	DOUBLE
FINISH	WHT/BLK/SS	WHT/BLK/SS	WHT/BLK/SS	WHT/BLK/SS	SS	SS	MB/SS
CONTROLS	ROCKER SWITCH	PUSH BUTTON	PUSH BUTTON	ROCKER SWITCH	DIGITAL TOUCH SWITCH	PUSH BUTTON	PUSH BUTTON
SPEED LEVELS	2	3	3	2	6	3	4
TIME DELAY OFF	NO	NO	NO	NO	YES	YES	YES
FILTERS	NO	MESH	BAFFLE	NO	BAFFLE	BAFFLE	BAFFLE
DUCT	NA940D - 6" ROUND TOP/ 3 1/4" x 10" RECTANGULAR TOP OR REAR	3 1/4" x 10" RECTANGULAR TOP OR REAR	3 1/4" x 10" RECTANGULAR TOP OR REAR	3 1/4" x 10" RECTANGULAR TOP OR REAR	3 1/4" x 10" RECTANGULAR TOP OR REAR	PTB83/PTB86 - 6" ROUND TOP/ PTB88 - 8" ROUND TOP	3 1/4" x 10" RECTANGULAR TOP OR REAR
LIGHTING	Florescent	2 x 1.4W LED Light Bulb	2 x 1.4W LED Light Bulb	2 x 20W Halogen Lights	2 x 1.4W LED Puck Light	3 x 1.4W LED Puck Light	2 x 1.4W LED Puck Light
AC INPUT	120V 60Hz	120V 60Hz	120V 60Hz	120V 60Hz	120V 60Hz	120V 60Hz	120V 60Hz
MOUNTING HEIGHT	Min. Electric 28" Gas 30" Max. 36"	Min. Electric 28" Gas 30" Max. 36"	Min. Electric 28" Gas 30" Max. 36"	Min. Electric 28" Gas 30" Max. 36"	Min. Electric 28" Gas 30" Max. 36"	Min. Electric 28" Gas 30" Max. 36"	Min. Electric 28" Gas 30" Max. 36"

*Bulb & socket may change.

TROUBLESHOOTING

For additional service inquiries, contact Cyclone servicing department at 1-888-293-5662 or Service@CycloneRangeHoods.com

ISSUE	CAUSE	SOLUTION
Unit doesn't work after installation.	1. The power source is not turned ON.	1. Ensure power is ON for the circuit breaker and unit.
	2. The power line and the cable locking connector are not connected properly.	2. Check the power connection with the unit is connected properly.
	3. The control panel or motherboard is defective (CY3000R/NA330R).	3. Change the control panel or motherboard.
Light indicates power ON but motor doesn't turn.	1. The motor is defective, possibly seized.	1. Change the motor. Servicing may be required.
	2. The control panel or motherboard is defective.	2. Change defective part. Servicing may be required.
The unit vibrates.	1. The motor is not secured.	1. Tighten the motor in place.
	2. Damaged blower wheel.	2. Replace the blower wheel. Servicing may be required.
	3. The hood is not secured in place.	3. Check the installation of the hood. Screws may require tightening
	4. Venting duct too small or blockage in the duct opening or ductwork.	4. Check the venting duct and the wall cap or roof cap.
Motor works but lights do not turn on.	1. Defective light bulb.	1. Change the light bulb.
	2. The light bulb is loose.	2. Tighten the light bulb.
	3. The control panel or motherboard is defective (CY3000R/NA330R).	3. Change the control panel or motherboard.
The hood is not venting out properly.	1. The hood might be hanging too high from the cook top.	1. Adjust the distance between the cook top and the bottom of the hood within 28" - 36" above the range.
	2. Blockage in the duct opening or ductwork.	2. Remove all obstructions from the duct work or duct opening.
	3. Using the wrong size of ducting.	3. Use the appropriate size duct work.

MAINTENANCE

For a complete description of our maintenance and operating instructions you may visit us online at www.CycloneRangeHoods.com to download your model's Use and Care Guide.

Due to the fact that we are always striving to improve our products and take advantage of advances in technology, there may be slight variations in your product.

WARNING

- Always switch off power and unplug before cleaning and maintenance.

Surface and Filter Cleaning:

Clean with warm soapy water and a clean cloth. Do not use corrosive or abrasive detergent or steel wool pads that can scratch the surface of the machine.

Use non-abrasive stainless steel polish to buff out the luster and grain. Scrub lightly.

The stainless steel filters trap residue and grease from cooking. The filters should never have to be replaced but should be cleaned thoroughly every 30 to 60 days depending on cooking habits. Filters may be placed on the top rack of the dishwasher or soaked in warm, soapy water.

Spray degrease detergent and leave to soak if heavily soiled.

Replacing Lightbulbs:

WARNING

- Always switch off electrical supply before carrying out any operation on the appliance.
- In order to prevent the risk of personal injury, the halogen lamps must be cooled before removal.
- Do not use more than 60W incandescent light bulbs for any model. Do not use round shaped light bulb for models NA940D. Recommended use 23W florescent tube (equivalent to a 90W incandescent light bulb).
- *Bulb & socket may change.

Please use 23W or 15W florescent tube light bulbs for NA940D. Use 120V 20W halogen light bulbs for CY1011R/ CYS1000R. Use LED bulb, 1.4W maximum per bulb, for CY3000R. Use LED puck light, 1.4W maximum per light, for NA330R.

To change bulbs for CYS1000R and CY3000R:

1. Firmly press fingers against the light bulb and twist counter-clockwise until bulb is loosened

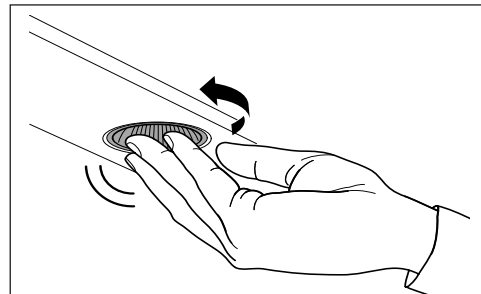

This range hood requires LED bulbs. (1.4W maximum per bulb) To change the light bulb, remove light case from the light socket. The light case can be accessed from the inside of the body of the machine.

- i. Disconnect the connecting wires of the light socket from the motherboard wires.
- ii. Remove grease filters and push light case outward away from the machine.
- iii. Replace with a new case.

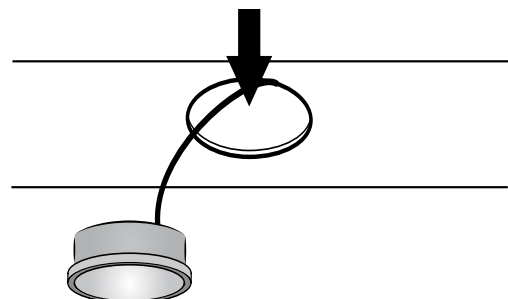

CONTROL PANEL

Model: NA330R (above) CY3000R (below)

The unit is controlled by a digital touch switch.

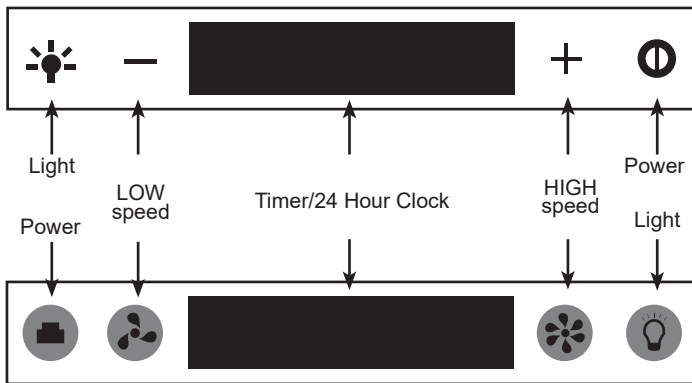

To Set the Time

The time will appear on the digital display panel. Simply press and hold the power button for about three seconds and use the LOW button to set the hour and the HIGH button to set the minutes.

To Engage Time-Delay Off Functions:

Simply press the power button while the machine is running, and use the LOW and HIGH power buttons to set the number of minutes you would like the fan to run before automatically shutting off.

Model: PTB8 Series

The unit is controlled by push buttons

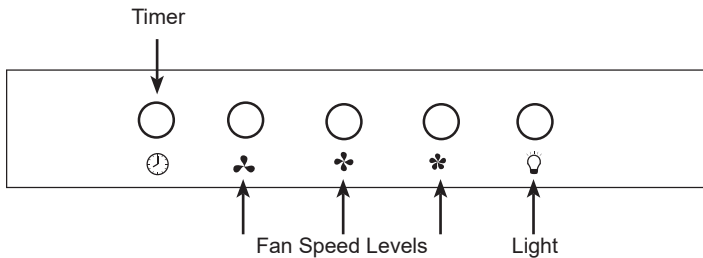

To Engage Time-Delay Off Functions:

Simply press the timer button while the machine is running to engage the timer for three minutes. Press the timer button again, and the fan will turn off.

Model: NA940D/CY1011R

The unit is controlled by rocker switches.

The fan and light are each controlled by a rocker switch. The fan switch has three positions: HIGH, LOW and OFF. The light switch has two positions, ON and OFF. For CY1011R the light switch has three positions for HIGH, LOW and OFF.

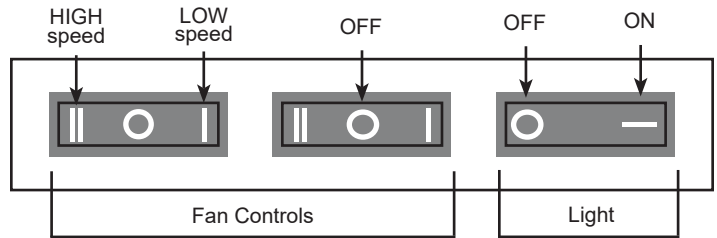

Model: CYS1000R

The unit is controlled by rocker switches.

The fan and light are each controlled by a rocker switch. The fan switch has three positions: HIGH, LOW and OFF. The light switch has three positions for HIGH, LOW and OFF.

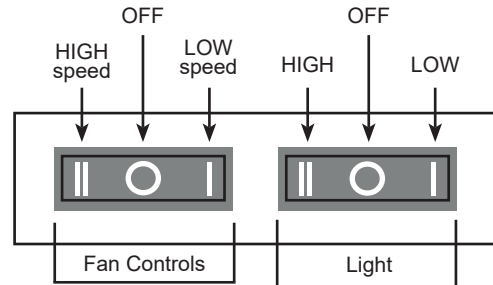

Model: PTB56

The unit is controlled by push buttons

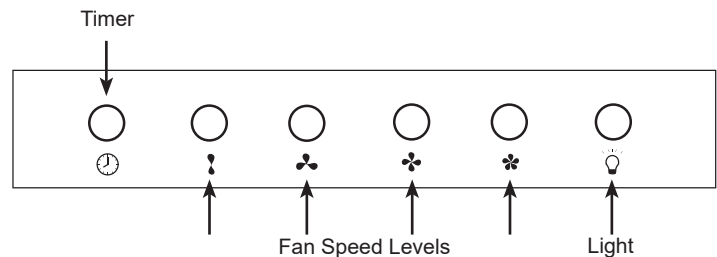

To Engage Time-Delay Off Functions:

Simply press the timer button while the machine is running to engage the timer for three minutes. Press the timer button again, and the fan will turn off.

CYCLONE RANGE HOODS INC. LIMITED WARRANTY - RANGE HOOD PRODUCTS (2022)

Cyclone Range Hoods Inc. (hereunder called "The Company") provides a warranty that its products are free from defects in workmanship and materials for a period of two (2) years from the date of purchase. This warranty includes in-home service (**where applicable**) for the first year and workshop service for the second year. During that time period, The Company will, at the Company's discretion, repair or replace, without charge, any parts or complete unit found to be defective. Further, the warranty for the motor extends for an additional eight (8) years, not including labour costs. The company reserves the right to use functionally equivalent reconditioned parts or products as warranty replacement or as part of warranty service. This warranty is not transferrable from the original purchaser.

UPON RECEIPT, THE PRODUCT SHOULD BE THOROUGHLY INSPECTED PRIOR TO INSTALLATION. CLAIMS FOR COSMETIC ISSUES WILL NOT BE ACCEPTED ONCE THE PRODUCT HAS BEEN INSTALLED.

THE COMPANY WILL NOT BE HELD RESPONSIBLE FOR ANY CLAIMS OVER THE ORIGINAL PURCHASE PRICE OF THE PRODUCT(S) NOR BE LIABLE FOR INCIDENTAL, CONSEQUENTIAL OR SPECIAL DAMAGES ARISING OUT OF OR IN CONNECTION WITH PRODUCT(S) USE OR PERFORMANCE.

Some provinces do not allow the exclusion or limitation of incidental or consequential damages, so the above limitation or exclusion may not apply to you.

*In-home service will be made available only in areas where a contracted service provider offers services. If a customer is outside the service area, additional charges may apply for shipping costs, warranty repair or replacement. **The removal and reinstallation of the product is the sole responsibility of the customer.***

This warranty does not cover any costs related to the product, including but not limited to:

- a) Normal maintenance of the product(s); (i.e., cleaning of all interior and exterior grease laden surfaces, including all removable parts and accessories)
- b) Any and all lighting options which includes but is not limited to; light bulbs, light sockets, light panels, light grilles, and light lenses. All grease collector cups, filters, ducts, roof caps, wall caps and other accessories used for ducting;
- c) Natural wear on the finish of the product(s) and wear caused by improper maintenance or use of corrosive and/or abrasive cleaning materials;
- d) Product(s) or parts which have been subject to freight damage, misuse, negligence, accident, damage due to improper installation or any other circumstances beyond the control of The Company.
- e) Claims for cosmetic defects once the product has been installed;

The warranty will automatically be rendered null and void if any of the following apply:

- a) Commercial use of the product or use otherwise contrary to its intended purpose;
- b) The function of any part or the complete assembly has been modified or repaired by unauthorized person(s);
- c) Improper installation or installation contrary to recommended installation instructions;
- d) The product is installed at **less than 28"** above an **electric cooktop**;
- e) The product is installed at **less than 30"** above a **gas cooktop**;
- f) Product has not been properly vented outside or a ventilation system obstruction exists;
- g) Improper/inadequate sized ductwork has been used anywhere in the venting system;
- h) The venting duct is turned downward anywhere in the venting system;
- i) Improper/inadequate electrical connection for the product contrary to local building codes and/or electrical safety authorities;
- j) The gas cooktop has a total BTU output that exceeds the CFM output of the product when divided by 100 (i.e., 75,000 BTU cooktop paired with a 650 CFM range hood)

To qualify for warranty benefits you must:

- (a) Notify us within the specified timeframe;
- (b) Provide the model number and serial number of the product;
- (c) Accurately describe the nature of any defect with the product or part. **(Photos and/or videos may be requested)**
- (d) Present evidence of your proof of purchase that clearly indicates the model number of the product and the original purchase date.

Should the Company determine that one or more of the warranty exclusions listed above apply or the customer fails to provide the necessary information/documentation to qualify for warranty benefits, the Company has the right to deny warranty coverage and the customer will be responsible for all applicable costs related to servicing the product.

All warranty claims must be submitted in writing to the vendor from which the product was purchased or the address shown below.

For up-to-date warranty information, please visit www.cyclonerangehoods.com

Cyclone Range Hoods Inc.
1361 Huntingwood Drive, Unit 15 & 16, Toronto, ON M1S 3J1
Tel: 1-866-293-5662 or (416) 293-0933 Fax: (416) 293-4793
Email: service@CycloneRangeHoods.com Website: www.CycloneRangeHoods.com