

# 24" Recessed Handle Dishwasher

300 Series – Stainless Steel SHEM53Z35C



**SHEM53Z35C**  
Stainless Steel

Also available in:

White SHEM53Z32C

**The 3rd rack provides the perfect space for silverware and large utensils while its V shape leaves room below for taller items.**

## Features & Benefits

46 dBA: dishwasher runs quietly so your kitchen conversations aren't interrupted.

With PrecisionWash™, intelligent sensors and precision spray arms target every item of every load, so dishes come out sparkling clean every time.

The AquaStop Plus® premium leak protection system contains leaks through a precisely engineered tub and dual sensor system.

Fingerprint Resistant – providing the ultimate exterior protection against fingerprints, dirt, and smudges.

General Properties	
Number of wash cycles	4
Number of options	3
dBA	46
Third rack	Standard 3rd Rack
Rack adjustability	Rackmatic®
Tub material	Stainless Steel
Control type	Buttons
Concealed water heating element	Yes
Leak protection system	24/7 AquaStop® Plus
Water softener	No
Five-level wash	Yes
ChildLock	Yes
Special features	Extra Dry Option, Anti-fingerprint Finish

Efficiency	
Water usage per cycle	3.5
Energy efficiency class	Tier 1
ENERGY STAR® qualified	Yes
Total annual energy consumption (kWh)	269
Total annual water consumption (g)	623.5

Capacity	
Number of place settings	15



Technical Details	
Watts (W)	1440 W
Current (A)	12 Amps
Volts (V)	120 V
Frequency (Hz)	60 Hz
Power cord length - Install length from corner of unit	67" 45"
Minimum water pressure (lb/sin)	14
Length outlet hose (in)	74 3/4"

Dimensions & Weight	
Overall appliance dimensions (HxWxD) (in)	34 1/16" x 23 9/16" x 22 9/16"
Required cutout size (HxWxD) (in)	34 1/8" x 24" x 24"
Adjustable feet	Yes
Net weight (lbs)	86 lbs

Accessories—Optional	
Junction Box	SMZPCJB1UC
Drain Hose Extension Kit	SGZ1010UC
Silverware Basket US Duo	SMZ4000UC
Dishwasher Accessory Kit	SMZ5000
Edge Protector	SMZEP001UC



**Accessories:** To purchase Bosch accessories, cleaners & parts please call 1-800-944-2904 (Mon to Fri 5 am to 6 pm PST, Sat 6 am to 3 pm PST).

**Notes:** All height, width and depth dimensions are shown in inches. BSH reserves the absolute and unrestricted right to change product materials and specifications, at any time, without notice. Consult the product's installation instructions for final dimensional data and other details prior to making cutout.

**Warranties:** Please see Use & Care manual or Bosch website for statement of limited warranty.

**For more information on our entire line of products, go to [www.bosch-home.ca](http://www.bosch-home.ca) or call 1-800-944-2904**

© BSH Home Appliances Corporation. All rights reserved. Bosch is a registered trademark of Robert Bosch GmbH.

# 24" Recessed Handle Dishwasher

300 Series – Stainless Steel SHEM53Z35C



**BOSCH**

Invented for life

## Installation Details

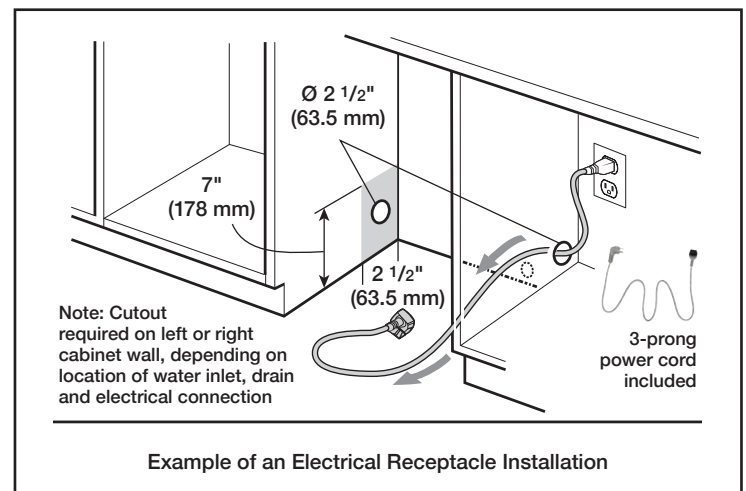
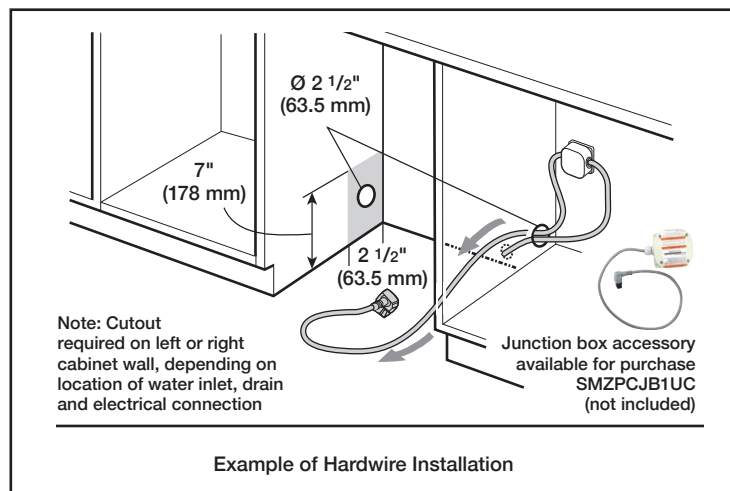
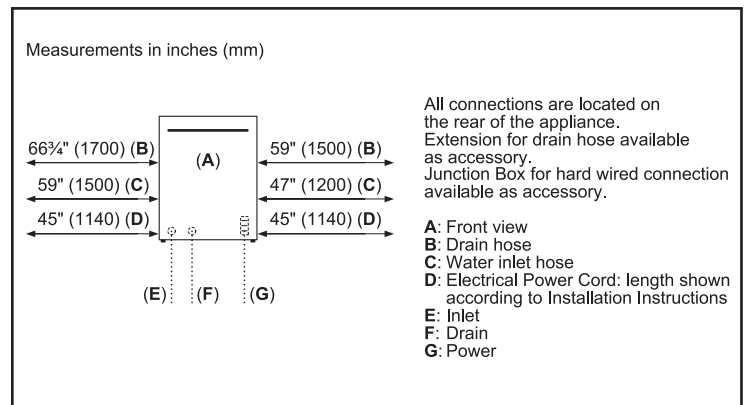
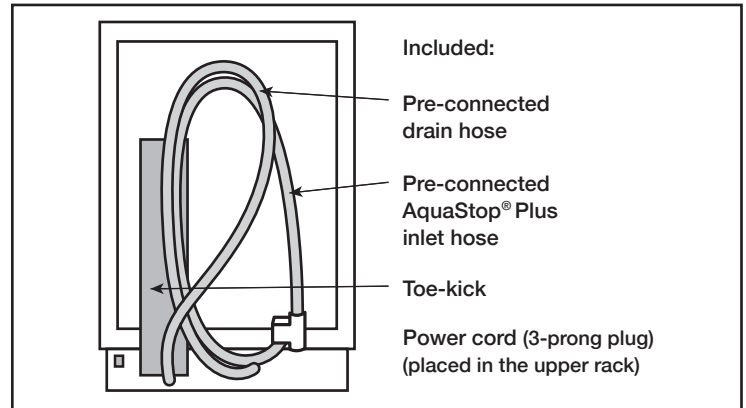
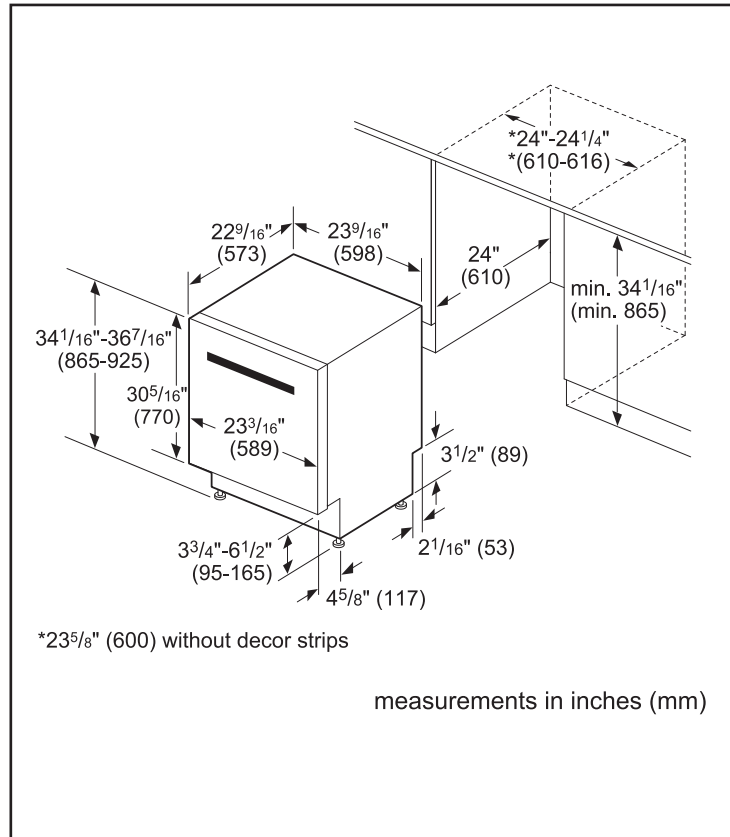

**Accessories:** To purchase Bosch accessories, cleaners & parts please call 1-800-944-2904 (Mon to Fri 5 am to 6 pm PST, Sat 6 am to 3 pm PST).

**Notes:** All height, width and depth dimensions are shown in inches. BSH reserves the absolute and unrestricted right to change product materials and specifications, at any time, without notice. Consult the product's installation instructions for final dimensional data and other details prior to making cutout.

**Warranties:** Please see Use & Care manual or Bosch website for statement of limited warranty.

**For more information on our entire line of products, go to [www.bosch-home.ca](http://www.bosch-home.ca) or call 1-800-944-2904**

© BSH Home Appliances Corporation. All rights reserved. Bosch is a registered trademark of Robert Bosch GmbH.

08/19 CA

# 24" Recessed Handle Dishwasher

300 Series – Stainless Steel SHEM53Z35C



**BOSCH**  
Invented for life



## Installation Details

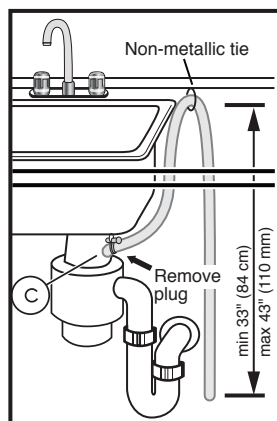
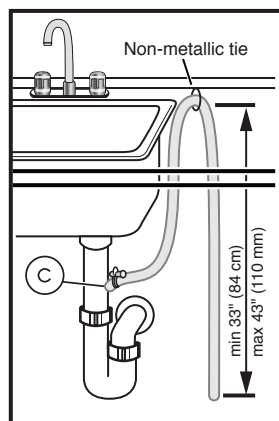

Note: Plumbing installations will vary - refer to local codes. Drain hose included is 75" (190 cm) and can be extended to a maximum of 151" (383 cm).

Always use the approved drain hose extension kit (SGZ1010UC).

Ensure a portion of the drain hose is raised between min. 33" (84 cm) and max. 43" (110 cm) above the cabinet floor.

**Accessories:** To purchase Bosch accessories, cleaners & parts please call 1-800-944-2904 (Mon to Fri 5 am to 6 pm PST, Sat 6 am to 3 pm PST).

**Notes:** All height, width and depth dimensions are shown in inches. BSH reserves the absolute and unrestricted right to change product materials and specifications, at any time, without notice. Consult the product's installation instructions for final dimensional data and other details prior to making cutout.

**Warranties:** Please see Use & Care manual or Bosch website for statement of limited warranty.

**For more information on our entire line of products, go to [www.bosch-home.ca](http://www.bosch-home.ca) or call 1-800-944-2904**

© BSH Home Appliances Corporation. All rights reserved. Bosch is a registered trademark of Robert Bosch GmbH.

08/19 CA