

USE & CARE MANUAL



BLUESTAR[®]

Unleash Your Inner Chef[®]

Freestanding Ranges

RCS (Open/Sealed)

RNB

RPB

Platinum[™]

Precious Metals

750355

BlueStar® Freestanding Range Use & Care Manual MODELS RCS, RPB, RNB, Platinum, Precious Metals

THIS APPLIANCE WAS DESIGNED FOR EASE OF INSTALLATION AND OPERATION. HOWEVER, WE RECOMMEND THAT YOU READ ALL SECTIONS OF THIS MANUAL BEFORE YOU BEGIN INSTALLATION. INSTALLATION MUST BE PERFORMED BY AN APPROVED GAS INSTALLER OR GAS SERVICE TECHNICIAN OR THE WARRANTY IS VOID. **IN THE COMMONWEALTH OF MASSACHUSETTS A LICENSED PLUMBER OR GAS FITTER** CAPABLE OF REVIEWING AND PERFORMING THE MANUFACTURER'S INSTALLATION CHECKLIST SHOULD INSTALL THIS APPLIANCE. THE INSTALLATION CHECKLIST IS INCLUDED AT THE REAR OF THIS BOOKLET.

DO NOT REMOVE PERMANENTLY AFFIXED LABELS, WARNINGS OR DATA PLATES FROM YOUR APPLIANCE. THIS MAY VOID THE MANUFACTURER'S WARRANTY AND/OR HINDER EFFECTIVE SERVICING AND MAINTENANCE.

THESE INSTRUCTIONS ARE TO REMAIN WITH THE APPLIANCE AND THE CONSUMER IS TO RETAIN THEM FOR FUTURE REFERENCE.

WARNING: If the information in this manual is not followed exactly, a fire or explosion may result causing property damage, personal injury or death.

- **Do not store or use gasoline or other flammable vapors and liquids in the vicinity of this or any other appliance.**

- **WHAT TO DO IF YOU SMELL GAS**
 - **Do not try to light any appliance**
 - **Do not touch or activate any electrical switch**
 - **Do not use any phone in your building**
 - **Immediately call your gas supplier from a neighbor's phone. Follow the gas supplier's instructions.**
 - **If you cannot reach your gas supplier, call the fire department**
- **Installation and service must be performed by a qualified installer, service agency or the gas supplier.**

GAS-FIRED



NOTE: WARRANTY SERVICE MUST BE PERFORMED BY AN AUTHORIZED SERVICE AGENT. YOU MAY REQUEST WARRANTY SERVICE BY CALLING 800-449-8691. YOU MAY ALSO REQUEST SERVICE VIA THE INTERNET BY SUBMITTING THE SERVICE REQUEST FORM AT WWW.BLUESTARCOOKING.COM

In the Commonwealth of Massachusetts, gas connections must be performed by a licensed plumber or licensed gas fitter.

Proposition 65 Warning

WARNING AND IMPORTANT SAFETY NOTICE RELATING TO CARBON MONOXIDE: The California Safe Drinking Water and Toxic Enforcement Act requires the Governor of California to publish a list of substances known to the state to cause cancer, birth defects or other reproductive harm, and requires businesses to warn customers of potential exposure to such substances. Carbon Monoxide is one such substance known to the state to cause birth defects or other reproductive harm. Operation of this product could expose you to carbon monoxide if the air shutter are not adjusted properly. Directions on how to adjust the air shutters properly can be found in more detail in the MAINTENANCE section of the Use & Care Manual.

© Copyright 2013 Prizer –Painter Stove Works, Inc. All specifications are subject to change without prior notification

IMPORTANT SAFETY INSTRUCTIONS

SAVE THESE INSTRUCTIONS

Read all instructions before using your appliance. Follow these important safety precautions to reduce the risk of fire, electric shock, personal injury or property damage.

Do not remove permanent labels, warnings or data plates including the serial number from your appliance. Removal may void the manufacturer's warranty and/or hinder effective servicing and maintenance.



If the information in this manual is not followed exactly, a fire or explosion may result causing property damage, personal injury or death.

Do not store gasoline, aerosol cans, sealed containers or any flammable vapors and liquids in the vicinity of this or any other appliance.

Do NOT operate the convection fan during the initial pre-heat of the oven or while broiling.

If You Smell Gas

- Do not try to light any appliance.
- Do not touch or activate any electrical switch.
- Do not use any phone in your building.
- Immediately call your gas supplier from outside your home. Follow the gas supplier's instructions.
- If you cannot reach your gas supplier, call the fire department.

Installation must be performed by an approved gas installer or gas service technician or the warranty is void. In the Commonwealth of Massachusetts a licensed plumber or gas fitter capable of reviewing and performing the manufacturer's installation should install this appliance.



Tipping Hazard

- A child or adult can tip the range over which may cause serious personal injury or death.
- Make sure the anti-tip bracket is securely installed.
- Ensure the anti-tip bracket is engaged when the range is moved.
- Do not operate the range without the anti-tip bracket in place.



GENERAL SAFETY INSTRUCTIONS

SAVE THESE INSTRUCTIONS



- Your appliance should be installed by a qualified gas installation technician. Have the technician show you the exact location of the gas shutoff valve on the incoming gas line so you know how to turn off the gas if necessary.
- Never use this appliance as a space heater to warm a room. Doing so may result in carbon monoxide poisoning and overheating of the oven.
- Do not touch the hot surfaces of the range including the burners, burner grates, cooktop, backguard, oven and oven door interior.
- Before any maintenance or repairs are performed, disconnect the appliance from the electric supply.
- In the event of a power failure, do not attempt to operate the appliance or light any of the burners. This is a gas fired appliance that uses electrical components such as the ignition and safety devices.
- Do not attempt to repair or replace any part of this appliance unless specifically instructed to do so in this manual. In-warranty service must be performed by an authorized service agency.
- Only use this appliance for the intended purposes described in this user manual.
- This appliance should be operated with a properly sized and operational ventilation hood.
- The ventilation and flue ways of this appliance must remain unobstructed at all times.
- Additional care should be exercised if your appliance is equipped with a high-shelf. During heavy or continued use this shelf may become hot. Do not place combustible materials or plastics on this shelf.
- Do not sit, stand, or climb on any part of the appliance including the oven door and cooktop. Serious injury may occur.
- Do not store items of interest to children above the appliance.
- Never leave the appliance unattended during use. Boil-overs may occur, causing spills which may ignite.

IMPORTANT SAFETY INFORMATION

SAVE THESE INSTRUCTIONS



KEEP FLAMMABLE MATERIALS AWAY FROM THE RANGE AND OVEN BURNER

- BlueStar's Platinum™ Series PowR Oven™ uses open flame technology. Flammable materials inside the oven when the oven is in use may ignite.
- Do not store flammable materials on, in or near the appliance. Keep the appliance area clean and free of combustible materials, gasoline and other flammable vapors and liquids, aerosol and sealed containers like baby food jars. Check before each use to make sure that no hazardous materials are in the area.
- Never wear loose fitting clothing or garments with loose sleeves or strings while using this appliance.
- Use care when reaching over the range or into the oven.
- Do not let cooking grease accumulate in or near the range or inside the oven, since it may ignite.
- Clean the grease drip trays and ventilation hood filters frequently to prevent grease build-up.



IN THE EVENT OF FIRE, TAKE THE FOLLOWING STEPS TO PREVENT INJURY AND FIRE SPREADING

- Do not use water on grease fires. Never pick up a flaming pan. Turn off the controls and smother the flaming pan with a fitted lid, cooking sheet or large flat tray.
- If there is a fire in the oven, turn off the oven and keep the oven door closed.
- It is recommended you purchase a multi-purpose dry chemical or foam-type fire extinguisher for your home. Store it in close proximity to your appliance.



COOKTOP SAFETY INSTRUCTIONS

- The push-in and turn control knobs on this appliance are designed to be child-safe, however are not a guarantee of safe operation.
- Do not leave children alone or unattended in the kitchen while the appliance is in use.
- When flaming liquor or other spirits, and if your appliance is installed under a ventilation hood, **TURN THE FAN OFF**. The draft created could cause the flames to spread.
- Turn pot and pan handles inward so they do not extend over adjacent burners or the front of the range to reduce the risk of burns, igniting flammable materials, and spillage.
- After use do not touch the range surface until completely cooled.
- Never leave the surface burners unattended at medium or high heat settings. Foods, especially oily foods, may ignite resulting in fire that could spread to surrounding cabinets.
- Never leave oil unattended while frying. If allowed to heat beyond its smoking point, oil may ignite resulting in fire that may spread to surrounding cabinets. Use a deep fry thermometer whenever possible to monitor oil temperature and operate with safe limits.
- To avoid oil spillover and fire, use a minimum amount of oil when shallow pan-frying and avoid cooking frozen foods with excessive amounts of ice.
- Use proper pan size and avoid pans that are unstable or easily tipped. Select cookware that is matched to the size of the burner. Burner flames should be adjusted so that they do not extend beyond the bottom of the pan. Excessive flames may be hazardous.
- When using glass/ceramic cookware, make sure it is suitable for cooktop service. Some materials may break because of sudden change in temperature.
- Do not use cookie sheets or aluminum foil to cover the grates or line any part of the cooktop. Doing so may result in carbon monoxide build-up and poisoning, over heating the cooktop surfaces, or a potential fire hazard.



OVEN SAFETY INSTRUCTIONS

- Do NOT operate the convection fan during the initial pre-heat of the oven or while broiling.
- The Platinum™ Series oven operates with an OPEN FLAME. Improper use of the oven may result in a FIRE HAZARD. Please review page 28 for more safety instructions.
- Do NOT cover the bottom of the oven floor with aluminum foil or any oven liner.
- Only use dry potholders. Moist or damp potholders on hot surfaces may result in steam burns. Do not allow potholders to touch hot burner areas. Do not use a towel or other bulky material as a potholder.
- Do NOT heat unopened food containers or jarred products like baby food in the oven. The built-up pressure may cause the container to explode.
- Keep the oven door closed at all times when lighting the oven and broiling. Open only to insert or remove food.
- Do NOT cover an entire oven rack with any material such as aluminum foil. It will block airflow throughout the oven and may cause carbon monoxide poisoning. Aluminum foil linings may trap heat, creating a fire hazard.
- Do NOT use a silicone mat on the bottom of the oven. This will block airflow throughout the oven and may cause carbon monoxide poisoning.
- Do NOT place any pot, pan or food directly on the oven floor when baking.
- Do NOT put your face near the infrared broiler.
- Do NOT store food, pots or pans, cooking equipment or containers in the oven when not in use.
- Keep the oven free from grease buildup. Grease in the oven may ignite.

Proposition 65 Warning

WARNING AND IMPORTANT SAFETY NOTICE RELATING TO CARBON MONOXIDE: The California Safe Drinking Water and Toxic Enforcement Act requires the Governor of California to publish a list of substances known to the state to cause cancer, birth defects or other reproductive harm, and requires businesses to warn customers of potential exposure to such substances. Carbon Monoxide is one such substance known to the state to cause birth defects or other reproductive harm. Operation of this product could expose you to carbon monoxide if the air shutter are not adjusted properly. Directions on how to adjust the air shutters properly can be found in more detail in the MAINTENANCE section of the Use & Care Manual.

THANK YOU & WELCOME

Thank you for your purchase and welcome to the BlueStar® Family!

BlueStar® ranges are designed for discerning home chefs who demand restaurant-quality results in their own kitchens. As the owner of a new BlueStar® range you can look forward to years of culinary excellence. You will prepare meals with the speed and accuracy of a professional chef right in your own kitchen. All equipment is designed and manufactured to the highest quality standards in the industry specifically to meet the needs of the world's most demanding chef: you. From simmering to sautéing, baking and broiling these versatile ranges provide the flexibility you need in any cooking application. Please review and familiarize yourself with this Use & Care Guide which includes operating and cleaning instructions as well as tips for getting the most out of your range.

Since 1880, we have been handcrafting the highest quality ranges at our Pennsylvania factory. If your range ever needs attention, please be sure to use a BlueStar® certified service provider recommended by our sales service team. Our service team can be reached at 1-800-449-8691 or serviceteam@bluestarcooking.com. Please take a few moments now to fill in the Service Information on PAGE 8 for your future reference. In the event you require parts or service, this information will be needed to ensure you receive the highest quality service we can provide.

We hope you enjoy your new range,
The BlueStar® Team

PLEASE NOTE: ALL RANGES SHOULD BE INSPECTED UPON ARRIVAL. PER THE WARRANTY ANY COSMETIC ISSUES MUST BE REPORTED TO YOUR DEALER WITHIN 7 DAYS OF DELIVERY. THE PERFORMANCE CHECKLIST MUST BE COMPLETED BY THE CERTIFIED INSTALLER WITHIN 15 DAYS OF INSTALLATION AND SUBMITTED.

SERVICE INFORMATION

Date of Purchase

Model Number

Serial Number

Dealer Name

Dealer Phone

Dealer Address

Date of Installation

Installer Name

Installer Phone

Installer Address

Your installer should complete the Performance Checklist, found in the Installation Manual or page 45 of this manual, before leaving your residence. Mail the completed checklist to: Warranty Department Prizer-Painter Stove Works Inc. 328 June Avenue, Blandon, PA 19510.

NOTE: WARRANTY SERVICE MUST BE PERFORMED BY AN AUTHORIZED SERVICE AGENT. YOU MAY REQUEST WARRANTY SERVICE BY CALLING 800-449-8691. YOU MAY ALSO REQUEST SERVICE VIA THE INTERNET BY SUBMITTING THE SERVICE REQUEST FORM AT WWW.BLUESTARCOOKING.COM

In the Commonwealth of Massachusetts, gas connections must be performed by a licensed plumber or licensed gas fitter.

GETTING STARTED

We know you are excited to start cooking and baking with your new BlueStar® range. Before you begin, it is essential that you follow these steps for safe and optimal use.

- Become familiar with all the parts of your range.
- Remove and properly discard all temporary labels and packaging material from the cooktop, burners, burner grates, oven exterior, oven interior, oven rack glides and oven racks. Remove all: cardboard, zip ties, paper and plastic sheathing used as packaging.

ATTENTION

Do not remove zip ties beneath the burners. These are needed to hold the igniter wires in place.

- Wash all removable parts including ring grates, top grates, oven racks, and oven rack glides in hot, soapy water. Rinse well and dry thoroughly. See the Care and Cleaning section.
- Register your appliance by mailing the Performance Checklist, completed by your installer, and mail to the below address. The Performance Checklist can be found in the Installation Manual or on page **45** of this manual or online at www.bluestarcooking.com/support/product-registration/.

Warranty Department
Prizer-Painter Stove Works Inc.
328 June Avenue
Blandon, PA 19510

ATTENTION

- Perform the Oven Burn-Off procedure before using your oven the first time. The Oven Burn-Off removes all factory oils and residue.
- Season your griddle or French Top before first use
- Do NOT operate the convection fan during the initial pre-heat of the oven or while broiling.

COOKTOP

BURNERS

BEFORE YOU BEGIN

ATTENTION

Each of your burners has a specific BTU (British Thermal Unit) rating. Before disassembly, note the location of each burner. If a burner is replaced in the wrong position it may not function correctly.

Become familiar with the location of your burners. Below are the standard burner configurations.

Platinum Series Ranges: 24", 30", 36", 48" and 60"

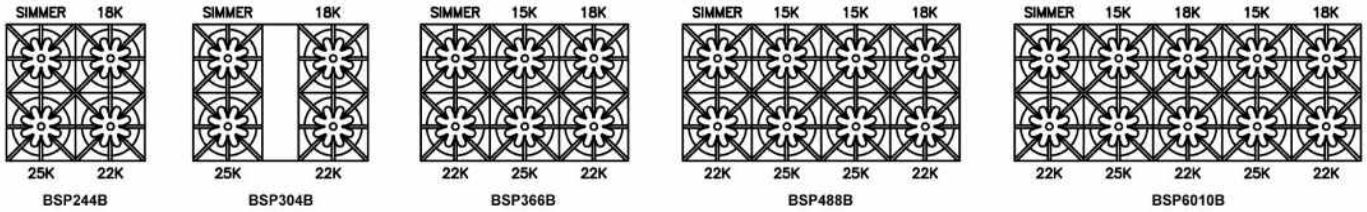

RNB Series Ranges: 24", 30", 36", 48" and 60"

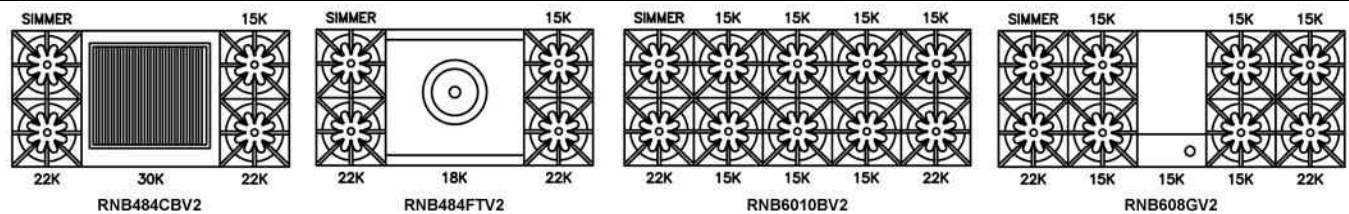
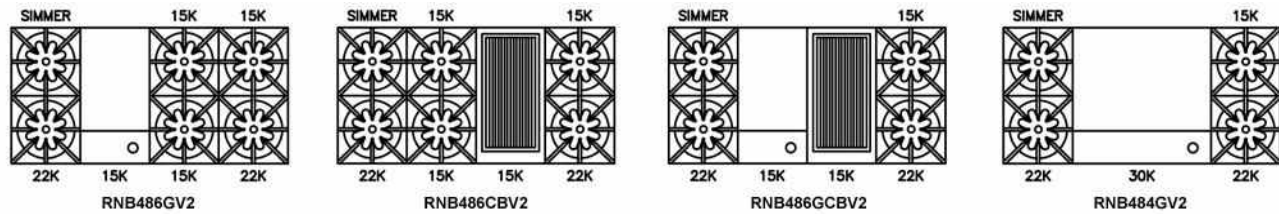
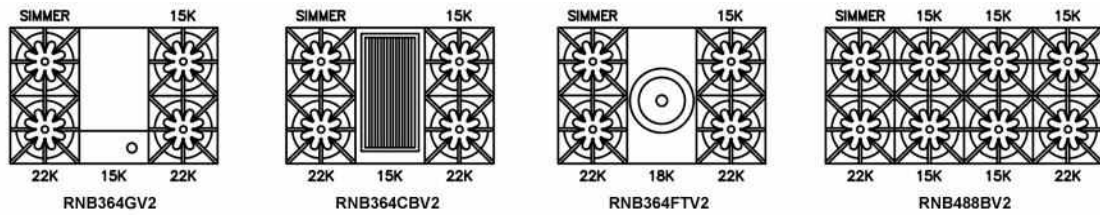
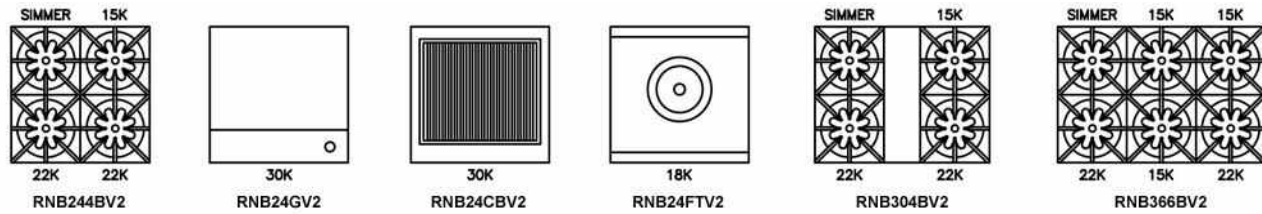

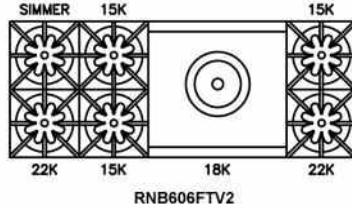
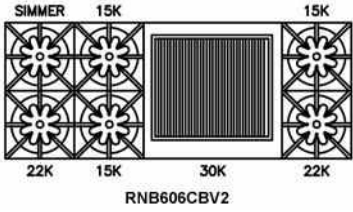
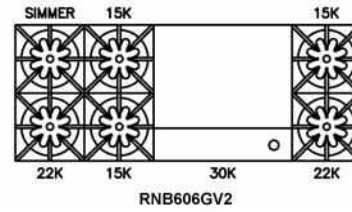
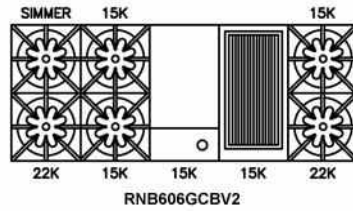
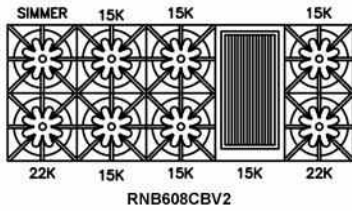

Precious Metals Series Ranges: 30" and 36"

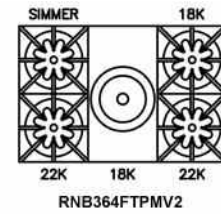
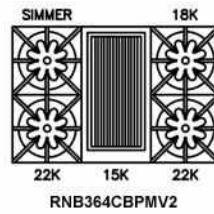
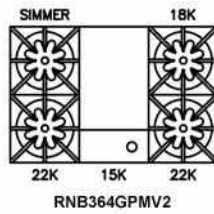
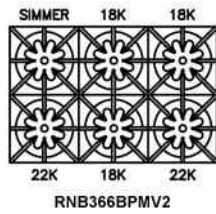
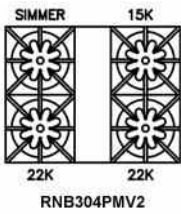

RCS Series Ranges (Open Burner): 30" and 36"

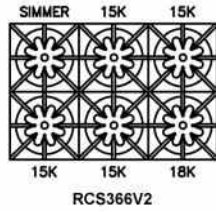
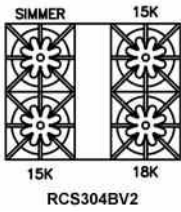

RCS Series Ranges (Sealed Burner): 24", 30" and 36"

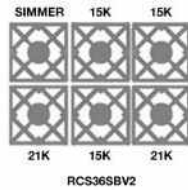
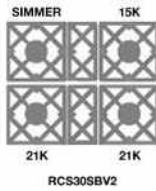
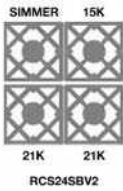

BURNER OPERATION

- Push in and turn the control knob counter clockwise to HIGH to start the ignition process. The igniter will spark and make a clicking sound. The clicking will stop after the burner ignites. The initial ignition may take a few seconds. You may hear multiple clicks before it ignites.
- After ignition, turn the knob to your desired setting.
- Turn the knob to OFF to extinguish the burner. The flame may linger for several seconds until all the gas in the feeder tube is burned off.

ATTENTION

- If the burner does not ignite, see the Before Calling for Service section for possible causes and solutions.
- Burners have a re-ignite feature in case the flame is extinguished for any reason. It may take several seconds for the burner to re-ignite.

CAUTION

Never operate the burner with the knob set between the HIGH and OFF position. The flame will NOT re-ignite in this position and a gas leak could occur.

BURNER SETTINGS

- Burners can be set to any setting between LOW/SIMMER and HIGH.
- The flame should be adjusted to not wrap around the bottom edge of any pot or pan using the knob.

ATTENTION

If the flame is set too high in relation to the edge of the pot or pan, you might scorch the backguard or other areas around your range

Do not leave empty non-stick pans on the French Top as the heat may damage the coating and the French Top surface.

- At the HIGH setting, flames should appear as a defined cone with a dark blue center and light blue outside. Some yellow/orange flame may be seen depending on the type of gas and the supply line.

RING GRATES AND TOP GRATES

OPEN BURNER MODELS TIP: When placing the top grate back on the burner support, locate the sides with the raised edges and ensure they are positioned to the left/right side of the burner. Insert the ring grate into the top grate by aligning the small notch in the top grate with the small indents in the ring grate.

If the top grate is unsteady, remove both the top & ring grates, and adjust the four screws in the corners underneath the top grate accordingly to even out the top grate.

SEALED BURNER MODELS TIP: When placing the top grate back on the cooktop, locate the pin on the bottom of the grate and place inside the positioning holes of the cooktop.

Simmer Burner (some models)

The SIMMER burner gives you a choice of simmer settings from SIMMER to HIGH. The SIMMER setting can be used to gently melt chocolate and hold delicate sauces at low temperatures.

- For the lowest simmer setting, push in and turn the knob to HIGH to ignite the burner, then turn counter clockwise to the SIMMER setting on the knob.
 - For burners without the SIMMER setting marked on the control knob, push in and turn the control knob to HIGH to initially ignite the burner, then turn the knob counterclockwise past the LOW indicator until the knob stops.
- For best simmer results only use the simmer burner. To locate the simmer burner on your range, reference the burner configurations in this manual. The simmer burner is located in the back left position of most ranges.

ATTENTION

Your ring grates, top grates and burner heads may darken over time with use. This is normal.

TIP: To prevent your burners from darkening at an uneven rate, rotate the ring grate and top grates between more and less active burners.

BURNER CLEANING*Ring Grates and Top Grates*

TIP: Clean spills as soon as possible to prevent sticking and build up.

- When burner is cool, remove the ring grate, top grate and center filler grate (30" models only).
- Wash in hot, soapy water. Rinse well and dry thoroughly to prevent rusting.
- Handle gently to prevent nicks/chips, which can lead to rusting

TIP: If you have a nick or chip you can season the area to prevent rusting. Nicks or chips are not covered under warranty.

- Put corn oil or other high smoke point oil on a paper towel and rub onto rusted area.
- Wipe away excess oil and replace the part on the range.

ATTENTION

Do not submerge the burner grates in water for extended periods of time. Prolonged exposure to moisture may cause rusting.

- For heavy soiling, use a commercially available oven cleaner. Follow the cleaner manufacturer's instructions.

CAUTION

Make sure the cleaning chemicals do not contact any stainless steel or painted surface on your appliance.

- Reinstall grates in cooktop and make sure they are seated properly, and do not move unsteadily from side to side.

*Burner Caps (Sealed Burner Models Only)***ATTENTION**

Burner caps locations are specific to the valves on the front of the unit. If burner caps are removed for cleaning or other purposes, they must be re-installed in the same location they were removed from. Failure to do so may result in a burner that will not light or possibly have a high flame.

TIP: Clean spills as soon as possible to prevent sticking and build-up, and to keep the burner ports clear.

- For fresh spills, make sure burner is cool and clean with a cloth and hot water.

*Burner Heads (Open Burner Models Only)***ATTENTION**

Burner head locations are specific to the valves on the front of the unit. If burner heads are removed for cleaning or other purposes, they must be re-installed in the same location they were removed from. Failure to do so may result in a burner that will not light or possibly have a high flame.

TIP: Clean spills as soon as possible to prevent sticking and build-up, and to keep the burner ports clear.

- For fresh spills, make sure burner is cool and clean with a cloth and hot water.

If needed, the burner head can be removed for cleaning:

- When cool, remove the ring grate and top grate.

- Lift the burner head up and slide the burner head unit including the venturi tube up and slightly toward the back of the range so it clears the metal bar.
- Disconnect the orange igniter wire from its connector.
- Gently clean the exterior of the burner head with warm, soapy water. **DO NOT** submerge the burner head in water. Rinse well and dry thoroughly.
- If the burner ports are clogged, use a push pin, safety pin or other metallic device to carefully clear the hole. Do **NOT** use a toothpick or any object that could become stuck in the hole.
- Replace the burner head by sliding the burner head unit underneath the metal bar ; be sure the air shutter of the venturi tube slides over and is centered on the gas valve jet.
- Reconnect the orange igniter wire to the connector.
- Set the burner head in place.
- Replace the top grate and ring grate.

ATTENTION

If the igniter wire is wet, you will hear clicking and the burner will not ignite. Wait and try again. It will light after drying.
 Burner might ignite but clicking may continue until igniter dries.

WOK COOKING

Every burner is wok fitted and can be used for wok cooking without a separate wok ring (open burner units only).

TIP: For best results, use your range's highest BTU rated burner for stir-frying, which are located in the front of the range.

- When burner is cool, remove the ring grate from your selected burner.
- Position your curved-bottom wok on the open burner cradle of the top grate.

INTEGRATED GRIDDLE (SOME MODELS) Before You Begin

You must season your integrated griddle before using. The seasoning process prevents food from sticking and the griddle from rusting. After seasoning, with time and use, your griddle will darken and develop a rich blue/black color, which is normal.



ATTENTION

If you purchased a cast iron griddle separately, do NOT follow the seasoning directions.

Seasoning Your Integrated Griddle

ATTENTION

The complete seasoning process takes approximately 90 minutes and requires attention.

- Remove and discard all temporary factory labels and packaging, including stainless steel griddle cover.
- Wipe off any factory oils and residue with a soft cloth.
- Using a dry cotton towel, apply a light coating of high smoke point oil such as corn oil to the griddle's cooking surface. Smoke point of the oil must be over 450°F.
- Use a different dry cotton towel and wipe away the excess oil.
- Push in and turn the griddle burner control knob counter clockwise to the 300°F setting.
- Allow griddle to preheat for 30 minutes. Note: As the griddle heats, it will likely change color to varying shades of blue/black. This is normal and part of the seasoning process.



WARNING

Griddle is very hot! Use care with next steps to prevent burns. Do not remove griddle from cooktop.

- After 30 minutes at 300°F, use a dry cotton towel and remove the excess oil from the griddle's surface.
- Using a clean, dry cotton towel, apply another coat of corn oil to the griddle's surface.
- Increase the heat setting on the griddle to 325°F. Wait 15 minutes.
- Increase the heat setting on the griddle to 350°F. Wait 15 minutes.
- Increase the heat setting on the griddle to 375°F. Wait 15 minutes.

ATTENTION

Do NOT heat the griddle beyond 375°F during the seasoning process.

- Turn the griddle burner knob to OFF. The griddle is still hot.
- While the griddle is hot, and with extreme care, use a clean, dry cotton towel to remove excess oil.
- Your griddle is now ready for use.
- TIP: If food begins sticking to the griddle over time, repeat the seasoning process as needed.

Integrated Griddle Operation

- Push in and turn the griddle burner knob counter clockwise to the desired temperature setting.
- Allow griddle to pre-heat 20-30 minutes before cooking, for optimal performance.

- Turn off griddle when not in use.
- Do NOT bang the griddle plate with metal utensils as this will damage the griddle surface.
- Avoid gouging the griddle surface.

ATTENTION

Integrated Griddle Cleaning

- Allow griddle to cool to room temperature.
 - Scrape off excess food with a spatula and wipe off used cooking oil.
 - For heavy soiling, use a nylon pad coated with a thin layer of cooking oil.
 - For stubborn stains, you may use a commercially available, FOOD SAFE griddle cleaner. Follow the cleaner manufacturer's instructions for use.
 - After every use, apply a light coating of high smoke point oil like corn oil to the griddle.
 - Wipe off excess using a clean dry cotton towel.
-
- Never flood a hot griddle plate with cold water. This may cause the griddle grate to crack or warp, and will void your warranty.
 - Do NOT use soap directly on griddle surface, residue may remain on the surface of the griddle affecting flavor of food.
 - If you choose to remove and wash your griddle plate in hot, soapy water, you must re-season the griddle using the seasoning process.
 - To prevent rust, do NOT allow your griddle to stand without a fresh coating of oil.
 - Check the grease tray after each use to prevent overflowing.

ATTENTION

CHARBROILER (SOME MODELS)

Before You Begin

Your charbroiler grate is reversible. One side has narrow slats for use with delicate foods like fish and some vegetables. The other side has wider slats for use with larger foods items like steak and chicken. Before igniting the burner, decide which side is best for the dish you are preparing and place that side face up.

CAUTION

Do not light the charbroiler with food on the grates.

Charbroiler Operation



Etching on front control panel to indicate Griddle knob.

- Push in and turn the charbroiler burner control knob counter clockwise to HIGH.
- The hot surface igniter will glow and the burner will ignite.

ATTENTION

The ignition process may take up to three minutes. You might smell gas before the broiler lights. This is normal.

- After ignition, turn the charbroiler control knob to adjust the flame to the desired height.

WARNING

Do NOT put your face or hair near the charbroiler.

Charbroiler Cleaning

- Allow grates to cool to room temperature.
- Remove the porcelain-coated cast iron grates and wash with hot, soapy water and a non-metallic grill brush. Rinse well and dry thoroughly. Do not submerge grates in water for extended periods as this may cause rusting. If charbroiler was submerged, do not use until completely dry. Using immediately after being submerged can damage the surface.
- For heavy soiling, use a commercially available oven cleaner. Follow the cleaner manufacturer's instructions.

CAUTION

Make sure the cleaning chemicals do not contact any stainless steel or painted surface on your appliance.

- Check the grease tray after each use to prevent overflowing.

FRENCH TOP (SOME MODELS)

Before You Begin

You must season your French Top surface before using. The seasoning process prevents the surface from rusting. After seasoning, with time and use, your French Top surface will darken and develop a rich patina color which is normal.

Seasoning your French Top Surface

ATTENTION

The complete seasoning process takes approximately 60 minutes and requires attention.

WARNING

French Top surface is very hot! Use care with next step to prevent burns.

- Remove and discard all temporary factory labels and packaging.
- Remove the two French Top rings from the cooktop.
- Wash the French Top rings in hot, soapy water. Rinse well and dry thoroughly to prevent rusting.
- Leave the French Top frame in place and wipe away all visible oils with warm water and dry with a cotton towel
- Use a dry cotton towel to apply a light coating of high smoke point oil like corn oil to the ring and frame surfaces.
- Use a different dry cotton towel to wipe away the excess oil.
- Insert the French Top sections back into the cooktop, making sure they are seated properly.
- Push in and turn the French Top burner control knob counter clockwise to HIGH. You will hear a clicking sound that will stop when the burner ignites.
- Allow the French Top to preheat for 15 minutes.
- After 15 minutes, turn control knob to LOW. Wait 15 minutes.
- Using extreme care, re-apply high smoke point oil like corn oil with a dry cotton cloth. Wait an additional 30 minutes.
- Turn French Top burner control knob to OFF.
- While griddle is hot, using extreme care, remove excess oil with a dry cotton cloth.
- The French Top is ready for use.

TIP: As the French Top surface heats, it will change color to varying shades of blue and black. This is normal and part of the seasoning process.

TIP: If you see rust spots on the French Top surface, repeat the seasoning process.

French Top Operation

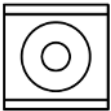

Etching on front control panel to indicate French Top knob.

- Push in and turn the French Top burner knob counter clockwise to HIGH.
- Allow the French Top to pre-heat at least 15 minutes before using. The French Top will change color to different shades of blue and black. This is normal and will permanently change color over time.

WARNING

The French Top's center ring can reach temperatures above 700°F, use extreme caution when operating

CAUTION

- Do not use silicone or plastic utensils on the French Top. They will be damaged when in contact with the hot surface.
- Do not leave non-stick pans on the French Top without food. This may cause damage to the pans.
- Turn the French Top OFF when not in use.
- Your French Top surface is NOT a cooking griddle and is NOT designed for direct contact with food.
- Do NOT cook directly on the steel plates. Always use a pot or pan.
- Do NOT bang the French Top surface with metal utensils or pans as this will damage the surface.
- Avoid gouging the French Top surface.

ATTENTION

French Top Cleaning

- Allow the French Top to cool to room temperature.

- After every use, apply a light coating of corn oil or high smoke point oil. Wipe off excess using a dry cotton towel.
 - Never flood a hot French Top ring or surface with cold water. This may cause the French Top's steel plates to crack or warp, and will void your warranty.
 - If you choose to remove and wash your French Top rings in hot, soapy water, you must re-season the surfaces using the seasoning process.
 - To prevent rust, do NOT allow your French Top to stand without a fresh coating of oil.
 - Check the grease tray after each use to prevent overflowing.

ATTENTION

INTERCHANGEABLE GRIDDLE/CHARBROILER SYSTEM (PLATINUM™ SERIES ONLY)

The Platinum™ Series Griddle/Charbroiler system allows for two-zone cooking, with up to 40,000 BTUs of heat. The cast iron, interchangeable, griddle charbroiler system lets you use the griddle or charbroiler anywhere on the range top. Visit bluestarcooking.com to see the system in action.

The Interchangeable Griddle Charbroiler System comes with 6 pieces.



1. Cast iron frame (skirt) that holds the griddle or charbroiler in place
2. Cast iron, two-sided griddle (flat or ribbed surface)
3. & 4. Pair of cast iron, two-sided (narrow or standard slats) charbroiler grates that are placed side-by-side
5. Stainless steel diffuser (grease diverter), to protect the burners when using the charbroiler
6. Stainless steel cover, for use when the system is kept permanently on the range top



All the pieces of the griddle charbroiler system will be hot during and after use. Use extreme caution while cooking. Make sure the parts are cool before cleaning.

OPERATION

- When the cooktop is cool, remove the ring grates and burner grates from any two, adjacent, front-to-back burners and set aside. Burners must be removed from front to back, not left to right.
- Place the cast iron frame over the two burners, making sure it is seated and level.
 - If using the griddle, select either the flat or ribbed side and insert the griddle plate into the frame.
 - If charbroiling, insert the stainless steel diffuser into the frame with the two sides seated in the frame indents. Select either the narrow or standard slatted side and insert the two broiler grates into the cast iron frame.
- Push in and turn each of the two burner control knobs to HIGH, to ignite the burners, and then turn to the desired heat setting.

TIP – For easier clean-up, add some water to the grease pan underneath the charbroiler before using.

Cleaning

- Allow all parts to come to room temperature.
- For the cast iron frame, griddle, and charbroiler racks, wash with hot, soapy water and a non-metallic grill brush. Rinse well and dry thoroughly.
- Do not submerge grates in water for extended periods as this may cause rusting.
- For the stainless steel diffuser, wash with hot, soapy water. Rinse and dry thoroughly. The stainless steel diffuser is dishwasher safe.

Platinum Series Griddle Plate Temperature Control

Using the 15,000 BTU/25,000 BTU and the 18,000/22,000 BTU burners

- To achieve a 350 degree cooking surface. Turn both burners to the high position for 2 minutes, then turn both burners to the low position for 7 to 10 minutes. This will create an even 350 degree cooking surface.
- To achieve a 400 degree cooking surface. Turn both burners to the high position for 3 1/2 minutes, then turn both burners to the low position for 7 to 10 minutes. This will create an even 400 degree cooking surface.

- To achieve a 500 degree cooking surface. Turn both burners to the high position for 6 minutes, then turn the 25,000 BTU burner to the low position and the 15,000 BTU burner to the medium position for 7 to 10 minutes. This will achieve an even 500 degree cooking surface.

Using the Simmer and the 25,000 or 22,000 BTU burners

- To achieve a 350 degree cooking surface. Turn both burners to the high position for 3 1/2 minutes, then turn both burners to the low position for 10 to 12 minutes. This will create an even 350 degree cooking surface.
- To achieve a 400 degree cooking surface. Turn both burners to the high position for 5 1/2 minutes, then turn both burners to the low position for 10 to 12 minutes. This will create an even 400 degree cooking surface.
- To achieve a 500 degree cooking surface. Turn both burners to the high position for 8 minutes, then turn the 25,000 BTU burner to the low position and the simmer burner to the medium position for 10 to 12 minutes. This will achieve an even 500 degree cooking surface.

Platinum Series Charbroiler Temperature Control

Using the 15,000 BTU/25,000 BTU and the 18,000/22,000 BTU burners

- To achieve a 350 degree cooking surface. Turn both burners to the high position for 9 minutes, then turn both burners to the medium position for 7 to 10 minutes. This will create an even 350 degree cooking surface.
- To achieve a 400 degree cooking surface. Turn both burners to the high position for 11 minutes, then turn both burners to the medium position for 9 to 11 minutes. This will create an even 400 degree cooking surface.
- To achieve a 500 degree cooking surface. Turn both burners to the high position for 15 minutes, then turn the 22,000 BTU or 25,000 BTU burner to the medium position and keep the 15,000 BTU burner to the high position for 13 to 15 minutes. This will achieve an even 500 degree cooking surface.

Using the Simmer and the 25,000 or 22,000 BTU burners

- To achieve a 350 degree cooking surface. Turn both burners to the high position for 12 minutes, then while keeping the simmer burner on high, turn the 25,000 BTU burner to the medium position for 10 to 12 minutes. This will create an even 350 degree cooking surface.
- To achieve a 400 degree cooking surface. Turn both burners to the high position for 20 minutes. This will create an even 400 degree cooking surface. This is the maximum temperature you can achieve using the combination of 25,000 or 22,000 BTU and simmer burners.

OPERATING THE OVEN

BEFORE YOU BEGIN – ALL MODELS

Clean removable oven parts

- As part of installation protective plastic wrappers on stainless steel surfaces should be removed. These wrappers must be removed before operation. Remove and properly discard all temporary labels and packaging material including cardboard, zip ties, paper and wrapping from the oven, broiler pan, oven racks, oven rack glides and exterior surfaces. Remove protective plastic wrap from any stainless steel surfaces.

ATTENTION

Do not remove zip ties located beneath the burners. These are needed to hold the igniter wires in place.

- BEFORE turning on your oven for the first time, remove and wash oven racks and rack glides in hot, soapy water. Rinse well and dry thoroughly. See the Care and Cleaning guide for more details.
- Set glides, and racks aside until the Oven Burn-Off procedure is complete. Do NOT operate the convection fan during the initial pre-heat of the oven or while broiling.

Oven Burn-Off Procedure

The entire Burn-Off Procedure takes about 100 minutes.

ATTENTION

New appliances are wiped clean with solvents at the factory prior to shipping. The Burn-Off procedure burns off any remaining processing residue.

CAUTION

Failing to perform the Oven Burn-Off procedure before first use may result in undesirable odors, flavors, and excessive smoke when you use your oven the first time.

- Make sure your appliance has been installed properly and all performance checks and adjustments are completed.
- Turn on ventilation hood and make sure entire room is well-ventilated.
- Check that the oven cavity is empty. Oven racks and guides or grease pans should NOT be in the oven.
- Push in and turn the oven control knob counter clockwise to 300°. The blue oven indicator light will illuminate. The blue indicator light will cycle on and off as the oven reaches and maintains the set temperature.
- AFTER the blue indicator light turns off for the first time, turn on the convection fan. Wait 30 minutes.
- Increase the oven temperature setting to 450°. Wait 60 minutes.
- After 60 minutes, turn off the oven by turning the control knob clockwise to OFF position.
- Allow oven to cool completely.
- Insert oven rack guides and racks.
- Your oven is now ready for use.

You may notice the following events during the Oven Burn-Off procedure. All are normal.

ATTENTION

- Strong odor
- Some smoke
- Condensation on the front of the range including the oven door, oven window, control panel and side panel.

WARNING

- Your oven is not a storage compartment. Do NOT place food, pots or pans, cooking equipment or storage containers in the oven when not in use.

Oven Guides and Racks

Your oven has two standard racks and two five-position rack guides. Follow your recipe guidelines to determine the best rack location for your dish.

TIP: For best results, center baking pans on the rack this will allow maximum air circulation around the food.



- Always use an oven rack. Never place any food, pot, pan or tray directly on the oven floor.

Extension Rack (RNB & Platinum™ models only)

The RNB range comes with a rack that can be pulled out fully from the oven, making it easy to handle heavy items. Although the full extension rack comes installed at the lowest position, it can be moved to any position.

Extension Rack Operation

Make sure oven is cool and rack is fully inserted into oven cavity.

To Remove

- Grasp the front of the rack and lift up slightly.
- Pull the rack towards you, until completely removed from oven cavity.

To Insert

- Grasp the slides of the rack, making sure that the slides are not extended. If extended, they can be closed by standing the back end of the rack on the floor.
- With the front end of the rack angled up, insert the top tab over the rack guide position you want to use. Tilt the rack down slightly so the bottom tab slides under the guide bar.
- Slide rack evenly into oven cavity.
- Once almost completely in the oven, secure the two tabs at the front of the extension rack in place by placing the rack guide in between
- When fully inserted, secure the rack in place using the tab at the front of each slide.

OVEN RACKS AND GUIDES CLEANING

- Make sure oven is cool.
- Remove oven racks and guides.
- Wash in hot, soapy water. Rinse and dry thoroughly.
- Oven racks and guides are dishwasher safe.

Operating the Oven

WARNING

- Do NOT operate the convection fan during the initial pre-heat of the oven or while broiling.
- Do NOT cover any slots, holes or passages on the bottom of the oven.
- Do NOT cover an entire oven rack with any material such as aluminum foil.
- Do NOT use a silicone mat on the oven floor.

Foil and silicone mats will block airflow into the oven and may cause carbon monoxide poisoning. Aluminum foil linings may trap heat, creating a fire hazard.

- Push in and turn the oven control knob counter clockwise to any temperature setting between 150° and 500°F. The blue oven indicator light will illuminate indicating the oven is on and preheating.

ATTENTION

Although the oven is on, it may take up to three minutes for the oven burner to ignite. This is normal.

- In about 10 minutes, the blue oven indicator light will turn off, indicating the oven sensor has reached the desired temperature. However, it will take up to 30 minutes for the oven cavity to be fully preheated at that temperature.
- The blue indicator light will turn on and off as the oven cycles to maintain the set temperature.

ATTENTION

For best results, do not place your food into the oven until it is fully saturated at the desired temperature.

You may observe the following during the pre-heating process. All are normal.

ATTENTION

- Condensation on the front of the range including the oven door, oven window, control panel and side panel. It will disappear as the oven heats.
- Popping sounds as the metal in the oven expands.

Convection Baking and Roasting

Convection baking and roasting uses a fan inside the oven to circulate the heated air more evenly, resulting in better heat distribution and a more consistent front to back, side to side, and top to bottom temperature.

In general, convection baking or roasting takes less time and at lower temperatures than traditional baking or roasting.

TIP

For best results when convection baking

- Reduce the recommended temperature by 25°F to 50°F.
- Reduce the recommended cooking time.
- Closely monitor the first batch of each new recipe.
- Keep a record of temperature, time and weight for each recipe. Adjust accordingly for the next batch.
- Place baking dishes at the center of racks for maximum air flow, allowing at least 1" between pans.
- Select a baking dish that has no or low sides like a broiler pan so that the air can circulate freely around the food.
- Covered dishes do not benefit from Convection Baking or Roasting.

WARNING

Do not use the Convection Fan during initial preheat or while broiling.

Operating the Convection Fan



Convection Fan Switch

- Push in and turn the oven control knob counter clockwise to any temperature setting between 150° and 500°F. The blue oven indicator light will illuminate, indicating the oven is on and preheating.

WARNING

Although the oven is on, it may take up to three minutes for the oven burner to ignite. This is normal. Do not use the Convection Fan during the initial preheat cycle. Wait until the blue indicator light turns off, signaling the oven has reached the desired set temperature before turning the convection fan on.

- In about 10 minutes, the blue oven indicator light will turn off, indicating the oven sensor has reached the desired temperature. It will take up to 30 minutes for the oven cavity to be fully preheated at that temperature. The blue indicator light will turn on and off as the oven cycles to maintain the set temperature.
- Turn the Convection Fan switch, located on the front control panel, to ON after the oven has pre-heated and the blue oven indicator light has turned off. The convection fan can be turned on or off as desired from this point.

ATTENTION

For best results, do not place your food into the oven until it is fully preheated at the desired temperature.

CAUTION

After every use, after the oven is cooled, check the Convection Fan guard to make sure it is not obstructed. Remove any food particles or obstructions like aluminum foil.

Operating the PowR Oven™ (Platinum™ Series Only)

BlueStar's Platinum™ Series PowR Oven™ uses an **open flame** heating element, which provides faster pre-heating. The power burner's **open flame** is located in the center of the back wall of the oven cavity. A built-in fan turns on when on the burner is in use, adding to its efficiency and consistency.

WARNING

- Use care when cooking with parchment paper, wax paper, aluminum foil or any other **FLAMMABLE OR COMBUSTIBLE MATERIALS**. Also use care when cooking with oils, fats, spirits or other **FLAMMABLE OR COMBUSTIBLE SUBSTANCES**. These materials may ignite if they come into contact with or in close proximity to the open flame. Monitor the oven at all times when using such materials.
- Do NOT allow flammable materials or substances to come in contact with the open flame of the power burner located on the back wall of the oven cavity. Such materials could ignite if they come into contact with or in close proximity to the burner flame.
- Do NOT leave oven unsupervised when drying herbs, breads, mushrooms, etc. These may pose a fire hazard.
- Do NOT allow flammable or combustible cleaning substances to come into contact with or near oven's burner. Use caution to remove such substances before turning the oven on.
- Do NOT store flammable materials on, in, or near the oven. Keep the oven area clean and free of combustible materials, gasoline and other flammable vapors and liquids, aerosol and sealed containers like baby food jars. Check before each use to make sure that no hazardous materials are in the appliance area.
- Never wear loose fitting clothing or garments with loose sleeves or string while using the oven.
- Inspect all food items before placing them in the oven for cooking. Some food items might be packaged in flammable materials. Remove packaging before use.
- Your oven is not a storage compartment. Do NOT place food, pots or pans, cooking equipment or storage containers (including paper products such as pizza boxes) in the oven when not in use. These items will ignite when the oven is turned on.
- To prevent burns from the open flame, do not insert your hand near the back of the oven.

WARNING

- Do NOT cover an entire oven rack with any material such as aluminum foil. Do NOT use any mat or oven liner on the oven floor.

These items may present a **FIRE HAZARD**. They will also block airflow through the oven and may cause carbon monoxide poisoning or trap heat, creating a FIRE HAZARD.

- Push in and turn the oven control knob counter clockwise to any temperature setting between 150° and 500°F. The blue oven indicator light will illuminate indicating the oven is on and preheating.

ATTENTION

- Although the oven is on, it may take up to one minute for the power burner to ignite. This is normal.
- The power burner cycles frequently to reach and maintain the desired cooking temperature. The power burner flame will automatically ignite and extinguish during this process.
- In about 8 minutes, the blue oven indicator light will turn off, indicating the PowR Oven™ sensor has reached the desired temperature. However, it will take up to 20 minutes for the PowR Oven™ cavity to be fully preheated at that temperature.
- The blue indicator light, located on the front control panel, will turn on every time the power burner ignites as the oven cycles to maintain the set temperature.

You may observe the following during the pre-heating process. All are normal.

ATTENTION

- Condensation on the front of the range including the oven door, oven window, control panel and side panel. It will disappear as the oven heats.
- Popping sounds as the metal in the oven expands

Convection Baking and Roasting

All Platinum™ Series PowR Oven™ are equipped with a Convection Fan. For even more efficient baking and roasting, you can use your PowR Oven™ with the Convection Fan. If you choose to use the Convection Fan, standard adjustments in temperature and time are recommended. The Convection Fan will always run at a low speed when the power burner is on. The fan will run at a high speed when the burner is not lit and if the convection switch on the front control panel is ON.



Convection Fan Switch

In general, Convection Baking and Roasting takes less time and at lower temperatures than traditional baking or roasting.

TIP

For best results when Convection Baking and Roasting

- Reduce the recommended temperature by 25°F to 50°F.
- Reduce the recommended cooking time.
- Closely monitor the first batch of each new recipe.
- Keep a record of temperature, time and weight for each recipe. Adjust accordingly for the next batch.
- Place baking dishes at the center of racks for maximum air flow, allowing at least 1" between pans.
- Select a baking dish that has no or low sides like a broiler pan so that the air can circulate freely around the food.
- Covered dishes do not benefit from Convection Baking or Roasting.

Operating the Convection Fan in the PowR Oven™

ATTENTION

Do not use the Convection Fan to broil.

- Push in and turn the oven control knob counter clockwise to any temperature setting between 150° and 500°F. The blue oven indicator light will illuminate indicating the oven is on and preheating.

ATTENTION

- Although the oven is on, it may take up to one minute for the power burner to ignite. This is normal.
- Do not use the Convection Fan during the initial preheat cycle. Wait until the blue indicator light turns off, signaling the oven has reached the desired set temperature before turning the convection fan on.
- In about 8 minutes, the blue oven indicator light will turn off, indicating the PowR Oven™ sensor has reached the desired temperature. However, it will take up to 20 minutes for the PowR Oven™ cavity to be fully preheated at that temperature.
- The blue indicator light will turn on and off as the oven cycles to maintain the set temperature.
- Turn the Convection Fan switch on the front control panel to ON after the oven has pre-heated and the blue oven indicator light has turned off. The convection fan can be turned on or off as desired from this point.

You may observe the following during the pre-heating process. All are normal.

ATTENTION

- Condensation on the front of the range including the oven door, oven window, control panel and side panel. It will disappear as the oven heats.
- Popping sounds as the metal in the oven expands

Operating the Infrared Broiler (All Models)



- **Keep the oven door closed at all times when lighting and broiling. Open only to insert or remove food.**
- **Leaving the oven door open throughout the cooking process could damage range components.**
- Do NOT put your face near the infrared broiler.
- Do NOT operate the convection fan while broiling.

- With oven door shut, push in and turn the oven thermostat control knob counter clockwise to BR (broil).
- The blue oven indicator light will illuminate.
- The broiler igniter will begin to glow and the ceramic broiler burners will light. The broiler will cycle on and off to maintain an even broiling temperature.

ATTENTION

- It takes up to 3 minutes for the burners to light.
- You may see a large flame at first. This is normal and will soon become a blanket of blue flame that will glow red.
- Note: The broiler and oven burner will not operate at the same time.

TIP

- Before turning the broiler on, determine the correct oven rack position based on the recipe, depth of the broiler pan, and food thickness and move the oven rack to the correct position.
- You can use the broiler as soon as it is lit. No need for pre-heating.

Oven Cleaning



- Do NOT clean the infrared ceramic broiler.
- Do NOT apply commercial oven cleaners to the oven door gasket. Do NOT rub or scrub the gasket since may damage the oven door seal.
- Make sure cleaning chemicals do not come in contact with any stainless steel, painted surfaces or the infrared ceramic broiler.
- Do NOT use steel wool or metal pads to clean the interior oven walls. They may damage or scratch the enamel coating.

ATTENTION

- Make sure the area is well-ventilated when using commercial oven cleaners.
- Line the floor beneath the oven door with several layers of newspaper or other protective material to catch drips and run-off.

Oven Window

- When oven is cool, and after each use, use a cloth and warm soapy water to clean the interior oven door window to remove baked-on stains. Rinse with clear water and dry thoroughly.
- For tougher stains, you can use glass cleaner. Follow cleaner manufacturer's instructions.
TIP: To prevent build-up of residue on glass, clean window after each use.

Interior Oven Walls

- The oven interior is coated with porcelain enamel and can be cleaned with commercial oven cleaners. Follow the cleaner manufacturer's instructions. Do NOT use on door gasket, igniter, or infrared ceramic broiler.
- To loosen tough baked-on stains, lay a cloth soaked in hot water on the area for several minutes Do NOT use soap and do NOT turn ON the oven.

Oven Fan Guard

- Clean the oven fan guard periodically. Keep the fan guard clear of obstructions.
- Apply commercial oven cleaner to cloth, not directly to the fan guard, to remove grease build-up and food particles. Follow manufacturer's cleaning instructions.

Oven Racks and Guides

- Remove and clean racks and guides in hot, soapy water. Rinse well and dry thoroughly.
- Racks and guides can be cleaned in the dishwasher.

CARE AND CLEANING



Make sure the cooktop surface and range are cool before cleaning.

PART/ MATERIAL	CLEANING	FREQUENCY	ATTENTION
Backguard	Clean with stainless steel cleaner. Follow cleaner manufacturer's instructions.	As needed	Do NOT use steel wool, metal pads or abrasive cleaners. Discoloration may occur with heavy use.
Burner Top Grates / Cast Iron / Burner Caps	Wash grates in hot, soapy water. Rinse well and dry thoroughly. For heavy soiling, use a commercially available oven cleaner. Follow the cleaner manufacturer's instructions.	With each use	Do not submerge in water for extended periods as this may cause rusting. Do NOT allow commercial oven cleaner to touch painted or stainless steel surfaces.
Burner Ring Grate/Cast Iron	Wash grates in hot, soapy water. Rinse well and dry thoroughly. For heavy soiling, use a commercially available oven cleaner. Follow the cleaner manufacturer's instructions.	With each use	Do not submerge in water for extended periods as this may cause rusting. Do NOT allow commercial oven cleaner to touch painted or stainless steel surfaces.
Burner Ports / Cast Iron	Use a push pin or safety pin to clear clogged burner ports.	As needed	Do not use a wooden or plastic toothpick, or any other material that can break.
Charbroiler Grates / Porcelain coated	Wash in hot soapy water using a non-metallic grill brush. Rinse well and dry thoroughly.	After every use	Clean the Charbroiler grease Drip Pan after every use.
Convection Fan Guard / Porcelain Enamel	Remove obstructions like aluminum foil or other particles. Apply commercial oven cleaner to a cloth and wipe the guard. Follow manufacturer's instructions.	Once a month; more often with frequent use.	Turn on ventilation fan and make sure room is well vented. Do NOT use steel wool, metal pads or abrasive cleaners. They may scratch and damage the coating.
Grease Pan	Remove from range. Discard grease and wash in hot soapy water. Apply stainless steel cleaner as needed with a rag, following cleaner manufacturer's instructions.	As needed depending on use.	Do NOT use abrasive sponges or steel wool.

Grease Pan Insert (open burner models only)	Remove from range. Discard grease and wash in hot soapy water. Apply stainless steel cleaner as needed with a rag, following cleaner manufacturer's instructions. Dishwasher safe.	As needed	Do NOT use abrasive sponges or steel wool. Do not clean grease pans while oven is on. Do not clean range right after use, wait until range is cool. Caution: Grease pan handles may be hot.
Exterior Body / Standard RAL Colors	Clean with hot, soapy water. Rinse well and dry thoroughly. For tough stains, apply a cloth soaked in hot water for several minutes. Scrape LIGHTLY with a nylon or rubber spatula.	As needed	Do NOT use steel wool, metal pads or abrasive cleaners. Do NOT use any metal objects to scrape the surface. Do NOT allow citrus or tomato juices to sit and dry on the surface. Citric acid will discolor stainless steel.
Exterior Body / Stainless Steel	Only moving in the direction of the grain, clean with hot, soapy water. Rinse well and dry thoroughly. For tough stains, use a commercial stainless steel cleaner and follow the cleaning manufacturer's instructions.	As needed	Do NOT use steel wool, metal pads or abrasive cleaners. Do NOT use any metal objects to scrape the surface. Do NOT allow citrus or tomato juices to sit and dry on the surface. Citric acid can discolor stainless steel.
Exterior Body / Textured Paint	Clean with hot, soapy water. Rinse well and dry thoroughly. For tough stains, apply a cloth soaked in hot water for several minutes. Scrape LIGHTLY with a nylon or rubber spatula. Be gentle when cleaning textured paint.	As needed	Do NOT use steel wool, metal pads or abrasive cleaners. Do NOT use any metal objects to scrape the surface. Do NOT allow citrus or tomato juices to sit and dry on the surface. Citric acid will discolor stainless steel.
French Top	Wipe surfaces with warm wet cloth. Dry with a cotton towel. Apply a light coat of corn oil or high smoke point oil.	As needed.	Make sure the French Top always has a light coat of oil to prevent rusting.

Griddle	<p>Clean with hot soapy water – light oil coating after cleaning.</p> <p>TIP: Pay extra attention to drip pan when using the griddle.</p>	After every use	<p>No abrasive sponges</p> <p>Clean the griddle grease Drip Pan after every use.</p>
Oven Interior / Porcelain Enamel	Use a commercial oven cleaner. Follow cleaner manufacturer’s instructions.	Once a month; more often with frequent use.	<p>Turn on ventilation fan and make sure room is well vented.</p> <p>Do NOT clean the infrared ceramic broiler. This can easily crack.</p> <p>Do NOT apply commercial oven cleaners to the oven door gasket.</p> <p>Do NOT rub or scrub the gasket. This may damage the oven door seal.</p> <p>Do NOT use steel wool, metal pads or abrasive cleaners. They may scratch and damage the coating.</p>
Oven Racks and Guides	<p>Remove and wash in hot, soapy water. Rinse well and dry thoroughly.</p> <p>Dishwasher safe.</p>	Once a month; more often with frequent use.	
Raised Griddle/Broiler	<p>Wire racks: Follow Oven Rack cleaning instructions</p> <p>Drip tray: Follow Drip Tray cleaning instructions.</p>	After every use	Do NOT put cold water on a hot griddle.

BEFORE CALLING FOR SERVICE

Check these helpful tips for any problems with your range. If you need additional help call BlueStar® Customer Service at 1-800-449-8691.

COOKTOP		
PROBLEM	POSSIBLE CAUSE	SOLUTION
Bumer will not ignite – no “clicking” sound	No electrical power to the unit. Open Bumer Models Only: Igniter not connected to lead wire. Igniter not connected to the correct lead wire Lead wire is worn or chipped. Lead wire is not connected to spark module.	Plug into a three-prong electrical outlet that is properly grounded. Check and re-set circuit breaker for the unit. Open Bumer Models Only: Connect igniter to orange lead wire. Connect igniter to the orange lead wire attached to the bumer. Check for signs of wear or chips.
Bumer will not ignite – “clicking” sound, but no spark	Gas not turned on Open Bumer Models Only: Clogged bumer ports Venturi tube not aligned with the orifice Lead wire is in the drip tray	Turn on gas supply. Open Bumer Models Only: Use a push pin to clear ports. Position venturi tube over orifice. Attach lead wire to igniter.
Bumer will not ignite – “clicking” sound with spark	Gas not turned on Bumer head OR cap not in correct location Open Bumer Models Only: Air shutter needs adjustment. Faulty igniter (dirty or cracked)	Turn on gas supply. Identify bumers and move them to the correct location. Open Bumer Models Only: See Top Bumer Low Flame Adjustment instructions.
Bumer ignites – “clicking” sound does not stop	Bumers are wet Bumer setting too low Air draft flowing over cooktop Open Bumer Models Only: Electrode wires not properly connected Electric plug not in grounded outlet.	Let bumers dry and try again. Turn off, re-ignite and change setting. Eliminate draft source. Check outlet polarity. Plug unit into a three-prong electrical outlet that is properly grounded. Open Bumer Models Only: Connect electrode wires.
Bumer doesn't fully ignite	Partial gas supply Bumer or bumer cap not properly positioned Clogged bumer ports Open Bumer Models Only: Bumer head not in correct location Low flame setting needs adjustment	Use a push pin to clear ports. Make sure gas supply is fully on. Check that bumer or cap is in the proper location. Open Bumer Models Only: See Top Bumer Air Shutter Adjustment instructions. Identify bumers and move them to the correct location.
Bumer ignition delay – “clicking” sound then ignition whoosh	Open Bumer Models Only: Air shutter needs adjustment Sealed Bumer Models Only: Knob not in the correct position	Open Bumer Models Only: Turn bumer to LOW setting to ignite. See Top Bumer Air Shutter Adjustment instructions.

		Sealed Burner Models Only: Turn burner to LOW setting to ignite.
Lazy flame – floats, larger in size than normal	Low propane supply (for LP users) Low flame setting needs adjustment	Fill the propane tank. Turn on/off valve fully to on. See Top Burner Air Shutter or Low Flame Setting instructions.
Lifting flame – well-defined with visible inner core, noisy, gap between burner and flame	Incorrect regulator setting. Low flame setting needs adjustment	Set regulator to proper setting - Liquid Propane or Natural Gas. See Top Burner Air Shutter or Low Flame Setting instructions.

OVEN		
PROBLEM	POSSIBLE CAUSE	SOLUTION
Oven will not ignite (RNB, RCS, Platinum™)	Takes up to three minutes to ignite. No electrical power to the unit. Gas not flowing to oven. Igniter does not glow red	Wait three minutes. Plug into a three-prong electrical outlet that is properly grounded. Check and re-set circuit breaker for the wall outlet used for this unit. Turn a top burner on. If top burner ignites, call for service. Make sure gas supply valve is on.
Lazy flame – floats, larger in size than normal	Low propane supply (for LP users) Needs an air shutter adjustment	Fill the propane tank. Turn on/off valve fully to on. See Oven Burner Air Shutter Adjustment instructions.
Lifting flame – well-defined with visible inner core, noisy, gap between burner and flame	Incorrect regulator setting. Air shutter adjustment	Set regulator to proper setting - Liquid Propane or Natural Gas. See Oven Burner Air Shutter Adjustment instructions.
Oven light not on	No electrical power to the unit. Oven light bulb burned out	Plug unit into a three-prong electrical outlet that is properly grounded. Check and re-set circuit breaker for the wall outlet used for the unit. Replace with 40 Watt Appliance light bulb only. See Replacing Oven Bulb instructions. Platinum only: Replace with 25 Watt.
Convection fan does not turn	No electrical power to the unit. Fan guard is obstructed or clogged.	Plug into a three-prong electrical outlet that is properly grounded. Check and re-set circuit breaker for the unit. When oven is cool, remove any obstructions like baked-on food or aluminum foil.

<p>Lazy or lifting flame on the power burner in the PowR Oven™</p>	<p>Air shutter adjustment</p>	<p>It is recommended that a certified BlueStar service provider adjust the air shutter on your PowR Oven™.</p> <p>To adjust the air shutter, make sure the range is off and cool.</p> <p>Remove screws (3-4) holding the kickplate in place.</p> <p>Locate air shutter and loosen the air shutter set screw.</p> <p>Rotate the air shutter left or right until the desired flame is achieved. Retighten the screw.</p> <p>The flame should appear blue.</p>
--	-------------------------------	---

MAINTENANCE

Oven Doors

Periodically oven door hinges may require added lubrication to work smoothly. Whether this is necessary or how frequently will depend on how and how often you use your oven. Open the door fully and apply a small amount of lubricant to the ball visible in the hinge slot on your door. We recommend a food grade light oil or grease. Cooking oil or mineral oil may be used, but should be avoided if possible. Do not use sprays like WD-40 or CRC that may get onto the oven door surface.

Air Shutters (Open Burner Models Only)

Air shutter adjustments are pre-set at the factory. However depending on a variety of factors including the type of gas supply, these adjustments may need to be fine-tuned after installation. A qualified installer should make these adjustments at the time of installation.

Any air shutter adjustments that are needed after installation are not covered by your warranty.

ATTENTION

Air Shutter Checklist

Before making any adjustments to the air shutters, verify the following:

1. Range is completely cool.
2. Gas source type (natural gas or liquid propane) matches the serial plate and is set properly. This setting is typically checked and adjusted by a service technician using a manometer.
3. Gas pressure regulator is set properly to natural gas or liquid propane.
4. Orifice is aligned and parallel with the venturi tube to the burner, the venturi is properly positioned over the orifice, and that the burner is properly seated.

TOP BURNER AIR SHUTTER ADJUSTMENT

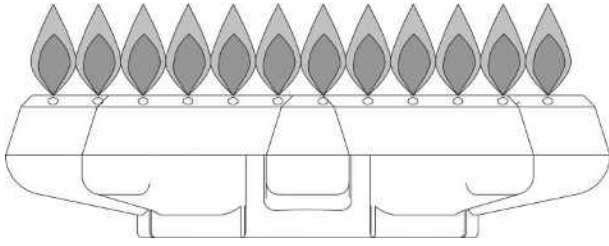

A properly adjusted burner will have sharp conical shaped blue flames. However, on some larger burners (22,000 BTU or 25,000 BTU) the cones are close together and blend into one another. The flame should be almost all blue. If your flames do not appear, follow the instructions to adjust the air shutter.

TIP Propane gas sometimes produces a yellow tipped flame. This is normal.

ATTENTION

Before you begin, follow the steps in the Air Shutter Checklist.
Make sure burner is cool.

1. Remove the ring grate, top grate, griddle or charbroiler associated with the burner(s) that need adjusting.
2. Remove the burner to expose the air shutter adjustment screw in the burner cavity.
3. Use a Phillips screwdriver to loosen the air shutter tightening screw.
4. Use your fingers to adjust the air shutter gap:
 - Widen the gap to remove yellow tips and to eliminate a lazy flame
 - Reduce the gap to remove a lifting flame.
5. Tighten the air shutter screw and replace the burner.
6. Test it to make sure the adjustments have corrected the issue.
7. If needed, turn off the burner and repeat steps 3 and 4.
8. When adjustments are complete, turn off the burner and tighten the shutter screw with the screwdriver.
9. Replace the burner and make sure the venturi is over the orifice.
10. Replace any grates and cooking sections.

TOP BURNER LOW FLAME ADJUSTMENT

At its lowest setting, a properly adjusted burner will produce a steady flame about 1/8" above the burner ports. If your flames do not appear, follow the instructions to adjust the flame height.

ATTENTION

Before you begin, follow the steps in the Air Shutter Checklist.

1. Push and turn the burner fully counter clockwise to the lowest simmer setting. Leave burner on.
2. Remove the burner knob from the valve stem by pulling the knob straight toward you. Set the knob aside.
3. Use a wrench to secure the valve stem while you make the adjustments.
4. Insert a 1/8" flat-head screwdriver blade into the "D" shaped valve stem and is inserted into the adjusting screw.
 - To lower the flame, turn the adjusting screw clockwise 1/8 of a turn at a time until the flame is at the desired height.
 - To raise the flame, turn the adjusting screw counter clockwise 1/8 of a turn at a time until the flame is at the desired height.
5. To replace the knob, align the "D" shaped cut-out on the knob with the valve stem.
6. Push the knob straight onto the valve stem and turn the knob clockwise to the off position.
7. To check new burner height: Push and turn the burner knob counter clockwise to the lowest simmer. If you hear a clicking sound but the burner does not ignite, repeat the steps to increase the flame height until the burner ignites and remains lit at the lowest simmer setting.

TIP: This adjustment will also adjust the burner's high flame setting.

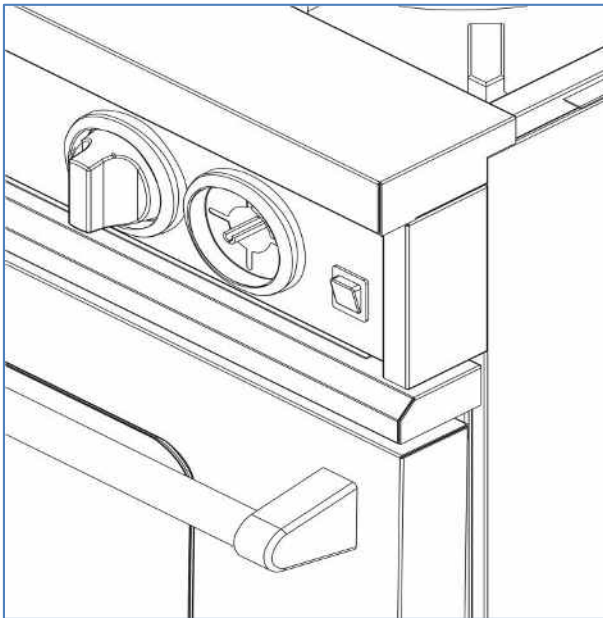

OVEN BURNER AIR SHUTTER ADJUSTMENT



WARNING

Before you begin, follow the steps in the Air Shutter Checklist.

CAUTION

Wear heavy duty gloves when removing oven door, oven floor and front panel to prevent injury from sharp edges.

ATTENTION

Oven door weighs about 25 pounds. Use extreme care when removing or replacing to prevent personal injury or property damage.

Tools needed: Phillips screwdriver, straight stubby screwdriver or a 3/16" open-end box wrench, heavy duty work gloves

Preparing the Oven for Oven Burner Air Shutter Adjustment

1. Remove oven racks from the oven and set aside.
2. Remove the oven door.
 - Open the oven door fully so it is parallel to the floor.
 - Locate the hinge clip within the hinge cavity in the oven frame.
 - Insert the tip of a flat-head screwdriver into the square opening of the hinge cavity just above the clip.
 - Use the screwdriver to rotate the clip up and out so it is facing you. Repeat for the other hinge.
 - Lift up the oven door about halfway, as if closing the door
 - Observe and remember the hinge position in the hinge receiver before you remove it. It should appear this way when replacing the door.
 - With the door halfway up, use your hands to grasp both short sides of the door near the door handle.
 - Lift the oven door straight up and out from the hinge receiver. Carefully set the door aside.
3. Remove the lower kick panel.
 - Use a Phillips head screwdriver and remove the sheet metal screws securing the kick panel. Set the screws aside.
 - Pull on the kick panel to remove it and place to the side.
4. Remove the oven floor.
 - Wearing heavy duty gloves, insert your fingers into the holes of the oven floor panel.
 - Lift panel up and out of the oven. Set aside.
5. Turn on the oven to 300°F and wait 15 minutes.

ATTENTION

Do NOT turn on the convection oven during the adjustment procedure.

6. With the oven on, locate the air shutter adjustment screw in the oven cavity. Figure xx.
7. Use a straight stubby screwdriver or a 3/16" open-end box wrench to loosen the air shutter screw.
8. Use your fingers to adjust the air shutter gap:
 - Widen the gap to remove yellow tips and to eliminate a lazy flame
 - Reduce the gap to remove a lifting flame.
9. When adjustments are complete, turn off the oven and tighten the air shutter screw with the screwdriver.

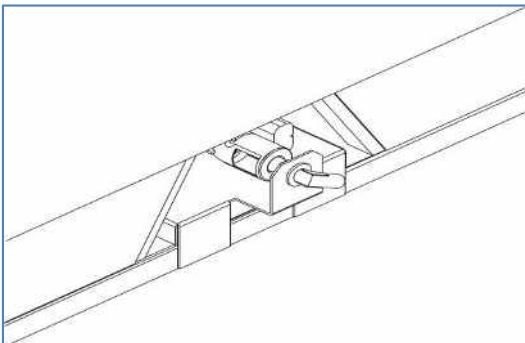

10. Wearing heavy duty gloves, replace the oven floor in the oven, making sure that the seven holes are facing you.
11. Replace the kick panel and secure with the sheet metal screws.
12. Replace the oven door
 - Grasp the door with both hands on each side of the door handle.
 - Slide the door hinges into the hinge receiver, making sure that the notch in the hinges is resting properly.
 - Rotate the hinge clip down into the hinge receiver to secure the hinge. Repeat on the other side.
13. Make sure the door lays flat and parallel to the floor when fully open.
14. Make sure the door closes smoothly and completely with no gap between the door and oven gasket.
15. If not, remove the door and repeat step 12.
16. Replace oven racks.

OVEN BULB REPLACEMENT

ATTENTION Only use a 40 Watt Appliance bulb. Regular light bulbs cannot tolerate oven temperatures.

1. Make sure oven is cool.
2. Grasp the clear globe lens with your fingers and turn counter clockwise to loosen and remove.
3. Replace the burned out bulb with a 40 Watt Appliance bulb.
4. Replace the clear globe by turning clockwise.

For Large (30") PowR Oven™ in Platinum™ Series only:

1. Pry lens from housing.
2. Lift bulb from socket.
3. Replace bulb – do not touch halogen.
4. Re-install lens making sure recess in glass is at base of bulb.

IGNITER REPLACEMENT

1. For a front burner, remove the ring grate and top grate from the burner that needs the replacement igniter. For a rear burner, remove the ring grates and top grates from both the front and rear burners.
2. Within the burner cavity, locate and disconnect the orange lead wire by pulling on the plastic connector.
3. Remove the burner assembly and attached venturi tube from the burner cavity by pulling it up and towards the back of the range until it is free.
4. Turn over the burner assembly and use a Phillips screwdriver to remove the screw that attaches the igniter to the burner head. Remove the igniter.
5. Insert the new igniter into the burner assembly, making sure it is aligned properly with the burner ports.
6. Secure the igniter to the burner assembly with the same screw.
7. Reinstall the burner assembly:
 - a. Lean over and look inside the burner cavity to see the round brass orifice which supplies the gas to the burner.
 - b. Slide the burner head assembly into the burner cavity, making sure the open end of the metal venturi tube (attached to the burner head) fits over the brass orifice.
 - c. The burner head should be level, with the two prongs on the bottom of the burner head seated through the holes on the burner support.
8. Reconnect the two orange lead wires with the plastic connector.

ATTENTION

- The wires should be located under the burner supports, and not pinched between the burner head and support.
- Make sure the wires are not resting on the drip pan.

9. Test the unit for proper operation.

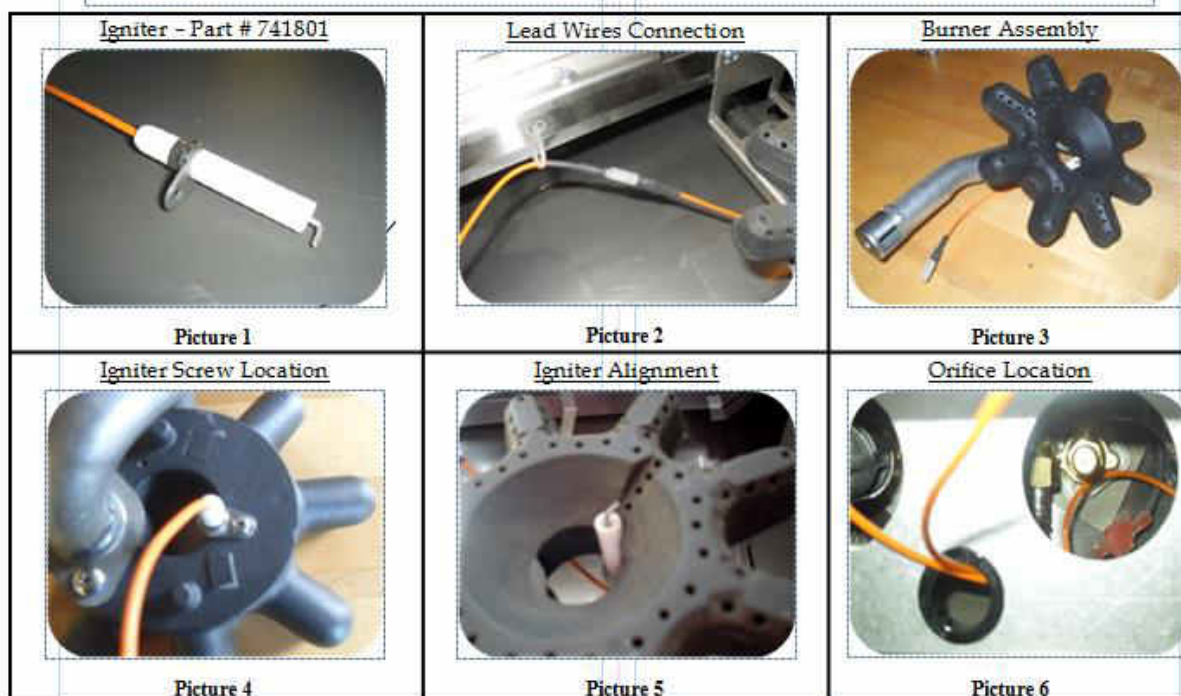

PERFORMANCE CHECKLIST

This checklist has been developed to assure proper installation of your appliance.

To validate your warranty you must mail or submit online this form within 15 days of installation and a copy of your receipt to: Warranty Department, Prizer-Painter Stove Works Inc., 328 June Avenue Blandon, PA 19510 or www.bluestarcooking.com/support/product-registration/.

Customer Information (Please Print)

Name: _____
 Address: _____
 City: _____
 State, Zip Code: _____
 E-mail: _____
 Telephone: _____
 Dealer: _____

Product Information (Please Print)

Model No: _____
 Serial No: _____
 Purchase Date: _____
 Installation Date: _____
 Installer's Name: _____
 Company: _____
 Telephone: _____

CHECK ALL THAT APPLY

Appearance and Aesthetics

- Exterior
- Top section
- Oven interior

Electrical Connection

- Correct voltage
- Grounded outlet
- Polarized outlet
- No GFCI

Installation

- Proximity to cabinets
- Level
- Backguard in place
- Ventilation system
- Read User Manual
- Review safety instructions

Gas Connection

- Verify fuel—____ Nat ____ LP
- Gas shut-off present and accessible
- Supply line properly sized
- Supply pressure checked
- Operating pressure checked
- All connections checked for leaks

Ignition

- Top Burners
- Griddle
- Char Broiler
- Oven Burner
- Infrared Broiler

Flame Adjustment

- Top Burners
- Griddle
- Char Broiler
- Oven Burner
- Infrared Broiler

Air/Gas Mixture

- Top Burners
- Griddle
- Char Broiler
- Oven Burner
- Infrared Broiler

Valve Operation

- Top Burners
- Griddle
- Char Broiler
- Oven Burner
- Infrared Broiler

Controls

- Burner knobs
- Thermostats
- Convection oven fan & switch
- Oven light switch

Oven Door

- Alignment
- Door seal
- Hinges

LIMITED WARRANTY

BlueStar® Cooking Appliances, BlueStar® Ventilation Hoods and Prizer Hoods® Ventilation Hoods

Who Is Providing The Warranty?

This Warranty is provided to you by Prizer-Painter Stove Works, Inc. ("Prizer-Painter"), which warrants the parts of your BlueStar® cooking appliance, BlueStar® ventilation hood or Prizer Hoods® ventilation hood ("Product"), as described below.

Who Does This Warranty Cover?

This Warranty covers the owner of the residence in which the Product is installed, and his or her spouse ("Owner").

To What Types Of Installations Does This Warranty Apply?

This Warranty applies to cooking appliances and ventilation hoods installed in residential properties only. The Product must be installed by a certified gas technician or licensed plumber for the warranty to apply. Self-installations or installations by a person, who is not a certified gas technician or a licensed plumber, will void this Warranty. This Warranty is also void if the original factory installed serial number is altered or removed from the Product.

What Products Does this Warranty Cover?

This Warranty applies only to BlueStar® cooking appliances, BlueStar® ventilation hoods, and Prizer Hoods® ventilation hoods purchased in the continental U.S. and Canada on or after February 22, 2002.

What Products Does this Warranty Not Cover?

This Warranty does not apply to Products installed or used in any commercial or other non-residential property such as, but not limited to, day care facilities, hotels, motels, and nursing homes. This Warranty does not cover Products installed outside the U.S. or Canada. This Warranty does not apply to gas type conversions on cooking appliances not completed by a certified gas technician, licensed plumber or certified BlueStar® servicer.

What Problems Does this Warranty Cover?

Subject to the conditions set forth below, this Warranty covers defects in materials and workmanship that appear under normal use and maintenance.

What Problems Does this Warranty Not Cover?

This Warranty does not cover, and specifically excludes:

- Damage caused by shipping.
- Damage or repairs to the porcelain igniters, calibrations and normal adjustments after installation and setup, including burner adjustments.
- Normal wear, care, and maintenance of the Product as described in the installation and operating manual, such as cleaning of parts, discoloration of the griddle, rust, gasket materials, ceramic materials, and fuses.
- Damage or repairs caused by alterations or modifications, abuse, misuse, neglect, or improper installation, instruction, handling, operation, maintenance or storage.
- Accidental or intentional damage.
- Damage or repairs caused by unauthorized service or repairs
- Damage or repairs as a result of natural disasters, fires, floods, earthquakes, winds, lightning, corrosive atmosphere, loss of electrical power to the Product for any reason, or other

conditions beyond Prizer-Painter's control.

- Damage or repairs caused by alteration for outdoor use.
- Damage or repairs caused by the use of harsh chemicals or cleaning products improperly applied.

This warranty is in lieu of all other express warranties. **ALL IMPLIED WARRANTIES, INCLUDING BUT NOT LIMITED TO WARRANTIES OF MERCHANTABILITY AND FITNESS FOR PARTICULAR PURPOSE ARE LIMITED TO THE DURATION OF THIS WARRANTY.** Some states and provinces do not allow limitations on implied warranties, so the above limitation may not apply to you.

If you are a California or Quebec resident, please refer to the section below.

THE OWNER AND PRIZER-PAINTER AGREE THAT THE REMEDIES SET OUT HEREIN ARE THE OWNER'S EXCLUSIVE REMEDIES FOR BREACH OF ALL WARRANTIES, EXPRESS OR IMPLIED.

WHETHER ANY CLAIM IS BASED ON NEGLIGENCE OR OTHER TORT, BREACH OF WARRANTY OR BREACH OF CONTRACT, OR ANY OTHER TORT THEORY, PRIZER-PAINTER SHALL IN NO EVENT BE LIABLE FOR INCIDENTAL, CONSEQUENTIAL OR SPECIAL DAMAGES, INCLUDING BUT NOT LIMITED TO EXTRA UTILITY EXPENSES, SHIPPING COSTS RELATED TO REPAIR OR REPLACEMENT OF ANY PRODUCT OR DAMAGES TO PROPERTY, RESULTING FROM BREACH OF THIS WARRANTY OR ANY IMPLIED WARRANTY. Some states and provinces do not allow the exclusion or limitation of incidental or consequential damages, so this provision may not apply to you.

When Does Warranty Coverage Begin?

Warranty coverage begins the date that the Product is originally installed. ("Installation Date").

How Long Does the Warranty Coverage Last?

Registration is not required to obtain Warranty coverage, but registration affects the length and certain other remedies available under the Warranty. If the Product is not registered, the Warranty lasts for one (1) year on all parts, including the functional component parts contained in the cast iron burner top; seven (7) days for cosmetic component defects as described below; and ninety (90) days on all floor models whether or not used for demonstration.

If the Product is properly registered with Prizer-Painter within (30) days of the installation date, the Warranty lasts for ten (10) years on cast iron burner heads and grates; one (1) year on all other functional component parts and related service; seven (7) days for cosmetic flaws as described below; and provides for extended coverage on certain floor models under the conditions described below.

• **Cosmetic Component Warranty:** This Warranty covers all cosmetic component flaws for seven (7) calendar days from the **date of delivery** of the Product to the original purchaser. Cosmetic components include top grates, ring grates, plate rail, kick panel, body sides, glass, control panel, door panel, back guards, oven seals,

light bulbs, and enameled parts. Cosmetic component flaws include visible chips, scratches, dents. All cosmetic component claims to Prizer-Painter must be made within the seven (7) day warranty period or they are void.

• **Floor Models Not Used For Demonstration:** Floor models are covered by a one (1) year limited functional parts and related services warranty, with proof of date of installation. There is no cosmetic warranty of any kind for floor models.

• **Floor Models Used For Demonstration:** Floor models used for demonstration are covered by a ninety (90) day limited parts warranty only, with proof of date of installation. There is no service or cosmetic warranty of any kind for floor models.

The replacement of a part or Product under this Warranty does not extend the Warranty period. None of these Warranty periods continues if the Product is removed from the property where it was originally installed.

How do I Register?

Registration is strongly urged. TO REGISTER, please fill out the "Performance Checklist and Warranty Form" located in the back of the Product Use and Care and Limited Warranty Manual and mail or fax (610-926-2666) the form to: Warranty Department, Prizer-Painter Stoveworks, 318 June Avenue Blandon, PA 19510-9566.

What Will Prizer-Painter Do To Correct Problems?

Prizer-Painter will furnish a replacement part, without charge, to replace any part found to be defective due to workmanship or materials under normal use and maintenance. Furnishing the replacement part is Prizer-Painter's only responsibility under this Warranty to Owners, and a no-charge replacement part is the Owner's only remedy, subject to the related conditions described below.

• **Cosmetic Components.** Prizer-Painter will provide for a factory authorized service agent, free of charge, to repair or replace any cosmetic component flaw properly reported within seven (7) calendar days from the **date of delivery** of the Product to the original purchaser.

• **Functional Components.** In addition to a replacement part, Prizer-Painter will cover reasonable labor and material costs for repair or replacement service of a functional component during the applicable Warranty period. Such repair or replacement service must be performed by a factory authorized service agent located within 100 miles roundtrip from the location of the Product. Service will be provided during normal business hours. The Owner will be responsible for any and all costs associated with additional mileage, non-standard service or overtime, and special equipment required to remove the Product so that service may be performed. The Owner is responsible for all other labor and labor related costs.

How Can An Owner Obtain Warranty Service?

All Warranty claims must be reported to Prizer-Painter Stove Works, Inc., 318 June Avenue Blandon, PA 19510-9566 prior to the expiration of the applicable Warranty Periods set forth above. If a Warranty claim is not submitted as required, such claim will be

invalid and will not be honored.

To obtain Warranty service, where applicable, the Owner must call the factory (toll free: 1-800-449-8691) to report a warranty claim, and must, at that time, provide (1) the model number of the Product, (2) the serial number of the Product, (3) proof of delivery, (4) a signed installation receipt, (5) a description of the claimed defect, and (6) proof of purchase of the Product, including the original retail receipt or invoice to establish the Warranty Period. Prizer-Painter must be given an opportunity to inspect any Product subject to a warranty claim. All warranty related service repairs must be performed by a factory authorized service agent.

This Limited Warranty gives you specific legal rights, and you may also have other rights that may vary from state to state or province to province.

California and Quebec Residents

Failure by California and Quebec residents to complete the Product registration form does not diminish their warranty rights.

Where Can Any Legal Remedies Be Pursued?

Please see the Arbitration Clause and Related Provisions, which affect your legal rights. Read this Arbitration Clause and its related provisions carefully. The Arbitration Clause is also available on Prizer-Painter's website.

ARBITRATION CLAUSE. IMPORTANT. PLEASE REVIEW THIS ARBITRATION CLAUSE. IT AFFECTS YOUR LEGAL RIGHTS.

1. Parties: This arbitration clause affects your rights against Prizer-Painter Stove Works, Inc. and any of its affiliates or employees or agents, successors, or assigns, all of whom together are referred to as “we” or “us” for ease of reference.

2. ARBITRATION REQUIREMENT: EXCEPT AS STATED BELOW, ANY DISPUTE BETWEEN YOU AND ANY OF US SHALL BE DECIDED BY NEUTRAL, BINDING ARBITRATION RATHER THAN IN COURT OR BY JURY TRIAL. “Dispute” will be given the broadest possible meaning allowable by law. It includes any dispute, claim, or controversy arising from or relating to your purchase of a Prizer-Painter Product, any warranty upon the unit, or the unit’s condition. It also includes determination of the scope or applicability of this Arbitration Clause. The arbitration requirement applies to claims in contract and tort, pursuant to statute, or otherwise.

3. CLASS-ARBITRATION WAIVER: ARBITRATION IS HANDLED ON AN INDIVIDUAL BASIS. IF A DISPUTE IS ARBITRATED, YOU AND WE EXPRESSLY WAIVE ANY RIGHT TO PARTICIPATE AS A CLASS REPRESENTATIVE OR CLASS MEMBER ON ANY CLASS CLAIM YOU MAY HAVE AGAINST US, AND US AGAINST US, OR AS A PRIVATE ATTORNEY GENERAL OR IN ANY OTHER REPRESENTATIVE CAPACITY. YOU AND WE ALSO WAIVE ANY RIGHT TO CLASS ARBITRATION OR ANY CONSOLIDATION OF INDIVIDUAL ARBITRATIONS.

4. Discovery and Other Rights: Discovery and rights to appeal in arbitration are generally more limited than in a lawsuit. This applies to both you and us. Other rights that you or we would have in court may not be available in arbitration. Please read this Arbitration Clause and consult the rules of the arbitration organizations listed below for more information.

5. SMALL CLAIMS COURT OPTION: YOU MAY CHOOSE TO LITIGATE ANY DISPUTE BETWEEN YOU AND ANY OF US IN SMALL CLAIMS COURT, RATHER THAN IN ARBITRATION, IF THE DISPUTE MEETS ALL REQUIREMENTS TO BE HEARD IN SMALL CLAIMS COURT.

6. OPTING OUT OF THIS ARBITRATION CLAUSE: YOU MAY OPT OUT OF THIS ARBITRATION CLAUSE WITHIN 60 DAYS OF WHEN WARRANTY COVERAGE BEGINS, IF YOU INFORM PRIZER-PAINTER IN WRITING, VIA REGISTERED MAIL (SENT TO PRIZER-PAINTER CONSUMER AFFAIRS , Prizer-Painter Stoveworks, 318 June Avenue Blandon, PA 19510-9566. THAT YOU ARE OPTING OUT. There is no other procedure to opt out. Opting out of this Arbitration Clause will not affect your other rights under this warranty.

7. Governing Law: The procedures and effect of the arbitration clause will be governed by the Federal Arbitration Act (9 U.S.C. § 1 *et seq.*) rather than by state law concerning arbitration. The law governing your substantive warranty rights and other claims will be the law of the state in which you purchased your Prizer-Painter Product. Any court having jurisdiction may enter judgment on the arbitration award.

8. Rules of the Arbitration: If the amount in controversy is less than \$50,000, the arbitration will be decided by a single arbitrator. If the amount in controversy is greater than or equal to \$50,000, the arbitration will be decided by a panel of three arbitrators. The arbitrator(s) will be chosen pursuant to the rules of the administering arbitration organization. You may choose either of the following arbitration organizations, and its applicable rules: the American Arbitration Association, 1633 Broadway, 10th Floor, New York, NY 10019 (www.adr.org), JAMS, 1920 Main Street, Ste. 300, Irvine, CA 92614 (www.jamsadr.com), or any other organization that you may choose subject to our approval. These organizations’ rules can be obtained by contacting the organization or visiting its website. If the chosen arbitration organization’s rules conflict with this Arbitration Clause, the provisions of this Arbitration Clause control. The award of the arbitrator(s) shall be final and binding on all parties.

9. Location of the Arbitration Hearing: Unless applicable law provides otherwise, the arbitration hearing will be conducted in the federal district in which you reside.

10. Costs of the Arbitration: Each party is responsible for its own attorney, expert and other fees, unless awarded by the arbitrator(s) under applicable law. Prizer-Painter will pay your share of the fees charged by the arbitration organization and arbitrator(s) beyond the first \$200. Where permissible by law, you may be required to reimburse Prizer-Painter for the fees of the arbitration organization and arbitrator(s) in whole or in part by decision of the arbitrator(s) at the discretion of the arbitrator(s).

11. Survival and Enforceability of this Arbitration Clause: This Arbitration Clause shall survive the expiration or termination, or any transfer, of the warranty on your unit. If any part of this Arbitration Clause, except waivers of class-action rights, is found to be unenforceable for any reason, the remainder shall remain enforceable. If, in a case in which class-action allegations have been, a waiver of class-action rights is found to be unenforceable with respect to all or some parts of a dispute, the remainder of this Arbitration Clause shall be unenforceable as those parts. Instead, those parts will be severed and proceed in court, with the remaining parts proceeding in arbitration.

Owner Name: _____

Address of Installation: _____

City/State-Province/Zip-Postal Code: _____

Phone #: _____

Model #: _____ Serial #: _____

Installation Date: _____