

# **Blomberg®**

seit 1883

## **Front-Loading Dryer**

Owner's Guide:

Installation and Operation Instructions

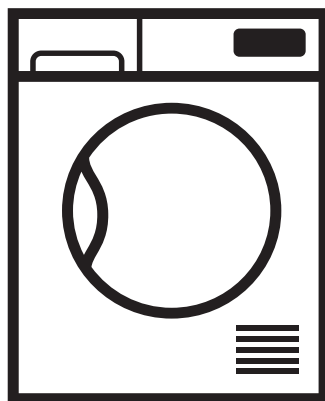

**DV 17600 W**



## Please read this user manual first!

Dear Customer,

Thank you for preferring a Blomberg product. We hope that your product which has been manufactured with high quality and technology will give you the best results. We advise you to read through this manual and the other accompanying documentation carefully before using your product and keep it for future reference. If you transfer the product to someone else, give its manual as well. Pay attention to all details and warnings specified in the user manual and follow the instructions given therein.



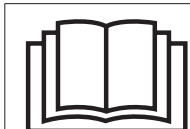



Use this user manual for the model indicated on the cover page.



Read the instructions.

## Explanation of symbols

Throughout this user manual the following symbols are used:

|  |  |
|--|--|
|    | Important information or useful hints about usage.   |
|    | Warning for hazardous situations with regard to life and property.   |
|    | Warning against electric shock.  |
|    | Warning against hot surfaces.  |
|   | Warning against fire hazard.   |
|  | Packaging materials of the product are manufactured from recyclable materials in accordance with our National Environment Regulations. |

Do not dispose of the packaging wastes with the domestic waste or other wastes, discard them to the dedicated collection points designated by the local authorities.

# TABLE OF CONTENTS

|   |           |   |           |
|---|-----------|---|-----------|
| <b>1 Your Dryer</b>                               | <b>4</b>  | <b>6 Technical Specifications</b>                   | <b>21</b> |
| <b>2 Important Safety Instructions</b>            | <b>5</b>  | <b>7 User maintenance and cleaning instructions</b> | <b>22</b> |
| <b>3 Installation Instructions</b>                | <b>9</b>  | 7.1 Lint filter .....                               | 22        |
| 3.1 Electrical connection.....                    | 8         | 7.2 Sensor .....                                    | 22        |
| 3.2 Grounding Instructions .....                  | 10        | <b>8 Troubleshooting</b>                            | <b>23</b> |
| 3.3 Appropriate installation location.....        | 11        | <b>9 Warranty Statement</b>                         | <b>24</b> |
| 3.4 Minimum Installation Clearances.....          | 12        |   |           |
| 3.5 Use on top of a washer.....                   | 12        |   |           |
| 3.6 Adjusting the feet.....                       | 13        |   |           |
| 3.7 Ventilation duct and connection .....         | 13        |   |           |
| 3.8 Destroying packaging material .....           | 14        |   |           |
| <b>4 Operating Instructions</b>                   | <b>15</b> |   |           |
| 4.1 First Use .....                               | 15        |   |           |
| 4.2 Garments suitable for drying .....            | 15        |   |           |
| 4.3 Garments unsuitable for drying .....          | 15        |   |           |
| 4.4 Preparing clothes to be dried.....            | 16        |   |           |
| 4.5 Correct load capacity.....                    | 16        |   |           |
| <b>5 Operating the product</b>                    | <b>17</b> |   |           |
| 5.1 Control Panel.....                            | 17        |   |           |
| 5.2 Symbols.....                                  | 17        |   |           |
| 5.3. Preparation of drying machine.....           | 17        |   |           |
| 5.4 Program selection and consumption chart.....  | 18        |   |           |
| 5.5 Auxiliary functions.....                      | 19        |   |           |
| 5.6 Warning indicators.....                       | 19        |   |           |
| 5.7 Starting the program.....                     | 19        |   |           |
| 5.8 Child Lock.....                               | 19        |   |           |
| 5.9 Changing the program after it is started..... | 20        |   |           |
| 5.10 Cancelling the program .....                 | 20        |   |           |
| 5.11 End of program .....                         | 20        |   |           |

# 1 Your Dryer

## Overview

Figure 1

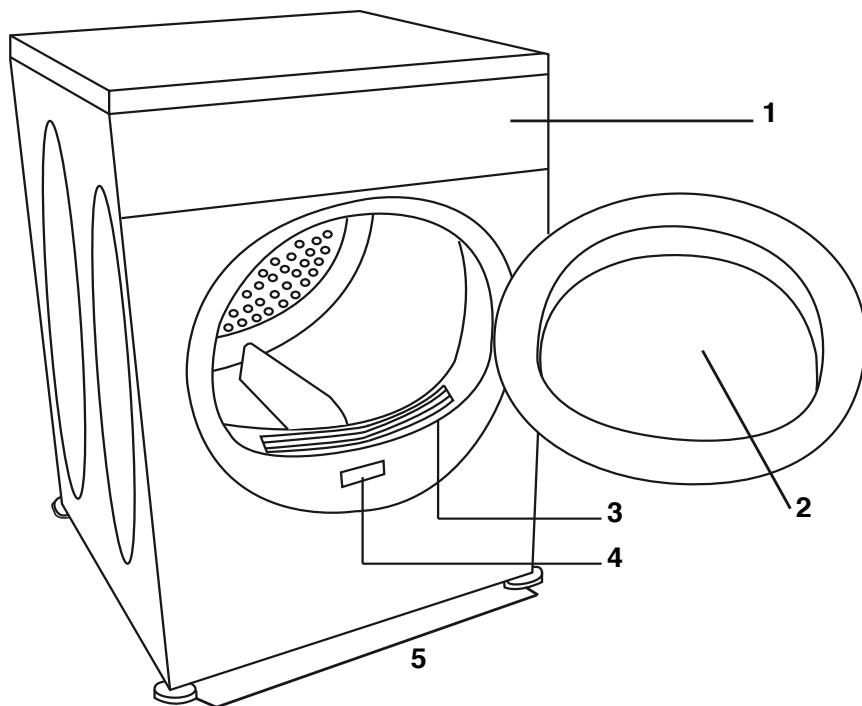

**1** Control Panel

**2** Loading Door

**3** Lint Filter

**4** Type label

**5** Adjustable Feet

**NOTE:** Specifications of this appliance may change without notice to improve the quality of the product. Drawings in this manual are schematic and may not match your product exactly. Values stated on the dryer labels or in the documentation accompanying it are obtained in the laboratory in accordance with relevant standards. Depending on operational and environmental conditions of the appliance, values may vary.

## 2 Important Safety Instructions



**WARNING:** To reduce the risk of fire or electric shock resulting in serious injury or death when using this appliance, follow the basic precautions including the following:

- Read all instructions before using the appliance. Failure to follow these instructions will increase the risk of fire or electric shock and will void the warranty.



This product has been designed for home use only.

- The appliance must be operated at temperatures between +5°C and +35°C. (41°F and +95°F)
- The appliance must not be installed behind a lockable door, a sliding door or a door with the hinges on the opposite side to that of the tumble dryer.
- Do not install or store this appliance where it will be exposed to weather.
- Do not tamper with the controls.
- Do not repair or replace any part of the appliance or attempt any servicing unless specifically recommended in the user-maintenance instructions or in published user-repair instructions that you understand and have the skills to carry out.
- Never wash the appliance with water.
- Never touch the plug with wet hands.
- Never pull from the cable to unplug the dryer.
- Do not operate the appliance if the power cord or plug is damaged.
- For malfunctions that cannot be solved by information in the operating manual: Turn off and unplug the appliance and call an authorized service provider.

- This appliance must be grounded. In the event of malfunction or breakdown, grounding will reduce the risk of electric shock by providing a path of least resistance for electric current. This appliance is equipped with a cord having an equipment-grounding conductor and a grounded plug. The plug must be plugged into an appropriate outlet that is properly installed and grounded in accordance with all local codes and ordinances.



**WARNING:** Improper connection of the equipment-grounding conductor can result in a risk of electric shock. Check with a qualified electrician or service representative or personnel if you are in doubt as to whether the appliance is properly grounded.

- Power cord plug must be within easy reach after installation.
- To reduce the risk of fire or electric shock, do not use extension cords, multi-plugs or an adapter to connect the dryer to electrical mains.
- Do not modify the plug provided with the appliance: if it will not fit the outlet, have a proper outlet installed by a qualified electrician.
- If the power supply cord is damaged, it must be replaced by the manufacturer, its service agent or similarly qualified persons in order to avoid an electrical hazard.
- The appliance must not be operated unless it is repaired!
- Ventilation openings in the base must not be obstructed by carpets, etc.
- Exhaust air must not be discharged into a flue used for exhausting fumes from appliances burning gas or other fuels.
- Adequate ventilation must be provided to avoid the back flow of gases into the room from appliances burning other fuels, including open fires.
- Do not dry articles that have been previously cleaned in, washed in, soaked in or spotted with gasoline, dry-cleaning solvents or other flammable or explosive substances as they

give off vapors that could ignite or explode.

- Do not use the tumble dryer if industrial chemicals have been used for cleaning what you want to dry.
- Do not dry unwashed items in the tumble dryer.
- Do not place items exposed to cooking oils in your dryer. Items contaminated with cooking oils may contribute to a chemical reaction that could cause a load to catch fire.
- Items such as foam rubber (latex foam), shower caps, waterproof textiles, rubber-backed articles and clothes or pillows fitted with foam rubber pads should not be dried in the tumble dryer.
- Do not use fabric softeners or products to eliminate static unless recommended by the manufacturer of the fabric softener or product.
- The appliance may only be used for the drying of textiles that are marked accordingly.
- Undergarments that contain metal reinforcements should not be placed in a tumble dryer. Damage to the tumble dryer can result if any of the metal reinforcement come loose during drying.
- Before loading check all garments for lighters, coins, metal pieces, needles, etc.
- The use of fabric softener sheets is not recommended.
- The final part of a tumble dryer cycle occurs without heat (the cool-down cycle) to ensure that the items are left at a temperature that ensures the items are not damaged by getting too hot.



**WARNING:** Never stop the tumble dryer before the end of the drying cycle unless all items are quickly removed and spread out to dissipate heat.

- Do not reach into the appliance if the drum is moving.
- Do not allow children to play on or in the appliance. Close supervision of children is necessary when the appliance is used near children.

- Keep pets away from the appliance during the drying cycle.
- Before the appliance is removed from service or discarded, remove the door to the drying compartment.
- Close the loading door when you leave the area where the dryer is located.
- This appliance is not intended for use by persons (including children) with reduced physical, sensory or mental capabilities, or lack of experience and knowledge, unless they are supervised or have been given instructions concerning the use of the appliance by a person responsible for their safety.
- Clean lint filter before or after each load.
- Keep area around the exhaust vent and adjacent surrounding areas free from the accumulation of lint, dust, and dirt.
- The interior of the appliance and exhaust ductwork should be cleaned periodically by qualified service personnel.
- Never use the dryer without the lint filter.
- When your dryer is not in use or after the laundry is taken out following the completion of drying process, turn off by using the On/Off button. In cases when the On/Off button is in the On position while the dryer is plugged in, keep the door of the dryer closed.
- For power saving in models with lamps, when your dryer is not in use, keep the door closed if the On/Off button is in the On position and the dryer is energized.



**WARNING:** This product can expose you to chemicals including Nickel (Metallic) which is known to the State of California to cause cancer.  
 For more information go to [www.P65Warnings.ca.gov](http://www.P65Warnings.ca.gov)  
 Note : Nickel is a component in all stainless steel and some other metal components.

## SAVE THESE INSTRUCTIONS



# 3 Installation Instructions



**WARNING: Failure to follow these instructions could result in a risk of fire**



Neutral connection is not used in this product

- The clothes dryer (“appliance”) installation must be performed by a qualified installer.
- Install the appliance according to the manufacturer’s instructions and local codes.
- Do not install a clothes dryer with flexible plastic venting materials. If flexible metal (foil type) duct is installed, it must be of a specific type identified by the appliance manufacturer as suitable for use with clothes dryers. Flexible venting materials are known to collapse, be easily crushed, and trap lint. These conditions will obstruct the clothes dryer’s airflow and increase the risk of fire.

## SAVE THESE INSTRUCTIONS

### 3.1 Electrical connection

Connect the appliance to a grounded outlet protected by a fuse or circuit breaker of suitable capacity.

|                                   |   |
|-----------------------------------|---|
| <p>4-wire receptacle (14-30R)</p> | <p>Dryer shipped with cord to fit this type 4 -wire receptacle</p>                              |
| <p>3-wire receptacle (10-30R)</p> | <p>If you have 3-wire receptacle, like this, a 3-wire dryer cord must be purchased locally.</p> |

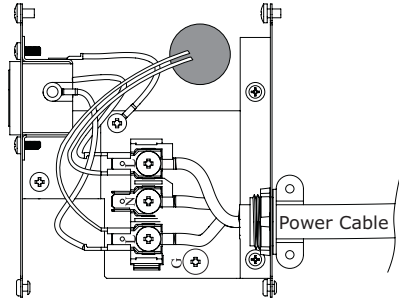

### 3-Wire Electrical Connection

If your receptacle is a 3-wire receptacle as shown below, you must obtain a 3-wire dryer cord. A dryer cord can usually be found at your local hardware supply, electrical supply or home center. Cord should have closed loop or upturned end wire terminating connectors. The cord kit must be marked “For Use with Clothes Dryers”.

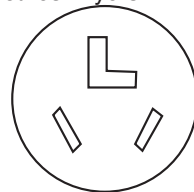

3- wire receptacle ( 10-30R)

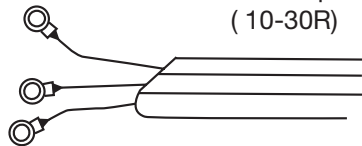

Typical 3- Wire Dryer Cord 240V/30 amp NEMA 10-30 Type SRDT



If the dryer is installed in a mobile home, recreational vehicles, new branch-circuit installations or in areas where local codes do not permit grounding through the neutral conductor, only a 4-wire power supply cord shall be used.

## To change the cord:

1. Make sure that the dryer is not plugged into any power outlet.



DO NOT plug end of dryer power cord into a live receptacle before connecting dryer power cord to dryer terminals and closing junction/splitter box as described below.



DO NOT repair old power supply cords. Power cord must be changed only by a qualified person. There is a risk of electric shock!

2. Remove the screw from the cover of the junction box located at the top rear of the dryer.
3. Remove the red, white and black wire from the terminal block.
4. Remove the green ground wire from the ground terminal.
5. Loosen the strain relief clamp holding the 4-wire cable.
6. Thread the 4-wire cable out through the strain relief clamp.
7. Thread the new 3-wire dryer cord through the strain relief clamp.
8. Attach the power cord Ground conductor (the center wire) to the terminal labeled N. Connect the terminal labeled N and the Ground terminal labeled G with the supplied short cable. Tighten the terminals so that they securely hold the conductors.
9. Attach the two remaining power cord outer conductors to the 2 terminals labeled L. Tighten both screws so that the power conductors are securely held in place.
10. Tighten the strain relief so that the power cord cannot be moved.
11. Replace the cover on the junction box and fasten in place.

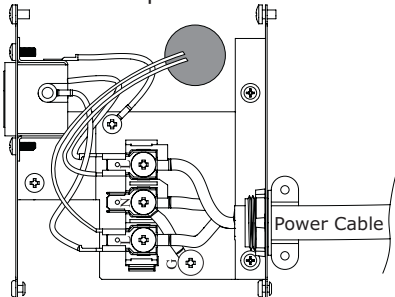

The dryer is now ready to be plugged into the 3-wire receptacle of the proper rating.

The receptacle should be located so that the plug and receptacle will be accessible with the dryer in its installed position.

## 3.2 Grounding Instructions

This appliance must be grounded. In the event of malfunction or breakdown, grounding will reduce the risk of electric shock by providing a path of least resistance for electric current. This appliance is equipped with a cord having an equipment-grounding conductor and a grounding plug. The plug must be plugged into an appropriate outlet that is properly installed and grounded in accordance with all local codes and ordinances.

- Power cord plug must be within easy reach after installation.
- The voltage and the allowed fuse/breaker protection are specified in the section "Technical Specifications".
- The stated voltage must match your mains voltage.
- Connection via extension cords or multi-plugs should not be made.
- The main fuse/breaker and switches must have a contact distance of minimum 3 mm.



A damaged power cable must be replaced by a qualified electrician.



**WARNING – Improper connection of the equipment-grounding conductor can result in a risk of electric shock. Check with a qualified electrician or service representative or personnel if you are in doubt as to whether the appliance is properly grounded. Do not modify the plug provided with the appliance: if it will not fit the outlet, have a proper outlet installed by a qualified electrician.**



The appliance must not be operated unless it is repaired!  
There is the risk of electric shock!

### 3.3 Appropriate installation location

- Install your appliance in environments that have no risk of freezing and are in a stable and level position.
- Do not place your appliance on a high pile rug or on similar surfaces.
- Operate your appliance in a well-ventilated, dust-free environment.
- Do not block the air ducts in front of and under the dryer.



Make sure that your appliance is not placed on the power cable.



Keep appliance at least 0.6" (1.5 cm) from the edges of other furniture.

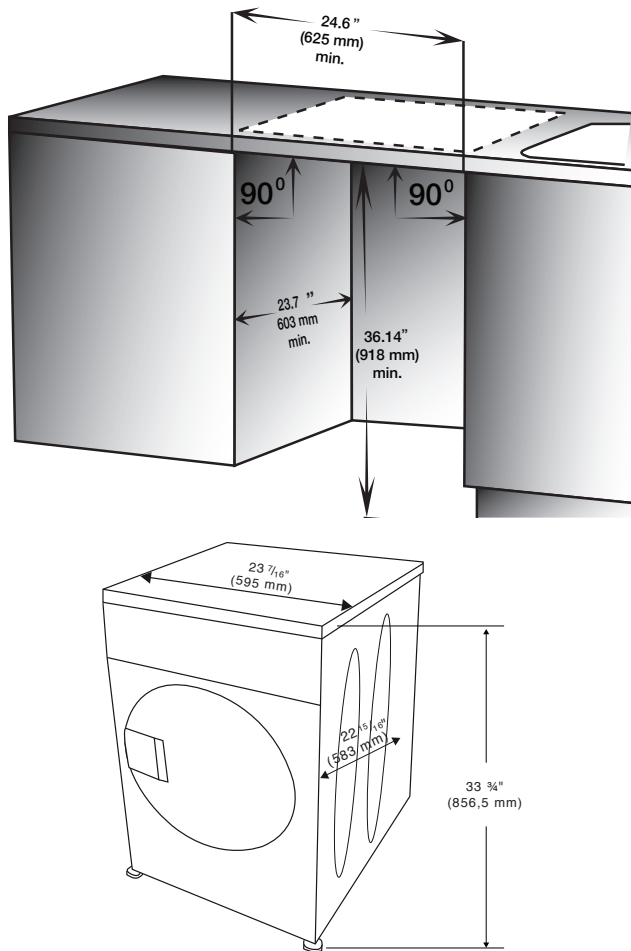

### 3.4 Minimum Installation Clearances

|       | Alcove or Built-under | Closet             |
|-------|-----------------------|--------------------|
| Sides | 0.59 in. (15 mm)      | 0.59 in. (15 mm)   |
| Top   | 2.42 in. (61.5 mm)    | 2.42 in. (61.5 mm) |
| Rear  | 0.59 in. (15 mm)      | 0.59 in. (15 mm)   |
| Front | 0.2 in. (5 mm)        | 0.2 in. (5 mm)     |

### Ventilation Requirements

Closet door must have 2 openings, one located 3.2 inches (8 cm) from bottom of door having a minimum area of 16 sq. inches (103 cm<sup>2</sup>) and the other one located 3 inches (7.5 cm) from top of door having a minimum area of 46 sq. inches (294 cm<sup>2</sup>).

### 3.5 Use on top of a washer

•A stacking-kit (Part no: 297 956 0100) should be used between the washer and dryer for use on top of a washer. The stacking-kit should be installed by the Authorized Service provider.

•Place the appliance on a solid floor. If it is to be placed on top of a washer, the approximate weight together may reach 397 lbs (180 kg) when they are full. Therefore, the floor must be capable of carrying the load placed on it!

### 3.6 Adjusting the feet

In order to ensure that your appliance operates almost silently and vibration-free, it must stand level and balanced on its feet. The all feet of the appliance can be adjusted. Balance the appliance by adjusting the feet.



Do not use any tools to loosen the adjustable feet. Otherwise, they may be damaged.



Never unscrew the adjustable feet from their housings.

### 3.7 Ventilation duct and connection

Ventilation duct ensures exhaust of air from inside the appliance.

The vented dryer has 1 air outlet.



Only rigid or flexible metal duct should be used for exhausting.





• In Canada, the diameter of the duct to be used should be 4" (102 mm). In United States, the regulation for the required exhaust duct diameter must be followed. Maximum duct length is given in the table below:



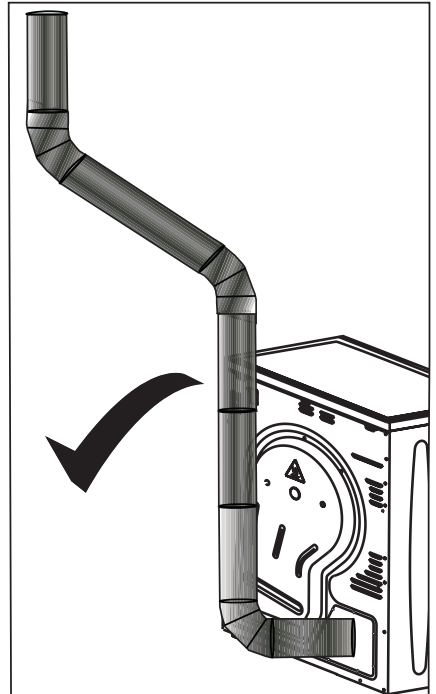
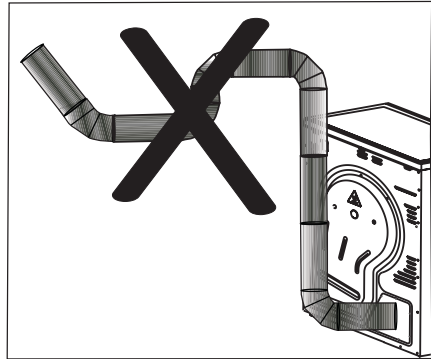

| Metal rigid duct |                           |
|------------------|---------------------------|
| Maximum length   | 72 ft (21.9 m) + 2 elbows |

To connect a ventilation duct:

1. Connect the air outlet metal duct to the spacer by turning it counter-clockwise.
2. Make the duct passages as shown in the illustration below.



|  |  |
|--|--|
|   | Exhaust of humid air from the dryer into the room is to be avoided. It may damage the walls and furniture in the room.   |
|  | The ventilation duct can be routed outdoors via a window or it can be connected to the air outlet in a bathroom.   |
|  | Air outlet duct must be extended directly outdoors. There must be a limited number of elbows to not hinder air flow.   |
|  | To prevent water accumulation in the duct, make sure it is not folded on the floor.  |
|  | In Canada only those foil-type flexible ducts, if any, specifically identified for use with the appliance by the manufacturer shall be used. In the United States, only those foil-type flexible ducts, if any, specifically identified for use with the appliance by the manufacturer and that comply with the Outline for Clothes Dryer Transition Duct, Subject 2158A, shall be used. |



|   |  |
|---|--|
|   | Care must be taken not to pinch or bend the ducts.   |
|  | The end of the hose should not be bent, it should not be stepped on and it must not be folded between the drain and the dryer. |
|  | The total length of flexible metal duct shall not exceed 7.8 foot (2.4 m).   |
|  | The duct shall not be assembled with screws or other fastening means that extend inside the duct to catch lint.                |

|   |   |
|---|---|
|  | The appliance should not be vented into a chimney, a wall, a ceiling, an attic, a crawl space or a concealed space of a building. |
|---|---|

### 3.8 Destroying packaging material

|   |  |
|---|--|
|  | Packaging material can be dangerous to children. Keep the packaging materials out of the reach of children or dispose of them accordingly. |
|---|--|

Do not dispose of them together with normal domestic waste.  
Packaging materials of your appliance are manufactured from recyclable materials.

|   |  |
|---|--|
|   | The appliance should not be vented into a chimney, a wall, a ceiling, an attic, a crawl space or a concealed space of a building.  |
|  | Do not operate the appliance at the same time with heaters such as a coal or gas stove. Airflow may cause the chimney to flare up. |

## 4 Operating Instructions



**WARNING:** To reduce the risk of fire, electric shock, or personal injury, read the **2. IMPORTANT SAFETY INSTRUCTIONS** before operating this appliance.

### LAUNDRY DRYING SYMBOLS

|  |                |  |                    |  |         |  |                          |  |                       |  |            |  |                  |
|--|----------------|--|--------------------|--|---------|--|--------------------------|--|-----------------------|--|------------|--|------------------|
|  | Drying Symbols |  | Suitable for dryer |  | No Iron |  | Sensitive / Delicate dry |  | Do not dry with dryer |  | Do not dry |  | Do not dry-clean |
|--|----------------|--|--------------------|--|---------|--|--------------------------|--|-----------------------|--|------------|--|------------------|

|  |  |                 |  |                    |  |                     |  |                       |  |                    |  |                 |  |             |  |            |  |                 |  |                      |  |               |
|--|--|-----------------|--|--------------------|--|---------------------|--|-----------------------|--|--------------------|--|-----------------|--|-------------|--|------------|--|-----------------|--|----------------------|--|---------------|
|  |  | Drying Settings |  | At any temperature |  | At high temperature |  | At medium temperature |  | At low temperature |  | Without heating |  | Hang to dry |  | Lay to dry |  | Hang wet to dry |  | Lay in shadow to dry |  | Dry-cleanable |
|--|--|-----------------|--|--------------------|--|---------------------|--|-----------------------|--|--------------------|--|-----------------|--|-------------|--|------------|--|-----------------|--|----------------------|--|---------------|

|      |                     |                  |                          |                  |                            |  |                         |  |             |  |                    |
|------|---------------------|------------------|--------------------------|------------------|----------------------------|--|-------------------------|--|-------------|--|--------------------|
|      | Iron -              |                  | Iron at high temperature |                  | Iron at medium temperature |  | Iron at low temperature |  | Do not iron |  | Iron without steam |
| IRON | Dry or Steam        |                  |                          |                  |                            |  |                         |  |             |  |                    |
|      | Maximum temperature | 200 °C<br>392 °F | 150 °C<br>302 °F         | 110 °C<br>230 °F |                            |  |                         |  |             |  |                    |

### 4.1 First Use

- When operating your dryer for the first time check inside the drum for any foreign objects.
- Partly load the drum with wet clothes and let the dryer run for approximately 15 minutes. This operation will clean the drum before loading garments.
- You may smell an unpleasant odor and excessive fiber/lint may accumulate during the first drying cycle.

### 4.2 Garments suitable for drying

Always follow the advice on garment labels. Dry only laundry having a label stating that they are suitable for tumble-drying.

### 4.3 Garments unsuitable for drying

- Items with metal attachments like, belt buckles and metal buttons can damage your dryer.
- Do not dry items like woolens, silk garments and nylon stockings, delicate embroidered fabrics, garments with metal accessories and items like sleeping bags in the dryer.
- Garments made of delicate and valuable fabrics as well as lace curtains can be permanently wrinkled. Do not dry these in your dryer!
- Do not dry items made of hermetic fibers such as pillows and quilts in the dryer.
- Garments made of foam or rubber may deform.
- Do not dry clothes containing rubber in the dryer.
- Do not dry clothes exposed to petroleum, oil, combustible or explosive agents in the dryer even if they are washed beforehand.

•Overly wet laundry or laundry with dripping water must not be put into the dryer.

## 4.4 Preparing clothes to be dried

•All laundry must be spun at the highest possible spin speed the washer allows for the textile type.

•Laundry may be tangled after washing. Separate laundry before placing them into your dryer.

•Sort laundry according to their types and thicknesses. Dry similar types of laundry together.

## 4.5 Correct load capacity

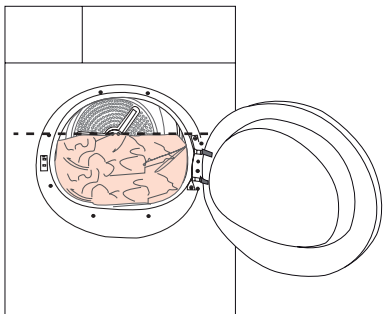

Please consult the information in the “Program Selection” section.



Adding laundry to the dryer over the level shown in the figure is not recommended. Drying performance will be reduced when the dryer is overloaded. Doing so may damage your dryer and your clothes.



Place garments into the drum loosely so they won't get tangled.



Large items (e.g. bed sheets, quilt covers, large tablecloths) may bunch-up. Stop the dryer 1 or 2 times during drying process to separate any bunched-up laundry.

The following weights are given as examples.

| Home articles               | Weight (g)* | Weight (lb)* |
|-----------------------------|-------------|--------------|
| Cotton quit covers (double) | 1500        | 3 ¼          |
| Cotton quit covers (single) | 1000        | 2 ¼          |
| Bed sheets (double)         | 500         | 1 1/8        |
| Bed sheets (single)         | 350         | ¾            |
| Large tablecloths           | 700         | 1 ½          |
| Small tablecloths           | 250         | ½            |
| Tea napkins                 | 100         | ¼            |
| Bath towels                 | 700         | 1 ½          |
| Hand towels                 | 350         | ¾            |
| Garments                    | Weight (g)* | Weight (lb)* |
| Blouses                     | 150         | 3/8          |
| Cotton shirts               | 300         | 5/8          |
| Shirts                      | 200         | ½            |
| Cotton dresses              | 500         | 1 1/8        |
| Dresses                     | 350         | ¾            |
| Jeans                       | 700         | 1 ½          |
| Handkerchiefs (10 pieces)   | 100         | ¼            |
| T-Shirts                    | 125         | ¼            |

\*Dry laundry weight before washing. Approximate weights of average home laundry type.



## 5 Operating the product

### 5.1 Control Panel

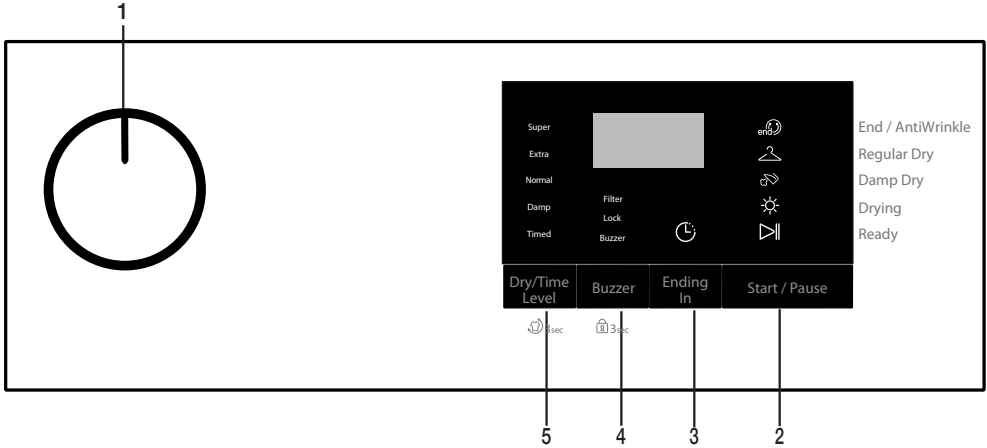

1. On/Off/Program selection button
2. Start/Pause button
3. End Time button
4. Buzzer volume button
5. Drying level/Time programs selection button

### 5.2 Symbols



### 5.3. Preparation of drying machine

- Plug the drying machine.
- Open the loading door.
- Place the laundry to the drying machine without jamming them.
- Push and close the loading door.

 Ensure that no laundry is jammed to the loading door.



Select the desired program using the On/ Off/Program selection knob, the machine will turn on.



Selecting a program using the On/Off/Program selection button does not mean that the program started. Press the Start / Stand-by button to start the program.

## 5.4 Program selection and consumption chart

| EN                             |            |                                     |                       |  |
|--------------------------------|------------|-------------------------------------|-----------------------|--|
| Programs                       | Wight (lb) | Spin speed in washing machine (rpm) | Drying time (minutes) | Explanation  |
| Cottons/Normal                 | 15         | Medium                              | 121                   | Durable clothing can be dried with this program at a normal temperature.   |
| Perm Press                     | 7          | Low                                 | 55                    | Less durable clothing can be dried with this program at a lower temperature compared to the cottons program. It is recommended for synthetic clothing (e.g.)   |
| Heavy Duty                     | 8          | Medium                              | 131                   | Use for heavy -duty clothes such as jeans or garmets should be extra dry.  |
| Mixed fabric                   | 8          | Medium                              | 85                    | Mix program (Regular Dry) is for mixed loads with different types of fabrics. Mixed laundry can be dried at a lower temperature.   |
| Sanitize                       | 11         | Medium                              | 125                   | It is a long-term program that you can use for the clothes (baby clothes, towels, underwear, etc. cotton) you require hygiene. Hygiene is provided with high temperature. It is especially suitable for durable fabrics. Do not dry use this program for delicate fabrics. Super drying level is recommended to kill high incidence of bacteria. |
| Timed Dryer (High temperature) | -          | Medium                              | 10                    | Timed programs can be selected to reach the desired final drying level at high temperatures.   |
| Timed Dryer (low temperature)  | -          | Medium                              | 10                    | Timed programs can be selected to reach the desired final drying level at low temperatures.  |
| Air fluff                      | -          | -                                   | 10                    | Only cool air circulation is performed for 10 minutes without providing hot air.   |
| Wool                           | 4          | Low                                 | 20                    | Use for shofting is wool items and garments made of wool blend such as sweaters, scarves,head scarves. It prepares wool garmets for drying with low air tempeature.  |
| Towel                          | 11         | Medium                              | 95                    | Drying towels such as kitchen towel, bath towel and hand towel.  |
| Wrinkle Free                   | 2          | Medium                              | 40                    | Dries the shirts in a more sensitive way so that they are less wrinkled and ironed easily.   |
| Delicates                      | 3          | Low                                 | 40                    | Very delicate laundry (silk blouses, fine underwear, etc.) can be dried at a lower temperature that are suitable for drying or for laundry that is advised to be handwashed.   |
| Sports wear                    | 8          | Medium                              | 85                    | Use for drying sport, fitness, and casual polyester blended garments.  |
| Bedding                        | 5          | High                                | 40                    | Drying cotton beddings such as bedlinen, sheets, bed cover, pillow case  |
| Quick Dry                      | 2          | High                                | 45                    | For the small loads of qualified fabrics with short drying times such as synthetic clothing  |

## Drying level

|        |  |
|--------|--|
| Super  | Use for heavy-duty fabrics in to be very dry                             |
| Extra  | Use for extra drying   |
| Normal | Use for normal dryness level. It is recommended level for energy saving. |
| Damp   | Items can be partially damp  |

## 5.5 Auxiliary functions

### Buzzer / time

Drying machine makes an audible warning when the program is completed. If you don't want the machine to make an audible warning, press the "Buzzer / Time" button. When you press the Buzzer/Time button, a light will illuminate and no audible warning will be made when the program ends.



You can select this function before or after the program starts.

Dry/Time level button is used to adjust program duration while the timed programs are selected.

### Drying Level

Dry/Time Level button is used for adjusting to desired dryness level. Program duration may change depending on the selection.



You can activate this function only prior to start of program.

### End time

You can delay the end time of the program up to 24 hours with End time function.

1. Open the loading door and place the laundry.
2. Select the drying program.
3. Press the End Time selection button and set the delay time you wish. End Time LED will illuminate. (When pressed and hold the button, End Time proceeds non-stop).
4. Press the Start / Stand-by button. End Time countdown starts. "..." Separator in the middle of displayed delay time flashes.



You can add or remove laundry within end time. Displayed time is the sum of normal drying time and end time. End Time LED will turn off at the end of countdown, drying starts and drying LED will illuminate.

### Changing the end time

If you want to change the duration during the countdown:

Cancel the program by turning the On/Off/Program selection knob. Select the program you want and repeat the End Time selection process.

Cancelling the end time function

If you want to cancel the end time countdown and start the program immediately:

Cancel the program by turning the On/Off/Program selection knob. Select the program you want and press the Dry/Time Level button.

## 5.6 Warning indicators



Warning indicators may vary depending on the model of your dryer.

### Filter cleaning

When the program is completed, the warning indicator for filter cleaning turns on.

## 5.7 Starting the program

Press the Dry/Time Level button to start the program.

Dry/Time Level and Drying indicators will illuminate to indicate that program started.

## 5.8 Child Lock

The drying machine has a child lock which prevents the program flow from being interrupted when the buttons are pressed during a program. When the child lock is activated, all buttons on the panel except the On/Off/Program selection knob are deactivated. Press the Buzzer button simultaneously for 3 buttons to activate the child lock.

The child lock has to be deactivated to be able to start a new program after the current program is finished or to be able to interfere with the program. To deactivate the child lock, keep the same button pressed for 3 seconds.



When the child lock is activated, the child lock warning indicator on the screen turns on.

Child lock deactivates when the drying machine is turned off and on by the On/Off/Cancel knob. When the drying machine runs and the child lock is active, it beeps twice when the program selection knob is turned. If the child lock is deactivated without returning the program selection knob to its previous position, program will terminate due to the change in the program selection knob position.

## 5.9 Changing the program after it is started

You can change the program you selected to dry your laundry with a different program after the drying machine starts running

- For instance, select Extra Dry program by turning the On/Off/Program selection knob to select Extra Dry instead of Iron Dry.
- Press the Dry/Time Level button to start the program.

## Adding and removing clothes during stand-by

If you want to add or remove clothes to/from the drying machine after the drying program starts:

- Press the Dry/Time Level button to put the drying machine in Stand-by state. The drying operation stops.
- Open the loading door while in Stand-by state, and close the door after you remove or add laundry.
- Press the Dry/Time Level button to start the program.



Adding laundry after the drying operation starts may cause the dried laundry inside the machine to mix with wet laundry and leave the laundry damp at the end of operation.

Adding or removing laundry during drying may be repeated as many times as you wish. But this operation continuously interrupts the drying operation, and thus increases program duration and energy consumption. So, it is recommended to add laundry before the program starts.

If a new program is selected by turning the program selection knob while the drying machine is in stand-by, the running program terminates.



Do not touch the inner surface of the drum while adding or removing clothes during a continuing program. The drum surface is hot.

## 5.10 Cancelling the program

If you want to cancel the program and terminate the drying operation for any reason after the drying machine starts running, turn the On/Off/Cancel knob, the program will be cancelled.



The inside of the drying machine shall be extremely hot when you cancel the program during machine operation, so run the refresh program to allow it to cool down.

## 5.11 End of program

When the program ends, the Fibre Filter Cleaning and Water Tank warning symbols on the program observation indicator turn on. Loading door may be opened and the dryer machine becomes ready for another run. Bring the On/Off/Program selection knob to On/Off position to turn the drying machine off.



If the laundry is not removed after the program is completed, the wrinkle prevention function activates for 2 hours to prevent the laundry inside the machine to get wrinkled. The program tumbles the laundry with 10-minute intervals to prevent them from wrinkling.

## 6 Technical Specifications

|   |   |
|---|---|
| Model                                       | Vented Dryer with electronic sensor control |
| Height (in)                                 | 33 1/4                                      |
| Width (in)                                  | 23 7/16                                     |
| Depth (in)                                  | 22 15/16                                    |
| Height adjustment of feet (in)              | 1 1/16                                      |
| Net weight (plastic front door usage) (lbs) | 69,7  |
| Net weight (glass front door usage) (lbs)   | 73,4  |
| Voltage / Frequency                         | 208-240V ~ 60 Hz                            |
| Connected load                              | 2000-2400 W                                 |
| Dry Load Capacity                           | 7kg / 15,5 lb                               |
| Capacity                                    | 3,8 cu-ft                                   |



This appliance's packaging material is recyclable. Help recycle it and protect the environment by dropping it off at recycling locations provided for this purpose. Your appliance also contains a large amount of recyclable material. It is marked with this label to indicate that used appliances should not be mixed with other waste. This way, the appliance recycling organised by your manufacturer will be done under the best possible conditions, in compliance with European Directive 2002/96/EC on Waste Electrical and Electronic Equipment. Contact your local government or your retailer for used appliance collection points closest to your home. We thank you for doing your part to protect the environment.

## 7 User maintenance and cleaning instructions

### 7.1 Lint filter

Lint and fibers released from the laundry in to the air during the drying cycle are collected in the "Lint Filter".



Fibres and lint are formed during wearing and washing.



**WARNING:** Always clean the filter after each drying cycle.

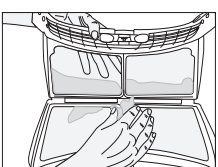
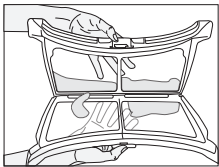
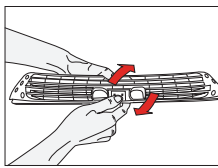
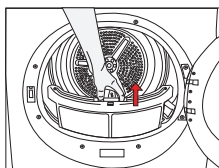

To clean the Filter;

1. Open loading door.
2. Remove the lint filter by pulling it up and open the filter.
3. Clean lint, fiber, and by hand or with a soft piece of cloth.
4. Close the filter and put it back in place.



You can clean the filter and filter area with a vacuum cleaner.



Clogging may arise on the filter surface after using your dryer for some time; if this occurs, wash the filter with water and dry it before using again.

### 7.2 Sensor

There are humidity sensors in your dryer that detect whether the laundry is dry or not.

For sensor cleaning;

1. Open loading door.
2. Allow dryer to cool off if drying has been done recently.
3. Wipe the metal sensors with a soft cloth dampened with vinegar and dry the sensors afterwards.

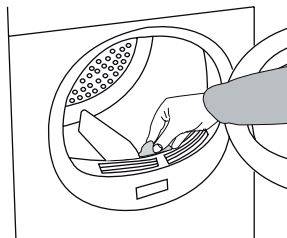

Clean the metal sensors at regular intervals (4 times a year).



**WARNING:** Never use solvents, cleaning agents or similar substances when cleaning as these might cause fire and/or an explosion!

## 8 Troubleshooting

| Problem  | Cause  | Explanation / Solution   |
|--|--|--|
| Drying process takes too long.   | *Lint filter may not have been cleaned.  | * Clean the lint filter.<br>* Meshes of the filter may be clogged. Wash with water.  |
|  | *Ventilation grids on the front side of the machine are blocked.   | *Remove the objects (if any) that block ventilation in front of the ventilation grids.   |
|  | *Ventilation is not sufficient since the room where the machine is installed is very small.  | *Open the door and window of the room to avoid the room temperature increase too much.   |
|  | *Lime deposit has built up on the dampness sensor  | *Clean the dampness sensor.  |
|  | *Excessive laundry is loaded.  | *Do not load the dryer in excess.  |
|  | *Laundry is not spun sufficiently  | *Spin your laundry at a higher speed in your washing machine.  |
| Dryer does not switch on or the program does not start. Dryer does not start when set. | * It may not plugged in.<br>* The loading door may be ajar.<br>* Program may not be set or the "Start/Pause/Cancel" button may not have been pressed.<br>* "Childproof lock" may be activated. | * Make sure that the dryer is plugged in.<br>* Make sure the loading door is properly closed.<br>* Make sure the program has been set and it is not in "Pause" mode.<br>* Deactivate the childproof lock.  |
| Program is interrupted for no reason.  | * The loading door may be ajar.<br>* Electricity may be cut off.   | * Make sure the loading door is properly closed.<br>* Press the "Start/Pause/Cancel" button to start the program.  |
| Laundry has shrunk, become felted or has deteriorated.                                 | * A program not suitable for the laundry type might have been used.  | * Dry only the laundry which is suitable for drying in the dryer. First check the labels on the clothes.<br>* Select a program a suitable low temperature setting for the laundry type to dry the clothes. |
| "End / Anticrease" LED flashes.  | * The 2-hour anti creasing program to prevent laundry from wrinkling may have been activated.  | * Turn off the dryer and take the laundry out of the dryer.  |
| "End / Anticrease" LED is on.  | * Program has come to an end.  | * Turn off the dryer and take the laundry out of the dryer.  |
| "Filter cleaning" LED flashes.   | * Lint filter may not have been cleaned.   | * Clean the lint filter.<br>* Meshes of the filter may be clogged. Wash with water.  |
| The "Drying" LED flashes.  | * A heat sensor failure has occurred. dryer ends the program without heating.  | * Turn off the dryer and remove the laundry. Call the authorized service.  |

**NOTE:** Call an authorized service if the problem persists.

## 9 Warranty Statement

### WARRANTY STATEMENT FOR THE BLOMBERG DRYERS

The warranties provided by Blomberg in these statements only apply to Blomberg dryers sold to the original purchaser or homeowner in the US and Canada. The warranty is not transferable. To obtain warranty service, please contact our nearest distributor as listed by state. You will need your dryer model number, serial number, retailer name and address, where purchased and purchase date / installation date. This warranty gives you specific legal rights, and you may also have other rights, which vary from state to state.

1 year \*\* limited warranty from date of first installation Blomberg will repair or replace at no cost to the consumer any defective parts of the dryer if used under normal household conditions (warranty is void if the product is used commercially e.g., bed + breakfast, nursing home etc.). Service must also be performed by an authorized Blomberg service agency. (Cosmetic defects must be reported within 10 business days from installation)

The accessories have 1 year warranty but not labor. Consumer is responsible for labor to install accessory.

2 year \* ++ limited warranty from date of first installation (Parts only) Blomberg will repair or replace any parts at no cost to the consumer if material defects or workmanship have caused the damage or failure of these components. Again the dryer must have been used under normal household conditions and not commercially as stated above (Labor charges are the responsibility of the consumer).

5 year \* ++ limited warranty from date of first installation (parts only 2-5 years) Blomberg will repair or replace any circuit boards or dryer drum (excluding any plastic attachments) at no cost to the consumer if material defects or workmanship have caused the damage or failure of these components. The dryer must have been used under normal household conditions and not commercially (Labor charges are the responsibility of the consumer).

Lifetime limited warranty from date of first installation +- (parts only) Blomberg will repair or replace to the original owner the stainless steel drum if rust through occurs under normal household use. Blomberg may, at its option, also replace the whole dryer with the same and/or equivalent model with equal or better functionality if the original model is no longer available. (Labor, removal and installation charges are the responsibility of the consumer.)

This product is fully tested and went through official quality assurance inspections before leaving the original manufacturing site. Warranty terms for this Blomberg household appliance is not valid if the product is altered, tampered, modified, additional parts assembled, fixed and re-packed by an authorized distributor, servicer, a third party retailer, reseller or by any other unauthorized person(s)

Disclaimers of warranties and exclusions:

Warranty does not cover service costs by an authorized service agent to correct installation, electrical and plumbing problems or educational instruction on the use of the dryer. The warranty also does not cover defects or damage caused by an act of god (such as storms, floods, fires, mudslides, etc.), damage caused by use of the dryer for purposes other than those for which it was designed, misuse, abuse, accident, alteration, improper installation, maintenance, travel fees, service calls outside normal service hours, unauthorized service work or servicers.

TO THE EXTENT PERMITTED BY LAW, THIS WARRANTY IS IN LIEU OF ALL OTHER EXPRESSED AND IMPLIED WARRANTIES, INCLUDING THE IMPLIED WARRANTIES OF MERCHANTABILITY AND FITNESS FOR A PARTICULAR PURPOSE. BLOMBERG UNDERTAKES NO RESPONSIBILITY FOR THE QUALITY OF THIS PRODUCT EXCEPT AS OTHERWISE PROVIDED IN THIS WARRANTY STATEMENT. BLOMBERG ASSUMES NO RESPONSIBILITY THAT THE PRODUCT WILL BE FIT FOR ANY PARTICULAR PURPOSE FOR WHICH YOU MAY BE BUYING THIS PRODUCT, EXCEPT AS OTHERWISE PROVIDED IN THIS WARRANTY STATEMENT.

Blomberg does not assume any responsibility for incidental or consequential damages. Such damages include, but are not limited to, loss of profits, loss of savings or revenue, loss of use of the dryer or any associated equipment, cost of capital, cost of any substitute equipment, facilities or services, downtime, the claims of third parties, and injury to property. Some states do not allow the exclusion or limitation of incidental or consequential damages, so the above limitations or exclusion may not apply to you.

\* Installation date shall refer to either purchase date or 5 business days after delivery of the product to the home, whichever is later.

++ Parts replaced will assume the identity of the original parts + their original warranty.

There are No Other Warranties. This Warranty Statement is the complete and exclusive warranty from the manufacturer. No employee of Blomberg or any other party is authorized to make any warranty statements in addition to those made in this Warranty Statement.

### HOW TO GET SERVICE

Please contact the Distributor for your State or Province as listed on the Distributor Contact List, or call our Toll Free Number at 1 800 459 9848 for direction to an Authorized Blomberg Service Agent or contact via <http://www.blombergappliances.com>









**Blomberg®**

**seit 1883**

[www.blomberginternational.com](http://www.blomberginternational.com)  
[info@blomberginternational.com](mailto:info@blomberginternational.com)