



OPERATING INSTRUCTIONS

Dishwasher

EN

DFI675XXL.U

Contents

Your dishwasher	3	Status light™	19
Welcome to our growing ASKO family!	3	Stopping or changing a program	20
Important safety instructions	4	If you want to load more dishes	20
General	4	If the dishwasher is turned off due to a power failure	20
Child safety	5	Once the program has finished	20
Activate child lock (Kid Safe™)	5	How to get the best drying results	20
Installation	5	Unloading the dishwasher	20
Winter storage/Transport	5	Program chart	22
Overflow guard function	5	Settings	23
Packing material	5	Open the dishwasher's Settings menu	23
Disposal	5	Care and maintenance instructions	25
Before washing for the first time	7	Add rinse aid	25
1. Water hardness	7	Cleaning the filters	25
2. Basic settings	7	Cleaning the spray arms and spray pipes ...	26
Greener dishwashing	9	Clean the dishwasher inside and out	27
The dishwasher saves energy and water	9	Remove blockages	28
Loading the dishwasher	10	Troubleshooting	29
Fragile dishes	10	Installation instructions	35
Loading affects the results	10	Important safety instructions	35
The baskets	10	Setup	35
Upper basket	11	Drain connection	36
Middle basket	12	Connection to water supply	37
Lower basket	12	Electrical connection	37
Cutlery basket	13	Service	39
Typical load	14	Limited Warranty – Residential Appliances ...	39
Using the dishwasher	16	Items excluded from warranty	39
Add detergent	16	Disclaimer	39
The main power switch	17	ASKO Customer Care	40
Select program	17	Service after expiration of limited warranty ...	40
Select program mode	18	Technical information	41
Select option	18	Technical data	41
Starting the dishwasher	19		
Time remaining	19		

Welcome to our growing ASKO family!

We are proud of our appliances. We want them to help make the world a better place – improving the quality of life for you and your loved ones. We hope that this appliance will be an appreciated and dependable device for many years to come.

Please read the operating instructions before use. They include general tips, information about the settings and adjustments you can make, and how best to care for your appliance.

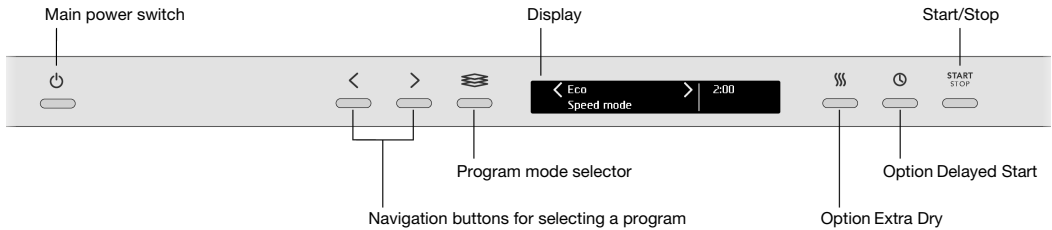

Install the dishwasher, see the chapter *Installation instructions*. Following this, open the door and press the main power switch to start using the machine.

"Welcome to your new ASKO. This is a first time set up." is shown on the display the first time the dishwasher is switched on. It is important that you choose the right settings to ensure good dishwashing results. See page 7.

Important safety instructions

SAVE THESE INSTRUCTIONS FOR FUTURE REFERENCE

WARNING!

When using your dishwasher, follow basic precautions, including the following:

- Read all instructions before using the dishwasher.
- Use the dishwasher only for its intended function.
- Use only detergents or wetting agents recommended for use in a dishwasher and keep them out of the reach of children.
- When loading items to be washed:
 - locate sharp items so that they are not likely to damage the door seal, and
 - load sharp knives with the handles up to reduce the risk of cut-type injuries.
- Do not wash plastic items unless they are marked “dishwasher safe” or the equivalent. For plastic items not so marked, check the manufacturer’s recommendations.
- Do not operate the dishwasher unless all enclosure panels are properly in place.
- Do not tamper with controls.
- Do not abuse, sit on, or stand on the door or dish rack of the dishwasher.
- To reduce the risk of injury, do not allow children to play in or on a dishwasher.
- Under certain conditions, hydrogen gas may be produced in a hot water system that has not been used for two weeks or more. HYDROGEN GAS IS EXPLOSIVE. If the hot water system has not been used for two weeks, before using the dishwasher turn on all hot water faucets and let the water flow from each for several minutes. This will release any accumulated hydrogen gas. As the gas is flammable, do not smoke or use an open flame during this time.
- Remove the door to the washing compartment when removing an old dishwasher from service or discarding it.
- Read the grounding instructions in the installation instructions.

General

- Do not run the dishwasher while you are out of the home.
- Do not store or use combustible materials, gasoline, or other flammable vapors and liquids in the vicinity of this or any other appliance.
- Disconnect electrical power to dishwasher before servicing.
- Repairs should be done by a qualified technician.

WARNING!

PROPOSITION 65 FOR CALIFORNIA RESIDENTS

Cancer and Reproductive Harm – www.P65Warnings.ca.gov

Important safety instructions

Child safety

- Always keep small children away from the machine when it is open. There may be some detergent residue left inside the machine.
- Always close the door and start the dishwasher as soon as you put in the detergent.
- If dishwasher detergent gets in someone's eyes, rinse them with plenty of water for at least 15 minutes.
- Should a child swallow dishwasher detergent or rinse aid, give plenty to drink immediately, i.e., one or two glasses of milk or water. Do not try to induce vomiting. Seek medical advice immediately: Call the National Capital Poison Center at 1-800-222-1222.

WARNING!

Dishwasher detergents and rinse aids are corrosive, so always keep them out of reach of children.

Activate child lock (Kid Safe™)

You can activate the child lock (button lock) to prevent children from starting the dishwasher. See the chapter *Settings*.

Installation

See the chapter *Installation instructions*.

Winter storage/Transport

Store the dishwasher above freezing and avoid long transport distances in very cold weather. Transport the dishwasher upright or laying on its back.

Overflow guard function

The overflow protection starts pumping out the machine and turns off the water supply if the water level in the dishwasher exceeds the normal level. If the overflow protection is triggered, Overflowing water appears on the display. Turn off the water supply and contact your nearest service center.

Packing material

The outer packaging protects the product during transport. The packaging material is recyclable. Separate the different packaging materials to help reduce raw material use and waste. Your dealer can take the packaging for recycling or direct you to the nearest recycling center. The packaging is comprised of:

- Corrugated cardboard made from up to 100% recycled material.
- Expanded polystyrene (EPS) with no added chlorine or fluorine.
- Supports made from untreated wood.
- Protective plastic made from polyethylene (PE).

Disposal

The dishwasher is manufactured and labeled for recycling.

When the machine has reached the end of its service life and is to be disposed of, it should immediately be made unusable. Pull out the power cable and cut it as short as possible.

Important safety instructions

Contact your municipality for information about where and how your dishwasher can be recycled correctly.

Before washing for the first time

1. Water hardness

In order to achieve good dishwashing results, the dishwasher needs soft water (water with low mineral content). Hard water leaves a white coating on dishes and the dishwasher.

Contact the local water utility to check the water hardness in your area. This is important to determine how much detergent and rinse aid to use.

In general, more rinse aid and detergent are needed for hard water.

2. Basic settings

Open the door and press the main power switch.

"Welcome to your new ASKO. This is a first time set up." is shown on the display. It is important that you choose the right settings to ensure good dishwashing results.

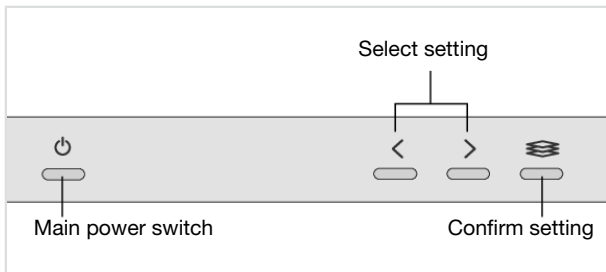

Settings

1. Language

Select the language to be shown on the display.

2. Rinse aid 0/1/2/3/4/5

Use rinse aid to improve wash and dry times. Also use rinse aid to achieve clear and spotless results. Select rinse aid dosage. The rinse aid dispenser can be adjusted between 0 (Off) and 5 (High dosage).

Pre-selected at factory: 5

👉 Add rinse aid

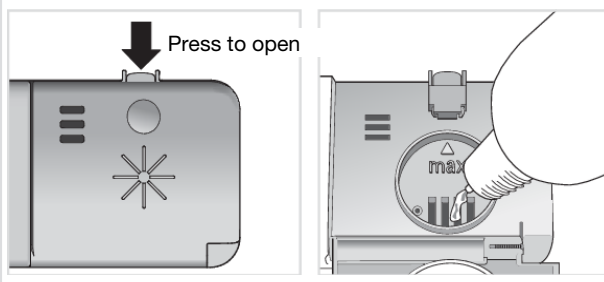

Before washing for the first time

Add rinse aid

1. Open the rinse aid compartment lid.
2. Carefully top up with rinse aid to the level marked **max**.
3. Wipe up any spilled rinse aid around the compartment.
4. Close the lid firmly.

To change the chosen setting, see the chapter Settings.

The dishwasher saves energy and water

When using a dishwasher in a residential setting, less energy and water are generally used compared to washing the dishes by hand.

Do not rinse under running water

Do not rinse the dishes under running water as this will lead to increased energy and water consumption. Simply scrape off large food particles before loading the dishwasher.

Choose a green detergent

Read the environmental declaration on the packaging!

Too much detergent and rinse aid can result in less effective dishwashing and lead to a greater environmental impact.

Run a fully loaded dishwasher

Save energy and water by waiting until the dishwasher is full before running a program. Use the Rinse and hold program to rinse the dishes if there are any unpleasant odors.

Run programs at a lower temperature

If the dishes are only lightly soiled, you can select a program with a low temperature.

Select dishwashing program – Eco

This program is the most effective in terms of energy consumption.

Select program mode – Green mode

The dishwasher has different program modes. To save energy and water, use Green mode. (Available with: Normal , Light)

Open the door a little once the program has finished

Better drying results are achieved if you open the door a little once the program has ended. (If the dishwasher is built-in, the surrounding furnishings must be resistant to any condensation from the dishwasher.)

Connect to cold water

Connect the dishwasher to the cold water supply if the building is heated using oil, electricity, or gas.

Connection to hot water supply

Connect the dishwasher to the hot water supply (max. 160 °F (70 °C)) if the building is heated using an energy-efficient means such as district heating, solar power, or geothermal power. Choosing a hot water connection cuts dishwashing times and reduces the dishwasher's energy consumption.

NOTE!

Do not exceed the permitted water supply temperature. Certain materials used in some cookware cannot withstand strong heat.

Loading the dishwasher

Fragile dishes

Some cookware is not dishwasher safe. This can be for several reasons. Some materials cannot withstand high temperatures, others can be damaged by dishwasher detergent.

Use caution with, for example, handmade items, fragile decoration, crystal/glassware, silver, copper, tin, aluminum, wood, and plastic. Look for the "Dishwasher safe" marking.

Fragile decoration

Porcelain with decoration on top of the glazing (the items feel rough) should not be washed in a dishwasher.

Crystal/Glass

Wash fragile items made of crystal/glass, such as crystal glass from Orrefors, using the gentle dishwashing program Crystal. Remember to use a small amount of detergent and to place items so that they do not touch each other during the wash.

Use rinse aid to improve wash and dry times. Also use rinse aid to achieve clear and spotless results.

Hand-painted glassware, as well as antique and very fragile items, should not be washed in a dishwasher.

Silver

Silver and stainless steel items should not come into contact, as the silver can become discolored.

Aluminum

Aluminum can lose its shine if washed in a dishwasher. However, good quality aluminum pans can be washed in a dishwasher, even if some of the shine will be lost.

Cutlery with glued handles

Some types of glue are not dishwasher safe. In such cases, the handles may loosen.

Loading affects the results

Load the dishes carefully to ensure the best washing and drying results with the lowest possible energy and water consumption. Give your dishwasher the best chance to reach and clean all surfaces, as well as to dry the dishes as thoroughly as possible.

- All dirty surfaces should face in and down!
- Dishes should not be placed in or on each other.
- Angle dishes with hollows, such as cups, so that the rinse water will run off. This is also important for plastic items.
- Place the upper basket in its highest position when dishwashing very large plates.
- Make sure small items cannot fall through the dishwasher basket; place them in the cutlery basket.

NOTE!

Check that the spray arms can rotate freely.

The baskets

The dishwasher includes an upper, a lower, and a cutlery basket.

The basket appearance may differ depending on the configuration.

Loading the dishwasher

Upper basket

Place glasses, cups, bowls, side plates, and saucers in the upper basket. Place all soiled surfaces down! Place wine glasses on the wine glass shelf. Place knives in the knife stand on the right.

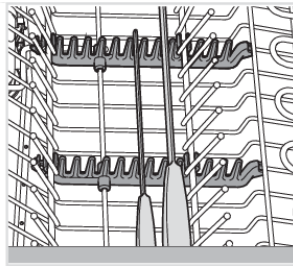
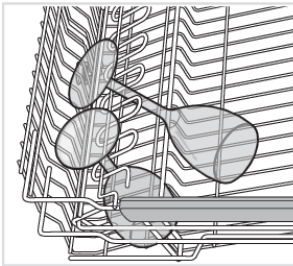
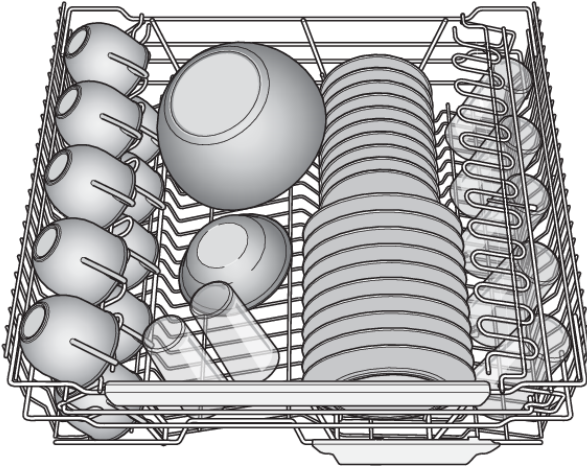

Foldable tines

The foldable tines can be folded up or down to make it easier to load pots, bowls, and glasses. Release the foldable tines by pressing the catch inward before adjusting their position.

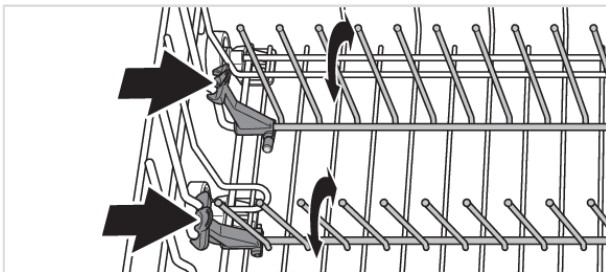

Raising the upper basket

1. Pull out the upper basket.
2. Grab the sides of the upper basket with both hands and lift it up.

Loading the dishwasher

Lowering the upper basket

1. Pull out the upper basket.
2. While holding the basket, pull out the two locking handles on either side to lower the upper basket.

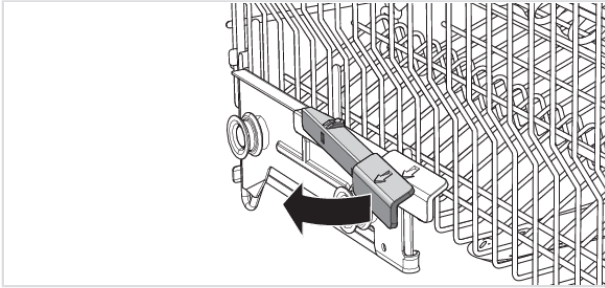

Middle basket

The middle basket with the spray pipe is suitable for low items.

The middle basket's utensils basket has space for ladles, whisks, serving cutlery and similar items.

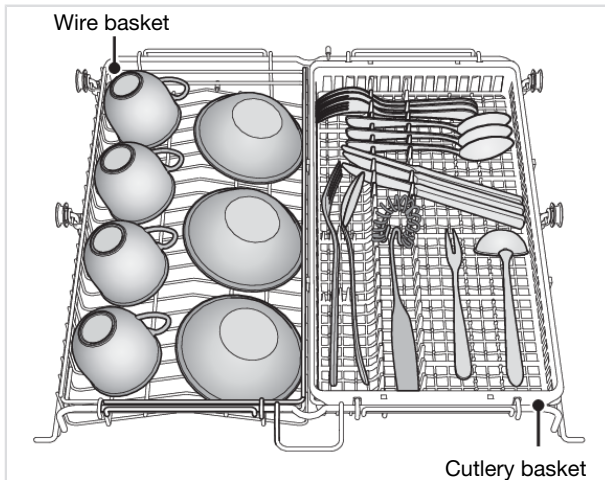

Washing larger items

The two baskets in the middle basket can be removed, or the entire middle basket can be removed, to create more space between the upper and lower baskets if larger items are being washed.

Lower basket

Place plates, side plates, serving dishes, pots, and cutlery (in the cutlery basket) in the lower basket.

Place pots and pans in the right rear of the lower basket for the best cleaning results from the two rear spray nozzles (WideSpray™), which are intended for these types of dishes.

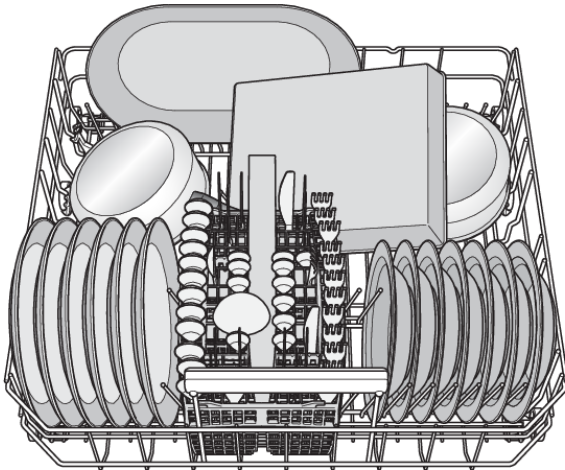

Foldable tines

Lower the foldable tines when washing large pots. Release the foldable tines by pressing the catch inward before adjusting their position. In the rear right part of the lower basket, half of the foldable tines can be folded when washing, for example, stoneware or a large pan.

Vase and bottle holder

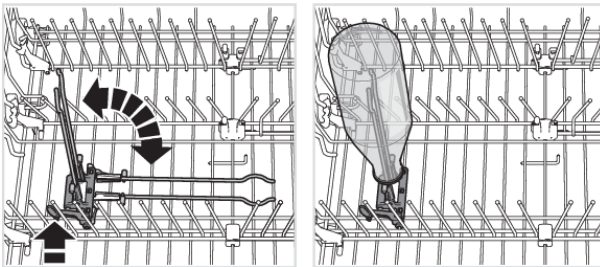

Washing large plates

Move adjustable tines and their mounts to widen the distance between the tine rows to adapt the lower basket to plates with a diameter greater than 9 3/4" (25 cm).

Cutlery basket

Place cutlery with the handles facing down, except for knives, and spread them out as much as possible. Ensure that spoons do not stack inside each other.

The cutlery basket is best placed in the middle at the front of the lower basket to best utilize dishwashing performance from the unique spray nozzle (Power Zone Cutlery™), which is intended for the cutlery basket.

Loading the dishwasher

⚠ WARNING!

Knives and other pointed items must be placed with the points down in the cutlery basket or horizontally in other baskets.

Fold-down section for small items

The cutlery basket has a fold-down section in the middle for small items, or small shafts, such as electric whisk attachments.

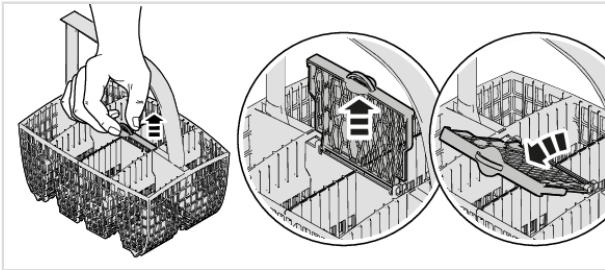

Typical load

Recommended for daily, regular, or typical use.

Upper basket

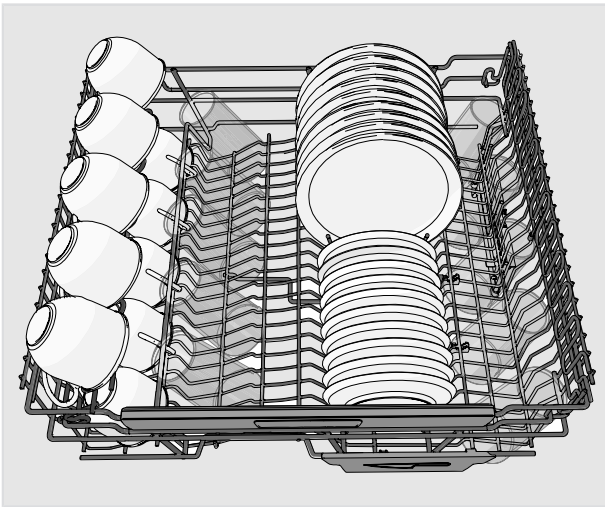

NOTE!

Ensure the upper basket is set to its lowest position.

Lower basket

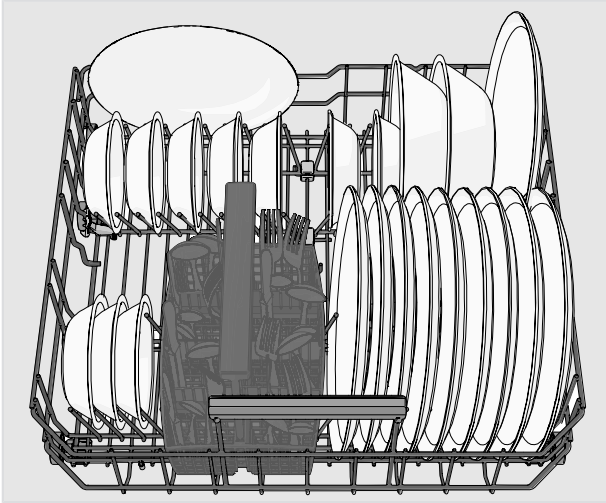

Using the dishwasher

Add detergent

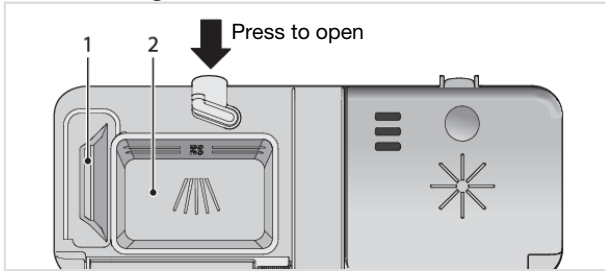

1. Prewash detergent compartment
2. Main wash detergent compartment

Detergent is added according to water hardness.

Follow the instructions on the detergent packaging.

Too much detergent can result in less effective dishwashing and also entails greater environmental impact.

The detergent compartment must be dry when adding detergent. There is one compartment for the prewash and one for the main wash. If powder or liquid dishwasher detergent is used, add a small amount of the detergent to the prewash compartment. Contact the detergent manufacturer if you have questions about the detergent.

NOTE!

Use only dishwasher detergent! Liquid hand-washing detergent must not be used as the foam that forms prevents the dishwasher from operating effectively.

Dishwasher tablets

Halve the tablet if it is difficult to close the dispenser lid. There is a risk that the detergent will not be released properly if the lid is tight and cannot open correctly.

NOTE!

Dishwasher tablets are not recommended for short programs (less than 75 minutes). Use powder or liquid dishwasher detergent instead.

All-in-one detergent

There are many types of all-in-one detergents on the market. Read through the directions for these products carefully.

NOTE!

Optimal washing and drying results are achieved by using normal dishwasher detergent together with separately dispensed rinse aid.

Using the dishwasher

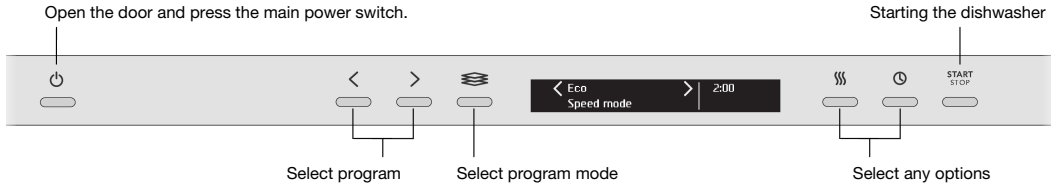

The main power switch

Open the door and press the main power switch. Also turn on the water supply valve if it is turned off.

Select program

Select a program to suit the type of dishes and how dirty they are.

Normal

This program is recommended for daily, regular, or typical use to completely wash a full load of normally soiled dishes, such as plates, serving dishes, cups, and glasses.

Eco

This program is the most effective in terms of energy consumption.

You can read more about greener dishwashing in the chapter *Greener dishwashing*.

Auto

The dishwasher can measure how dirty the dishes are and adjust water consumption and temperature accordingly. When newly installed, the program needs to be run five times before it is fully adapted and can provide the best results.

Light

An effective program for slightly dried leftovers. (This program is not intended for burnt food, such as on oven dishes.)

Time

The program adapts to the specified running time or finish time. With this program, it is important to choose a time suited to how dirty the dishes are.

0:15-0:45	Lightly soiled dishes
1:00-1:30	Normally soiled dishes
2:00-2:30	Heavily soiled dishes

Press the  option button to set the desired program time.

Rinse and hold

Use to rinse dishes while you wait for the dishwasher to become fully loaded.

Using the dishwasher

Plastic

A program intended for washing plastic items that are dishwasher safe. This program has an extra long drying cycle. Porcelain and glasses can also be washed.

Sanitize

This program is recommended for baby bottles and cutting boards when additional sanitation is required. The temperature is high in the main wash and in the final rinse.

Crystal

A gentle dishwashing program with a low temperature for washing fragile items made of crystal/glass, such as crystal glass from Orrefors. Remember to use a small amount of detergent and to place items so that they do not touch each other during the wash. See also *Fragile dishes* in the chapter *Loading the dishwasher*. Porcelain that has just been used without dried leftovers can also be washed using this program.

Self-cleaning

Self-cleaning program for sanitizing the dishwasher tub, spray arms, and spray pipes.

This program should be run (with no dishes in the machine) using regular dishwasher detergent or citric acid. Special dishwasher cleaners are also available in stores. For the removal of limescale deposits, see *Dishwasher tub* in the chapter *Care and maintenance instructions*.

Upper half

You can use this program if you only have cups and glasses that need washing in the upper basket. Lightly soiled dishes can also be placed in the lower basket.

Lower half

You can use this program when you only want to wash plates and cutlery in the lower basket. Lightly soiled dishes can also be placed in the upper basket.

Select program mode

To select a program mode, press the program mode selector until the desired mode is shown on the display. The available program modes vary between programs.

Green mode

The dishwasher uses less energy and water. The program time is extended.

Speed mode

The program time is shortened, but the dishwasher uses more energy.

Night mode

Lower noise level during the dishwashing program. The program time is extended.

Intensive mode (Heat Boost)

The higher temperature dissolves grease on very dirty dishes, but the dishwasher consumes more energy and water. The program time is extended.

Select option

To select an option, press the option button until the desired option is shown on the display. The available options vary between programs.

Extra Dry (Heated drying option)

The Extra Dry option improves the drying results by using a longer drying cycle and a higher temperature in the final rinse. Energy consumption is slightly increased.

The Extra Dry option is pre-selected for some programs. You can deactivate this option to save time and energy.

Delayed Start

When you select Delayed Start, the dishwasher will start 1-24 hours after you have pressed the button Start/Stop and closed the door.

1. Press the button once to activate Delayed Start. Press the button several times – or hold it in – to set the desired number of hours.
2. Press Start/Stop and close the door. The timer counts down and the dishwasher starts after the selected delay.

If you want to cancel the Delayed Start option, open the door then press and hold Start/Stop for three seconds.

START **STOP** Starting the dishwasher

Press Start/Stop until the display shows "Program started, close door in 4 sec". This indicates that the dishwasher is ready to start. Close the door properly within four seconds, otherwise the dishwasher will not start.

If the dishwasher is not started or the door is not closed within 2 minutes of the last button press, the machine switches off.

Time remaining

Once you have chosen a program, program mode, and options, the time the program took when last used is displayed.

Status light™

The status light at the bottom on the dishwasher provides information by means of 3 different colors.

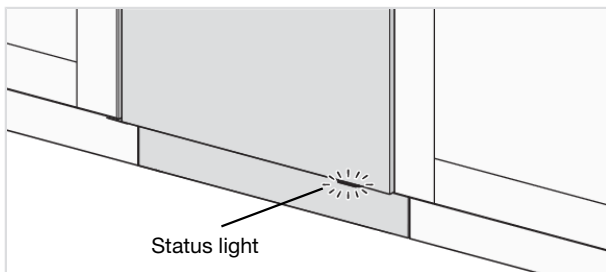

Blue - Load more

The program has started, but you can still load more dishes.

Red - Do not load

You should not load more dishes (can result in poor dishwashing).

A flashing light indicates that the door has been opened while a program is in progress. If it flashes when the door is closed, an error has occurred. See the chapter Troubleshooting.

Green - Unload

The dishwashing program is finished. The status light stays on for 15 minutes.

Using the dishwasher

Stopping or changing a program

If you want to change the program after starting the dishwasher, open the door then press and hold Start/Stop for three seconds. Add more detergent if the lid of the detergent dispenser has opened. Then choose a new program, press Start/Stop, and close the door within four seconds.

If you want to load more dishes

Open the door. The dishwasher stops automatically. Add the dishes. Press Start/Stop and close the door within four seconds.

WARNING!

If the door is open, "Program paused" is shown on the display. If you want the dishwashing program to continue, press Start/Stop and close the door immediately. If you want to cancel the dishwashing program, press and hold Start/Stop for three seconds.

If the dishwasher is turned off due to a power failure

If the program was not finished, the interrupted program resumes when power is restored.

NOTE!

During drying, the program is interrupted if the power is cut or the door is open for more than 2 minutes.

Once the program has finished

The end of the program is indicated by one short signal from the buzzer. The chapter *Settings* describes how to change this function.

Moreover, the end of the program is indicated by the status light turning green.

The dishwasher switches off automatically after the program ends.

To minimize the risk of leaks, we recommend that you turn off the water supply valve if away from home for an extended period of time.

How to get the best drying results

- Fully load the dishwasher.
- Angle dishes with hollows, such as cups, so that the rinse water will run off. This is also important for plastic items.
- Top up with rinse aid or increase the rinse aid dosage level.
- Activate the Extra Dry option.
- Open the door a little once the program has finished.
- Allow the dishes to cool before unloading the dishwasher.

Unloading the dishwasher

Hot porcelain is more fragile. Leave the dishes to cool in the dishwasher before unloading them.

Using the dishwasher

Unload the lower basket first to avoid any water drops from the upper basket falling onto the dishes in the lower basket.

Using the dishwasher

Program chart

Program	Detergent compartment 2 (ml)	Program mode / Option	Prewashes	Main wash	Number of rinses	Final rinse	Consumption values 1)				
							Cold water 2)		Hot water 3)		Water cons. (gallon)
							Dishwashing time (approx. hrs:min)	Energy (approx. kWh)	Dishwashing time (approx. hrs:min)	Energy (approx. kWh)	
Normal ⁴⁾	25		2	53 °C 127 °F	2	55 °C 131 °F	2:10	1.0	1:50	0.5	3.2
Eco	25		2	50 °C 122 °F	3	50 °C 122 °F	3:10	0.8	2:50	0.4	3.3
Auto	25		2-3	50-65 °C 122-149 °F	2-3	65 °C 149 °F	2:40-3:20	1.0-1.6	2:20-3:00	0.6-1.2	3.7-5.3
Light	25		2	60 °C 140 °F	2	65 °C 149 °F	2:20	1.2	2:00	0.8	3.8
Time	25		0-2	<65 °C <149 °F	2-3	<65 °C <149 °F	0:15-2:30	0.5-1.4	0:15-2:30	0.4-1.0	2.4-4.6
Rinse and hold					1	--- °C --- °F	0:07	0.01	0:07	0.01	0.9
Plastic	25		1	55 °C 131 °F	2	68 °C 154 °F	3:10	1.1	2:50	0.7	3.0
Sanitize	25			70 °C 158 °F	2	68 °C 154 °F	1:30	1.3	1:10	0.9	2.6
Crystal	20			45 °C 113 °F	2	50 °C 122 °F	1:50	0.7	1:30	0.4	2.3
Self-cleaning				70 °C 158 °F	2	70 °C 158 °F	1:25	1.0	1:05	0.6	2.4
Upper half	20		1	65 °C 149 °F	2	60 °C 140 °F	2:25	1.0	2:05	0.6	3.2
Lower half	20		1	65 °C 149 °F	2	60 °C 140 °F	2:25	1.0	2:05	0.6	3.2

1) Consumption values vary depending on the temperature of the incoming water, room temperature, load size, selected additional functions, and more.

2) Connection to cold water, approx. 50 °F (10 °C). (A cold water supply is recommended.)

3) Connection to hot water, approx. 120 °F (60 °C).

4) The energy label performance figures are based on this program. This program is recommended for daily, regular, or typical use to completely wash a full load of normally soiled dishes, such as plates, serving dishes, cups and glasses.

Open the dishwasher's Settings menu

To open the dishwasher's Settings menu, press the Navigation button < or > until Settings menu is shown on the display and confirm your selection with the mode selector .

To exit the dishwasher's Settings menu, select Exit and confirm your selection with the mode selector .

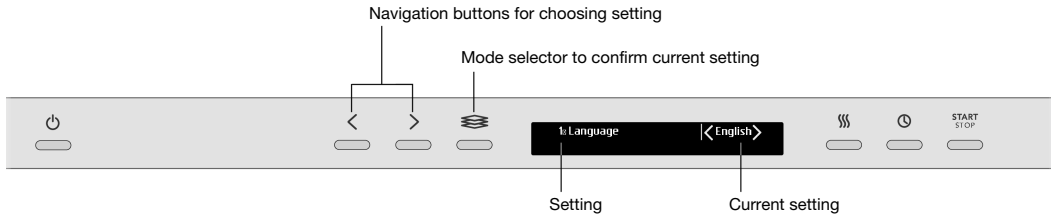

Settings	Alternatives	
1. Language	English US/Svenska/ Dansk/Norsk/Suomi/ Nederlands/Français/ Deutsch/Italiano/Русский/ Español/Português/ Sloven./Eesti/Latviešu/ Lietuvių/Hrvatski/Polish/ 简体中文 / 繁體中文 / 日本語	You can choose the language used for the display.
2. Select programs	Normal On/Off Eco On/Off Auto On/Off Light On/Off Time On/Off Rinse and hold On/Off Plastic On/Off Sanitize On/Off Crystal On/Off Self-cleaning On/Off Upper half On/Off Lower half On/Off	Programs can be shown or hidden in the menu. Choose between On and Off. (Eco cannot be hidden in the menu.)
3. Child lock	On/Off	You can activate the child lock (button lock) to prevent children from starting the dishwasher. <🕒 To temporarily deactivate and activate the child lock, press and hold the left Navigation button and the option button Delayed Start for 3 seconds.

Settings

Settings		Alternatives	
4.	Display settings	Contrast top display 1/2/3/4	For adjusting the contrast of the display.
		Logo in top display <i>On/Off</i>	Setting to hide the logo shown on the display.
5.	Feedback sound	0/1/2/3	This sound is used to confirm each button press.
6.	Buzzer volume	0/1/2/3	The buzzer indicates when a dishwashing program has ended. <i>Error messages are always indicated by a loud buzzer.</i>
7.	Rinse aid △	0/1/2/3/4/5	Setting for rinse aid dosage. The rinse aid dispenser can be adjusted between 0 (Off) and 5 (High dosage). Increase the rinse aid dosage: <ul style="list-style-type: none"> If the dishes have water marks. Reduce the rinse aid dosage: <ul style="list-style-type: none"> If the dishes have a sticky white/blue film. If the dishes are streaked. Heavy foaming. If you have very soft water, the rinse aid can be diluted 50:50 with water.
8.	Super rinse	<i>On/Off</i>	Super rinse adds two extra rinses. <i>Activated in the following programs:</i> <i>Normal</i> <i>Eco</i> <i>Light</i> <i>Plastic</i> <i>Upper half</i> <i>Lower half</i>
9.	Interior light at power off	<i>On/Off</i>	Select whether the interior light is to be switched on when the dishwasher is turned off and the door is opened. (If the main power switch is turned on, the interior light is always switched on when the door is opened.)
	Exit		To exit the dishwasher's Settings menu, select Exit and confirm your selection with the mode selector  .

Care and maintenance instructions

Add rinse aid

When the rinse aid needs topping up, the above symbol lights on the display.

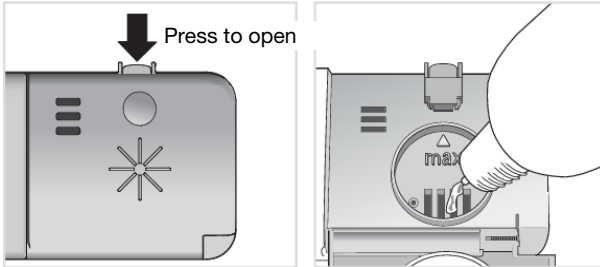

1. Open the rinse aid compartment lid.
2. Carefully top up with rinse aid to the level marked **max**.
3. Wipe up any spilled rinse aid around the compartment.
4. Close the lid firmly.

After topping up, it may take a while before the symbol goes out.

Cleaning the filters

Coarse filter

The coarse filter traps larger food particles, which cannot get past the drain pump. Empty the coarse filter when necessary. It should be cleaned at regular intervals depending on how often the dishwasher is used.

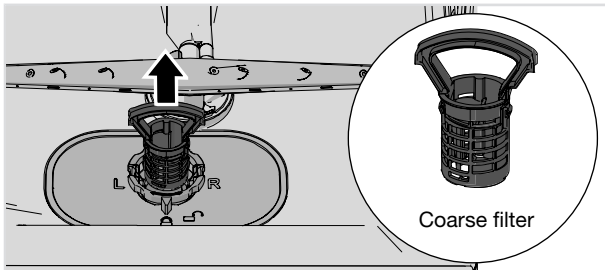

1. Lift the coarse filter by the handle.
2. Empty the coarse filter.
3. Refit the coarse filter. Press it down until it clicks into place.

Fine filter

Debris that collects on the fine filter is automatically rinsed away during each wash. Clean the fine filter when necessary. It should be cleaned at regular intervals depending on how often the dishwasher is used.

Care and maintenance instructions

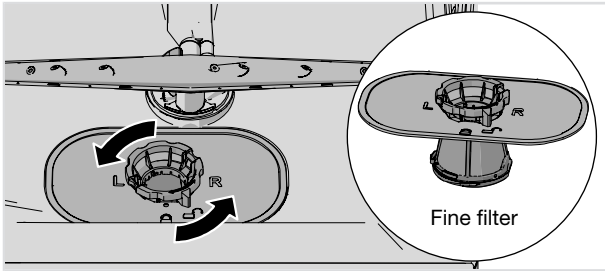

1. Turn the locking ring counterclockwise and lift the fine filter straight up.
2. Clean the fine filter.
3. Refit the fine filter and turn the locking ring clockwise to its stop position. Check that the edges seal properly.

Remember to refit the coarse filter!

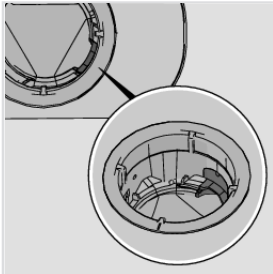

Check that the colored stop on the right in the bottom drain is in place.

NOTE!

Dishwashing results may be affected if the coarse and fine filters are incorrectly fitted. The dishwasher must not be used without the filters in place!

Cleaning the spray arms and spray pipes

Holes and bearings can become blocked. Remove debris using a needle or similar item. The spray arms have holes on the bottom.

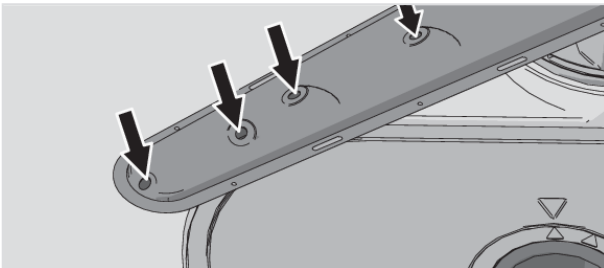

Spray arms can be removed for cleaning. Remember to fit them firmly back into place afterward.

Care and maintenance instructions

Upper spray arm

1. Pull out the upper basket.
2. Unscrew the spray arm bearings counterclockwise to remove the spray arm from the upper basket.

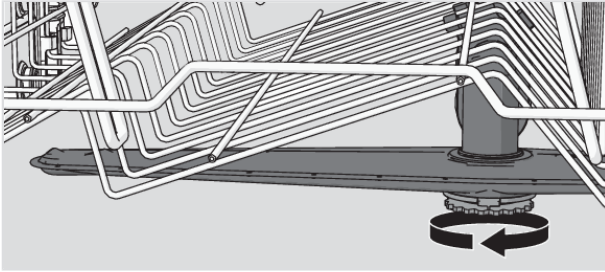

The middle spray pipes

- Pull out the middle basket.
- Check the holes in the spray pipes.

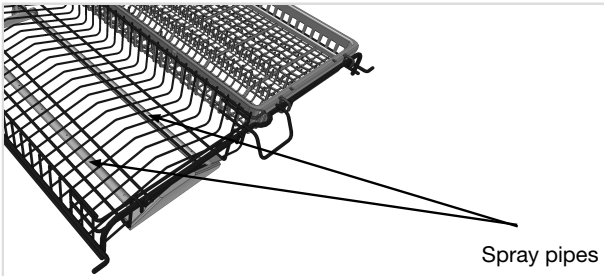

Lower spray arm

- Pull the lower spray arm straight up to release it.

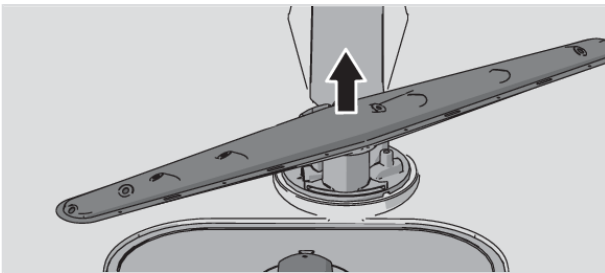

Clean the dishwasher inside and out

Door and door seal

Open the door. Clean the sides of the door and the door seal regularly with a slightly damp cloth. Clean the door seal at the lower front edge of the dishwasher with a washing-up brush.

Care and maintenance instructions

Display and buttons

Keep the display and the buttons clean. If necessary, wipe them with a dry or slightly damp cloth. Never use cleaning products – they may scratch the surface.

Use the main power switch to switch off the dishwasher when cleaning the buttons to avoid activating them inadvertently.

Dishwasher tub

The dishwasher tub is made of stainless steel and is kept clean through normal use (when used regularly).

If you have hard water, limescale deposits may build up in the dishwasher. If this happens, run the Self-cleaning program with two tablespoons of citric acid in the detergent compartment (with no dishes in the machine). Special dishwasher cleaners are also available in stores.

Never use anti-freeze, Draino®, CLR®, or other chemical cleaners.

Remove blockages

Unblocking the drain pump

If the dishwasher still contains water after the program has finished, something may be blocking the drainage pump. Such blockages are easily removed.

1. Turn off the machine using the main power switch and unplug it from the power outlet.
2. Remove the coarse filter and the fine filter.
3. Scoop out the water from the dishwasher tub.
4. In order to inspect the drain pump, remove the colored stop on the right in the bottom drain.
5. Turn the pump wheel located behind the drain pump stop by hand. Carefully remove any items.
6. Reinstall the drain pump stop along with the fine and coarse filters.
7. Plug the machine in again.

If the dishwasher still does not start and a whirring sound is heard, the overflow protection has been triggered.

- Shut off the water.
- Unplug the unit from the power outlet.
- Call the Customer Care Center.

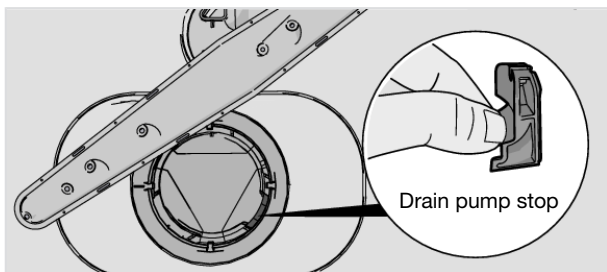

NOTE!

Do not forget to reinstall the drain pump stop.

Type of fault on the display		Action
F10	Overfilling water 1	Clear the drain pump. See the chapter <i>Care and maintenance instructions</i> . If the problem persists, call the Customer Care Center.
F11	Water outlet fault	See "Water remains in the dishwasher above the filters" in the table "Problem" below. If the problem persists, call the Customer Care Center.
F12	Water inlet fault	Check that the water supply valve is on. If the problem persists, call the Customer Care Center. The water pressure should be 4.2-140 psi.
F40	Inlet valve leakage	Turn off the water supply valve and call the Customer Care Center.
F52	Clean the filters (Water level fault)	Clean the coarse and fine filters. If the problem persists, call the Customer Care Center.
F54	Overfilling water 2	Turn off the water supply valve and call the Customer Care Center.
F56	Circ. pump fault	Call the Customer Care Center.
F67	Water inlet fault	Check that the water supply valve is on. If the problem persists, call the Customer Care Center. The water pressure should be 4.2-140 psi.

Press any button to clear the error message.

Problem	Possible causes	Action
The buttons do not react when pressed.	You have pressed the buttons too soon after opening the door.	Wait a moment then try again.
	Child lock (button lock) activated.	See the chapter <i>Settings</i> .
	The door is closed.	Open the door. The buttons only react to use when the door is open.
	The buttons are dirty.	Clean with a dry or slightly damp cloth.
Cannot close door.	The baskets are not correctly positioned.	Check that the baskets are correctly positioned horizontally, and that the middle basket's water connector is in line with its spray pipe.
		Check that the dishes are not blocking the baskets from sliding properly into place.

Troubleshooting

Problem	Possible causes	Action
The dishwasher does not start.	The Start/Stop start button has been pressed for too short a time.	Press and hold Start/Stop until the display shows "Program started, close door in 4 sec".
	The door is not closed properly or was not closed immediately after pressing the Start/Stop button.	Close the door within four seconds, otherwise the dishwasher will not start.
	You have opened the dishwasher to add more dishes while a program is in progress.	If you want the dishwashing program to continue, press Start/Stop and close the door within four seconds.
	A fuse/circuit breaker has been tripped.	Check.
	The plug is not plugged into the power outlet.	Check.
	The water supply valve is turned off.	Check.
	Overflow/leaks.	Check.
	A whirring sound (the drain pump) is heard from the dishwasher and does not stop when the main power switch is turned off.	Turn off the water supply valve. Pull out the plug and call the Customer Care Center.
	Check that the Delayed Start option has not been selected.	Press and hold Start/Stop for three seconds if you want to cancel the Delayed Start option.

Problem	Possible causes	Action
The dishes are not clean.	The spray arms do not rotate.	Check that the dishes are not blocking the spray arms.
	Spray arm holes or bearings blocked.	Clean the spray arms and the middle basket's spray pipe. See the chapter <i>Care and maintenance instructions</i> .
	Unsuitable dishwashing program.	Select a program with Intensive mode (Heat Boost). The program will use a higher temperature to dissolve grease on very dirty dishes.
	Incorrect detergent dosage.	Dose according to water hardness. Far too much or far too little detergent can result in poor dishwashing results.
	Detergent is too old. Detergent is a perishable product.	Avoid large packages.
	Dishes loaded incorrectly.	Do not cover dishes with large bowls or lids. Avoid placing very tall glasses in the corners of the baskets.
	Glasses and cups have toppled over during the program.	Load the dishes securely.
	The filters are not fitted correctly.	Check that the filter handle is locked in the stop position.
	Drain pump stop missing.	Check that the colored stop on the right in the bottom drain is in place. See the chapter <i>Care and maintenance instructions</i> .
Spots on stainless steel or silver.	Some types of food, such as mustard, mayonnaise, lemon, vinegar, salt, and dressings, can cause spots on stainless steel if left for too long.	Rinse off these types of food if not starting the dishwasher immediately. Use the Rinse and hold program.
	All stainless steel can cause spots on silver if they come into contact during dishwashing. Aluminum can also cause spots on dishes.	In order to avoid marks and tarnishing, separate dishes made from different metals, such as silver, stainless steel, and aluminum.

Troubleshooting

Problem	Possible causes	Action
Spots or films on the dishes.	Incorrect rinse aid dosage setting.	See the chapter <i>Settings</i> .
	Too high temperature and/or too much detergent can cause etching on crystal. Unfortunately, this cannot be repaired, only prevented.	Wash crystal at a low temperature and with a conservative amount of detergent. Contact the detergent manufacturer.
The dishes have a sticky white/blue film.	Rinse aid dosage setting too high.	Reduce the dosage. See the chapter <i>Settings</i> . If you have very soft water, you may want to dilute the rinse aid 50:50 with water.
Spots left after washing.	Lipstick and tea can be difficult to wash off.	Use a detergent with a bleaching agent.
Detergent residue in the detergent compartment after dishwashing.	The detergent compartment was damp when adding detergent.	The detergent compartment must be dry when adding detergent.
	The detergent compartment has been blocked.	Check that the dishes are not preventing the detergent compartment from opening.
Rattling sound when dishwashing.	The dishes are not correctly placed or the spray arms are not rotating.	Check that the dishes are placed securely. Spin the spray arms to make sure they can rotate.
"Program paused" is shown on the display.	The dishwasher door has been opened while a program is in progress.	If you want the dishwashing program to continue, press Start/Stop and close the door within four seconds. If you want to cancel the dishwashing program, press and hold Start/Stop for three seconds.

Problem	Possible causes	Action
Water remains in the dishwasher above the filters.	The filters are clogged.	Clean the coarse and fine filters.
	The filters are not fitted correctly.	Check that the filter handle is locked in the stop position.
	Debris in the drain pump.	Clean the drain pump. See the chapter <i>Care and maintenance instructions</i> .
	Drain pump stop missing.	Check that the colored stop on the right in the bottom drain is in place. See the chapter <i>Care and maintenance instructions</i> .
	Kink in drain hose.	Check that the hose is free from kinks and sharp bends.
	Blocked drain hose.	Loosen the drain hose from where it terminates. Check that no debris has clogged the hose. Is the cone-shaped part of the drain boot cut to the maximum size of the fitting where it attaches?
Bad odor in dishwasher.	Dirt around the seals and in corners.	Clean with dish brush and low foaming cleaner.
	Low temperature programs have been selected for a prolonged period.	Run a program with a high temperature once or twice a month. Or run a self-cleaning program. See Self-cleaning in the chapter <i>Using the dishwasher</i> .
	The dishwasher is connected to a garbage disposer.	Cleaning the garbage disposer connected to the dishwasher can eliminate odors. Follow the disposer manufacturer's cleaning instructions.
Grease deposits in the dishwasher.	Low temperature programs have been selected for a prolonged period.	Select a program with Intensive mode (Heat Boost). The program will use a higher temperature to dissolve grease on very dirty dishes. Or run a self-cleaning program once or twice a month. See Self-cleaning in the chapter <i>Using the dishwasher</i> .

Troubleshooting

Problem	Possible causes	Action
The dishes are not dry enough.	Depending on the load, the program's drying cycle may be insufficient.	Activate the Extra Dry option.
	The dishwasher is not fully loaded.	Fully load the dishwasher.
	Rinse aid needs topping up or dosage is set too low.	Top up with rinse aid or increase the rinse aid dosage level. See the chapter <i>Settings</i> .
		Open the door a little once the program has finished.

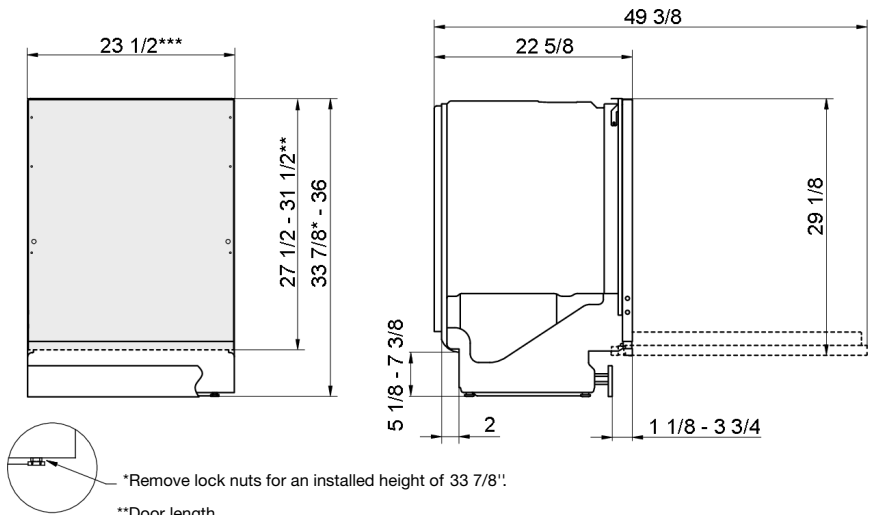

Nominal dimensions. Actual measurements may vary.

It is important that you read through and follow the instructions and directions below. Conduct installation and connection in accordance with the separate installation instructions.

Important safety instructions

- Connections to electricity, water, and drainage must be performed by a qualified professional.
- Always follow applicable regulations for water, drainage, and electricity.
- Take care during installation! Wear protective gloves! There must always be two people!
- Place a drip tray on the floor beneath the dishwasher to prevent damage from any water leaks.
- Before screwing the dishwasher into place, test the dishwasher by running the Rinse and hold program. Check that the dishwasher fills with water and drains. Also check that none of the connections leak.

⚠ WARNING!

Turn off the water supply when installing the dishwasher!

The plug must be disconnected or power to the outlet turned off while installing the dishwasher!

Setup

- The recess and connection dimensions are included in the separate installation instructions. Check that all dimensions are correct before starting the installation. Note that the height of the integrated door panel can be adjusted to match other fittings.

Installation instructions

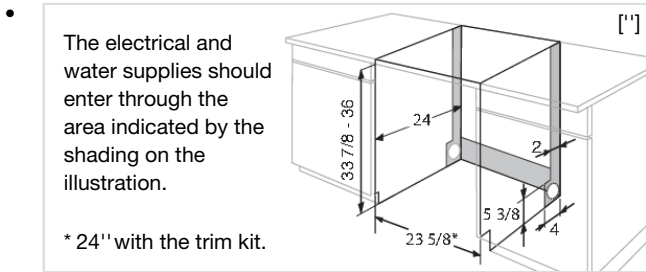

- Make sure the area on which the dishwasher is to be installed is firm. Adjust the adjustable feet so that the dishwasher is level. Tighten the lock nuts.
- If the dishwasher is built-in, the surrounding furnishings must be resistant to any condensation from the dishwasher.
- Fit the protective film (packed in the document bag) to the underside of the countertop. The protective film is to protect the countertop from moisture.
- Note that the door springs may need adjusting after a cover door has been fitted. Adjust the left and right door springs equally until the door is evenly balanced.

NOTE!

Framed cabinets require additional finished filler material behind the face frame for a proper installation. A minimum 3 1/2" (89 mm) finished return is required on all sides of the opening.

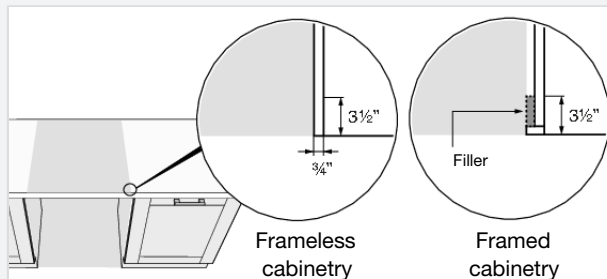

Drain connection

See the separate installation instructions for necessary information.

This dishwasher is suitable for installing in a raised recess (to attain an ergonomic working height). This means that the dishwasher can be placed so that the drain hose runs to a lower level than the bottom of the dishwasher, such as by routing it directly to a floor drain. The dishwasher is fitted with an integrated anti-siphon device to prevent the machine from being emptied of water during the wash cycle.

The drain hose can also be connected to a connection nipple on the sink unit's water trap. The connection nipple must have an internal diameter of at least 1/2".

The drain hose may be extended by a maximum of 87" (2.2 m) (the total length of the drain hose must not exceed 177" (4.5 m)). Any joins and connecting pipes must have an internal diameter of at least 1/2". However, the drain hose should ideally be replaced with a new hose without joins.

No part of the drain hose may be more than 37 3/8" above the bottom of the dishwasher.

Attach the drain hose with a hose clamp. Ensure that the drain hose has no kinks.

Connection to water supply

Use only the inlet hose supplied with the dishwasher. Do not re-use old or other spare hoses.

The supply pipe must be fitted with a water supply valve. The water supply valve must be easily accessible, so that the water can be shut off if the dishwasher has to be moved.

Once the installation is complete, turn on the water supply valve and allow the pressure to settle for a while. Check that all connections are watertight.

Water supply

The machine can be connected to either a cold or a hot (max. 160 °F (70 °C)) water supply. The water pressure should be 4.2-140 psi (0.03-1.0 MPa).

Connection to cold water supply

Connect the dishwasher to the cold water supply if the building is heated using oil, electricity, or gas.

Connection to hot water supply

Connect the dishwasher to the hot water supply (max. 160 °F (70 °C)) if the building is heated using an energy-efficient means such as district heating, solar power, or geothermal power. Choosing a hot water connection cuts dishwashing times and reduces the dishwasher's energy consumption.

NOTE!

Do not exceed the permitted water supply temperature. Certain materials used in some cookware cannot withstand strong heat. See *Fragile dishes* in the chapter *Loading the dishwasher*.

Electrical connection

Information about the electrical connection can be found on the serial number plate. This specification must match the electricity supply.

The power outlet for the appliance shall be installed in a cabinet or on a wall adjacent to the under-counter space in which the appliance is to be installed. Do not use an extension cord for this appliance.

The access hole for the electrical supply must be round and smooth and no bigger than 1 1/2" in diameter. If the partition is metal, it needs to be covered with an edge protector.

Use caution when the appliance is installed or removed to reduce the likelihood of damage to the power cord.

Grounding instructions

This appliance must be grounded. In the event of a malfunction or breakdown, grounding will reduce the risk of electric shock by providing a path of least resistance for electric current. This appliance is equipped with a power cord fitted with an equipment grounding conductor and a grounding plug. The plug must be plugged into an appropriate power outlet that is installed and grounded in accordance with all local codes and ordinances.

Installation instructions

WARNING!

Improper connection of the equipment grounding conductor can result in a risk of electric shock. Check with a qualified electrician or service representative if you are in doubt as to whether the appliance is properly grounded. Do not modify the plug provided with the appliance. If it does not fit the power outlet, have an appropriate power outlet installed by a qualified electrician.

Limited Warranty – Residential Appliances

This Limited Warranty covers parts and labor, except as set forth in this Limited Warranty. Service must be provided by an authorized ASKO service company. YOUR SOLE AND EXCLUSIVE REMEDY UNDER THIS LIMITED WARRANTY SHALL BE PRODUCT REPAIR AS PROVIDED HEREIN. This Limited Warranty is valid only when the ASKO Product is used in the country in which it was purchased. Proof of original purchase date is required to obtain service under this Limited Warranty.

Residential ASKO Products Used Exclusively for Household/Personal Purposes:

Two (2) Years limited Warranty – Any warranty service claims for residential ASKO Products must be filed with ASKO within two (2) years from date of purchase. Service will be provided during normal business hours.

Residential ASKO Products Not Used Exclusively for Household/Personal Purposes or used Commercially or used in Marine, Mobile or Aeronautical Applications:

One (1) Year limited Warranty – Any warranty service claims for ASKO Products not used exclusively for household and personal use, or used commercially or used in marine, mobile, or aeronautical applications must be filed with ASKO within one (1) year from date of purchase. Service will be provided during normal business hours.

Items excluded from warranty

This limited warranty does not cover:

1. Replacement parts or repair labor if the ASKO Product is used in a manner that is inconsistent with published user or operator instructions and/or installation instructions.
2. Service calls to correct the installation of the ASKO Product, to instruct you on how to use the ASKO Product, to replace or repair house fuses, or to correct house wiring or plumbing.
3. Consumable items and parts, such as filters.
4. Damage resulting from accident, alteration, misuse, abuse, negligence, fire, flood, natural disasters, improper use, improper installation, installation not in accordance with electrical or plumbing codes, or use of products not approved by ASKO, as well as any attempted repair by other than authorized ASKO service companies.
5. Cosmetic damage, including scratches, dents, chips or other damage to the finish of the ASKO Product, unless such damage results from defects in materials or workmanship and is reported to ASKO within 5 days from date of purchase.
6. Pickup and delivery. The ASKO Product is intended to be repaired in your home.
7. Repairs to parts or systems resulting from unauthorized modifications made to the ASKO Product.
8. Expenses for travel and transportation for product service if the ASKO Product is located in a remote area where service by an authorized ASKO service company is not available.
9. The removal and reinstallation of the ASKO Product if it is installed in an inaccessible location or is not installed in accordance with ASKO's published installation instructions.
10. Replacement parts or repair labor on ASKO Products with original model/serial numbers that have been removed, altered or cannot be easily determined.

Disclaimer

YOUR SOLE AND EXCLUSIVE REMEDY UNDER THIS LIMITED WARRANTY SHALL BE PRODUCT REPAIR AS PROVIDED HEREIN. EXPRESSLY DISCLAIMED ARE ALL OTHER EXPRESS AND IMPLIED WARRANTIES, INCLUDING ANY IMPLIED WARRANTIES OF MERCHANTABILITY AND FITNESS FOR A PARTICULAR PURPOSE. Some jurisdictions do not allow exclusion or limitations regarding warranty rights. This Limited Warranty gives you specific legal rights and you may have other rights

Service

that vary from jurisdiction to jurisdiction. Attempted repair by any person other than an authorized ASKO service company will void this Limited Warranty.

Limitation of liability

IN NO EVENT SHALL ASKO OR THE MANUFACTURER AND THEIR RESPECTIVE PARENTS, SUBSIDIARIES AND AFFILIATES BE LIABLE FOR CONSEQUENTIAL, INCIDENTAL, EXEMPLARY, PUNITIVE OR SPECIAL DAMAGES. IN NO EVENT SHALL ASKO OR THE MANUFACTURER AND THEIR RESPECTIVE PARENTS, SUBSIDIARIES AND AFFILIATES BE LIABLE FOR DAMAGES OTHER THAN ACTUAL DAMAGES AND IN NO EVENT FOR DAMAGES IN EXCESS OF THE PRICE PAID FOR THE ASKO PRODUCT AS TO WHICH A CLAIM IS MADE. Some jurisdictions do not allow the exclusion or limitation of incidental, consequential or other damages, so these limitations and exclusions may not apply to you. This Limited Warranty gives you specific legal rights. You also may have other rights that vary from jurisdiction to jurisdiction.

ASKO Customer Care

Read the chapter *Troubleshooting* before contacting the Customer Care Center. If you have encountered a problem that you cannot resolve, please contact your nearest dealer.

USA	us.asko.com, +1-800-898-1879
CANADA	ca.asko.com, +1-800-361-0799, service@distinctive-online.com
MEXICO	asko.com/mx, +52-800-400-4372, atencionalcliente@sub-zeromx.com

When making contact, provide the details on the serial number plate. Include the service number (1), the article number (2), and the serial number (3).

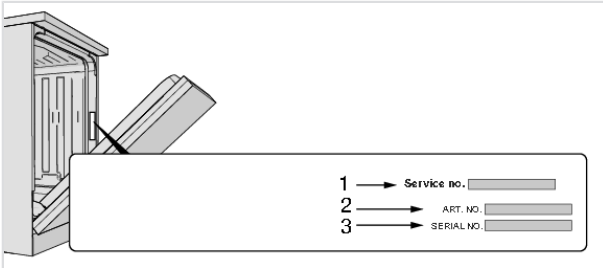

Service after expiration of limited warranty

For information about obtaining parts and labor after expiration of this Limited Warranty or arising outside the scope of this Limited Warranty, please contact ASKO Customer Care.

To verify the ASKO warranty – please visit our local web page.

Technical data

Height:	33 7/8 -36"
Width:	23 1/2" ¹⁾
Depth:	22 5/8"
Weight:	110 lb (50 kg) ²⁾
Water pressure:	4.2-140 psi (0.03-1.0 MPa)
Electrical connection:	See serial number plate
Rated power:	See serial number plate

¹⁾ 24" with the trim kit.

²⁾ Weight can vary due to different specifications.

ASKO

Inspired by Scandinavia

US.ASKO.COM • CA.ASKO.COM • ASKO.COM/MX



842709-a5

We reserve the right to make changes.