



DFI564XXL.U

Integrated dishwasher

General description

Turbo Combi Drying
Product line: Logic
Mode of installation: Panel Ready
Size: XXL
Number of baskets: 3
Number of place settings: 16 place settings
Top tray: Easy height adjustment; Handle; Removable
Upper basket type: Premium
Lower basket type: Premium
Removable cutlery basket for easy unloading



Construction

- Welded stainless steel container
- Exterior float - detects water leakage on the base
- Stand by water protection
- Anti-block drain pump
- 8 Steel™ Construction
- Hidden heater
- SCS+ - Super Cleaning System+™
- Number of spray arms: 3
- Number of spray zones: 9
- Turbo Combi Drying
- Automatic door opening
- Cutlery Power Zone - extra dishwashing power for the cutlery basket

Use and flexibility

- Number of place settings: 16 place settings
- Number of baskets: 3
- Top tray: Easy height adjustment; Handle; Removable
- Upper basket type: Premium
- Lower basket type: Premium
- Tight mesh base in the baskets
- Removable cutlery basket for easy unloading
- Required inlet water pressure: 0,03-1 MPa

Interaction & control

- Display Type: LCD display
- Ability to create own programs: Memory program
- Number of programs: 9
- Number of options: 6
- Status Light™
- Time remaining indicator: Yes
- Cycle end indication: Displayed with sound and light
- Adaptable power zones

Programs

- 9 programs: Normal wash; Quick wash; Intensive program; Time program; Rinse and hold; Self-cleaning; Light wash; Sanitize; Anti odour
- Delayed start: 1-24 hours
- Speed mode
- Night mode
- Heat boost mode
- Normal mode

Design & integration

- From front adjustable door spring
- From front adjustable rear foot
- Velcro strips
- Trim kit
- Multi fit outlet hose
- Simplified installation with integrated anti-siphon
- Depth (incl. wall spacing): 21 7/8" (555 mm)

- Height setting: 2 1/16" (53 mm)
- Possible adjustment of kick plate: 1 3/16 - 3 10/16" (30-94 mm)

Safety & Maintenance

- Aqua Safe™
- Kid Safe™ - lockable controls
- Rinse-aid indication: Notification in display

Technical data

- Hot or cold water connection - 9/16
- Max. temperature of inflow water: 140 F
- Noise level: 42 dB(A)
- Duration of normal wash cycle: 125 min
- Estimated annual energy consumption: 220 kWh
- Energy consumption/cycle: 1 kWh
- Estimated annual water consumption: 647 US Gal
- Water consumption/cycle: 3 US Gal
- Consumption in standby mode: 0.5 W
- Connection rating: 1300 W
- Number of phases: 1
- Current: 15 A
- Frequency: 60 Hz
- Required inlet water pressure: 0,03-1 MPa
- Net weight: 91 lbs

Dimensions

- Width: 23 15/16" (608 mm)
- Height: 33 13/16" (859 mm)
- Depth: 21 13/16" (554 mm)
- Maximum product height: 35 7/8" (912 mm)
- Cord length: 71 7/16" (1815 mm)
- Depth with door open: 48 7/16" (1231 mm)
- Length of inflow hose: 64 3/16" (1630 mm)
- Length of outflow hose: 90 9/16" (2300 mm)

Logistic information

- Packaging width: 25 3/16" (640 mm)
- Packaging height: 36 5/8" (930 mm)
- Packaging depth: 26 3/4" (680 mm)
- Total weight of packaged product: 99 lbs
- Code: 740104
- EAN code: 3838782627491
- Market: Domestic
- Range: Logic

Measurements: inches / millimetres

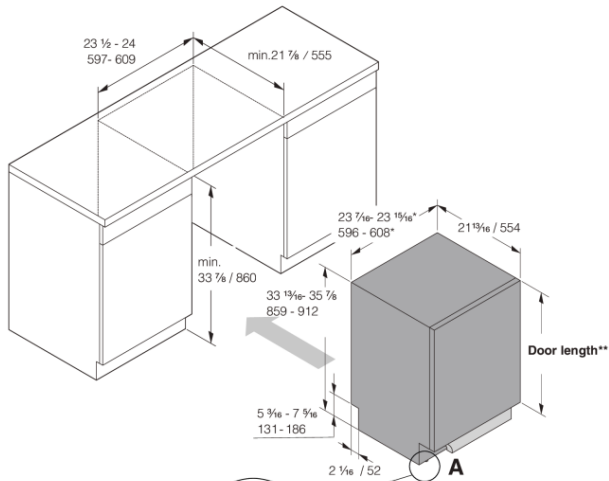

* Flexible side trims (width without side trims: 23 7/8 / 596)

** Door length:
27 5/8 - 31 1/2 / 700 - 800

DW60 Fully Integrated dishwasher XXL USA

