

Installation instructions

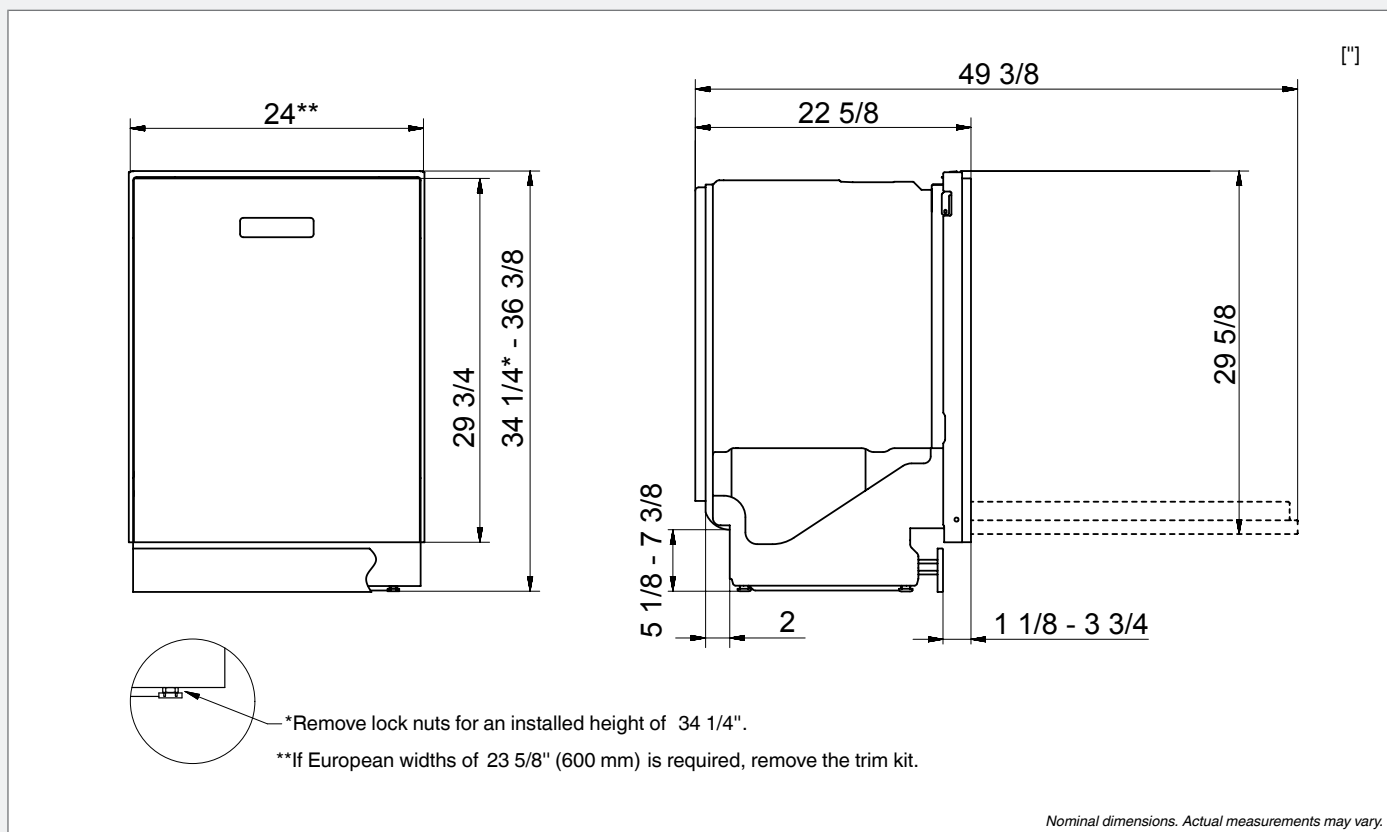

Important safety instructions

- Connections to electricity, water, and drainage must be performed by a qualified professional.
- Always follow applicable regulations for water, drainage, and electricity.
- Take care during installation! Wear protective gloves! There must always be two people!
- Place a drip tray on the floor beneath the dishwasher to prevent damage from any water leaks.
- Before screwing the dishwasher into place, test the dishwasher by running the Rinse and hold program. Check that the dishwasher fills with water and drains. Also check that none of the connections leak.

⚠ WARNING!

Turn off the water supply when installing the dishwasher!

The plug must be disconnected or power to the outlet turned off while installing the dishwasher!

Transport protection for the door

Do not forget to remove the transport protection for the door when unpacking the dishwasher.

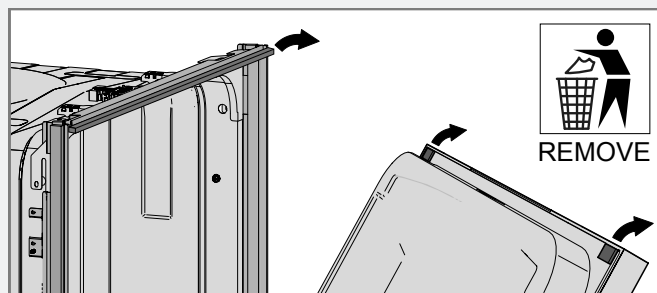

Trim kit

The dishwasher is equipped with a trim kit to fit the 24" cutout standard. If a European width of 23 5/8" (600 mm) is required, remove the trim kit.

Adjust the trim kit

The trim kit can be adjusted backward to level the dishwasher tub.

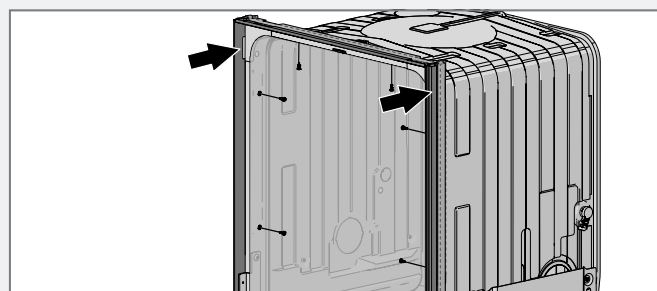

Placing the dishwasher

The dishwasher is intended to be built in under a countertop. The built-in measurements are shown in the illustration. Make sure that the cord and hose hole's edges are even and will not damage the drain and inlet hoses or the power cord.

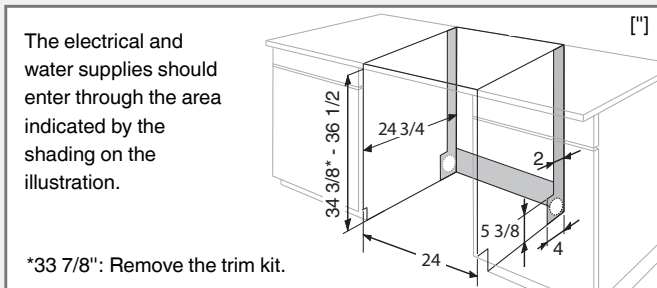

NOTE!

Framed cabinets require additional finished filler material behind the face frame for a proper installation. A minimum 3 1/2" (89 mm) finished return is required on all sides of the opening.

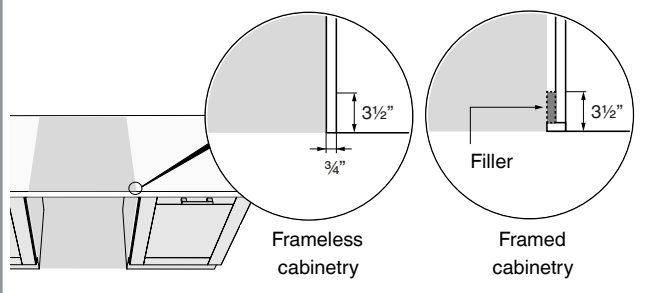

If the dishwasher is built-in, the surrounding furnishings must be resistant to any condensation from the dishwasher.

Fit the protective film

Fit the protective film (packed in the document bag) to the underside of the countertop. The protective film is to protect the countertop from moisture.

NOTE!

The surface to which the protective film is fitted must be clean and dry.

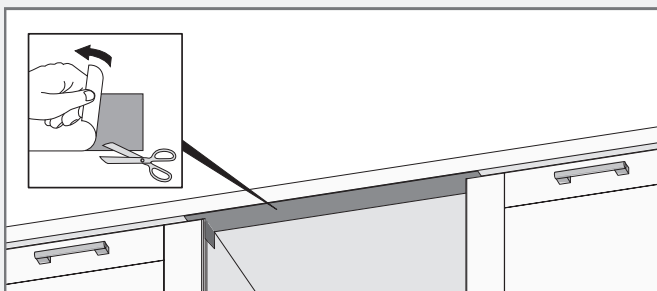

Adjust the height and slide the dishwasher into place

- 1 Start by measuring the height from the floor to the bottom edge of the countertop.
- 2 Measure the height from the floor to the top edge of the dishwasher.
- 3 Lean the dishwasher forward a little and roughly adjust the rear foot by turning the adjustment screw at the front clockwise to raise and counterclockwise to lower the dishwasher (see illustration below). Use a flat head screwdriver or a socket screwdriver.

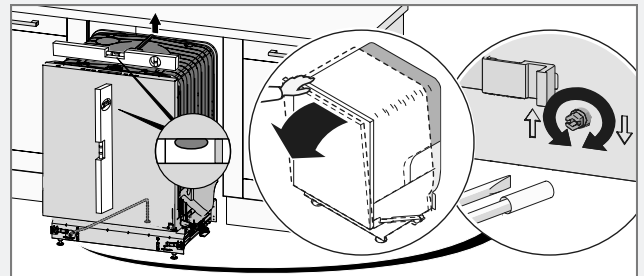

- 4 Adjust the front feet by turning them clockwise to raise and counterclockwise to lower the dishwasher.

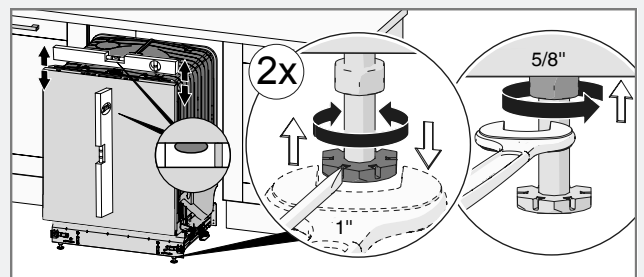

- 5 Verify there is an air gap of at least 1/8" between the underside of the countertop and the top edge of the dishwasher.
- 6 Slide the dishwasher into place.
 - Pull the drain and supply hoses through the opening as the dishwasher is slid into place.
 - Check that the hoses have no kinks or sharp bends, and check that there is nothing that can damage the hoses.

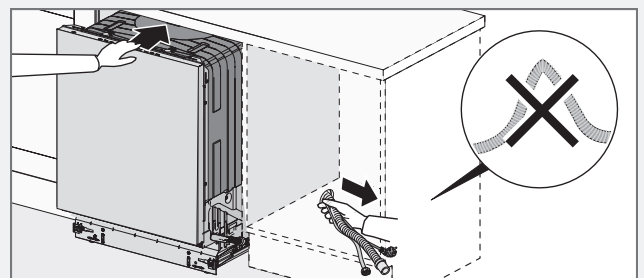

- 7 Make any final adjustments to the feet (the dishwasher may lean no more than 1/4") and tighten the lock nuts on the front feet.

Drain connection

This dishwasher is suitable for installing in a raised recess (to attain an ergonomic working height). This means that the dishwasher can be placed so that the drain hose runs to a lower level than the bottom of the dishwasher, such as by routing it directly to a floor drain. The dishwasher is fitted with an integrated anti-siphon device to prevent the machine from being emptied of water during the wash cycle.

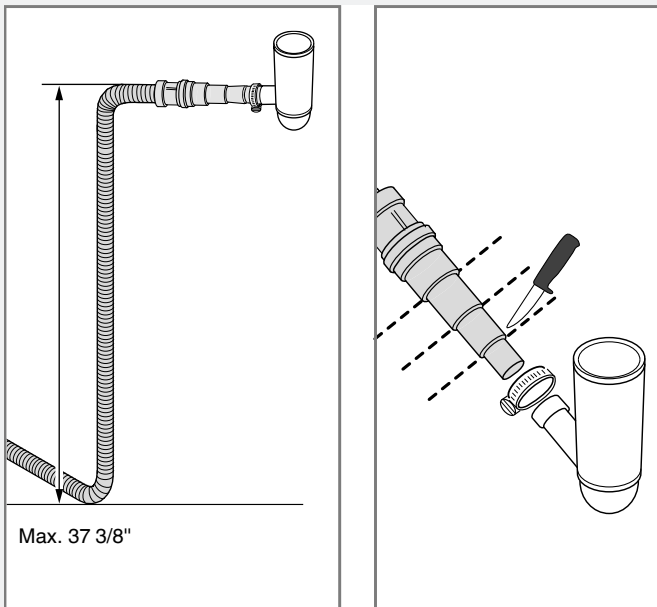
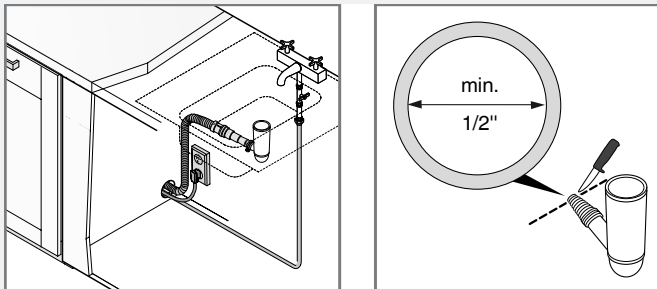

The drain hose can also be connected to a connection nipple on the sink unit's water trap. The connection nipple must have an internal diameter of at least 1/2".

The drain hose may be extended by a maximum of 87" (2.2 m) (the total length of the drain hose must not exceed 177" (4.5 m)). Any joins and connecting pipes must have an internal diameter of at least 1/2". However, the drain hose should ideally be replaced with a new hose without joins.

No part of the drain hose may be more than 37 3/8" above the bottom of the dishwasher.

Attach the drain hose with a hose clamp. Ensure that the drain hose has no kinks.

Connection to water supply

Use only the inlet hose supplied with the dishwasher. Do not re-use old or other spare hoses.

The supply pipe must be fitted with a water supply valve. The water supply valve must be easily accessible, so that the water can be shut off if the dishwasher has to be moved.

Once the installation is complete, turn on the water supply valve and allow the pressure to settle for a while. Check that all connections are watertight.

Water supply

The machine can be connected to either a cold or a hot (max. 160 °F (70 °C)) water supply. The water pressure should be 4.2-140 psi.

Connection to cold water supply

Connect the dishwasher to the cold water supply if the building is heated using oil, electricity, or gas.

Connection to hot water supply

Connect the dishwasher to the hot water supply (max. 160 °F (70 °C)) if the building is heated using an energy-efficient means such as district heating, solar power, or geothermal power. Choosing a hot water connection cuts dishwashing times and reduces the dishwasher's energy consumption.

NOTE!

Do not exceed the permitted water supply temperature. Certain materials used in some cookware cannot withstand strong heat. See Fragile dishes in the chapter Loading the dishwasher.

Electrical connection

Information about the electrical connection can be found on the serial number plate. This specification must match the electricity supply.

The power supply receptacle for the appliance must be installed in a cabinet or on a wall adjacent to the undercounter space in which the appliance is to be installed. Do not use an extension cord for this appliance.

The access hole for the electrical supply must be round and smooth and no bigger than 1 1/2" in diameter. If the partition is metal, it needs to be covered with an edge protector.

Use caution when the appliance is installed or removed to reduce the likelihood of damage to the power supply cord.

Grounding Instructions

This appliance must be grounded. In the event of a malfunction or breakdown, grounding will reduce the risk of electric shock by providing a path of least resistance for electric current. This appliance is equipped with a cord fitted with an equipment grounding conductor and a grounding plug. The plug must be plugged into an appropriate outlet that is installed and grounded in accordance with all local codes and ordinances.

! WARNING!

Improper connection of the equipment grounding conductor can result in a risk of electric shock. Check with a qualified electrician or service representative if you are in doubt as to whether the appliance is properly grounded. Do not modify the plug provided with the appliance. If it does not fit the outlet, have an appropriate outlet installed by a qualified electrician.

Screwing the dishwasher into place

(Applicable only to built-in dishwashers.)

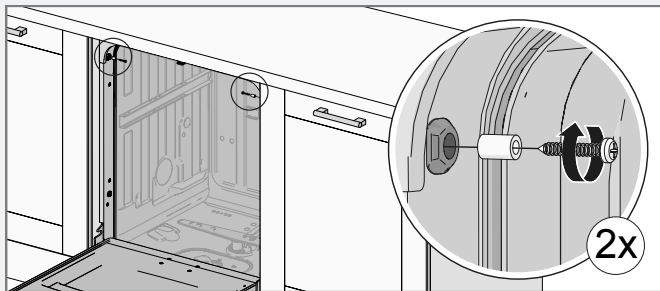

After fastening the machine, check that the front feet still touch the floor.

Screw the dishwasher into place with two extra screws

If there is an air gap of more than 1/8" between the underside of the countertop and the top edge of the dishwasher, the dishwasher ought to be screwed into place with two extra screws.

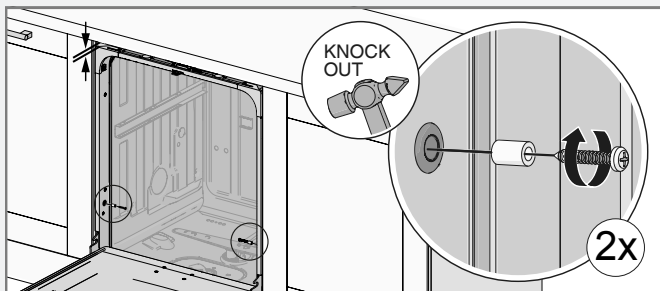

Dishwasher toe kick

The dishwasher is supplied with a toe kick.

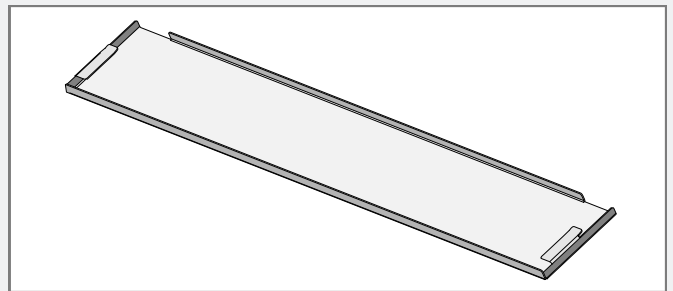

Fit the sound insulation

(only certain models)

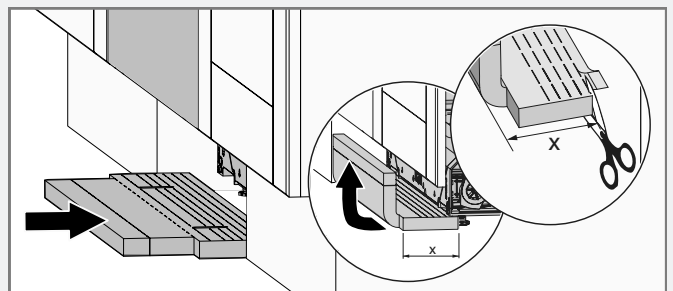
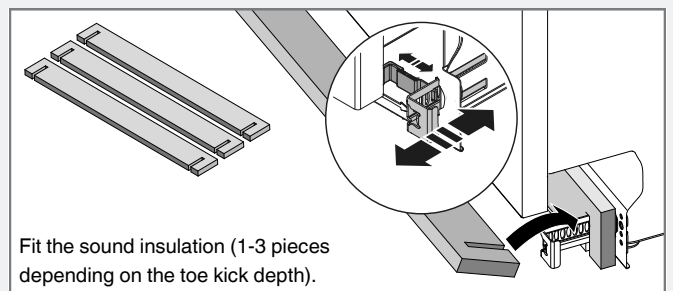

Fit the toe kick

