

IKB84431XB
30" Induction Cooktop

AEG

IKB84431XB

30" Induction Cooktop

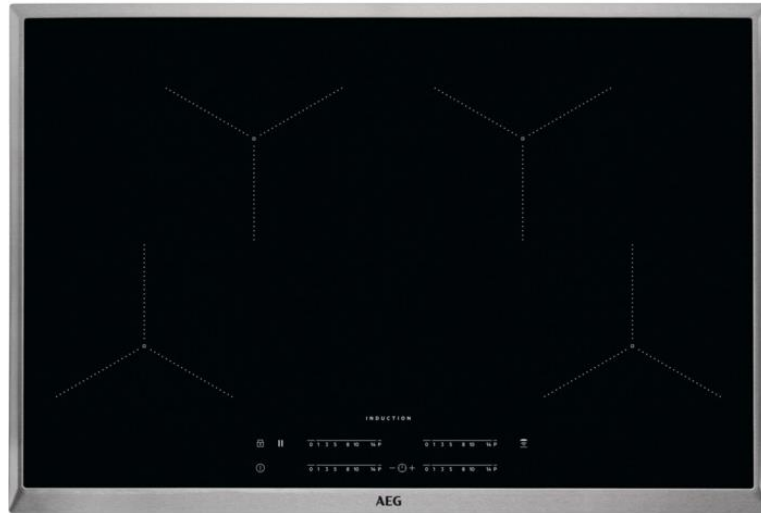

COOKTOP PERFORMANCE

- 4 Induction Zones
 - 4 x 21 CM :
2,300 Watts
Power Boost: 3,200 Watts

ELECTRICAL REQUIREMENTS

- 208 / 230 Volt, 60Hz, 40 AMP, 7350 W
- AEG Cooktops are supplied with a 5' long electrical cable and must be hard wired to the electrical supply.

COOKTOP FEATURES

- 30" (76cm) induction cooktop
- Stainless steel trim
- Electronic touch controls
- 4 induction zones with 14 power levels
- LED display indicating power level
- Power Boost
- Adjustable timer – max 99 mins.
- Stop+Go function
- Child safety lock
- 3 step Residual heat indicator
- Automatic heat up
- Auto switch off

IKB84431XB

SPECIFICATIONS

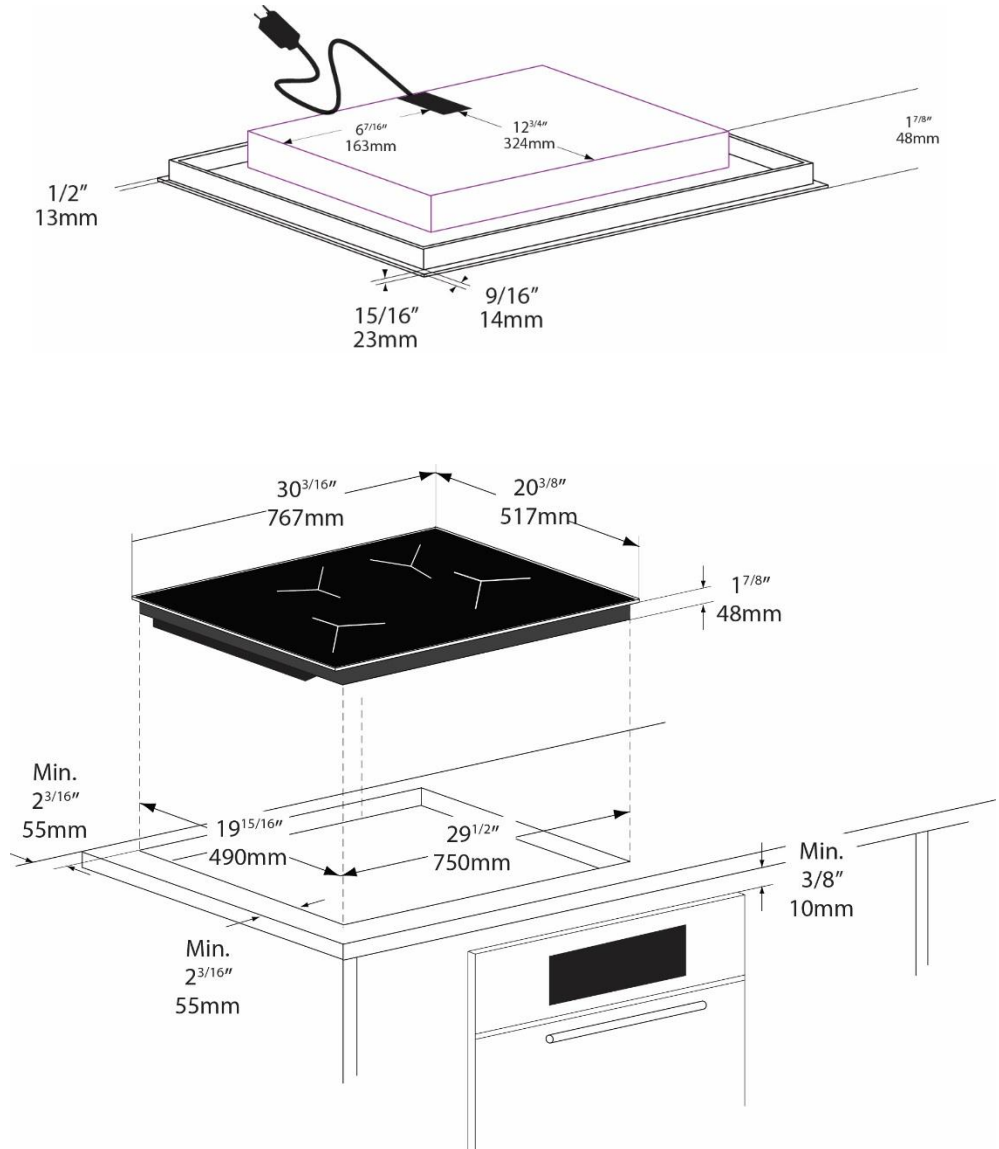

COOKTOP DIMENSIONS

- D: 20^{3/8}" x W: 30^{3/16}"
- D: 517mm x W: 767mm

CUT-OUT DIMENSIONS

- D: 19^{5/16}" x W: 29^{1/2}"
- D: 490mm x W: 750mm

IKB84431XB

SPECIFICATIONS

INSTALLING OVER BUILT-IN OVEN

- There must be a minimum of 20mm (13/16") of space left between the bottom of the cooktop and the oven to allow air to flow.
- There must be a minimum of 5mm (3/16") of space left between the counter top and the door panel of a built-in oven / drawer.
- If sufficient air flow is not provided, the life of the appliance will be shortened.

SIDE VIEW

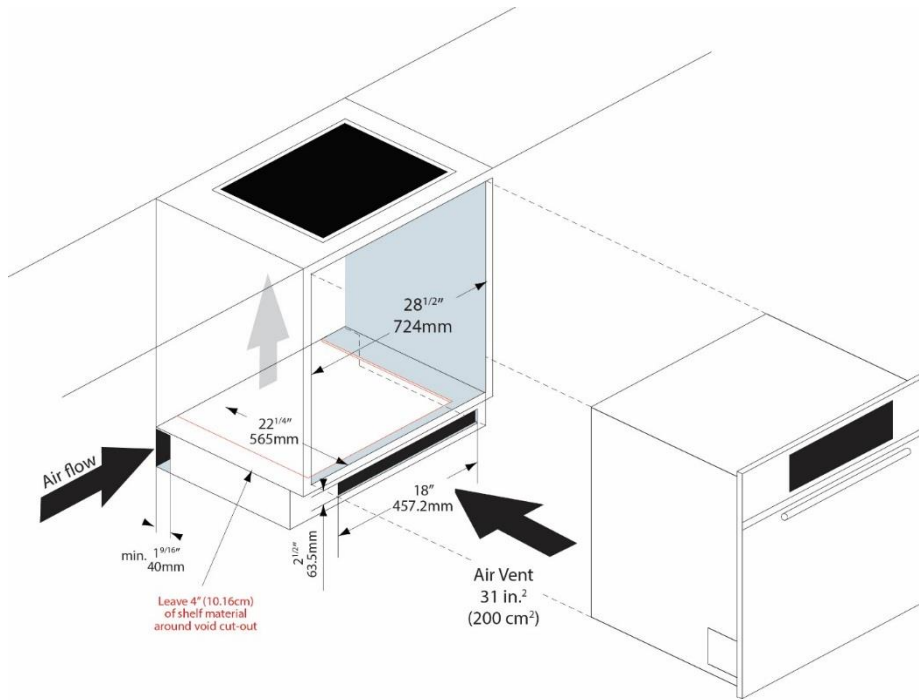
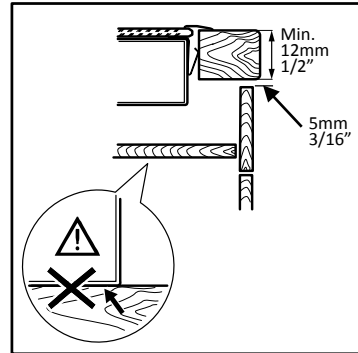

IKB84431XB

SPECIFICATIONS

RECOMMENDED CABINET MINIMUM CLEARANCE

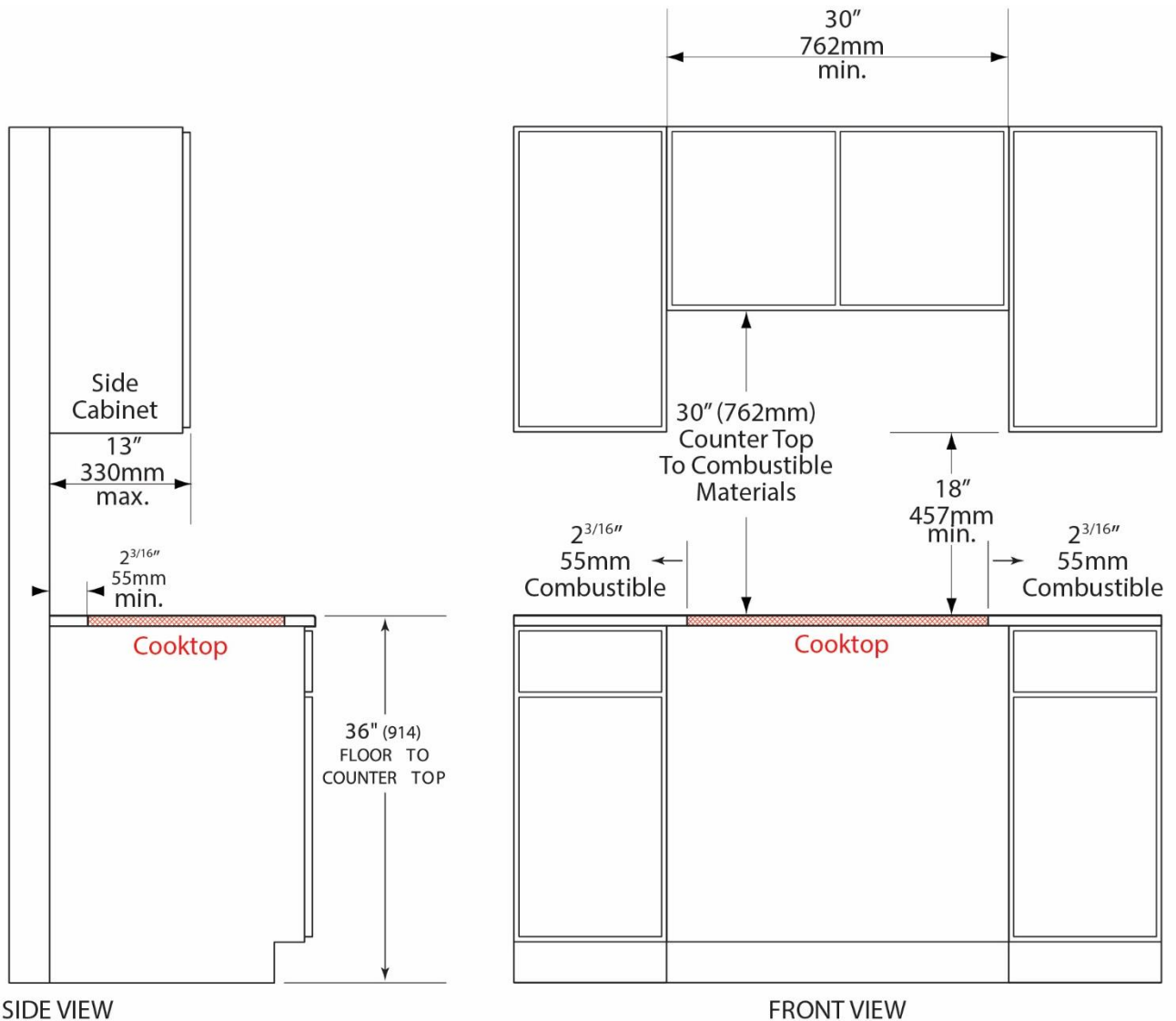

* Minimum clearance from cooktop cut-out to combustible materials up to 18" (457mm) above countertop

AEG

AEG Appliances are designed and manufactured to the highest standards. Each appliance is covered by a comprehensive 2-year parts and labour warranty.

Refer to product warranty policy for complete terms and conditions.

FOR PARTS AND SERVICE

Euro-Parts & Service

39822 Belgrave Road, Belgrave, ON. N0G 1E0

1 800 678 8352 (Canada) • 1 800 561 4614 (U.S.)

www.euro-parts.ca • parts@euro-parts.ca • service@euro-parts.ca

AEG appliances are imported and distributed in North America by Euro-Line Appliances Inc. For more information, please visit one of our showrooms or

www.euro-line-appliances.com www.elawest.com

EURO-LINE APPLIANCES INC.

871 Cranberry Court
Oakville, ON L6L 6J7 Canada
905 829 3980
1 800 421 6332

marketing@euro-line-appliances.com

EURO-LINE APPLIANCES WEST INC.

101-1014 Homer Street
Vancouver, BC V6B 2W9 Canada
604 235 3980
1 855 ELA WEST (352 9378)

info@elawest.com

