

User's Manual

HK854220XB 30" Induction Cooktop -
User's Manual



 **AEG**

perfekt in form und funktion

HK854220XB

User manual

Ceramic glass induction
hob

Thank you for choosing one of our high-quality products.

To ensure optimal and regular performance of your appliance please read this instruction manual carefully. It will enable you to navigate all processes perfectly and most efficiently. To refer to this manual any time you need to, we recommend you to keep it in a safe place. And please pass it to any future owner of the appliance.

We wish you much joy with your new appliance.

Contents

<u>Safety information</u>	2	Starting the STOP+GO	10
<u>Installation instructions</u>	4	Locking / unlocking the control panel	10
<u>Product description</u>	6	The child safety device	10
<u>Operating instructions</u>	7	OffSound Control (Switching off and on the sounds)	11
On and Off	7	<u>Helpful hints and tips</u>	11
Automatic Switch Off	8	<u>Care and cleaning</u>	12
The heat setting	8	<u>What to do if...</u>	13
Automatic Heat Up	8	<u>Environment concerns</u>	14
Switching on and off the power function	9	Packaging material	14
Using the Timer	9		

Subject to change without notice



Safety information



For your safety and correct operation of the appliance, read this manual carefully before installation and use. Always keep these instructions with the appliance even if you move or sell it. Users must fully know the operation and safety features of the appliance.

General safety



WARNING!

Persons (including children) with reduced physical sensory, mental capabilities or lack of experience and knowledge must not use the appliance. They must have supervision or instruction for the operation of the appliance by a person responsible for their safety.

Child safety

- Only adults can use this appliance. Children must get supervision to make sure that they do not play with the appliance.
- Keep all packaging away from children. There is a risk of suffocation.
- Keep children away from the appliance when it is on.

**WARNING!**

Start the child safety device to prevent small children and pets from an accidental activation of the appliance.

Safety during operation

- Remove all packaging, stickers and layers from the appliance before the first use.
- Set the cooking zones to "off" after each use.
- Risk of burns! Do not put metallic objects, for example cutlery or saucepan lids, on the cooking surface, as they can become hot.
- Users with an implanted pacemaker must keep their upper body minimum 30 cm from induction cooking zones that are switched on.

**WARNING!**

Fire danger! Overheated fats and oils can catch fire very quickly.

Correct operation

- Always monitor the appliance during operation.
- Only use the appliance for domestic cooking tasks!
- Do not use the appliance as a work or a storage surface.
- Do not put or keep very flammable liquids and materials, or fusible objects (made of plastic or aluminium) on or near the appliance.
- Be careful when you connect the appliance to the near sockets. Do not let electricity bonds touch the appliance or hot cookware. Do not let electricity bonds tangle.

How to prevent a damage to the appliance

- If the objects or cookware fall on the glass ceramic, the surface can be damaged.
- Cookware made of cast iron, cast aluminium or with damaged bottoms can scratch the glass ceramic if you move them on the surface.
- Do not let cookware boil dry to prevent the damage to cookware and glass ceramics.
- Do not use the cooking zones with empty cookware or without cookware.
- Do not cover the parts of the appliance with aluminium foil.
- Do not cover the ventilation space of 5 mm between the worktop and front of the unit below it.

**WARNING!**

If there is a crack on the surface, disconnect power supply to prevent the electric shock.

Installation instructions



Before the installation, note down this data from the rating plate:

- Model description (Modell).....
- Product number (Prod. Nr.)
- Serial number (Ser. Nr.)

You find the rating plate of the appliance on its lower casing.

Modell HK854220X-B	Prod.Nr. 949 593 273 00
Typ 58 GBD C2 AU	220-240 V 50-60-Hz Induction 7,4 kW
Made in Germany	Ser.Nr. 7,4 kW
AEG-ELECTROLUX	CE

Safety instructions



WARNING!

You must read these!

Make sure that the appliance is not damaged because of transportation. Do not connect a damaged appliance. If it is necessary, speak to the supplier.

Only an authorised service technician can install, connect or repair this appliance. Use only original spare parts.

Only use built-in appliances after you assemble the appliance into correct built-in units and work surfaces that align to the standards.

Do not change the specifications or modify this product. Risk of injury and damage to the appliance.

Fully obey the laws, ordinances, directives and standards in force in the country where you use the appliance (safety regulations, recycling regulations, electrical safety rules etc.)!

Keep the minimum distances to other appliances and units!

Install anti-shock protection, for example install the drawers only with a protective floor directly below the appliance!

Protect the cut surfaces of the worktop against moisture with a correct sealant!

Seal the appliance to the work top with no space left with a correct sealant!

Protect the bottom of the appliance from steam and moisture, e.g. from a dishwasher or oven!

Do not install the appliance adjacent to doors and below windows! If not, hot cookware can be hit off the hob when you open doors or windows.



WARNING!

Risk of injury from electrical current. Carefully obey the instructions for electrical connections.

- The electrical mains terminal is live.
- Make electrical mains terminal free of voltage.
- Install correctly to give anti-shock protection.
- Loose and incorrect plug and socket connections can make the terminal become too hot.
- A qualified electrician must install the clamping connections correctly.
- Use a strain relief clamp on cable.
- Use the correct mains cable of type H05BB-F Tmax 90°C (or higher) for a single-phase or two-phase connection.

- Replace the damaged mains cable with a special cable (type H05BB-F Tmax 90°C; or higher). Speak your local Service Force Centre.

The appliance must have the electrical installation which lets you disconnect the appliance from the mains at all poles with a contact opening width of minimum 3 mm.

You must have correct isolation devices: line protecting cut-outs, fuses (screw type fuses removed from the holder), earth leakage trips and contactors.

Assembly

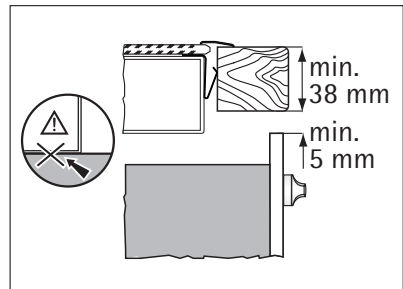
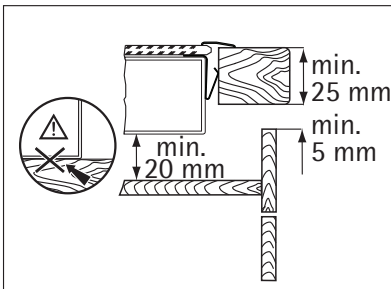
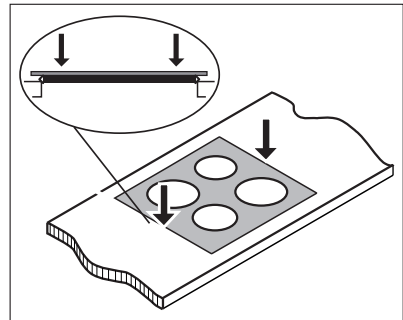
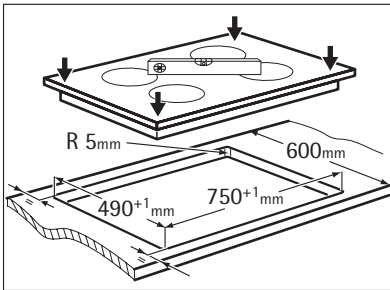
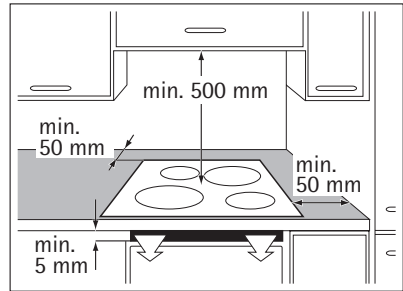
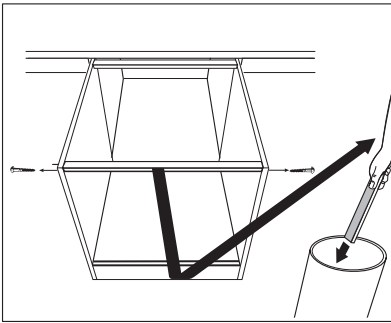

i If you use a protection box (additional accessory), the front ventilation space of 5 mm and protective floor directly below the appliance are not necessary.

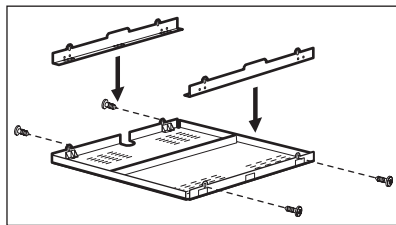

Product description

Cooking surface layout

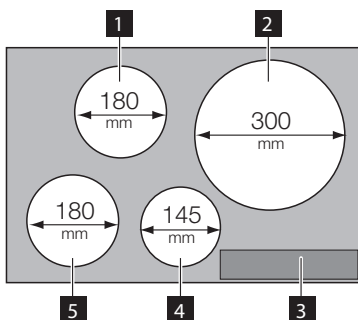

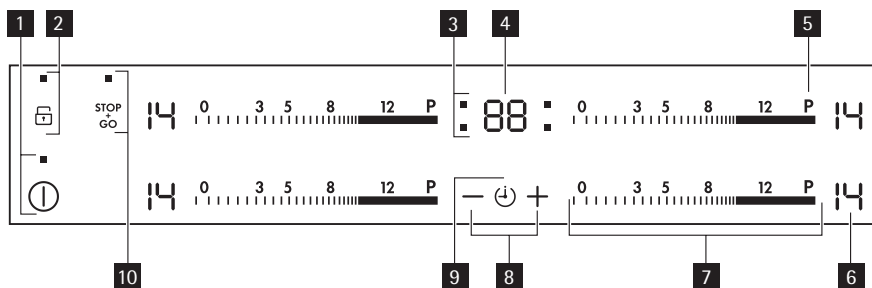

- 1** Induction cooking zone 1800W, with the Power function 2800W
- 2** Induction cooking zone 2400W, with the Power function 3700W
- 3** Control panel
- 4** Induction cooking zone 1400 W, with Power function 2500W
- 5** Induction cooking zone 1800W, with the Power function 2800W

Control panel layout















Use the sensor fields to operate the appliance.

	sensor field	function
1	ⓘ	starts and stops the hob
2	🔒	starts and stops the key lock or child lock
3	cooking zones' indicators of timer	shows for which zone you set the time
4	the timer display	shows the time in minutes
5	P	starts the Power function

	sensor field	function
6	a heat setting display	shows the heat setting
7	a control bar	to set the heat setting
8	+ / -	increases or decreases the time
9		selects the cooking zone
10	 with an indicator	starts and stops STOP+GO

Heat setting displays



Displays show which functions operate

Display	Description
	The cooking zone is off
 - 	The cooking zone operates
	Keep Warm
	The automatic heat-up function is on
	Power function is on
 + digit	There is a malfunction
 /  / 	OptiHeat Control (3 step Residual heat indicator): still cooking / keep warm / residual heat
	Lock/Child safety function is on
	Cookware unsuitable or too small or no cookware on the cooking zone
	The automatic switch off is on

OptiHeat Control (3 step Residual heat indicator)



WARNING!

 \  \  Risk of burns from residual heat!

OptiHeat Control indicates the level of the residual heat. The induction cooking zones make the heat necessary for cooking directly in the bottom of the cookware. The glass ceramic is slightly heated by the residual heat of the cookware.

Operating instructions



Use the induction cooking zones with suitable cookware.

On and Off

Touch  for 1 second to start or stop the appliance.

Automatic Switch Off

The function stops the hob automatically if:

- all cooking zones are off.
- you do not set the heat setting after you start the hob.
- you cover a sensor field with an object (a pan, a cloth, etc.) for longer than 10 seconds. The sound operates until you remove the object.
- the hob gets too hot (e.g. when a saucepan boils dry). Before you use the hob again, the cooking zone must be cool.
- you use incorrect cookware. **F** comes on and after 2 minutes the cooking zone stops automatically.
- you do not stop a cooking zone or change the heat setting. After some time **[-]** comes on and the hob stops. See the table.

Automatic Switch Off times

Heat setting	0 - 3	4 - 6	7 - 8	9 - 14
Stops after	6 hours	5 hours	4 hours	1.5 hours

The heat setting

Touch the control bar at the necessary heat setting. Change to the left or the right, if it is necessary. Do not release before you have a correct heat setting. The display shows the heat setting.

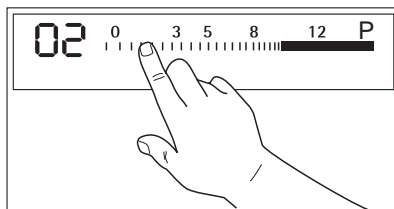

Automatic Heat Up

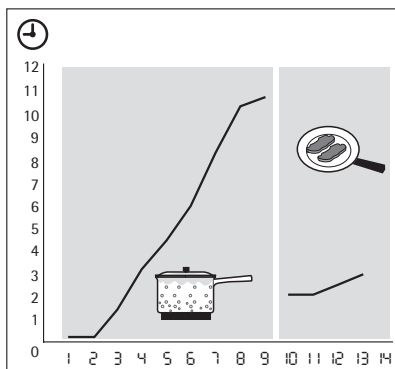

You can get a necessary heat setting in a shorter time if you activate the Automatic Heat Up function. This function sets the highest heat setting for some time (see the graphic), and then decreases to the necessary heat setting.

To start the Automatic Heat Up function for a cooking zone:

1. Touch **P** (**P** comes on in the display).

2. Immediately touch the necessary heat setting. After 3 seconds **P** comes on in the display.

To stop the function change the heat setting.

Switching on and off the power function

The power function gives more power to an induction cooking zone for no longer than 10 minutes. After that time, the induction cooking zone automatically sets back to **14**. To start it, touch **P** and **P** comes on. To stop it, set a heat setting between **1** and **14**.

Power management

The power management divides the power between two cooking zones in a pair (see the figure). The power function increases the power to the maximum level for one cooking zone in the pair and automatically decreases in the second cooking zone to a lower power level. The display for the reduced zone alternates.

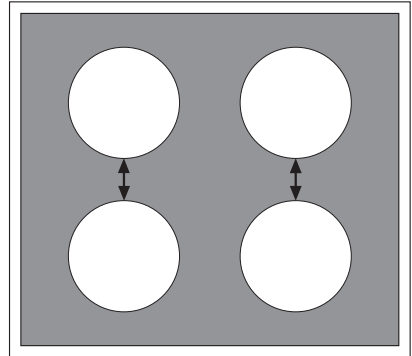

Using the Timer

Count Down Timer

Use the Count Down Timer to set how long the cooking zone operates for one cooking session.

Set the Count Down Timer after the selection of the cooking zone.

You can set the heat setting before or after you set the timer.





- **Selection of the cooking zone:** touch **⌚** again and again until the indicator of a necessary cooking zone comes on.
- **Starting the Count Down Timer:** touch **+** of the timer to set the time (**00 - 99** minutes). When the indicator of the cooking zone flashes slower, the time counts down.
- **Checking the remaining time:** select the cooking zone with **⌚**. The indicator of the cooking zone flashes faster. Display shows the remaining time.
- **Changing the Count Down Timer:** select the cooking zone with **⌚** touch **+** or **-**.
- **Stopping the timer:** select the cooking zone with **⌚**. Touch **-**. The remaining time counts backwards to **00**. The indicator of the cooking zone goes out. To switch off You can also touch **+** and **-** at the same time.

When the time elapses, the sound operates and **00** flashes. The cooking zone switches off.



- **Stopping the sound:** touch **⌚**

CountUp Timer (Count up timer)

Use the CountUp Timer to monitor how long the cooking zone operates.







- **Selection of the cooking zone (if more than 1 cooking zone operate):** touch  again and again until the indicator of a necessary cooking zone comes on.
- **Starting the CountUp Timer:** touch $-$ of the timer  comes on. When the indicator of the cooking zone flashes slower, the time counts up, display switches between  and time elapsed (minutes)
- **Checking the elapsed time:** select the cooking zone with . The indicator of the cooking zone flashes faster. Display shows the elapsed time.
- **Stopping the CountUp Timer:** select the cooking zone with  and touch $+$ or $-$ to switch off the timer. The indicator of the cooking zone goes out.

Minute Minder

You can use the timer as a **Minute Minder** while cooking zones do not operate. Touch . Touch $+$ or $-$ of the timer to select the time. When the time elapses, the sound operates and  flashes.



Starting the STOP+GO

The  function sets all cooking zones that operate to a keep warm setting.

- **Touch  to start** this function. The symbol  comes on.
 - **Touch  to stop** this function. The heat setting that you set before comes on.
-  does not stop the timer function.
-  fully locks the control panel but not the sensor field .

Locking / unlocking the control panel

You can lock the control panel, but not . You can stop the appliance.

Touch the symbol . The symbol  comes on for 4 seconds.

The Timer still operates.





Touch the symbol  to switch off this function. The heat setting that you set before comes on.

When you switch off the appliance, you also switch off this function.





The child safety device

This function prevents an accidental operation of the hob.





Starting the child safety device

- Start the hob with . **Do not set the heat settings.**
- Touch  for 4 seconds. The symbol  comes on.
- Stop the hob with .

Switching off the child safety device

- Start the hob with . **Do not set the heat settings.** Touch  for 4 seconds. The symbol  comes on.
- Stop the hob with .





Overriding the child safety device for one cooking session

- Start the hob with . The symbol  comes on.
- Touch  for 4 seconds. **Set the heat setting in less than 10 seconds.** You can operate the hob.
- When you stop the hob with , the child safety device operates again.

OffSound Control (Switching off and on the sounds)

Switching off the sounds





Switch off the appliance.

Touch  for 3 seconds. The displays come on and go out. Touch  for 3 seconds.  comes on, the appliance is in standard mode. Touch  ,  comes on, the sound is off.

When the sound is off, you hear only when you touch  , Minute Minder or Count Down Timer come down or when you cover the control panel.

Switching on the sounds

Switch off the appliance.

Touch  for 3 seconds. The displays come on and go out. Touch  for 3 seconds.  comes on, because the sound is off. Touch  ,  comes on, the appliance is in standard mode.

The sound is on.

Helpful hints and tips

Cookware for induction cooking zones



In induction cooking a powerful electromagnetic field generates an almost instant heat inside the cookware.

Cookware material

- **correct:** cast iron, steel, enamelled steel, stainless steel, a multi-layer bottom (marked as correct by a manufacturer).
- **not correct:** aluminium, copper, brass, glass, ceramic, porcelain.

Cookware is correct for an induction hob if ...

- ... some water boils very quickly on a zone set to the highest heat setting..
- ... a magnet pulls on to the bottom of the cookware.



The bottom of the cookware must be as thick and flat as possible.

Cookware dimensions : induction cooking zones adapt to the dimension of the bottom of the cookware automatically to some limit. But, the magnetic part of the bottom of the cookware must have a minimum diameter of approximately 3/4 of the cooking zones.

Energy saving



- If possible, always put the lids on the cookware.
- Put cookware on a cooking zone before you start it.

Öko Timer (Eco Timer)



To save the energy, the heater of the cooking zone switches itself off earlier than count down timer signal. The heating time reduction depends on cooking level and cooking time.

Examples of cooking applications

The data in the table is for guidance only.

Heat setting	Use to:	Time	Hints
 1	Keep cooked foods warm	as required	Cover
1-3	Hollandaise sauce, melt: butter, chocolate, gelatine	5-25 min	Mix occasionally
1-3	Solidify: fluffy omelettes, baked eggs	10-40 min	Cook with a lid on
3-5	Simmer rice and milkbased dishes, heating up ready-cooked meals	25-50 min	Add at least twice as much liquid as rice, stir milk dishes part way through
5-7	Steam vegetables, fish, meat	20-45 min	Add a few tablespoons of liquid
7-9	Steam potatoes	20-60 min	Use max. ¼ l water for 750 g of potatoes
7-9	Cook larger quantities of food, stews and soups	60-150 min	Up to 3 l liquid plus ingredients
9-12	Gentle fry: escalope, veal cordon bleu, cutlets, rissoles, sausages, liver, roux, eggs, pancakes, doughnuts	as required	Turn halfway through
12-13	Heavy fry, hash browns, loin steaks, steaks	5-15 min	Turn halfway through
14	Boil large quantities of water, cook pasta, sear meat (goulash, pot roast), deep fry chips		

The Power function is suitable for heating large quantities of water.

Information on acrylamides



According to the newest scientific knowledge, if you brown food (specially the one which contains starch), acrylamides can pose a health risk. Thus, we recommend that you cook at the lowest temperatures and do not brown food too much.

Operating noises

If you can hear

- cracking noise: cookware is made of different materials (Sandwich construction).
- whistling: you use one or more cooking zones with high power levels and the cookware is made of different materials (Sandwich construction).
- humming: you use high power levels.
- clicking: electric switching occurs.
- hissing, buzzing: the fan operates.

The noises are normal and do not refer to any defects.

Care and cleaning

Clean the appliance after each use.

Always use cookware with clean bottom.



WARNING!

Sharp objects and abrasive cleaning agents will damage the appliance. For your safety, do **not** clean the appliance with steam blasters or high-pressure cleaners.



Scratches or dark stains on the glass ceramic have no effect on how the appliance operates.

Removing the dirt:

1. – **Remove immediately:** melting plastic, plastic foil, and food containing sugar. Use a special glass ceramic scraper. Put the scraper on the glass ceramic surface at an acute angle and slide the blade on the surface.
 - **Stop the appliance and let it cool down** before you clean: limescale rings, water rings, fat stains, shiny metallic discolorations. Use a special cleaner for glass ceramic or stainless steel.
2. Clean the appliance with a damp cloth and some detergent.
3. At the end **rub the appliance dry with a clean cloth.**

What to do if...

Problem	Possible cause and remedy
You cannot start the appliance or operate it.	<ul style="list-style-type: none"> • You touched 2 or more sensor fields at the same time. Only touch one sensor field. • There is water or fat stains on the control panel. Clean the control panel • Start the appliance again and set the heat setting in 10 seconds. • The child safety device or key lock or Stop+Go operates. See the chapter Operating the appliance.
A sound operates when the appliance is off.	You covered one or more sensor fields. Uncover the sensor fields.
The residual heat indicator does not come on.	The cooking zone is not hot because it operated only for a short time. If the cooking zone is supposed to be hot, speak to the After Sales Service.
Heat setting alternates	The Power management is active. See the section Power management.
A sound operates and appliance starts and stops again. After 5 seconds one more sound operates.	You covered ①. Uncover the sensor field.
 comes on	<ul style="list-style-type: none"> • The automatic switch-off operates. Stop the appliance and start it again. • Overheating protection for the cooking zone operates. Switch off the cooking zone. Switch on the cooking zone again.

Problem	Possible cause and remedy
F comes on	<ul style="list-style-type: none"> No cookware on the cooking zone. Put cookware on the cooking zone. Not correct cookware. Use the correct cookware. The diameter of the bottom of the cookware is too small for the cooking zone. Move cookware to a smaller cooking zone.
E and number come on.	There is an error in the appliance. Disconnect the appliance from the electrical supply for some time. Disconnect the fuse from the electrical system of the house. Connect again. If E comes on again, speak to the after sales service.
E4 comes on	There is an error in the appliance, because a cookware boils dry or you use not correct cookware. Overheating protection for the cooking zone operates. The automatic switch-off operates. Switch off the appliance. Remove the hot cookware. After approximately 30 seconds switch on the cooking zone again. E4 should disappear, residual heat indicator can stay. Cool down the cookware and check it with the section Cookware for the induction cooking zone.
There is no signal when you touch panel keys	The signals are off. Switch on the signals.

If you tried the above solutions and cannot repair the problem, speak to your dealer or the Customer Care Department. Give the data from the rating plate, three-digit-letter code for the glass ceramic (it is in the corner of the cooking surface) and an error message that comes on.

If you operated the appliance incorrectly, the servicing by a customer service technician or dealer will not be free of charge, even during the warranty period. The instructions about the customer service and conditions of guarantee are in the guarantee booklet.

Environment concerns

The symbol  on the product or on its packaging indicates that this product may not be treated as household waste. Instead it should be taken to the appropriate collection point for the recycling of electrical and electronic equipment. By ensuring this product is disposed of correctly, you will help prevent potential negative consequences for the environment and human health, which could otherwise be caused by inappropriate waste handling of this product. For more detailed information about recycling of this product, please contact your local council, your household waste disposal service or the shop where you purchased the product.

Packaging material



The packaging materials are friendly to the environment and can be recycled. The plastic components are identified by marking: >PE<, >PS<, etc. Discard the packaging materials as household waste at the waste disposal facilities in your municipality.

Q - Warranty

AEG products are designed and built to the highest standards.
We expect your appliances to provide many years of trouble free enjoyment.
In the event of an appliance requiring attention, each appliance is covered by a 2 year warranty from the date of purchase.

Refer to warranty policy for complete terms and conditions.

Coverage is for costs of parts and labor for appliances in capital cities & metropolitan areas. We reserve the right to charge directly for handling expenses outside the metropolitan region.

AEG products are supported by a national service support system.
Call our customer service department for attention.

Please retain your invoice **AEG to quote should you require service assistance. This will identify your product for our priority service back-up. Please attach your invoice to this manual for easy future reference.**

AEG Canada
871 Cranberry Court
Oakville, Ontario L6L 6J7
Canada

Tel 905-829.3980
Fax 905-829.3985
email marketing@euro-line-appliances.com

For Service & Spares:
EURO-PARTS
1.800.678.8352

Important: Please record details of your purchase below and mail or fax to AEG

-----cut along line-----



Name: _____ TEL No _____
Address: _____
City : _____ State: _____ Zip Code: _____
Where purchased: _____ Purchase date: _____
Items purchased: _____
Serial No. (s): _____

AEG appliances are imported and distributed in North America by Euro-Line Appliances Inc.
For more information visit
www.euro-line-appliances.com / www.elawest.com

EURO-LINE APPLIANCES INC.

871 Cranberry Court
Oakville, ON L6L 6J7
Canada
Toll Free: 1.800.421.6332
Showroom: 905.829.3980
marketing@euro-line-appliances.com

EURO-LINE APPLIANCES WEST INC.

2912 West 4th Ave
Vancouver, BC V6K 1R2
Canada
Toll Free: 1.855.352-9378
Showroom: 604.235.3980
info@elawest.com